STATUTORY RULES OF NORTHERN IRELAND

2000 No. 169

EUROPEAN COMMUNITIES

ROAD TRAFFIC AND VEHICLES

Road Vehicles Lighting Regulations (Northern Ireland) 2000

Made - - - - *12th May 2000*

Coming into operation *1st July 2000*

The Department of the Environment, being a Department designated⁽¹⁾ for the purposes of section 2(2) of the European Communities Act 1972⁽²⁾ in relation to the construction and equipment of vehicles and of components of vehicles, in exercise of the powers conferred by that section, and in exercise of the powers conferred upon it by Articles 55(1), (2), (4), and (6) and Article 110(2) of the Road Traffic (Northern Ireland) Order 1995⁽³⁾ and of every other power enabling it in that behalf, hereby makes the following Regulations:

Part I

Preliminary

Citation and commencement

1. These Regulations may be cited as the Road Vehicles Lighting Regulations (Northern Ireland) 2000 and shall come into operation on 1st July 2000.

Interpretation

2.—(1) In these Regulations—

“the 1995 Order” means the Road Traffic (Northern Ireland) Order 1995;

“the Construction and Use Regulations” means the Motor Vehicles (Construction and Use) Regulations (Northern Ireland) 1999⁽⁴⁾;

(1) S.I. 1972/1811

(2) 1972 c. 68

(3) S.I. 1995/2994 (N.I. 18); see Article 2(2) for the definition of “the Department”

(4) S.R. 1999 No. 454

“the Designation of Approval Marks Regulations” means the Motor Vehicles (Designation of Approval Marks) Regulations 1979(5);

“agricultural vehicle” means a vehicle constructed or adapted for agriculture, grass cutting, forestry, land levelling, dredging or similar operations and primarily used for one or more of these purposes, and includes any trailer drawn by an agricultural vehicle;

“angles of visibility” means a requirement for a lamp or reflector fitted to a vehicle to have specified horizontal and vertical angles of visibility as a requirement that at least 50 per cent. of the apparent surface must be visible from any point within those angles when every door, tailgate, boot lid, engine cover, cab or other movable part of the vehicle is in the closed position;

“apparent surface” means for any given direction of observation, is the orthogonal projection of a light-emitting surface in a plane perpendicular to the direction of observation and touching that surface;

“articulated bus” has the same meaning as in regulation 2(1) of the Construction and Use Regulations;

“articulated vehicle” has the same meaning as in regulation 2(1) of the Construction and Use Regulations;

“breakdown vehicle” means a vehicle used to attend an accident or breakdown or to draw a broken down vehicle;

“bus” has the same meaning as in regulation 2(1) of the Construction and Use Regulations;

“caravan” means a trailer which is constructed (and not merely adapted) for human habitation;

“cc” means cubic centimetre or centimetres;

“circuit-closed tell-tale” means a light showing that a device has been switched on;

“cm²” means square centimetre or centimetres;

“cm” means centimetre or centimetres;

“combat vehicle” means a vehicle of a type described at item 1, 2 or 3 in column 1 of Schedule 1 to the Motor Vehicles (Authorisation of Special Types) Order 1997(6);

“Community Directive 76/756/EEC, as last amended by Directive 89/278/EEC” means Council Directive [76/756/EEC](#) of 27.7.76 (O.J. No. L262, 27.9.76, p. 1) as amended by Commission Directive [80/233/EEC](#) of 21.11.79 (O.J. No. L51, 25.2.80, p. 8), Commission Directive [82/244/EEC](#) of 17.3.82 (O.J. No. L109, 22.4.82, p. 31), Council Directive [83/276/EEC](#) of 26.5.83 (O.J. No. L151, 9.6.83, p. 47), Commission Directive [84/8/EEC](#) of 14.12.83 (O.J. No. L9, 12.1.84, p. 24) and Commission Directive [89/278/EEC](#) of 23.3.89 (O.J. No. L109, 20.4.89, p. 38);

“Community Directive 76/756/EEC, as last amended by Directive 91/663/EEC” means Council Directive [76/756/EEC](#) as last amended by Directive [89/278/EEC](#) and further amended by Commission Directive [91/663/EEC](#) (O.J. No. L366, 31.12.91, p. 17);

“cycle” has the same meaning as in Article 2(2) of the 1995 Order;

“daytime hours” means the time between half an hour before sunrise and half an hour after sunset;

“dim-dip device” means a device which is capable of causing a dipped-beam headlamp to operate at reduced intensity;

“dipped beam” means a beam of light emitted by a lamp which illuminates the road ahead of the vehicle without causing undue dazzle or discomfort to oncoming drivers or other road users;

(5) [S.I. 1979/1088](#); relevant amending instruments are [S.I. 1982/1479](#), [1983/1602](#), [1985/113](#) and [1986/369](#)

(6) [S.R. 1997 No. 109](#)

“direction indicator” means a lamp on a vehicle used to indicate to other road users that the driver intends to change direction to the right or to the left;

“dual-carriageway road” means a dual-carriageway within the meaning given in Part IV of the Schedule to the Motor Vehicles (Speed Limits) Regulations (Northern Ireland) 1989(7);

“dual-purpose vehicle” has the same meaning as in Article 2(2) of the Order of 1981;

“Education and Library Board” has the same meaning as in Article 3(1) of the Education and Libraries (Northern Ireland) Order 1986(8);

“emergency vehicle” means a motor vehicle of any of the following descriptions—

- (a) a vehicle used for fire brigade, ambulance or police purposes;
- (b) an ambulance, being a vehicle (other than an invalid carriage) which is constructed or adapted for the purposes of conveying sick, injured or disabled persons and which is used for such purposes;
- (c) a cardiac response vehicle, being a vehicle used only for the purposes of transporting medical or nursing personnel and equipment to cardiac incidents;
- (d) a vehicle owned by a body formed primarily for the purposes of fire salvage and used for those or similar purposes;
- (e) a vehicle owned by Department of Agriculture and used from time to time for the purposes of fighting fires;
- (f) a vehicle owned by the Secretary of State for Defence and used—
 - (i) for the purposes of the disposal of bombs or explosives,
 - (ii) by the Naval Emergency Monitoring Organisation for the purposes of a nuclear accident or an incident involving radioactivity,
 - (iii) by the Royal Air Force Mountain Rescue Service for the purposes of rescue operations or any other emergencies, or
 - (iv) by the Royal Air Force Armament Support Unit;
- (g) a vehicle primarily used for the purposes of the Blood Transfusion Service provided under Article 10(1)(d) of the Health and Personal Social Services (Northern Ireland) Order 1972(9);
- (h) a vehicle used by Her Majesty’s Coastguard or Coastguard Auxiliary Service for the purposes of giving aid to persons in danger or vessels in distress on or near the coast;
- (i) a vehicle owned by the Royal National Lifeboat Institution and used for the purposes of launching lifeboats, and
- (j) a vehicle primarily used for the purposes of conveying any human tissue for transplanting or similar purposes;

“end-outline marker lamp” means a lamp fitted near the outer edge of a vehicle in addition to the front and rear position lamps to indicate the presence of a wide vehicle;

“engineering plant” has the same meaning as in regulation 2(2) of the Construction and Use Regulations;

“extreme outer edge” means, in relation to a side of a vehicle, the vertical plane parallel with the longitudinal axis of the vehicle, and coinciding with its lateral outer edge, disregarding the projection of—

- (a) so much of the distortion of any tyre as is caused by the weight of the vehicle,

(7) S.R. 1989 No. 203

(8) S.I. 1986/594 (N.I. 3)

(9) S.I. 1972/1265 (N.I. 14)

- (b) any connections for tyre pressure gauges,
- (c) any anti-skid devices which may be mounted on the wheels,
- (d) rear-view mirrors,
- (e) lamps and reflectors,
- (f) customs seals affixed to the vehicle, and devices for securing and protecting such seals, and
- (g) special equipment;

“front fog lamp” means a lamp used to improve the illumination of the road in front of a motor vehicle in conditions of seriously reduced visibility;

“front position lamp” means a lamp used to indicate the presence and width of a vehicle when viewed from the front;

“first used” shall be construed in accordance with regulation 2(4) of the Construction and Use Regulations;

“hazard warning signal device” means a device which is capable of causing all the direction indicators with which a vehicle, or a combination of vehicles, is fitted to operate simultaneously;

“headlamp” means a lamp used to illuminate the road in front of a vehicle and which is not a front fog lamp;

“headlamp levelling device” means either—

- (a) an automatic headlamp levelling device by means of which the downward inclination of any dipped-beam headlamp is automatically maintained regardless of the load on the vehicle, or
- (b) a manual headlamp levelling device by means of which the downward inclination of any dipped-beam headlamp may be adjusted by a manual control operable from the driving seat of the vehicle;

“home forces” means the naval, military or air forces of Her Majesty raised in the United Kingdom;

“home forces vehicle” means a vehicle owned by, or in the service of, the home forces and used for naval, military or air force purposes;

“horse-drawn” means, in relation to a vehicle, that the vehicle is drawn by a horse or other animal;

“hours of darkness” means the time between half an hour after sunset and half an hour before sunrise;

“illuminated area” means—

- (a) in relation to a headlamp, front fog lamp and reversing lamp, in each case fitted with a reflector, the orthogonal projection of the full aperture of the reflector on a plane (touching the surface of the lamp) at right angles to the longitudinal axis of the vehicle to which the lamp is fitted. If the light emitting surface extends over only part of the full aperture of the reflector, then the projection of only that part shall be taken into account. In the case of a dipped-beam headlamp, the illuminated area is limited by the apparent trace of the cut-off on the lens;
- (b) in relation to any other lamp, the part of the orthogonal projection of the light-emitting surface on a plane (touching the surface of the lamp) at right angles to the longitudinal axis of the vehicle to which it is fitted, the boundary of which is such that if the straight edge of an opaque screen touches it at any point 98 per cent. of the total intensity of the light is shown in the direction parallel to the longitudinal axis of the vehicle. Accordingly,

for the purposes of determining the lower, upper and lateral edges of the lamp, only a screen placed with its straight edge horizontally or vertically needs to be considered;

“industrial tractor” has the same meaning as in regulation 2(1) of the Construction and Use Regulations;

“installation and performance requirements” means, in relation to any lamp, reflector, rear marking or device, the requirements specified in the Schedules to these Regulations relating to that lamp, reflector, rear marking or device;

“invalid carriage” means a mechanically propelled vehicle constructed or adapted for the carriage of one person, being a person suffering from some physical defect or disability;

“kerbside weight” has the same meaning as in regulation 2(1) of the Construction and Use Regulations;

“kg” means kilogram or kilograms;

“light-emitting surface” means, in relation to a lamp, that part of the exterior surface of the lens through which light is emitted when the lamp is lit, and in relation to a retro reflector that part of the exterior surface of the retro reflector from which light can be reflected;

“m” means metre or metres;

“main beam” means a beam of light emitted by a headlamp which illuminates the road over a long distance ahead of the vehicle;

“matched pair” means, in relation to lamps, a pair of lamps in respect of which—

- (a) both lamps emit light of substantially the same colour and intensity, and
- (b) both lamps are of the same size and of such a shape that they are symmetrical to one another;

“maximum distance from the side of the vehicle” means—

- (a) in relation to a lamp fitted to a vehicle, the shortest distance from the boundary of the illuminated area to an extreme outer edge of the vehicle, and
- (b) in relation to a retro reflector fitted to a vehicle, the shortest distance from the boundary of the reflecting area to an extreme outer edge of the vehicle;

“maximum gross weight” has the same meaning as in regulation 2(1) of the Construction and Use Regulations;

“maximum height above the ground” means the height above which no part of the illuminated area in the case of a lamp, or the reflecting area in the case of a retro reflector, extends when the vehicle is at its kerbside weight and when each tyre with which the vehicle is fitted is inflated to the pressure recommended by the manufacturer of the vehicle;

“maximum speed” has the same meaning as in regulation 2(1) of the Construction and Use Regulations;

“minimum height above the ground” means the height below which no part of the illuminated area in the case of a lamp, or the reflecting area in the case of a retro reflector, extends when the vehicle is at its kerbside weight and when each tyre with which the vehicle is fitted is inflated to the pressure recommended by the manufacturer of the vehicle;

“mm” means millimetre or millimetres;

“motor bicycle combination” means a combination of a solo motor bicycle and a sidecar;

“motor tractor” has the same meaning as in Article 3(1) of the 1995 Order;

“motorway” means a road designated as a special road under Article 15 of the Roads (Northern Ireland) Order 1993(10);

“movable platform” means a platform which is attached to, and may be moved by means of, an extendible boom;

“mph” means mile per hour or miles per hour;

“obligatory” means, in relation to a lamp, reflector, rear marking or device, a lamp, reflector, rear marking or device with which a vehicle, its load or equipment is required by these Regulations to be fitted;

“operational tell-tale” means a warning device readily visible or audible to the driver and showing whether a device that has been switched on is operating correctly or not;

“optional” means, in relation to a lamp, reflector, rear marking or device, a lamp, reflector, rear marking or device with which a vehicle, its load or equipment is not required by these Regulations to be fitted;

“overall length” has the same meaning as in regulation 2(1) of the Construction and Use Regulations;

“overall width” has the same meaning as in regulation 2(1) of the Construction and Use Regulations;

“pair” means, in relation to lamps, reflectors or rear markings a pair of lamps, reflectors or rear markings, including a matched pair, one on each side of the vehicle, in respect of which the following conditions are met—

- (a) each lamp, reflector or rear marking is at the same height above the ground, and
- (b) each lamp, reflector or rear marking is at the same distance from the extreme outer edge of the vehicle;

In the case of an asymmetric vehicle, these conditions shall be deemed to be met if they are as near as practicable to being met;

“passenger vehicle” has the same meaning as in regulation 2(1) of the Construction and Use Regulations;

“pedal retro reflector” means a retro reflector attached to or incorporated in the pedals of a cycle or motor bicycle;

“pedestrian-controlled vehicle” has the same meaning as in regulation 2(1) of the Construction and Use Regulations;

“prescribed sign” means a sign which is of a type shown in Schedule 22 and complies with the requirements of that Schedule;

“rear fog lamp” means a lamp used to render a vehicle more readily visible from the rear in conditions of seriously reduced visibility;

“rear position lamp” means a lamp used to indicate the presence and width of a vehicle when viewed from the rear;

“rear retro reflector” means a retro reflector used to indicate the presence and width of a vehicle when viewed from the rear;

“rear registration plate lamp” means a lamp used to illuminate the rear registration plate;

“reflecting area” means, in relation to a retro reflector fitted to a vehicle, the area of the orthogonal projection on a vertical plane (touching the surface of the reflector)—

- (a) at right angles to the longitudinal axis of the vehicle of that part of the reflector designed to reflect light in the case of a front or a rear retro reflector, and
- (b) parallel to the longitudinal axis of the vehicle of that part of the reflector designed to reflect light in the case of a side retro reflector;

“reversing lamp” means a lamp used to illuminate the road to the rear of a vehicle for the purpose of reversing and to warn other road users that the vehicle is reversing or about to reverse;

“road clearance vehicle” means a mechanically propelled vehicle used for dealing with frost, ice or snow on roads;

“running lamp” means a lamp (not being a front position lamp, an end-outline marker lamp, headlamp or front fog lamp) used to make the presence of a moving motor vehicle readily visible from the front;

“separation distance” means, in relation to two lamps or two retro reflectors, except where otherwise specified, the shortest distance between the orthogonal projections in a plane perpendicular to the longitudinal axis of the vehicle of the illuminated areas of the two lamps or the reflecting areas of the two reflectors;

“service braking system” has the same meaning as in regulation 2(1) of the Construction and Use Regulations;

“side marker lamp” means a lamp fitted to the side of a vehicle or its load and used to render the vehicle more visible to other road users;

“side retro reflector” means a reflector fitted to the side of a vehicle or its load and used to render the vehicle more visible from the side;

“solo motor bicycle” means a motor bicycle without a sidecar;

“special equipment” means a movable platform fitted to a vehicle, the apparatus for moving the platform and any jacks fitted to the vehicle for stabilising it while the movable platform is in use;

“special warning lamp” means a lamp, fitted to the front or rear of a vehicle, capable of emitting a blue flashing light and not any other kind of light;

“stop lamp” means a lamp used to indicate to road users that the brakes of a vehicle or combination of vehicles are being applied;

“traffic sign” has the same meaning as in Article 2(2) of the 1995 Order;

“trailer” means a vehicle constructed or adapted to be drawn by another vehicle;

“unladen weight” has the same meaning as in regulation 2(1) of the Construction and Use Regulations;

“vehicle in the service of a visiting force or of a headquarters” has the same meaning as in regulation 2(1) of the Construction and Use Regulations;

“visiting vehicle” means a vehicle brought temporarily into Northern Ireland by a person resident outside the United Kingdom;

“warning beacon” means a lamp that is capable of emitting a flashing or rotating beam of light throughout 360° in the horizontal plane;

“wheel” has the same meaning as in regulation 2(1) of the Construction and Use Regulations (see also paragraph (6));

“wheeled” has the same meaning as in regulation 2(1) of the Construction and Use Regulations;

“work lamp” means a lamp used to illuminate a working area or the scene of an accident, breakdown or roadworks in the vicinity of the vehicle to which it is fitted;

“s trailer” has the same meaning as in regulation 2(1) of the Construction and Use Regulations.

“works truck” has the same meaning as in regulation 2(1) of the Construction and Use Regulations.

(2) Material designed primarily to reflect light is, when reflecting light, to be treated for the purposes of these Regulations as showing a light, and material capable of reflecting an image is not, when reflecting the image of a light, to be so treated.

(3) In these Regulations a reference to one lamp, except in the case of a dipped-beam headlamp, a main-beam headlamp and a front fog lamp, includes any combination of two or more lamps, whether identical or not, having the same function and emitting light of the same colour, if it comprises devices the aggregate illuminated area of which occupies 60 per cent. or more of the area of the smallest rectangle circumscribing those illuminated areas.

(4) In these Regulations a reference to two lamps includes—

- (a) a single illuminated area which—
 - (i) is placed symmetrically in relation to the longitudinal axis of the vehicle,
 - (ii) extends on both sides to within 400 mm of the extreme outer edge of the vehicle,
 - (iii) is not less than 800 mm long, and
 - (iv) is illuminated by not less than two sources of light, and
- (b) any number of illuminated areas which—
 - (i) are juxtaposed,
 - (ii) if on the same transverse plane have illuminated areas which occupy not less than 60 per cent. of the area of the smallest rectangle circumscribing their illuminated areas,
 - (iii) are placed symmetrically in relation to the median longitudinal plane of the vehicle,
 - (iv) extend on both sides to within 400 mm of the extreme outer edge of the vehicle, do not have a total length of less than 800mm, and are illuminated by not less than two sources of light.

(5) Where a part fitted to a vehicle is required by these Regulations to be marked with a British Standard mark, the requirements shall not be regarded as met unless, in addition to being marked as required, the part complied with the relevant British Standard at the time when the part was first fitted to the vehicle.

(6) A reference in these Regulations to the number of wheels of a vehicle shall be construed in accordance with regulation 2 of the Construction and Use Regulations.

(7) A reference in a Schedule to there being no requirement in relation to a lamp, reflector, rear marking or device is without prejudice to any other provision in these Regulations affecting same.

Equivalent standards

3.—(1) Nothing in these Regulations shall render unlawful any act or omission which would have been lawful were—

- (a) there to be substituted for any reference to a British Standard in these Regulations a reference to a corresponding standard; and
- (b) regulation 2(5) to apply in relation to that corresponding standard and the markings relating to that corresponding standard as it applies to a British Standard.

(2) For the purposes of this regulation, “corresponding standard”, in relation to a relevant British Standard Specification, means—

- (a) a standard or code of practice of a national standards body or equivalent body of any State within the European Economic Area;
- (b) any international standard recognised for use as a standard by any State within the European Economic Area;

- (c) a technical specification or code of practice which, whether mandatory or not, is recognised for use as a standard by a public authority of any State within the European Economic Area,

where the standard, code of practice, international standard or technical specification provides, in relation to lamps, retro reflectors and rear markings, a level of safety equivalent to that provided by that British Standard Specification and contains a requirement as respects the marking of such parts equivalent to that provided by that instrument.

Exceptions — general

4.—(1) Where a provision is applied by these Regulations to a motor vehicle first used on or after a specified date it does not apply to any vehicle manufactured at least six months before that date.

(2) Where an exception from, or a relaxation of, a provision is applied by these Regulations to a motor vehicle first used before a specified date it shall also apply to a motor vehicle first used on or after that date if it was manufactured at least six months before that date.

(3) Nothing in these Regulations shall require any lamp or reflector to be fitted between sunrise and sunset to—

- (a) a vehicle not fitted with any front or rear position lamp;
- (b) an incomplete vehicle proceeding to a works for completion;
- (c) a cycle;
- (d) a pedestrian-controlled vehicle;
- (e) a horse-drawn vehicle;
- (f) a vehicle drawn or propelled by hand; or
- (g) a combat vehicle.

(4) Without prejudice to regulation 19, for the purposes of these regulations a lamp shall not be treated as being a lamp if it is—

- (a) so painted over or masked that it is not capable of being immediately used or readily put to use; or
- (b) an electric lamp which is not provided with any system of wiring by means of which that lamp is, or can readily be, connected with a source of electricity.

Exceptions — temporarily imported vehicles and vehicles proceeding to a port for export

5. Part II of these Regulations does not apply to—

- (a) any vehicle brought into Northern Ireland and originating from a base or centre in a country outside Northern Ireland from which the use of the vehicle on a journey is normally commenced, a period of 12 months not having elapsed since the vehicle in question was last brought into Northern Ireland;
- (b) a visiting vehicle;
- (c) any combination of two or more vehicles, one of which is drawing the other or others, if the combination included any vehicle of the type mentioned in sub-paragraph (a) or (b); or
- (d) a vehicle proceeding to a port for export, if in each case the vehicle or combination of vehicles complies in every respect with the requirements about lighting equipment and reflectors relating thereto contained in the Convention on Road Traffic concluded at Geneva on 19th September 1949⁽¹¹⁾ or the International Convention relating to Motor Traffic concluded at Paris on 24th April 1926⁽¹²⁾.

Exceptions — vehicles towing or being towed

6.—(1) A motor vehicle first used before 24th January 1996 and a cycle or trailer manufactured before 24th January 1996 shall not be required by regulation 21 to be fitted with any rear position lamp, stop lamp, rear direction indicator, rear fog lamp or rear reflector whilst a trailer fitted with any such lamp or reflector is attached to its rear.

(2) A trailer manufactured before 24th January 1996 shall not be required by regulation 21 to be fitted with any front position lamp whilst being drawn by a passenger vehicle.

(3) A trailer shall not be required by regulation 21 to be fitted with any stop lamp whilst being drawn by a vehicle which is not required by regulation 21 to be fitted with any such lamp.

(4) Paragraph (3) shall apply respectively to rear fog lamps and direction indicators as it applies to stop lamps.

(5) A trailer manufactured before 24th January 1996 shall not be required by regulation 21 to be fitted with any stop lamp or direction indicator whilst being drawn by a motor vehicle fitted with one or two stop lamps and two or more direction indicators if the dimensions of the trailer are such that when the longitudinal axes of the drawing vehicle and the trailer lie in the same vertical plane such stop lamps and at least one direction indicator on each side of the vehicle are visible to an observer in that vertical plane from a point 6m behind the rear of the trailer whether it is loaded or not.

(6) Rear markings shall not be required to be fitted to any vehicle by regulation 21 if another vehicle in a combination of which it forms part would obscure any such marking.

(7) Where a broken-down vehicle is being drawn by another vehicle—

(a) regulations 21 and 26 shall not apply to the broken-down vehicle between sunrise and sunset, and

(b) between sunset and sunrise those regulations shall apply to the broken-down vehicle only in respect of rear position lamps and reflectors.

(8) The references in paragraphs (3) and (4) to a vehicle which is required to be fitted with a lamp shall be construed as if paragraph (1) did not have effect.

Exceptions — customs vehicles

7.—(1) A vehicle under the control of the Collector of Customs and Excise, Northern Ireland Collection, shall be exempt from the requirements of regulations 27 and 28 while it is on patrol within three miles of the land frontier of Northern Ireland, if the said Collector has certified that such exemption is necessary in the case of that vehicle for the purpose of enforcing the Customs Acts.

(2) Paragraph (1) shall not affect any civil claim for injury or damage to person or property.

Exceptions — police vehicles

8.—(1) A vehicle under the control of the Chief Constable shall be exempt from the requirements of regulations 27 and 28 while it is on patrol within three miles of the land frontier of Northern Ireland, if a Superintendent of the Royal Ulster Constabulary has certified that such exemption is necessary in the case of that vehicle for the purpose of enforcing the law.

(2) Paragraph (1) shall not affect any civil claim for injury or damage to person or property.

Exceptions — military vehicles

9.—(1) Regulation 21 does not apply to a home forces' vehicle or to a vehicle in the service of a visiting force or of a headquarters whilst being used—

- (a) in connection with training which is certified in writing for the purposes of this regulation by a person duly authorised in that behalf to be training on a special occasion and of which not less than 48 hours notice has been given by that person to the Chief Constable; or
- (b) on manoeuvres within such limits and during such period as may from time to time be specified by Order in Council under the Manoeuvres Act 1958(13).

(2) Where not less than 6 and not more than 12 vehicles being home forces' vehicles or vehicles of a visiting force or of a headquarters are proceeding together in a convoy on tactical or driving exercises which are authorised in writing by a person duly authorised in that behalf, and of which not less than 48 hours notice in writing has been given by that person to the Chief Constable and the interval between any two vehicles in such a convoy does not exceed 20m—

- (a) front position lamps shall be required only on the vehicle leading the convoy; and
- (b) rear position lamps shall be required only on the rearmost vehicle provided that every other vehicle in the convoy carries a bright light under the vehicle illuminating either a part of the vehicle or anything attached to the vehicle or the road surface beneath the vehicle in such a manner that the presence of the vehicle can be detected from the rear.

(3) No lamp is required to be fitted to any home forces' vehicle or any vehicle in the service of a visiting force or of a headquarters if the vehicle is constructed or adapted for combat and is such that compliance with these provisions is impracticable and it is fitted with two red rear position lamps and two red rear retro reflectors when on a road between sunset and sunrise. Such lamps and reflectors need not meet any of the requirements specified in Schedules 10 and 18.

(4) Part II of these Regulations does not apply to a vehicle in the service of a visiting force or of a headquarters if the vehicle complies in every respect with the requirements as to lighting equipment and reflectors thereto contained in a Convention referred to in regulation 5.

(5) A home forces' vehicle shall while used in conjunction with operations of the Royal Ulster Constabulary be exempt from the requirements of regulations 27 and 28 if an authorising officer has certified that such exemption is necessary in the case of that vehicle for the purpose of assistance in enforcing the law.

(6) Paragraph (5) shall not affect any civil claim for injury or damage to person or property.

(7) For the purposes of this regulation “authorising officer” means an officer of the home forces of a rank not lower than that of Captain Royal Navy, Colonel or Group Captain.

Exceptions — invalid carriages

10. An invalid carriage having a maximum speed not exceeding 4 mph is required by these Regulations to be fitted with lamps and reflectors only when it is used on the carriageway of a road between sunset and sunrise otherwise than for the sole purpose of crossing it.

Exceptions — vehicles drawn or propelled by hand

11. A vehicle drawn or propelled by hand which has an overall width, including any load, not exceeding 800 mm is required by these Regulations to be fitted with lamps and reflectors only when it is used on the carriageway of a road between sunset and sunrise other than—

- (a) close to the near side or left-hand edge of the carriageway, or
- (b) to cross the carriageway.

Provision as respects Trade Descriptions Act 1968

12. Where by any provision in these Regulations any vehicle or any of its parts or equipment is required to be marked with a specification number or a mark of the British Standards Institution or any approval mark, nothing in that provision shall be taken to authorise any person to apply any such number or mark to the vehicle, part or equipment in contravention of the Trade Descriptions Act 1968(14).

Part II

Regulations governing the fitting of Lamps, Reflectors, Rear Markings and Devices

Colour of light shown by lamps and reflectors

13.—(1) A vehicle shall not be fitted with a lamp or retro reflective material which is capable of showing a red light to the front, except—

- (a) a red and white chequered domed lamp, or a red and white segmented mast-mounted warning beacon, fitted to a fire service control vehicle and intended for use at the scene of an emergency;
- (b) a side marker lamp or a side retro reflector;
- (c) retro reflective material or a retro reflector designed primarily to reflect light to one or both sides of the vehicle and attached to or incorporated in any wheel or tyre of—
 - (i) a cycle and any sidecar attached to it;
 - (ii) a solo motor bicycle or a motor bicycle combination; or
 - (iii) an invalid carriage; or
- (d) a traffic sign.

(2) A vehicle shall not be fitted with a lamp or retro reflective material which is capable of showing any light to the rear, other than a red light, except—

- (a) amber light from a direction indicator or side marker lamp;
- (b) white light from a reversing lamp;
- (c) white light from a work lamp;
- (d) light to illuminate the interior of a vehicle;
- (e) light from an illuminated rear registration plate;
- (f) light for the purposes of illuminating a taxi meter;
- (g) in the case of a bus, light for the purposes of illuminating a route indicator;
- (h) blue light and white light from a chequered domed lamp fitted to a police control vehicle and intended for use at the scene of an emergency;
- (i) white light from a red and white chequered domed lamp, or a red and white segmented mast-mounted warning beacon, fitted to a fire service control vehicle and intended for use at the scene of an emergency;
- (j) green light and white light from a chequered domed lamp fitted to an ambulance control vehicle and intended for use at the scene of an emergency;
- (k) blue light from a warning beacon or rear special warning lamp fitted to an emergency vehicle, or from any device fitted to a vehicle used for police purposes;

- (l) amber light from a warning beacon fitted to—
 - (i) a road clearance vehicle;
 - (ii) a vehicle constructed or adapted for the purpose of collecting refuse;
 - (iii) a breakdown vehicle;
 - (iv) a vehicle having a maximum speed not exceeding 25 mph or any trailer drawn by such a vehicle;
 - (v) a vehicle having an overall width (including any load) exceeding 2.9 m;
 - (vi) a vehicle used for the purposes of testing, maintaining, improving, cleansing, gritting, salting or watering roads or for any purpose incidental to any such use;
 - (vii) a vehicle used for the purpose of inspecting, cleansing, maintaining, adjusting, renewing or installing any apparatus which is in, on, under or over a road, or for any purpose incidental to any such use;
 - (viii) a vehicle used for or in connection with any purpose for which it is authorised to be used on roads by an order under Article 60 of the 1995 Order;
 - (ix) a vehicle used for escort purposes when travelling at a speed not exceeding 25 mph;
 - (x) a vehicle used by the Commissioners of Customs and Excise for the purpose of testing fuels;
 - (xi) a vehicle used for the purpose of surveying;
 - (xii) a vehicle used for the removal or immobilisation of vehicles in exercise of a statutory power or duty;
- (m) green light from a warning beacon fitted to a vehicle used by a medical practitioner registered by the General Medical Council (whether with full, provisional or limited registration);
- (n) yellow light from a warning beacon fitted to a vehicle for use at airports;
- (o) light of any colour from a traffic sign which is attached to a vehicle;
- (p) reflected light from amber pedal retro reflectors;
- (q) reflected light of any colour from retro reflective material or a retro reflector designed primarily to reflect light to one or both sides of the vehicle and attached to or incorporated in any wheel or tyre of—
 - (i) a cycle and any sidecar attached to it;
 - (ii) a solo motor bicycle or motor bicycle combination; or
 - (iii) an invalid carriage;
- (r) reflected light from amber retro reflective material on a road clearance vehicle;
- (s) reflected light from yellow retro reflective registration plates;
- (t) reflected light from yellow retro reflective material incorporated in a prescribed rear marking fitted in the appropriate manner to—
 - (i) a motor vehicle having a maximum gross weight exceeding 7500 kg;
 - (ii) a motor vehicle first used before 1st July 1983 having an unladen weight exceeding 3000 kg;
 - (iii) a trailer having a maximum gross weight exceeding 3500 kg;
 - (iv) a trailer manufactured before 1st July 1983 having an unladen weight exceeding 1000 kg;

- (v) a trailer which forms part of a combination of vehicles one of which is of a type mentioned in a previous item of this sub-paragraph;
 - (vi) a load carried by any vehicle;
 - (u) reflected light from orange retro reflective material incorporated in a sign fitted to the rear of a vehicle carrying a dangerous substance within the meaning of the Road Traffic (Carriage of Dangerous Substances in Road Tankers and Tank Containers) Regulations (Northern Ireland) 1992⁽¹⁵⁾ or the Road Traffic (Carriage of Dangerous Substances in Packages etc.) Regulations (Northern Ireland) 1992⁽¹⁶⁾;
 - (v) reflected light from yellow retro reflective material incorporated in a prescribed sign and fitted to the rear of a bus;
 - (w) reflected light from yellow retro reflective material incorporated in a sign fitted to the rear of a bus in accordance with paragraph (4); or
 - (x) reflected light from orange or yellow retro reflective material fitted to the rear of a vehicle used for police purposes.
- (3) For the purposes of paragraph (2)(t), a rear marking fitted to a vehicle is a prescribed rear marking fitted in the appropriate manner if the rear marking—
- (a) is a rear marking of a description specified in the entry applicable to that vehicle in the right hand column of paragraph 1 of Part I of Schedule 19, and
 - (b) complies with paragraphs 2 to 7 of that Part of that Schedule.
- (4) For the purposes of paragraph (2)(w), a sign (“the secondary sign”) is fitted to the rear of a bus in accordance with this paragraph if—
- (a) a prescribed sign is also fitted to the rear of the bus;
 - (b) the total area of the retro reflective material incorporated in the secondary sign is no greater than the area of the prescribed sign; and
 - (c) the secondary sign satisfies the requirements specified—
 - (i) in the case of a bus which is owned or hired by an Education and Library Board or any person managing an education establishment attended by children under the age of 16 years, in paragraph (5) or (6); or
 - (ii) in any other case, in paragraph (6).
- (5) The requirements referred to in paragraph (4)(c)(i) are that the secondary sign contains no words or other markings apart from words or markings identifying the Education and Library Board or the educational establishment.
- (6) The requirements referred to in paragraph (4)(c)(ii) are that the secondary sign contains no words or other markings apart from words or other markings which—
- (a) indicate that children are on board the bus when it is in motion or likely to be on board the bus or in its vicinity when it is stationary, and
 - (b) are calculated to reduce the risk of road accidents involving such children.

Movement of lamps and reflectors

14.—(1) Save as provided in paragraph (2), a person shall not use, or cause or permit to be used, on a road any vehicle to which, or to any load or equipment of which, there is fitted a lamp, reflector or marking which is capable of being moved by swivelling, deflecting or otherwise while the vehicle is in motion.

⁽¹⁵⁾ S.R. 1992 No. 260

⁽¹⁶⁾ S.R. 1992 No. 261

- (2) Paragraph (1) does not apply in respect of—
- (a) a headlamp which can be dipped only by the movement of the headlamp or its reflector;
 - (b) a headlamp which is capable of adjustment so as to compensate for the effect of the load carried by the vehicle;
 - (c) a lamp or reflector which can be deflected to the side by the movement of, although not necessarily through the same angle as, the front wheel or wheels of the vehicle when turned for the purpose of steering the vehicle;
 - (d) a headlamp or front fog lamp which can be wholly or partially retracted or concealed;
 - (e) a direction indicator fitted to a motor vehicle first used before 24th January 1996 ;
 - (f) a work lamp;
 - (g) a warning beacon;
 - (h) an amber pedal retro reflector; or
 - (i) retro reflective material or a retro reflector of any colour which is fitted so as to reflect light primarily to one or both sides of the vehicle and is attached to or incorporated in any wheel or tyre of—
 - (i) a cycle and any sidecar attached thereto;
 - (ii) a solo motor bicycle or motor bicycle combination; or
 - (iii) an invalid carriage.

Lamps to show a steady light

15.—(1) Save as provided in paragraph (2), a vehicle shall not be fitted with a lamp which automatically emits a flashing light.

- (2) Paragraph (1) does not apply in respect of—
- (a) a direction indicator;
 - (b) a headlamp fitted to an emergency vehicle;
 - (c) a warning beacon or special warning lamp;
 - (d) a lamp or illuminated sign fitted to a vehicle used for police purposes;
 - (e) a green warning lamp used as an anti-lock brake indicator; or
 - (f) lamps forming part of a traffic sign.

Filament lamps

16. Where a motor vehicle first used on or after 24th January 1996 or any trailer manufactured on or after 24th January 1996 is equipped with any lamp of a type that is required by any Schedule to these Regulations to be marked with an approval mark, no filament lamp other than a filament lamp referred to in the Designation of Approval Marks Regulations in—

- (a) regulation 4 and Schedule 2, items 2 or 2A, 8, 20, 37 or 37A; or
- (b) regulation 5 and Schedule 4, item 18,

to those Regulations, shall be fitted to any such vehicle.

Signs on buses carrying children

17.—(1) Subject to paragraph (2), a person shall not use or cause or permit to be used on a road a bus when it is carrying a child to or from his school unless—

- (a) a prescribed sign is fitted to the front of the bus and is plainly visible to road users ahead of the bus; and
 - (b) a prescribed sign is fitted to the rear of the bus and is plainly visible to road users behind the bus.
- (2) Paragraph (1) does not apply—
- (a) where a bus is on a bus service of a description specified in paragraph 2 of Schedule 18 (bus services specified for the purposes of regulation 56(5)) to the Construction and Use Regulations; or
 - (b) where a bus is the property of an Education and Library Board and is painted in the distinctive livery of that Board.
- (3) A prescribed sign shall be removed while any bus to which it has been fitted is being used for purposes other than carrying a child to or from his school.
- (4) For the purposes of this regulation—
- (a) a reference to a bus carrying a child to or from his school is a reference to a bus carrying a child—
 - (i) to, or to a place within the vicinity of, his school on a day during term time before he has attended the school on that day; or
 - (ii) from, or from a place within the vicinity of, his school on a day during term time after he has finished attending the school on that day;
 - (b) “school” has the same meaning as in Article 2(2) of the Education and Libraries (Northern Ireland) Order 1986(17); and
 - (c) a reference to a child is a reference to a child under the age of 16 years.

General requirements for electrical connections

18.—(1) Every motor vehicle first used on or after 24th January 1996 shall be so constructed that every position lamp, side marker lamp, end-outline marker lamp and rear registration plate lamp with which the vehicle is fitted is capable of being switched on and off by the operation of one switch and, save as provided in paragraph (2), not otherwise.

(2) Paragraph (1) shall not prevent one or more position lamps from being capable of being switched on and off independently of any other lamp referred to in that paragraph.

Restrictions on fitting blue warning beacons, special warning lamps and similar devices

19.—(1) Subject to paragraph (2), a vehicle shall not be fitted with—

- (a) a blue warning beacon or special warning lamp, or
- (b) a device which resembles a blue warning beacon or a special warning lamp, whether the same is in working order or not.

(2) Paragraph (1) shall not apply to an emergency vehicle.

Obligatory warning beacons

20.—(1) Subject to paragraph (2), a person shall not use, or cause or permit to be used, on an unrestricted dual-carriageway road any motor vehicle with four or more wheels having a maximum speed not exceeding 25 mph unless it or any trailer drawn by it is fitted with at least one warning beacon which—

- (a) complies with Schedule 16; and
 - (b) is showing an amber light.
- (2) Paragraph (1) shall not apply in relation to—
- (a) any motor vehicle first used before 1st January 1947; and
 - (b) any motor vehicle, or any trailer being drawn by it, to which paragraph (1) would otherwise apply, when that vehicle or trailer is on any carriageway of an unrestricted dual-carriageway road for the purpose only of crossing that carriageway in the quickest manner practicable in the circumstances.

Obligatory lamps, reflectors, rear markings and devices

21.—(1) Save as provided in the foregoing provisions of these Regulations and in paragraph (2), every vehicle of a class specified in a Table in Schedule 1 shall be fitted with lamps, reflectors, rear markings and devices which—

- (a) are of a type specified in column 1 of that Table, and
- (b) comply with the relevant installation, alignment and performance requirements set out in the Schedule or Part of a Schedule shown against that type in column 2 of that Table.

(2) The requirements specified in paragraph (1) do not apply in respect of a lamp, reflector, rear marking or device of a type specified in column 1 of a Table in the case of a vehicle shown against it in column 3 of that Table.

(3) The requirements specified in paragraph (1) apply without prejudice to any additional requirements specified in regulations 23 and 24.

(4) The Schedules referred to in the Tables in Schedule 1 are Schedules 2 to 21.

Restrictions on the obscuration of certain obligatory lamps and reflectors

22. Every vehicle shall be so constructed that at least part of the apparent surface of any—

- (a) front and rear position lamp;
- (b) front and rear direction indicator; and
- (c) rear retro reflector;

which is required by these Regulations to be fitted to a vehicle is visible when the vehicle is viewed from any point directly in front of or behind the lamp or reflector, as appropriate, when every door, tailgate, boot lid, engine cover, cab or other movable part of the vehicle is in a fixed open position.

Optional lamps, reflectors, rear markings and devices

23. Every optional lamp, reflector, rear marking or device fitted to a vehicle, being of a type specified in an item in column 2 of the Table, shall comply with the provisions shown in column 3.

TABLE

(1) <i>Item</i>	(2) <i>Type of lamp, reflector, rear marking or device</i>	(3) <i>Provisions with which compliance is required</i>
1.	Front position lamp	Schedule 2, Part II and Part I of Schedules 2 to 5, 7, 9 to 13 and

Status: This is the original version (as it was originally made). This item of legislation is currently only available in its original format.

(1) <i>Item</i>	(2) <i>Type of lamp, reflector, rear marking or device</i>	(3) <i>Provisions with which compliance is required</i>
2.	Dim-dip device and running lamp	Schedule 3, Part II
3.	Dipped-beam headlamp	Schedule 4, Part II
4.	Main-beam headlamp	Schedule 5, Part II
5.	Front fog lamp	Schedule 6
6.	Direction indicator	Schedule 7, Part II
7.	Hazard warning signal device	Schedule 8
8.	Side marker lamp	Schedule 9, Part II
9.	Rear position lamp	Schedule 10, Part II
10.	Rear fog lamp	Schedule 11, Part II
11.	Stop lamp	Schedule 12, Part II
12.	End-outline marker lamp	Schedule 13, Part II
13.	Reversing lamp	Schedule 14
14.	Warning beacon	Schedule 16
15.	Side retro reflector	Schedule 17, Part II
16.	Rear retro reflector	Schedule 18, Part II
17.	Rear marking	Schedule 19, Part II
18.	Pedal retro reflector	Schedule 20, Part II
19.	Front retro reflector	Schedule 21, Part II

Projecting trailers and vehicles carrying overhanging or projecting loads or equipment

24.—(1) A person shall not use, or cause or permit to be used, on a road in the circumstances mentioned in paragraph (2)—

- (a) any trailer which forms part of a combination of vehicles which projects laterally beyond any preceding vehicle in the combination; or
- (b) any vehicle or combination of vehicles which carries a load or equipment,

in either case under the conditions specified in an item in column 2 of the Table, unless the vehicle or combination of vehicles complies with the requirements specified in that item in column 3.

TABLE

(1) <i>Item</i>	(2) <i>Conditions</i>	(3) <i>Requirements</i>
1.	A trailer which is not fitted with front position lamps and which projects laterally on any side so that the distance from the outermost part of the projection to the outermost part of the illuminated area of the obligatory front position lamp on that side fitted to any preceding vehicle in the combination exceeds 400 mm.	A lamp showing white light to the front shall be fitted to the trailer so that the outermost part of the illuminated area is not more than 400 mm from the outermost projection of the trailer. The installation and performance requirements relating to front position lamps do not apply to any such lamp.
2.	A trailer which is not fitted with front position lamps and which carries a load or equipment which projects laterally on any side of the trailer so that the distance from the outermost projection of the load or equipment to the outermost part of the illuminated area of the obligatory front position lamp on that side fitted to any preceding vehicle in the combination exceeds 400 mm.	A lamp showing white light to the front shall be fitted to the trailer or the load or equipment so that the outermost part of the illuminated area is not more than 400 mm from the outermost projection of the load or equipment. The installation and performance requirements relating to front position lamps do not apply to any such lamp.
3.	A vehicle which carries a load or equipment which projects laterally on any side of the vehicle so that the distance from the outermost part of the load or equipment to the outermost part of the illuminated area of the obligatory front or rear position lamp on that side exceeds 400 mm.	<p>Either—</p> <p>(a) the obligatory front or rear position lamp shall be transferred from the vehicle to the load or equipment to which must also be attached a white front or a red rear reflecting device;</p> <p>or</p> <p>(b) an additional front or rear position lamp and a white front or a red rear reflecting device shall be fitted to the vehicle, load or equipment.</p> <p>All the installation, performance</p>

Status: This is the original version (as it was originally made). This item of legislation is currently only available in its original format.

(1) <i>Item</i>	(2) <i>Conditions</i>	(3) <i>Requirements</i>
		and maintenance requirements relating to front or rear position lamps shall in either case be complied with except that for the purpose of determining the lateral position of such lamps and reflecting devices any reference to the vehicle shall be taken to include the load or equipment except special equipment on a vehicle fitted with a movable platform or the jib of any crane.
4.	<p>A vehicle which carries a load or equipment which projects beyond the rear of the vehicle or, in the case of a combination of vehicles, beyond the rear of the rearmost vehicle in the combination, more than—</p> <p>(a) 2 m in the case of an agricultural vehicle or a vehicle carrying a fire escape; or</p> <p>(b) 1 m in the case of any other vehicle.</p>	<p>An additional rear lamp capable of showing red light to the rear and a red reflecting device, both of which are visible from a reasonable distance, shall be fitted to the vehicle or the load in such a position that the distance between the lamp and the reflecting device, and the rearmost projection of the load or equipment does not exceed 2 m in the case mentioned in sub-paragraph (a) in column 2 of this item or 1 m in any other case. The installation and performance requirements relating to rear position lamps and rear retro reflectors do not apply to any such additional lamp and reflecting device.</p>
5.	<p>A vehicle which carries a load or equipment which projects beyond the front of the vehicle more than—</p> <p>(a) 2 m in the case of an agricultural vehicle or a vehicle carrying a fire escape; or</p> <p>(b) 1 m in the case of any other vehicle.</p>	<p>An additional front lamp capable of showing white light to the front and a white reflecting device, both visible from a reasonable distance, shall be fitted to the vehicle or the load in such a position that the distance between the lamp and the reflecting device, and the foremost projection of the load or equipment, does not exceed 2 m in the case</p>

Status: This is the original version (as it was originally made). This item of legislation is currently only available in its original format.

(1) <i>Item</i>	(2) <i>Conditions</i>	(3) <i>Requirements</i>
6.	A vehicle which carries a load or equipment which obscures any obligatory lamp, reflector or rear marking.	<p>mentioned in sub-paragraph (a) in column 2 of this item or 1m in any other case. The installation and performance requirements relating to front position lamps and front retro reflectors do not apply to any such additional lamp and reflecting device.</p> <p>Either—</p> <p>(a) the obligatory lamp, reflector or rear marking shall be transferred to a position on the vehicle, load or equipment where it is not obscured; or</p> <p>(b) an additional lamp, reflector or rear marking shall be fitted to the vehicle, load or equipment. All the installation, performance and maintenance requirements relating to obligatory lamps, reflectors or rear markings shall in either case be complied with.</p>

(2) The circumstances referred to in paragraph (1) are—

- (a) as regards item 6 in the Table, in so far as it relates to obligatory stop lamps and direction indicators, all circumstances; and
- (b) as regards items 1 to 5 in the Table, and item 6 in the Table, except in so far as it relates to obligatory stop lamps and direction indicators, the time between sunset and sunrise or, except in so far as it relates to obligatory reflectors, when visibility is seriously reduced between sunrise and sunset.

Additional side marker lamps

25.—(1) Save as provided in paragraph (2), a person shall not use, or cause or permit to be used, on a road between sunset and sunrise, or in seriously reduced visibility between sunrise and sunset, any vehicle or combination of vehicles of a type specified in an item in column 2 of the Table unless each side of the vehicle or combination of vehicles is fitted with the side marker lamps specified in that item in column 3 and those lamps are kept lit.

Status: This is the original version (as it was originally made). This item of legislation is currently only available in its original format.

TABLE

(1) <i>Item</i>	(2) <i>Vehicle or combination of vehicles</i>	(3) <i>Side marker lamps</i>
1.	A vehicle or a combination of vehicles the overall length of which (including any load) exceeds 18.3 m.	<p>There shall be fitted—</p> <ul style="list-style-type: none"> (a) one lamp no part of the light-emitting surface of which is more than 9.15 m from the foremost part of the vehicle or vehicles (in either case inclusive of any load); (b) one lamp no part of the light-emitting surface of which is more than 3.05 m from the rearmost part of the vehicle or vehicles (in either case inclusive of any load); and (c) such other lamps as are required to ensure that not more than 3.05 m separates any part of the light-emitting surface of one lamp and any part of the light-emitting surface of the next lamp.
2.	A combination of vehicles the overall length of which (including any load) exceeds 12.2 m but does not exceed 18.3 m and carrying a load supported by any two of the vehicles but not including a load carried by an articulated vehicle.	<p>There shall be fitted—</p> <ul style="list-style-type: none"> (a) one lamp no part of the light-emitting surface of which is forward of, or more than 1530 mm rearward of, the rearmost part of the drawing vehicle; and (b) if the supported load extends more than 9.15 m rearward of the rearmost part of the

Status: This is the original version (as it was originally made). This item of legislation is currently only available in its original format.

(1) Item	(2) Vehicle or combination of vehicles	(3) Side marker lamps
		drawing vehicle, one lamp no part of the light-emitting surface of which is forward of, or more than 1530 mm rearward of, the centre of the length of the load.

- (2) The requirements specified in paragraph (1) do not apply to—
- (a) a combination of vehicles where any vehicle being drawn in that combination has broken down; or
 - (b) a vehicle (not being a combination of vehicles) having an appliance or apparatus or carrying a load of a kind specified in the Table to regulation 94(9) or in regulation 94(10) of the Construction and Use Regulations, if the conditions specified in paragraphs 3 and 4 (which provide for the special marking of projections from vehicles) of Schedule 15 to those Regulations are complied with in relation to the special appliance or apparatus or load as if the said conditions had been expressed in the said regulation 94 to apply in the case of every special appliance or apparatus or load of a kind specified in that regulation.
- (3) Every side marker lamp fitted in accordance with this regulation shall comply with Part I of Schedule 9.

Part III

Regulations Governing the Maintenance and Use of Lamps, Reflectors, Rear Markings and Devices

Maintenance of lamps, reflectors, rear markings and devices

26.—(1) A person shall not use, or cause or permit to be used, on a road a vehicle unless every lamp, reflector, rear marking and device to which this paragraph applies is in good working order and, in the case of a lamp, clean.

- (2) Save as provided in paragraph (3), paragraph (1) applies to—
- (a) every—
 - (i) front position lamp,
 - (ii) rear position lamp,
 - (iii) headlamp,
 - (iv) rear registration plate lamp,
 - (v) side marker lamp,
 - (vi) end-outline marker lamp,
 - (vii) rear fog lamp,
 - (viii) retro reflector, and

- (ix) rear marking of a type specified in Part III of Schedule 19, with which the vehicle is required by these Regulations to be fitted; and
- (b) every—
 - (i) stop lamp,
 - (ii) direction indicator,
 - (iii) running lamp,
 - (iv) dim-dip device,
 - (v) headlamp levelling device, and
 - (vi) hazard warning signal device,
 with which it is fitted.
- (3) Paragraph (2) does not apply to—
 - (a) a rear fog lamp on a vehicle which is part of a combination of vehicles any part of which is not required by these Regulations to be fitted with a rear fog lamp;
 - (b) a rear fog lamp on a motor vehicle drawing a trailer;
 - (c) a defective lamp, reflector, dim-dip device or headlamp levelling device on a vehicle in use on a road between sunrise and sunset, if any such lamp, reflector or device became defective during the journey which is in progress or if arrangements have been made to remedy the defect with all reasonable expedition; or
 - (d) a lamp, reflector, dim-dip device, headlamp levelling device or rear marking on a combat vehicle in use on a road between sunrise and sunset.

Requirements about the use of front and rear position lamps, rear registration plate lamps, side marker lamps and end-outline marker lamps

- 27.—**(1) Save as provided in paragraphs (5) and (9), no person shall—
- (a) use, or cause or permit to be used, on a road any vehicle which is in motion—
 - (i) between sunset and sunrise, or
 - (ii) in seriously reduced visibility between sunrise and sunset; or
 - (b) allow to remain at rest, or cause or permit to be allowed to remain at rest, on a road any vehicle between sunset and sunrise,

unless every front position lamp, rear position lamp, rear registration plate lamp, side marker lamp and end-outline marker lamp with which the vehicle is required by these Regulations to be fitted is kept lit and unobscured.

(2) Save as provided in paragraphs (5) and (9), where a solo motor bicycle is not fitted with a front position lamp, a person shall not use it, or cause or permit it to be used, on a road (other than when it is parked) between sunset and sunrise or in seriously reduced visibility between sunrise and sunset, unless a headlamp is kept lit and unobscured.

- (3) Save as provided in paragraphs (5) and (9), no person shall allow to remain parked, or cause or permit to be allowed to remain parked between sunset and sunrise—
- (a) a motor bicycle combination which is required to be fitted only with a front position lamp on the sidecar; or
 - (b) a trailer to the front of which no other vehicle is attached and which is not required to be fitted with front position lamps, unless a pair of front position lamps is fitted and kept lit and unobscured.

(4) Save as provided in paragraphs (5) and (9), no person shall allow to remain parked, or cause or permit to be allowed to remain parked between sunset and sunrise a solo motor bicycle which is not required to be fitted with a front position lamp, unless a front position lamp is fitted and kept lit and unobscured.

(5) Paragraphs (1), (2), (3) and (4) shall not apply in respect of a vehicle of a class specified in paragraph (7) which is parked on a road on which a speed limit of 30 mph or less is in force and the vehicle is parked—

- (a) in a parking place for which provision is authorised under Article 10(4) or designated under Article 15(1)(a) of the Road Traffic Regulation (Northern Ireland) Order 1997(18), or which is set apart as a parking place under some other enactment or instrument and the vehicle is parked in a manner which does not contravene the provision of any enactment or instrument relating to the parking place; or
- (b) in a lay-by—
 - (i) the limits of which are indicated by a traffic sign consisting of the road marking shown in diagram 1010 of Schedule 6 of the Traffic Signs Regulations (Northern Ireland) 1997(19); or
 - (ii) the surface of which is of a colour or texture which is different from that of the part of the carriageway of the road used primarily by through traffic; or
 - (iii) the limits of which are indicated by a continuous strip of surface of a different colour or texture from that of the surface of the remainder of the carriageway of the road; or
- (c) elsewhere than in such a parking place or lay-by if—
 - (i) the vehicle is parked in one of the circumstances described in paragraph (8); and
 - (ii) no part of the vehicle is less than 15 m in from the junction of any part of the carriageway of any road with the carriageway of the road on which it is parked whether that junction is on the same side of the road as that on which the vehicle is parked or not.

(6) Paragraph (5)(c)(ii) shall be construed in accordance with the diagram in Schedule 23.

(7) The classes of vehicle referred to in paragraph (5) are—

- (a) a motor vehicle being a goods vehicle the unladen weight of which does not exceed 1525 kg;
- (b) a passenger vehicle other than a bus;
- (c) an invalid carriage; and
- (d) a motor cycle or a cycle in either case with or without a sidecar, not being—
 - (i) a vehicle to which a trailer is attached;
 - (ii) a vehicle which is required to be fitted with lamps by regulation 24; or
 - (iii) a vehicle carrying a load, if the load is required to be fitted with lamps by regulation 24.

(8) The circumstances referred to in paragraph (5)(c)(i) are that—

- (a) the vehicle is parked on a road on which the driving of vehicles otherwise than in one direction is prohibited at all times and its left or near side is as close as may be and parallel to the left-hand edge of the carriageway or its right or off side is as close as may be and parallel to the right-hand edge of the carriageway; or

(18) S.I. 1997/276 (N.I. 2)

(19) S.R. 1997 No. 386

- (b) the vehicle is parked on a road on which such a prohibition does not exist and its left or near side is as close as may be and parallel to the edge of the carriageway.
- (9) Paragraphs (1), (2), (3) and (4) do not apply in respect of—
 - (a) a solo motor bicycle or a cycle being pushed along the left-hand edge of a carriageway;
 - (b) a cycle waiting to proceed provided it is kept to the left-hand or near side edge of a carriageway; or
 - (c) a vehicle which is parked in an area on part of a highway on which roadworks are being carried out and which is bounded by amber lamps and other traffic signs so as to prevent the presence of the vehicle, its load or equipment being a danger to persons using the road.

Requirements about the use of headlamps and front fog lamps

28.—(1) Save as provided in paragraph (2), a person shall not use, or cause or permit to be used, on a road a vehicle which is fitted with obligatory dipped-beam headlamps unless every such lamp is kept lit—

- (a) during the hours of darkness; and
- (b) in seriously reduced visibility.
- (2) The provisions of paragraph (1) do not apply—
 - (a) in the case of a motor vehicle fitted with one obligatory dipped-beam headlamp or a solo motor bicycle or motor bicycle combination fitted with a pair of obligatory dipped-beam headlamps, if a main-beam headlamp or a front fog lamp is kept lit;
 - (b) in the case of a motor vehicle, other than a solo motor bicycle or motor bicycle combination, fitted with a pair of obligatory dipped-beam headlamps, if—
 - (i) a pair of main-beam headlamps is kept lit; or
 - (ii) in seriously reduced visibility, a pair of front fog lamps which is so fitted that the outermost part of the illuminated area of each lamp in the air is not more than 400 mm from the outer edge of each vehicle is kept lit;
 - (c) to a vehicle being drawn by another vehicle;
 - (d) to a vehicle while being used to propel a snow plough; or
 - (e) to a vehicle which is parked.

(3) For the purposes of this regulation a headlamp shall not be regarded as lit if its intensity is reduced by a dim-dip device.

Requirements about the use of warning beacons

29. A person shall not use, or cause or permit to be used, on an unrestricted dual-carriageway road a vehicle which is required to be fitted with at least one warning beacon by regulation 20 unless every such beacon is kept lit.

Restrictions on the use of lamps other than those to which regulation 27 refers

30. A person shall not use, or cause or permit to be used, on a road any vehicle on which any lamp, hazard warning signal device or warning beacon of a type specified in an item in column 2 of the Table is used in a manner specified in that item in column 3.

TABLE

(1) <i>Item</i>	(2) <i>Type of lamp, hazard warning signal device or warning beacon</i>	(3) <i>Manner of use prohibited</i>
1	Headlamp	(a) (a) Used so as to cause undue dazzle or discomfort to other persons using the road. (b) Used so as to be lit when a vehicle is parked.
2.	Front fog lamp	(a) (a) Used so as to cause undue dazzle or discomfort to other persons using the road. (b) Used so as to be lit at any time other than in conditions of seriously reduced visibility. (c) Used so as to be lit when a vehicle is parked.
3.	Rear fog lamp	(a) (a) Used so as to cause undue dazzle or discomfort to the driver of a following vehicle. (b) Used so as to be lit at any time other than in conditions of seriously reduced visibility. (c) Save in the case of an emergency vehicle, used so as to be lit when a vehicle is parked.
4.	Reversing lamp	Used so as to be lit except for the purpose of reversing the vehicle.
5.	Hazard warning signal device	Used other than— (i) to warn persons using the road of a temporary

Status: This is the original version (as it was originally made). This item of legislation is currently only available in its original format.

(1) <i>Item</i>	(2) <i>Type of lamp, hazard warning signal device or warning beacon</i>	(3) <i>Manner of use prohibited</i>
6.	Warning beacon emitting blue light and special warning lamp	obstruction when the vehicle is at rest; or (ii) on a motorway or unrestricted dual-carriageway, to warn following drivers of a need to slow down due to a temporary obstruction ahead; or (iii) in the case of a bus, to summon assistance for the driver or any person acting as a conductor or inspector on the vehicle; or (iv) in the case of a bus to which prescribed signs are fitted as described in sub-paragraphs (a) and (b) of regulation 17(1) and in the case of a bus painted in the livery of an Education and Library Board as referred to in sub-paragraph (b) of paragraph (2) of that regulation when the bus is stationary and children under the age of 16 years are entering or leaving, or are about to enter or leave, or have just left the vehicle. Used so as to be lit except— or

Status: This is the original version (as it was originally made). This item of legislation is currently only available in its original format.

(1) Item	(2) Type of lamp, hazard warning signal device or warning beacon	(3) Manner of use prohibited
		<ul style="list-style-type: none"> (i) at the scene of an emergency; (ii) when it is necessary or desirable either to indicate to persons using the road the urgency of the purpose for which the vehicle is being used, or to warn persons of the presence of the vehicle or a hazard on the road.
7.	Warning beacon emitting amber light	Used so as to be lit except— <ul style="list-style-type: none"> (i) at the scene of an emergency; (ii) when it is necessary or desirable to warn persons of the presence of the vehicle; and (iii) in the case of a breakdown vehicle, while it is being used in connection with, and in the immediate vicinity of, an accident or breakdown, or while it is being used to draw a broken-down vehicle.
8.	Warning beacon emitting green light	Used so as to be lit except whilst occupied by a medical practitioner registered by the General Medical Council (whether with full, provisional or limited registration) and used for the purposes of an emergency.
9.	Warning beacon emitting yellow light	Used so as to be lit on a road.
10.	Work lamp	(a) (a) Used so as to cause undue dazzle

Status: This is the original version (as it was originally made). This item of legislation is currently only available in its original format.

(1) <i>Item</i>	(2) <i>Type of lamp, hazard warning signal device or warning beacon</i>	(3) <i>Manner of use prohibited</i>
		or discomfort to the driver of any vehicle. (b) Used so as to be lit except for the purpose of illuminating a working area, accident, breakdown or works in the vicinity of the vehicle.
11.	Any other lamp	Used so as to cause undue dazzle or discomfort to other persons using the road.

Revocation

31. The regulations specified in Schedule 26 are hereby revoked.

Sealed with the Official Seal of the Department of the Environment on 12th May 2000.

L.S.

J. Ritchie
A senior officer of the
Department of the Environment

SCHEDULE 1

Regulation 21

Obligatory lamps, reflectors, rear markings and devices

TABLE I**Motor vehicle having three or more wheels not being a vehicle to which any other Table in this Schedule applies**

(1) <i>Type of lamp, reflector, rear marking or device</i>	(2) <i>Schedule in which relevant installation and performance requirements are specified</i>	(3) <i>Exceptions</i>
Front position lamp	Schedule 2: Part I	None.
Dim-dip device or running lamp	Schedule 3: Part I	<p>A vehicle having a maximum speed not exceeding 40 mph;</p> <p>A vehicle first used before 24th January 1996;</p> <p>A home forces' vehicle;</p> <p>A vehicle in respect of which the following conditions are satisfied—</p> <p>(a) there is fitted to the vehicle all the lighting and light-signalling devices listed in items 1.5.7 to 1.5.20 of Annex I of Community Directive 76/756/EEC, as last amended by Directive 89/278/EEC or Community Directive 76/756/EEC as last amended by Directive 91/663/EEC, which are required to be fitted under that Annex; and</p> <p>(b) all those devices are so installed that they comply with the requirements set out in items 3 and 4 of that Annex including, in particular, item</p>

Status: This is the original version (as it was originally made). This item of legislation is currently only available in its original format.

(1) <i>Type of lamp, reflector, rear marking or device</i>	(2) <i>Schedule in which relevant installation and performance requirements are specified</i>	(3) <i>Exceptions</i>
Dipped-beam headlamp	Schedule 4: Part I	4.2.6 (Alignment of dipped-beam headlamps). A vehicle having a maximum speed not exceeding 15 mph; A vehicle first used before 24th January 1996 being an agricultural vehicle or a works truck; A vehicle first used before 1st January 1931.
Main-beam headlamp	Schedule 5: Part I	A vehicle having a maximum speed not exceeding 25 mph; A vehicle first used before 24th January 1996 being an agricultural vehicle or a works truck; A vehicle first used before 1st January 1931.
Direction indicator	Schedule 7: Part I	An invalid carriage having a maximum speed not exceeding 4 mph and any other vehicle having a maximum speed not exceeding 15 mph; An agricultural vehicle having an unladen weight not exceeding 255 kg; A vehicle first used before 24th January 1996 being an agricultural vehicle, an industrial tractor or a works truck; A vehicle first used before 1st January 1936.
Hazard warning signal device	Schedule 8: Part I	A vehicle not required to be fitted with direction indicators; A vehicle first used before 24th January 1996.
Side marker lamp	Schedule 9: Part I	A vehicle having a maximum speed not exceeding 25 mph;

Status: This is the original version (as it was originally made). This item of legislation is currently only available in its original format.

(1) <i>Type of lamp, reflector, rear marking or device</i>	(2) <i>Schedule in which relevant installation and performance requirements are specified</i>	(3) <i>Exceptions</i>
Rear position lamp	Schedule 10: Part I	<p>A passenger vehicle; An incomplete vehicle proceeding to a works for completion or to a place where it is to be stored or displayed for sale; A vehicle the overall length of which does not exceed 6 m; A vehicle first used before 1st January 1997; A vehicle in respect of which the following conditions are satisfied—</p> <p>(a) there is fitted to the vehicle all the lighting and light-signalling devices listed in items 1.5.7 to 1.5.20 of Annex I of Community Directive 76/756/EEC, as last amended by Directive 89/278/EEC or Community Directive 76/756/EEC as last amended by Directive 91/663/EEC, which are required to be fitted under that Annex; and</p> <p>(b) all those devices are so installed that they comply with the requirements set out in items 3 and 4 of that Annex including, in particular, item 4.2.6 (Alignment of dipped-beam headlamps).</p>

Status: This is the original version (as it was originally made). This item of legislation is currently only available in its original format.

(1) <i>Type of lamp, reflector, rear marking or device</i>	(2) <i>Schedule in which relevant installation and performance requirements are specified</i>	(3) <i>Exceptions</i>
Rear fog lamp	Schedule 11: Part I	A vehicle having a maximum speed not exceeding 25 mph; A vehicle first used before 24th January 1996 being an agricultural vehicle or a works truck; A vehicle manufactured before 1st May 1980 and first used before 1st November 1980; A vehicle having an overall width which does not exceed 1300 mm.
Stop lamp	Schedule 12: Part I	A vehicle having a maximum speed not exceeding 25 mph; A vehicle first used before 24th January 1996 being an agricultural vehicle or a works truck; A vehicle first used before 1st January 1936.
End-outline marker lamp	Schedule 13: Part I	A vehicle having a maximum speed not exceeding 25 mph; A motor vehicle having an overall width not exceeding 2100 mm; An incomplete vehicle proceeding to a works for completion or to a place where it is to be stored or displayed for sale; A motor vehicle first used before 24th January 1996 .
Rear registration plate lamp	Schedule 15	A vehicle not required to be fitted with a rear registration plate; A works truck.
Side retro reflector	Schedule 17: Part I	A vehicle having a maximum speed not exceeding 25 mph; A goods vehicle—

Status: This is the original version (as it was originally made). This item of legislation is currently only available in its original format.

(1) <i>Type of lamp, reflector, rear marking or device</i>	(2) <i>Schedule in which relevant installation and performance requirements are specified</i>	(3) <i>Exceptions</i>
Rear retro reflector	Schedule 18: Part I	<p>(a) first used on or after 24th January 1996, the overall length of which does not exceed 6 m; or</p> <p>(b) first used before 24th January 1996, the overall length of which does not exceed 8 m;</p> <p>A passenger vehicle; An incomplete vehicle proceeding to a works for completion or to a place where it is to be stored or displayed for sale; A vehicle primarily constructed for moving excavated material and being used by virtue of an order under Article 60 of the 1995 Order; A mobile crane or engineering plant.</p>
Rear marking	Schedule 19: Part I	<p>None</p> <p>A vehicle having a maximum speed not exceeding 25 mph; A vehicle first used before 1st October 1983, the unladen weight of which does not exceed 3050 kg; A vehicle the maximum gross weight of which does not exceed 7500 kg; A passenger vehicle not being an articulated bus; A tractive unit for an articulated vehicle; An incomplete vehicle proceeding to a works for completion or to a place where it is to be stored or displayed for sale; A vehicle first used before 1st April 1986</p>

Status: This is the original version (as it was originally made). This item of legislation is currently only available in its original format.

(1) <i>Type of lamp, reflector, rear marking or device</i>	(2) <i>Schedule in which relevant installation and performance requirements are specified</i>	(3) <i>Exceptions</i>
		being an agricultural vehicle, a works truck or engineering plant; A vehicle first used before 1st January 1940; A home forces' vehicle; A vehicle constructed or adapted for— (a) fire fighting or fire salvage; (b) servicing or controlling aircraft; (c) heating and dispensing tar or other material for the construction or maintenance of roads; or (d) transporting two or more vehicles or vehicle bodies or two or more boats.

TABLE II

Solo motor bicycle and motor bicycle combination

(1) <i>Type of lamp, or reflector</i>	(2) <i>Schedule in which relevant installation and performance requirements are specified</i>	(3) <i>Exceptions</i>
Front position lamp	Schedule 2: Part I	A solo motor bicycle fitted with a headlamp.
Dipped-beam headlamp.	Schedule 4: Part I	A vehicle first registered before 1st January 1931.
Main-beam headlamp	Schedule 5: Part I	A vehicle having a maximum speed not exceeding 25 mph; A vehicle first used before 1st January 1972 and having an engine with a capacity of less than 50 cc; A vehicle first registered before 1st January 1931.

Status: This is the original version (as it was originally made). This item of legislation is currently only available in its original format.

(1) <i>Type of lamp, or reflector</i>	(2) <i>Schedule in which relevant installation and performance requirements are specified</i>	(3) <i>Exceptions</i>
Direction indicator	Schedule 7: Part I	A vehicle having a maximum speed not exceeding 25 mph; A vehicle first used before 24th January 1996; A vehicle which is constructed or adapted primarily for use off roads (whether by reason of its tyres, suspension, ground clearance or otherwise) and which can carry only one person or which, in the case of a motor bicycle combination, can carry only the rider and one passenger in the sidecar.
Rear position lamp	Schedule 10: Part I	None.
Stop lamp	Schedule 12: Part I	A vehicle having a maximum speed not exceeding 25 mph; A vehicle first used before 24th January 1996 and having an engine with a capacity of less than 50 cc; A vehicle first used before 1st January 1936.
Rear registration plate lamp	Schedule 15	A vehicle not required to be fitted with a rear registration plate.
Rear retro reflector	Schedule 18: Part I	None.

TABLE III

Cycle

(1) <i>Type of lamp or reflector</i>	(2) <i>Schedule in which relevant installation and performance requirements are specified</i>	(3) <i>Exceptions</i>
Front position lamp	Schedule 2: Part I	None.
Rear position lamp	Schedule 10: Part I	None.

Status: This is the original version (as it was originally made). This item of legislation is currently only available in its original format.

(1) <i>Type of lamp or reflector</i>	(2) <i>Schedule in which relevant installation and performance requirements are specified</i>	(3) <i>Exceptions</i>
Rear retro reflector	Schedule 18: Part I	None.
Pedal retro reflector	Schedule 20: Part I	A cycle manufactured before 24th January 1996.

TABLE IV

Pedestrian-controlled vehicle, horse-drawn vehicle and track-laying vehicle

(1) <i>Type of lamp or reflector</i>	(2) <i>Schedule in which relevant installation and performance requirements are specified</i>	(3) <i>Exceptions</i>
Front position lamp	Schedule 2: Part I	None.
Rear position lamp	Schedule 10: Part I	None.
Rear retro reflector	Schedule 18: Part I	None.

TABLE V

Vehicle drawn or propelled by hand

(1) <i>Type of lamp or reflector</i>	(2) <i>Schedule in which relevant installation and performance requirements are specified</i>	(3) <i>Exceptions</i>
Front position lamp	Schedule 2: Part I	None.
Rear position lamp	Schedule 10: Part I	A vehicle fitted with a rear retro reflector.
Rear retro reflector	Schedule 18: Part I	A vehicle fitted with a rear position lamp.

TABLE VI

Trailer drawn by a motor vehicle

(1) <i>Type of lamp, reflector or rear marking</i>	(2) <i>Schedule in which relevant installation and performance requirements are specified</i>	(3) <i>Exceptions</i>
Front position lamp	Schedule 2: Part I	A trailer with an overall width not exceeding 1600 mm; A trailer manufactured before 24th January 1996 the overall length of

Status: This is the original version (as it was originally made). This item of legislation is currently only available in its original format.

(1) <i>Type of lamp, reflector or rear marking</i>	(2) <i>Schedule in which relevant installation and performance requirements are specified</i>	(3) <i>Exceptions</i>
Direction indicator	Schedule 7: Part I September 1965;	<p>which, excluding any drawbar and any fitting for its attachment, does not exceed 2300 mm; A trailer constructed or adapted for the carriage and launching of a boat.</p> <p>A trailer manufactured before 1st An agricultural vehicle or a works trailer in either case manufactured before 24th January 1996 .</p>
Side marker lamp	Schedule 9: Part I	<p>A trailer the overall length of which, excluding any drawbar and any fitting for its attachment, does not exceed—</p> <p>(a) 6 m, (b) 9.15 m in the case of a trailer manufactured before 24th January 1996;</p> <p>An incomplete trailer proceeding to a works for completion or to a place where it is to be stored or displayed for sale; An agricultural vehicle or a works trailer; A caravan; A trailer constructed or adapted for the carriage and launching of a boat; A trailer in respect of which the following conditions are satisfied—</p> <p>(a) there is fitted to the trailer all the lighting and lighting-signalling devices listed in items 1.5.7 to 1.5.20 of Annex I of Community Directive 76/756/</p>

Status: This is the original version (as it was originally made). This item of legislation is currently only available in its original format.

(1) <i>Type of lamp, reflector or rear marking</i>	(2) <i>Schedule in which relevant installation and performance requirements are specified</i>	(3) <i>Exceptions</i>
		<p>EEC, as last amended by Directive 89/278/EEC or Community Directive 76/756/EEC as last amended by Directive 91/663/EEC, which are required to be fitted under that Annex; and</p> <p>(b) all those devices are so installed and maintained that they comply with the requirements set out in items 3 and 4 of that Annex.</p>
Rear position lamp	Schedule 10: Part I	None.
Rear fog lamp	Schedule 11: Part I	<p>A trailer manufactured before 1st May 1980;</p> <p>A trailer the overall width of which does not exceed 1300 mm;</p> <p>An agricultural vehicle or a works trailer.</p>
Stop lamp	Schedule 12: Part I	An agricultural vehicle or a works trailer.
End-outline marker lamp	Schedule 13: Part I	<p>A trailer having an overall width not exceeding 2100 mm;</p> <p>An incomplete trailer proceeding to a works for completion or to a place where it is to be stored or displayed for sale;</p> <p>An agricultural vehicle or a works trailer;</p> <p>A trailer manufactured before 24th January 1996.</p>
Rear registration plate lamp	Schedule 15	A trailer not required to be fitted with a rear registration plate.

Status: This is the original version (as it was originally made). This item of legislation is currently only available in its original format.

(1) <i>Type of lamp, reflector or rear marking</i>	(2) <i>Schedule in which relevant installation and performance requirements are specified</i>	(3) <i>Exceptions</i>
Side retro reflector	Schedule 17: Part I excluding any drawbar, does not exceed 5 m;	A trailer the overall length of which, An incomplete trailer proceeding to a works for completion or to a place where it is to be stored or displayed for sale; Engineering plant; A trailer primarily constructed for moving excavated material and which is being used by virtue of an Order under Article 60 of the 1995 Order.
Front retro reflector	Schedule 21: Part I January 1996;	A trailer manufactured before 24th An agricultural vehicle or a works trailer.
Rear retro reflector	Schedule 18: Part I	None.
Rear marking	Schedule 19: Part I	A trailer first used before 1st July 1983, the unladen weight of which does not exceed 1020 kg; A trailer the maximum gross weight of which does not exceed 3500 kg; An incomplete trailer proceeding to a works for completion or to a place where it is to be stored or displayed for sale; An agricultural vehicle, a works trailer or engineering plant; A trailer drawn by a bus; A home forces' vehicle; A trailer constructed or adapted for— (a) fire fighting or salvage; (b) servicing or controlling aircraft; (c) heating and dispensing tar or other material for the construction

Status: This is the original version (as it was originally made). This item of legislation is currently only available in its original format.

(1) <i>Type of lamp, reflector or rear marking</i>	(2) <i>Schedule in which relevant installation and performance requirements are specified</i>	(3) <i>Exceptions</i>
		or maintenance of roads; (d) carrying asphalt or macadam, in each case being mixing or drying plant; (e) transporting two or more vehicles or vehicle bodies or two or more boats; (f) a works trailer; or (g) a trailer drawn by a public service vehicle.

TABLE VII

Trailer drawn by a cycle

(1) <i>Type of lamp, reflector or rear marking</i>	(2) <i>Schedule in which relevant installation and performance requirements are specified</i>	(3) <i>Exceptions</i>
Rear position lamp	Schedule 10: Part I	None.
Rear retro reflector	Schedule 18: Part I	None.

SCHEDULE 2

Regulations 21 and 23

Part I

Requirements relating to Obligatory Front Position Lamps and to Optional Front Position Lamps to the Extent Specified in Part II

1. Number—

- (a) Any vehicle not covered by sub-paragraph (b), (c), (d), (e) or (f): Two
- (b) A cycle with less than four wheels and without a sidecar: One
- (c) A solo motor bicycle: One
- (d) A motor bicycle combination with a headlamp on the motor bicycle: One, on the sidecar

- (e) An invalid carriage: One
- (f) A vehicle drawn or propelled by hand: One
- 2. Position—
 - (a) Longitudinal: No requirement
 - (b) Lateral—
 - (i) (i) Where two front position lamps are required to be fitted—
 - (A) Maximum distance from the side of the vehicle—
 - (1) A motor vehicle first used on or after 24th January 1996: 400 mm
 - (2) A trailer manufactured on or after 24th January 1996: 150 mm
 - (3) Any other vehicle manufactured on or after 24th January 1996: 400 mm
 - (4) A motor vehicle first used before 24th January 1996 and any other vehicle manufactured before 24th January 1996: 300 mm
 - (B) Minimum separation distance between front position lamps: No requirement
 - (ii) (ii) Where one front position lamp is required to be fitted—
 - (A) A sidecar forming part of a motor bicycle combination: On the centre-line of the side- car or on the side of the side- car furthest from the motor bicycle
 - (B) Any other vehicle: On the centre-line or offside of the vehicle
 - (c) Vertical—
 - (i) (i) Maximum height above the ground—
 - (A) Any vehicle not covered by sub-head (B) or (C): 1500 mm or, if the structure of the vehicle makes this impractical, 2100 mm
 - (B) A motor vehicle, first used on or after 24th January 1996, having a maximum speed not exceeding 25 mph: 2100 mm
 - (C) A bus and a road clearance vehicle: No requirement
 - (ii) (ii) Minimum height above the ground: No requirement
 - 3. Angles of visibility—
 - (a) A motor vehicle (not being a motor bicycle combination or an agricultural vehicle) first used on or after 24th January 1996 and a

Status: This is the original version (as it was originally made). This item of legislation is currently only available in its original format.

trailer manufactured on or after 24th January 1996 —

(i) (i) Horizontal—

- (A) Where one lamp is required to be fitted: 80° to the left and to the right
 (B) Where two lamps are required to be fitted: 80° outwards and 45° inwards (5° inwards in the case of a trailer)

(ii) (ii) Vertical—

- (A) Any case not covered by sub-head (B): 15° above and below the horizontal
 (B) Where the highest part of the illuminated area of the lamp is less than 750 mm above the ground: 15° above and 5° below the horizontal

(b) Any other vehicle: Visible to the front

4. Alignment: To the front

5. Markings (see also regulation 2(5))—

(a) A motor vehicle (other than a solo motor bicycle or a motor bicycle combination) first used on or after 24th January 1996 and a trailer manufactured on or after 24th January 1996: An approval mark

(b) A solo motor bicycle and a motor bicycle combination in either case first used on or after 24th January 1996: An approval mark

(c) Any other vehicle manufactured on or after 24th January 1996: An approval mark or the British Standard mark which is specified in sub-paragraph (b) of the definition of “British Standard Mark” in paragraph 13.

(d) Any other vehicle: No requirement

6. Size of illuminated area: No requirement

7. Colour: White or, if incorporated in a headlamp which is capable of emitting only a yellow light, yellow.

8. Wattage: No requirement

9. Intensity—

(a) A front position lamp bearing any of the markings mentioned in paragraph 5: No requirement

(b) Any other front position lamp: Visible from a reasonable distance

10. Electrical connections: No individual requirement

11. Tell-tale: No requirement

12. Other requirements—

- (a) except in the case of a vehicle covered by sub-paragraph (b), where two front position lamps are required to be fitted they shall form a pair, and

Status: This is the original version (as it was originally made). This item of legislation is currently only available in its original format.

- (b) in the case of a trailer manufactured before 24th January 1996 and a motor bicycle combination, where two front position lamps are required to be fitted they shall be fitted on each side of the longitudinal axis of the vehicle.

13. Definitions—

In this Schedule—

“approval mark” means—

- (a) in relation to a solo motor bicycle or a motor bicycle combination, a marking designated as an approval mark by regulation 4 of the Designation of Approval Marks Regulations and shown at item 50A of Schedule 2 to those Regulations, and
- (b) in relation to any other vehicle, either—
 - (i) a marking designated as an approval mark by regulation 5 of the Designation of Approval Marks Regulations and shown at item 5 of Schedule 4 to those Regulations, or
 - (ii) a marking designated as an approval mark by regulation 4 of the Designation of Approval Marks Regulations and shown at item 7 of Schedule 2 to those Regulations;

“British Standard mark” means—

- (a) the mark indicated in the specification for photometric and physical requirements for lighting equipment published by the British Standards Institution under the reference BS 6102: Part 3: 1986 namely “6102/3”; or
- (b) the mark indicated in the specification for photometric and physical requirements for lighting equipment published by the British Standards Institution under the reference BS 6102: Part 3: 1986 as amended by AMD 5821 published on the 29th April 1988, namely “6102/3”.

Part II

Requirements Relating to Optional Front Position Lamps

1. In the case of a solo motor bicycle first used on or after 24th January 1996 which is not fitted with any obligatory front position lamp, not more than two may be fitted which must comply with the requirement specified in paragraph 7 of Part I. Where two are fitted these shall be situated as close together as possible.

2. In the case of a solo motor bicycle first used on or after 24th January 1996 which is fitted with one obligatory front position lamp, not more than one additional lamp may be fitted which must comply with the requirement specified in paragraph 7 of Part I and shall be situated as close as possible to the obligatory front position lamp.

3. In the case of any other vehicle the only requirement prescribed by these Regulations in respect of any which are fitted is that in paragraph 7 of Part I.

Status: This is the original version (as it was originally made). This item of legislation is currently only available in its original format.

SCHEDULE 3

Regulations 21 and 23

Part I

Requirements Relating to Obligatory Dim-Dip Devices and Running Lamps

1. A dim-dip device fitted to satisfy regulation 21 shall cause light to be emitted from the dipped-beam filament of each obligatory dipped-beam headlamp, each such light having, so far as is practicable, an intensity of between 10 and 20 per cent. of the intensity of the normal dipped beam.
2. Running lamps fitted to satisfy regulation 21 shall be in the form of a matched pair of front lamps each of which—
 - (a) is fitted in a position in which an obligatory front position lamp may lawfully be fitted, and
 - (b) is capable of emitting white light to the front having an intensity of not less than 200 candelas, measured from directly in front of the centre of the lamp in a direction parallel to the longitudinal axis of the vehicle, and of not more than 800 candelas in any direction.
3. The electrical connections to the obligatory dim-dip device shall be such that the light output specified in paragraph 1 is automatically emitted whenever the following four conditions are satisfied, namely—
 - (a) the engine is running, or the key or devices which control the starting or stopping of the engine are in the normal position for when the vehicle is being driven;
 - (b) the obligatory main beam and dipped beam headlamps are switched off;
 - (c) any front fog lamp fitted to the vehicle is switched off; and
 - (d) the obligatory front position lamps are switched on.
4. The electrical connections to the obligatory running lamps shall be such that the light output specified in paragraph 2 above is automatically emitted, whenever the conditions set out in subparagraphs (a), (b) and (c) of paragraph 3 are satisfied.

Part II

Requirements relating to Optional Dim-Dip Devices and Running Lamps

There is no requirement relating to an optional dim-dip device or an optional running lamp.

SCHEDULE 4

Regulations 21 and 23

Part I

Requirements Relating to Obligatory Dipped-Beam Headlamps and to Optional Dipped-Beam Headlamps to the Extent Specified in Part II

-
1. Number—
 - (a) Any vehicle not covered by sub-paragraph (b), (c), (d) or (e):

(b) A solo motor bicycle and a motor bicycle One combination:

(c) A motor vehicle with three wheels, other One than a motor bicycle combination, first used before 24th January 1996:

(d) A motor vehicle with three wheels, other One than a motor bicycle combination, first used on or after 24th January 1996 and which has an unladen weight of not more than 400 kg and an overall width of not more than 1300 mm:

(e) A bus first used before 1st October 1969: One

2. Position—

(a) Longitudinal: No requirement

(b) Lateral—

(i) (i) Where two dipped-beam headlamps are required to be fitted—

(A) Maximum distance from the side of the vehicle—

(1) Any vehicle not covered by sub-head 400 mm (2) or (3):

(2) A vehicle first used before 1st January 1972: No requirement

(3) An agricultural vehicle, engineering plant and an industrial tractor: No requirement

(B) Minimum separation distance between a pair of dipped-beam headlamps: No requirement

(ii) (ii) Where one dipped-beam headlamp is required to be fitted—

(A) Any vehicle not covered by sub-head (B): (i) On the centre-line of the motor vehicle (disregarding any sidecar forming part of a motor bicycle combination), or (ii) At any distance from the side of the motor vehicle (disregarding any sidecar forming part of a motor bicycle combination) provided that a duplicate lamp is fitted on the other side so that together they form a matched pair. In such a case, both lamps shall be regarded as obligatory lamps.

(B) A bus first used before 1st October 1969: No requirement

(c) Vertical—

(i) (i) Maximum height above the ground—

Status: This is the original version (as it was originally made). This item of legislation is currently only available in its original format.

- (A) Any vehicle not covered by sub- head (B): 1200 mm
- (B) A vehicle first used before 1st January 1952, an agricultural vehicle, a road clearance vehicle, an aerodrome fire tender, an aerodrome runway sweeper, an industrial tractor, engineering plant and a home forces' vehicle:
 - (ii) (ii) Minimum height above the ground—
- (A) Any vehicle not covered by sub- head (B): 500 mm
- (B) A vehicle first used before 1st January 1956: No requirement
- 3. Angles of visibility: No requirement
- 4. Alignment—

When a vehicle is at its kerbside weight and has a weight of 75 kg on the driver's seat, and any manual headlamp levelling device control is set to the stop position, the alignment of every dipped-beam headlamp shall, as near as practicable, be set so that it is permanently deflected downwards to such an extent that it is at all times incapable of dazzling any person at a greater distance than 9 m from the lamp whose eye-level is not less than 1300 mm above that plane.

5. Markings—

- (a) Any vehicle not covered by sub- paragraph (b), (c) or (d): An approval mark or a British Standard mark
- (b) A motor vehicle first used before 24th January 1996: No requirement
- (c) A three-wheeled motor vehicle, not being a motor bicycle combination, first used on or after 24th January 1996 and having a maximum speed not exceeding 50 mph: No requirement
- (d) A solo motor bicycle and a motor bicycle combination: No requirement
- 6. Size of illuminated area: No requirement
- 7. Colour: White or yellow
- 8. Wattage—
 - (a) A motor vehicle with four or more wheels first used on or after 24th January 1996: No requirement
 - (b) A three-wheeled motor vehicle, not being a motor bicycle combination, first used on or after 24th January 1996—
 - (i) (i) having a maximum speed not exceeding 15 watts minimum 50 mph:

- (ii) (ii) having a maximum speed No requirement 50 mph:
exceeding
- (c) A motor vehicle with four or more wheels 30 watts minimum
first used before 24th January 1996:
- (d) A three-wheeled motor vehicle, not being No requirement
a motor bicycle combination, first used before
24th January 1996:
- (e) A solo motor bicycle and a motor bicycle
combination, first used on or after 24th January
1996—
 - (i) (i) having an engine not exceeding 10 watts minimum
250 cc and a maximum speed not
exceeding 25 mph:
 - (ii) (ii) having an engine not exceeding 15 watts minimum
250 cc and a maximum speed
exceeding 25 mph:
 - (iii) (iii) having an engine exceeding 24 watts minimum
250 cc:
- 9. Intensity: No requirement
- 10. Electrical connections—

Where a matched pair of dipped-beam
headlamps is fitted they shall be capable of
being switched on and off simultaneously and
not otherwise.
- 11. Tell-tale: No requirement

- 12. Other requirements—
 - (a) every dipped-beam headlamp shall be so constructed that the direction of the beam of light
emitted therefrom can be adjusted whilst the vehicle is stationary.
 - (b) every vehicle which—
 - (i) is fitted with dipped-beam headlamps bearing an approval mark,
 - (ii) has a maximum speed exceeding 25 mph, and
 - (iii) is first used on or after 24th January 1996,shall be marked with a clearly legible and indelible marking, as illustrated in Schedule 24,
close to either the headlamps or the manufacturer’s plate showing the setting recommended
by the manufacturer for the downward inclination of the horizontal part of the cut-off of
the beam pattern of the dipped-beam headlamps when the vehicle is at its kerbside weight
and has a weight of 75 kg on the driver’s seat. That setting shall be a single figure—
 - (A) between 1 and 1.5 per cent. if the height of the centre of the headlamp is not more than
850 mm above the ground, and
 - (B) between 1 and 2 per cent. if the height of the centre of the headlamp is more than 850
mm above the ground.

Status: This is the original version (as it was originally made). This item of legislation is currently only available in its original format.

- (c) Every dipped-beam headlamp fitted to a vehicle first used on or after 24th January 1996 in accordance with this part of this Schedule shall be designed for a vehicle which is intended to be driven on the left-hand side of the road.
- (d) Where two dipped-beam headlamps are required to be fitted they shall form a matched pair.

13. Definitions—

In this Schedule—

“approval mark” means either—

- (a) a marking designated as an approval mark by regulation 5 of the Designation of Approval Marks Regulations and shown at item 12 or 13 or 14 or 16 or, in the case of a vehicle having a maximum speed not exceeding 25 mph, 27 or 28 of Schedule 4 to those Regulations, or
- (b) a marking designated as an approval mark by regulation 4 of the Designation of Approval Marks Regulations and shown at item 1A or 1B or 1C or 1E or 5A or 5B or 5C or 5E or 8C or 8D or 8E or 8F or 8G or 8H or 8K or 8L or 20C or 20D or 20E or 20F or 20G or 20H or 20K or 20 L or 31A or 31C or, in the case of a vehicle having a maximum speed not exceeding 25 mph, 1H or 1I or 5H or 5I of Schedule 2 to those Regulations; and

“British Standard mark” means the specification for sealed beam headlamps published by the British Standards Institution under the reference BS AU 40: Part 4a: 1966 as amended by Amendment AMD 2188 published in December 1976, namely “B.S. AU40.”

Part II

Requirements Relating to Optional Dipped-Beam Headlamps

1. In the case of a vehicle with three or more wheels having a maximum speed exceeding 25 mph first used on or after 24th January 1996, two and not more than two may be fitted and the only requirements prescribed by these Regulations in respect of any which are fitted are—
 - (a) those specified in paragraphs 2(c), 4, 7, 10 and 12(a) of Part I,
 - (b) that they are designed for a vehicle which is intended to be driven on the right-hand side of the road,
 - (c) that they form a matched pair, and
 - (d) that their electrical connections are such that not more than one pair of dipped-beam headlamps is capable of being illuminated at a time.
2. In the case of any other vehicle, any number may be fitted and the only requirements prescribed by these Regulations in respect of any which are fitted are those specified in paragraphs 2(c), 4, 7 and 12(a) of Part I.

SCHEDULE 5

Regulations 21 and 23

Part I

Requirements Relating to Obligatory Main-Beam Headlamps and to Optional Main-Beam Headlamps to the Extent Specified in Part II

1. Number—

(a) Any vehicle not covered by sub-paragraph (b), (c) or (d):

(b) A solo motor bicycle and a motor bicycle combination:

(c) A motor vehicle with three wheels, other than a motor bicycle combination, first used before 24th January 1996:

(d) A motor vehicle with three wheels, other than a motor bicycle combination, first used on or after 24th January 1996 and which has an unladen weight of not more than 400 kg and an overall width of not more than 1300 mm:

2. Position—

(a) Longitudinal: No requirement

(b) Lateral—

(i) (i) Where two main-beam headlamps are required to be fitted—

(A) Maximum distance from the side of the vehicle: The outer edges of the illuminated areas must in no case be closer to the side of the vehicle than the outer edges of the illuminated areas of the obligatory dipped-beam headlamps

(B) Maximum separation distance between a pair of main-beam headlamps: No requirement

(ii) (ii) Where one main-beam headlamp is required to be fitted:

(i) (i) On the centre-line of the motor vehicle (disregarding any sidecar forming part of a motor bicycle combination), or (

(ii) (ii) At any distance from the side of the vehicle (disregarding any sidecar forming part of a motor bicycle combination) provided that a duplicate lamp is fitted on the other side so that together they form a matched pair. In such a case, both lamps shall be treated as obligatory lamps

(c) Vertical: No requirement

Status: This is the original version (as it was originally made). This item of legislation is currently only available in its original format.

3. Angles of visibility: No requirement
4. Alignment: To the front
5. Markings—
- (a) Any vehicle not covered by sub-paragraph (b) or (c): An approval mark or a British Standard mark
- (b) A motor vehicle first used before 24th January 1996: No requirement
- (c) A solo motor bicycle and a motor bicycle combination: No requirement
6. Size of illuminated area: No requirement
7. Colour: White or yellow
8. Wattage—
- (a) A motor vehicle, other than a solo motor bicycle or motor bicycle combination, first used on or after 24th January 1996: No requirement
- (b) A motor vehicle, other than a solo motor bicycle or a motor bicycle combination, first used before 24th January 1996: 30 watts minimum
- (c) A solo motor bicycle and a motor bicycle combination—
- (i) (i) having an engine not exceeding 250 cc: 15 watts minimum
- (ii) (ii) having an engine exceeding 250 cc: 30 watts minimum
9. Intensity: No requirement
10. Electrical connections—
- (a) Every main-beam headlamp shall be so constructed that the light—
- (i) can be deflected at the will of the driver to become a dipped beam, or
- (ii) can be extinguished by the operation of a device which at the same time either—
- (A) causes the lamp to emit a dipped beam, or
- (B) causes another lamp to emit a dipped beam;
- (b) Where a matched pair of main-beam headlamps is fitted they shall be capable of being switched on and off simultaneously and not otherwise.
11. Tell-tale—
- (a) A motor vehicle first used on or after 24th January 1996: A circuit-closed tell-tale shall be fitted
- (b) Any vehicle not covered by sub-paragraph (a): No requirement
-
12. Other requirements—

- (a) Every main-beam headlamp shall be so constructed that the direction of the beam of light emitted therefrom can be adjusted whilst the vehicle is stationary.
- (b) Except in the case of a bus first used before 1st October 1969, where two main-beam headlamps are required to be fitted they shall form a matched pair.

13. Definitions—

In this Schedule—

“approval mark” means—

- (a) a marking designated as an approval mark by regulation 5 of the Designation of Approval Marks Regulations and shown at item 12 or 13 or 17 of Schedule 4 to those Regulations; or
- (b) a marking designated as an approval mark by regulation 4 of the Designation of Approval Marks Regulations as shown at item 1A or 1B or 1F or 5A or 5B or 5F or 8C or 8D or 8E or 8F or 8M or 8N or 20C or 20D or 20E or 20F or 20M or 20N or 31A or 31D of Schedule 2 to those Regulations; and

“British Standard mark” means the specification for sealed beam headlamps published by the British Standards Institution under the reference BS AU 40: Part 4a: 1966 as amended by Amendment AMD 2188 published in December 1976, namely “B.S. AU40.”

Part II

Requirements Relating to Optional Main-Beam Headlamps

Any number may be fitted and the only requirements prescribed by these Regulations in respect of any which are fitted are those specified in paragraphs 7, 10 and 12(a) of Part I and, in the case of a motor vehicle first used on or after 24th January 1996, paragraph 5 of Part I.

SCHEDULE 6

Regulation 23

Requirements relating to optional front fog lamps

1. Number—

(a) Any vehicle not covered by sub-paragraph (b): No requirement

(b) A motor bicycle, other than a motor bicycle or motor bicycle combination, first used on or after 24th January 1996: Not more than two

2. Position—

(a) Longitudinal: No requirement

(b) Lateral—

- (i) (i) Where a pair of front fog lamps is used in conditions of seriously reduced visibility in place of the obligatory dipped beam headlamps — 400 mm

Status: This is the original version (as it was originally made). This item of legislation is currently only available in its original format.

Maximum distance from side of vehicle:

- | | | |
|---------------|--|--|
| (ii) | (ii) In all other cases: | No requirement |
| (c) Vertical— | | |
| (i) | (i) Maximum height above the ground— | |
| (A) | Any vehicle not covered by head (B): | 1200 mm |
| (B) | An agricultural vehicle, a road clearance vehicle, an aerodrome fire tender, an aerodrome runway sweeper, an industrial tractor, engineering plant and a home forces' vehicle: | No requirement |
| (ii) | (ii) Minimum height above the ground: | No requirement |
| 3. | Angles of visibility: | No requirement |
| 4. | Alignment: | To the front and so aimed that the upper edge of the beam is, as near as practicable, 3 per cent. below the horizontal when the vehicle is at its kerb- side weight and has a weight of 75 kg on the driver's seat |
| 5. Markings— | | |
| (a) | A vehicle first used on or after 24th January 1996: | An approval mark |
| (b) | Any other vehicle: | No requirement |
| 6. | Size of illuminated area: | No requirement |
| 7. | Colour: | White or yellow |
| 8. | Wattage: | No requirement |
| 9. | Intensity: | No requirement |
| 10. | Electrical connections: | No individual requirement |
| 11. | Tell-tale: | No requirement |
-

12. Other requirements—

Every front fog lamp shall be so constructed that the direction of the beam of light emitted therefrom can be adjusted whilst the vehicle is stationary.

13. Definitions—

In this Schedule “approval mark” means either—

- (a) a marking designated as an approval mark by regulation 5 of the Designation of Approval Marks Regulations and shown at item 19 of Schedule 4 to those Regulations; or
- (b) a marking designated as an approval mark by regulation 4 of the Designation of Approval Marks Regulations and shown at item 19 or 19A of Schedule 2 to those Regulations.

SCHEDULE 7

Regulations 21 and 23

Part I

Requirements Relating to Obligatory Direction Indicators and to Optional Direction Indicators to the Extent Specified in Part II

1. Number (on each side of a vehicle)—

- (a) (a) A motor vehicle with three or more wheels, not being a motor bicycle combination, first used on or after 24th January 1996: One front indicator (Category 1, 1a or 1b), one rear indicator (Category 2, 2a or 2b) and one side repeater indicator (Category 5) or, in the case of a motor vehicle having a maximum speed not exceeding 25 mph, one front indicator (Category 1, 1a or 1b) and one rear indicator (Category 2, 2a or 2b).
- (b) (b) A trailer manufactured on or after 24th January 1996 drawn by a motor vehicle: One rear indicator (Category 2, 2a or 2b) or, in the case of a trailer towed by a solo motor bicycle or a motor bicycle combination, one rear indicator (Category 12).
- (c) (c) A solo motor bicycle and a motor bicycle combination, in each case first used on or after 24th January 1996: One front indicator (Category 1, 1a, 1b or 11) and one rear indicator (Category 2, 2a, 2b or 12).
- (d) (d) A motor vehicle first used on or after 1st April 1936 and before 24th January 1996, a trailer manufactured on or after 1st January 1936 and before 24th January 1996, a pedal cycle with or without a sidecar or a trailer, a horse-drawn vehicle and a vehicle drawn or propelled by hand: Any arrangement of indicators so as to satisfy the requirements for angles of visibility in paragraph 3.
- (e) (e) A motor vehicle first used before 1st January 1936 and any trailer manufactured before that date: Any arrangement of indicators so as to make the intention of the driver clear to other road users.

2. Position—

- (a) (a) Longitudinal—
 - (i) A side repeater indicator which is required to be fitted in accordance with paragraph 1(a): Within 2600 mm of the front of the vehicle
 - (ii) Any other indicator: No requirement
- (b) (b) Lateral—
 - (i) Maximum distance from the side of the vehicle—
 - (A) Any vehicle not covered by sub- head (B): 400 mm

Status: This is the original version (as it was originally made). This item of legislation is currently only available in its original format.

- (B) A motor vehicle first used before 24th January 1996, a trailer manufactured before 24th January 1996, a solo motor bicycle, a cycle, a horse-drawn vehicle and a vehicle drawn or propelled by hand: No requirement
- (ii) Minimum separation distance between indicators on opposite sides of a vehicle—
 - (A) A motor vehicle (other than a solo motor bicycle or a motor bicycle combination or an invalid carriage having a maximum speed not exceeding 8 mph) first used on or after 24th January 1996, a trailer manufactured on or after 24th January 1996, a horse-drawn vehicle, a pedestrian-controlled vehicle and a vehicle drawn or propelled by hand: 500 mm or, if the overall width of the vehicle is less than 1400 mm, 400 mm
 - (B) A solo motor bicycle having an engine exceeding 50 cc and first used on or after 24th January 1996—
 - (1) Front indicators: 300 mm
 - (2) Rear indicators: 240 mm
 - (C) A solo motor bicycle having an engine not exceeding 50 cc and first used on or after 24th January 1996 and a pedal cycle—
 - (1) Front indicators: 240 mm
 - (2) Rear indicators: 180 mm
 - (D) A motor bicycle combination first used on or after 24th January 1996: 400 mm
 - (E) An invalid carriage having a maximum speed not exceeding 8 mph—
 - (1) Front indicators: 240 mm
 - (2) Rear indicators: 300 mm
 - (F) A motor vehicle first used before 24th January 1996 and a trailer manufactured before 24th January 1996: No requirement

- (iii) Minimum separation distance between a front indicator and any dipped-beam head-lamp or front fog lamp—
- | | |
|--|--|
| (A) Fitted to a motor vehicle, other than a solo motor bicycle or a motor bicycle combination, first used on or after 24th January 1996: | (a) in the case of a Category 1 indicator, 40 mm; |
| | (b) in the case of a Category 1a indicator, 20 mm; |
| | (c) in the case of a Category 1b indicator, no requirement |
| (B) Fitted to a solo motor bicycle or a motor bicycle combination in either case first used on or after 24th January 1996: | 100 mm |
| (C) Fitted to any other vehicle: | No requirement |
| (c) (c) Vertical— | |
- (i) Maximum height above the ground—
- | | |
|--|--|
| (A) Any vehicle not covered by sub- (B) or (C): | 1500 mm or, if the structure of the vehicle makes this impracticable, 2300 mm. |
| (B) A motor vehicle first used before 24th January 1996 and a trailer manufactured before 24th January 1996: | No requirement |
| (C) A motor vehicle having a maximum speed not exceeding 25 mph: | No requirement |
- (ii) Minimum height above the ground: 350 mm
3. Angles of visibility—
- (a) (a) A motor vehicle first used on or after 24th January 1996 and a trailer manufactured on or after 24th January 1996—
- (i) Horizontal (see diagrams in Part III of this Schedule)—
- | | |
|--|------------------------------|
| (A) A front or rear indicator fitted to a motor vehicle, other than a solo motor bicycle or a motor bicycle combination, having a maximum speed exceeding 25 mph and every rear indicator fitted to a trailer: | 80° outwards and 45° inwards |
| (B) A front or rear indicator fitted to a solo motor bicycle or a motor bicycle combination: | 80° outwards and 20° inwards |
| (C) A front or rear indicator fitted to a motor vehicle, other than a solo motor bicycle or a motor bicycle | 80° outwards and 3° inwards |

Status: This is the original version (as it was originally made). This item of legislation is currently only available in its original format.

combination, having a maximum speed not exceeding 25 mph:

- (D) A side repeater indicator fitted to a motor vehicle or a trailer: Between rearward angles of 5° outboard and 60° outboard or, in the case of a motor vehicle having a maximum speed not exceeding 25 mph where it is impracticable to comply with the 5° angle, this may be replaced by 10°.

(ii) Vertical—

- (A) Except as provided by sub-head (B) or (C): 15° above and below the horizontal
- (B) Where the highest part of the illuminated area of the lamp is less than 1900 mm above the ground and the vehicle is a motor vehicle having a maximum speed not exceeding 25 mph: 15° above and 10° below the horizontal
- (C) Where the highest part of the illuminated area of the lamp is less than 750 mm above the ground: 15° above and 5° below the horizontal
- (b) (b) A motor vehicle first used before 24th January 1996, a trailer manufactured before 24th January 1996, a pedal-cycle, a horse-drawn vehicle and a vehicle drawn or propelled by hand: Such that at least one (but not necessarily the same) indicator on each side is plainly visible to the rear in the case of a trailer and both to the front and rear in the case of any other vehicle

4. Alignment—

- (a) (a) A front indicator: To the front
- (b) (b) A rear indicator: To the rear
- (c) (c) A side repeater indicator (Category 5): As shown in the first sketch in Part III of this Schedule

5. Markings—

- (a) (a) A motor vehicle, other than a solo motor bicycle or a motor bicycle combination, first used on or after 24th January 1996 and a trailer, other than a trailer drawn by a solo motor bicycle or a motor bicycle combination, manufactured on or after 24th January 1996: An approval mark and, above such mark, the following numbers—
 (a) in the case of a front indicator “1”, “1a”, or “1b”;
 (b) in the case of a rear indicator, “2”, “2a” or “2b”;
 (c) in the case of a side repeater indicator, “5”.
- (b) (b) A solo motor bicycle and a motor bicycle combination in either case first used on or after 24th January 1996, a trailer, manufactured on or after 24th January 1996, drawn by such a solo motor bicycle or a motor bicycle combination, a pedal cycle, An approval mark and, above such mark, the following numbers—
 (a) in the case of a front indicator “1”, “1a”, “1b” or “11”;
 (b) in the case of a rear indicator, “2”, “2a”, “2b” or “12”;

- a horse-drawn vehicle and a vehicle drawn or propelled by hand: (c) in the case of a side repeater indicator, "5".
- (c) (c) A motor vehicle first used before 24th January 1996 and a trailer manufactured before 24th January 1996: No requirement
6. Size of illuminated area: No requirement
7. Colour—
- (a) (a) Any vehicle not covered by sub-paragraph (b): Amber
- (b) (b) An indicator fitted to a motor vehicle first registered before 1st October 1968 and any trailer drawn thereby—
- (i) if it shows only the front: White or amber
- (ii) if it shows only the rear: Red or amber
- (iii) if it shows both to the front and to the rear: Amber
8. Wattage—
- (a) (a) Any front or rear indicator which emits a flashing light and does not bear an approval mark: 15 to 36 watts
- (b) (b) Any other indicator: No requirement
9. Intensity—
- (a) (a) An indicator bearing an approval mark: No requirement
- (b) (b) An indicator not bearing an approval mark: Such that the light is plainly visible from a reasonable distance
10. Electrical connections—
- (a) All indicators on one side of a vehicle together with all indicators on that side of any trailer drawn by the vehicle, while so drawn, shall be operated by one switch;
- (b) All indicators on one side of a vehicle or combination of vehicles showing a flashing light shall flash in phase, except that in the case of a solo motor bicycle, a motor bicycle combination and a pedal cycle, the front and rear direction indicators on one side of the vehicle may flash alternately.
11. Tell-tale—
- (a) One or more indicators on each side of a vehicle to which indicators are fitted shall be so designed and fitted that the driver when in his seat can readily be aware when it is in operation; or
- (b) The vehicle shall be equipped with an operational tell-tale for front and rear indicators (including any rear indicator on the rearmost of any trailers drawn by the vehicle).
12. Other requirements—

Status: This is the original version (as it was originally made). This item of legislation is currently only available in its original format.

- (a) Every indicator (other than a semaphore arm, that is an indicator in the form of an illuminated sign which when in operation temporarily alters the outline of the vehicle to the extent of at least 150 mm measured horizontally and is visible from both the front and rear of the vehicle) shall when in operation show a light which flashes constantly at the rate of not less than 60 nor more than 120 flashes per minute. However, in the event of a failure, other than a short-circuit of an indicator, any other indicator on the same side of the vehicle or combination of vehicles may continue to flash, but the rate may be less than 60 or more than 120 flashes per minute. Every indicator shall when in operation perform efficiently regardless of the speed of the vehicle;
- (b) Where two front or rear direction indicators are fitted to a motor vehicle first used on or after 24th January 1996, and two rear direction indicators are fitted to a trailer manufactured on or after 24th January 1996, in each case they shall be fitted so as to form a pair.

13. Definitions—

In this Schedule “approval mark” means either—

- (a) A marking designated as an approval mark by regulation 5 of the Designation of Approval Marks Regulations and shown at item 9 of Schedule 4 to those Regulations; or
 - (b) A marking designated as an approval mark by regulation 4 of the Designation of Approval Marks Regulations and shown at item 6 or, in the case of a solo motor bicycle or a motor bicycle combination, a pedal cycle, a horse-drawn vehicle or a vehicle drawn or propelled by hand, at item 50 of Schedule 2 to those Regulations.
-

Part II

Requirements Relating to Optional Direction Indicators

1. A vehicle shall not be fitted with a total of more than one front indicator nor more than two rear indicators, on each side.
2. Any number of side indicators may be fitted to the side (excluding the front and rear) of a vehicle.
3. The only other requirements prescribed by these Regulations in respect of any which are fitted are those specified in paragraphs 5, 7, 8, 9, 10, 11, 12(a) and 12(b) of Part I.

Status: This is the original version (as it was originally made). This item of legislation is currently only available in its original format.

Part III

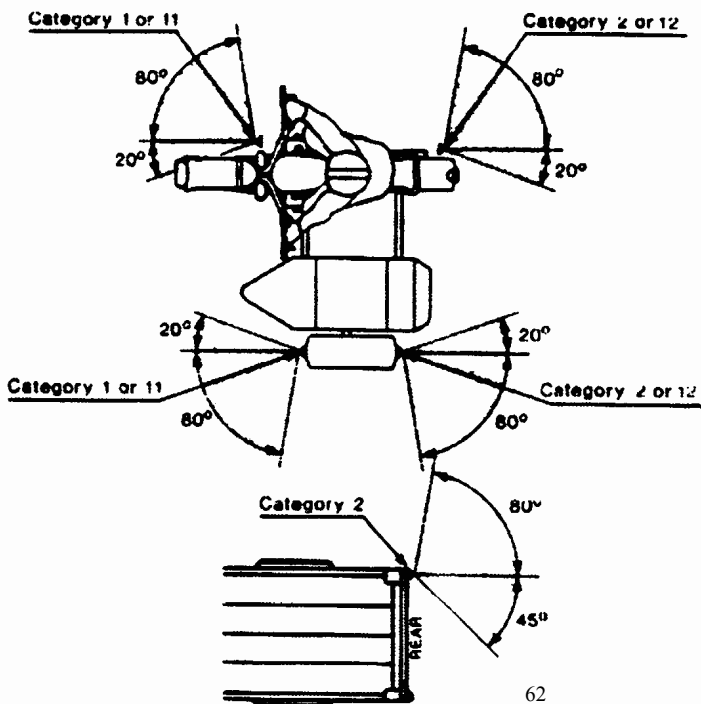
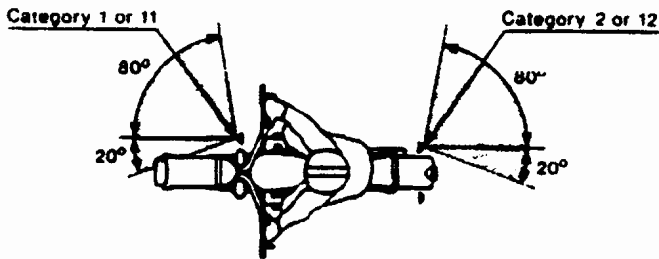
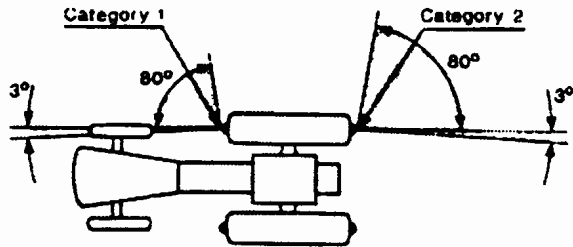
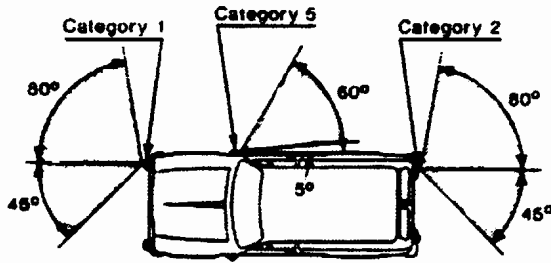

SCHEDULE 8

Regulations 21 and 23

Requirements relating to obligatory and optional hazard warning signal devices

Every hazard warning signal device shall—

- (a) be operated by one switch;
- (b) cause all the direction indicators with which a vehicle or a combination of vehicles is equipped to flash in phase;
- (c) be provided with a circuit-closed tell-tale in the form of a flashing light which may operate in conjunction with any direction indicator tell-tale; and
- (d) be able to function even if the device which controls the starting and stopping of the engine is in a position which makes it impossible to start the engine.

SCHEDULE 9

Regulations 21, 23 and 25

Part I

Requirements Relating to Obligatory Side Marker Lamps and to Optional Side Marker Lamps to the Extent Specified in Part II

1. Number—

- (a) A vehicle not covered by subparagraph (b) which is—
 - (i) (i) a motor vehicle first used on or after 1st January 1997 or a trailer manufactured on or after 1st January 1997: On each side: two and as many more as are sufficient to satisfy the requirements of paragraph 2(a)
 - (ii) (ii) a trailer manufactured before 1st January 1997: One on each side
- (b) Long vehicles and vehicle combinations to which regulation 25 applies: The numbers required by regulation 25

2. Position—

- (a) Longitudinal—
 - (i) (i) A vehicle of a type mentioned in sub-paragraph 1(a)(i)—
 - (A) Maximum distance from the front of the vehicle, including any drawbar, in respect of the foremost side marker lamp on each side: 4 m
 - (B) Maximum distance from the rear of the vehicle in respect of the rearmost side marker lamp on each side: 1 m
 - (C) Maximum separation distance between the light-emitting surfaces of adjacent: 3 m or, if this is not practicable, 4 m

Status: This is the original version (as it was originally made). This item of legislation is currently only available in its original format.

side marker lamps on the same side of the vehicle:

- (ii) (ii) A vehicle of a type mentioned in sub-paragraph 1(a)(ii): Such that no part of the light-emitting surface is forward of, or more than 1530 mm to the rear of, the centre point of the overall length of the trailer
- (iii) (iii) Long vehicles and vehicle combinations, including any loads, to which regulation 25 applies: As specified in regulation 25
- (b) Lateral: No requirement
- (c) Vertical—
 - (i) (i) Maximum height above the ground: 2300 mm
 - (ii) (ii) Minimum height above the ground: No requirement
- 3. Angles of visibility—
 - (a) Horizontal: 45° to the left and to the right when viewed in a direction at right angles to the longitudinal axis of the vehicle
 - (b) Vertical: No requirement
- 4. Alignment: To the side
- 5. Markings: No requirement
- 6. Size of illuminated area: No requirement
- 7. Colour: Amber
or, if within 1 m of the rear of the vehicle it may be red or, if the vehicle is a trailer manufactured before 1st January 1997, it may be white when viewed from the front and red when viewed from the rear
- 8. Wattage: No requirement
- 9. Intensity: Visible from a reasonable distance
- 10. Electrical connections: No individual requirement
- 11. Tell-tale: No requirement

Part II

Requirements Relating to Optional Side Marker Lamps

Any number may be fitted and the only requirement prescribed by these Regulations in respect of any which are fitted is that specified in paragraph 7 of Part I.

SCHEDULE 10

Regulations 21 and 23

Part I

Requirements Relating to Obligatory Rear Position Lamps and to
Optional Rear Position Lamps to the Extent Specified in Part II

1. Number—

(a) Any vehicle not covered by sub-paragraph (b), (c), (d), (e), (f), (g) or (h): Two

(b) A bus first used before 1st October 1958: One

(c) A solo motor bicycle: One

(d) A cycle with less than four wheels and without a sidecar: One

(e) A trailer drawn by a cycle and a trailer, the overall width of which does not exceed 800 mm, drawn by a solo motor bicycle or by a motor bicycle combination: One

(f) An invalid carriage having a maximum speed not exceeding 4 mph: One

(g) A vehicle drawn or propelled by hand: One

(h) A motor vehicle having three or more wheels and a maximum speed not exceeding 25 mph and a trailer drawn by any such vehicle if, in either case, the structure of the vehicle makes it impracticable to meet all of the relevant requirements of paragraphs 2 and 3 with two lamps: Four

2. Position—

(a) Longitudinal: At or near the rear

(b) Lateral—

(i) (i) Where two lamps are required to be fitted—

(A) Maximum distance from the side of the vehicle—

(1) Any vehicle not covered by sub-sub-head (2): 400 mm

(2) A motor vehicle first used before 24th January 1996 and any other vehicle manufactured before 24th January 1996: 800 mm

(B) Minimum separation distance between a pair of rear position lamps—

Status: This is the original version (as it was originally made). This item of legislation is currently only available in its original format.

- | | |
|--|---|
| (1) Any vehicle not covered by sub-sub-head (2): | 500 mm. If the overall width of the vehicle is less than 1400 mm, 400 mm or if less than 800 mm, 300 mm |
| (2) A motor vehicle first used before 24th January 1996 and any other vehicle manufactured before 24th January 1996: | No requirement |
| (ii) (ii) Where one lamp is required to be fitted: | On the centre-line or off side of the vehicle |
| (iii) (iii) Where four lamps are required to be fitted— | |
| (A) Maximum distance from the side of the vehicle— | |
| (1) One pair of lamps: | Such that they satisfy the relevant requirements in sub-head 2(b)(i)(A) |
| (2) The other pair of lamps: | No requirement |
| (B) Minimum separation distance between rear position lamps— | |
| (1) One pair of lamps: | Such that they satisfy the relevant requirements in sub-head 2(b)(i)(B) |
| (2) The other pair of lamps: | No requirement |
| (c) Vertical— | |
| (i) (i) Maximum height above the ground where one or two rear position lamps are required to be fitted— | |
| (A) Any vehicle not covered by sub-head (B) or (C): | 1500 mm or, if the superstructure makes this impracticable, 2100 mm |
| (B) A bus first used before 24th January 1996: | 1050 mm |
| (C) A motor vehicle first used before 24th January 1996 not being a bus, a trailer manufactured before 24th January 1996, an agricultural vehicle, a horse-drawn vehicle, an industrial tractor and engineering plant: | 2100 mm |
| (ii) (ii) Maximum height above the ground where four rear position lamps are required to be fitted— | |
| (A) One pair of lamps: | Such that they satisfy the relevant requirements in paragraph 2(c)(i) |
| (B) The other pair of lamps: | No requirement |
| (iii) (iii) Minimum height above the ground: | 350 mm |

3. Angles of visibility—

(a) A motor vehicle, other than a motor bicycle combination, first used on or after 24th January 1996 and a trailer manufactured on or after 24th January 1996—

(i) (i) Horizontal—

(A) Where two lamps are required to be fitted: 45° inwards and 80° outwards

(B) Where one lamp is required to be fitted: 80° to the left and to the right

(C) Where four lamps are required to be fitted—

(1) The outer pair of lamps: 0° inwards and 80° outwards

(2) The inner pair of lamps: 45° inwards and 80° outwards

(ii) (ii) Vertical—

(A) Where one or two rear position lamps are required to be fitted—

(1) Any vehicle not covered by sub-paragraph (2) or (3): 15° above and below the horizontal

(2) Where the highest part of the illuminated area of the lamp is less than 1500 mm above the ground: 15° above and 10° below the horizontal

(3) Where the highest part of the illuminated area of the lamp is less than 750 mm above the ground: 15° above and 5° below the horizontal

(B) Where four rear position lamps are required to be fitted—

(1) One pair of lamps: Such that they satisfy the relevant requirements in paragraph 3(a)(ii)(A)

(2) The other pair of lamps: Visible to the rear

(b) A motor vehicle, other than a motor bicycle combination, first used before 24th January 1996 and any other vehicle manufactured before 24th January 1996: Visible to the rear

(c) A vehicle drawn or propelled by hand, a pedal cycle, a horse-drawn vehicle and a motor bicycle combination: Visible to the rear

4. Alignment: To the rear

5. Markings (see also regulation 2(5))—

(a) A motor vehicle or a trailer not covered by sub-paragraph (b), (c), (d) or (e): An approval mark

Status: This is the original version (as it was originally made). This item of legislation is currently only available in its original format.

- (b) A motor vehicle first used before 1st January 1974 and a trailer, other than a trailer drawn by a cycle, manufactured before that date: No requirement
 - (c) A solo motor bicycle and a motor bicycle combination, in each case first used before 24th January 1996, and a trailer manufactured before 24th January 1996 and drawn by a solo motor bicycle or a motor bicycle combination: No requirement
 - (d) A cycle, a trailer drawn by a cycle, an invalid carriage having a maximum speed not exceeding 4 mph, a horse-drawn vehicle and a vehicle drawn or propelled by hand in each case manufactured before 24th January 1996: An approval mark or a British Standard mark
 - (e) A cycle, a trailer drawn by a cycle, an invalid carriage having a maximum speed not exceeding 4 mph, a horse-drawn vehicle and a vehicle drawn or propelled by hand in each case manufactured on or after 24th January 1996: An approval mark or the British Standard mark which is specified in sub-paragraph (c) of the definition of “British Standard mark”
6. Size of illuminated area: No requirement
 7. Colour: Red
 8. Wattage: No requirement
 9. Intensity—
 - (a) A rear position lamp bearing any of the markings mentioned in paragraph 5: No requirement
 - (b) Any other rear position lamp: Visible from a reasonable distance
 10. Electrical connections: No individual requirement
 11. Tell-tale: No requirement

12. Other requirements—

Except in the case of a motor vehicle first used before 24th January 1996, any other vehicle manufactured before 24th January 1996 and a motor bicycle combination, where two rear position lamps are required to be fitted they shall form a matched pair and where four rear position lamps are required to be fitted they shall form two matched pairs.

13. Definitions—

In this Schedule “approval mark” means—

- (a) in relation to a solo motor bicycle, a motor bicycle combination and a trailer drawn by a solo motor bicycle or a motor bicycle combination, a marking designated as an approval mark by regulation 4 of the Designation of Approval Marks Regulations and shown at item 50A of Schedule 2 to those Regulations, and
- (b) in relation to any other motor vehicle or any other trailer, either—
 - (i) a marking designated as an approval mark by regulation 5 of the Designation of Approval Marks Regulations and shown at item 6 or, if combined with a stop lamp, at item 8 of Schedule 4 to those Regulations, or

Status: This is the original version (as it was originally made). This item of legislation is currently only available in its original format.

- (ii) a marking designated as an approval mark by regulation 4 of the Designation of Approval Marks Regulations and shown at item 7A or, if combined with a stop lamp, at item 7C of Schedule 2 to those Regulations; and

“British Standard mark” means—

- (a) the mark indicated in the specification for cycle rear lamps published by the British Standards Institution under the reference 3648: 1963 as amended by Amendment PD 6137 published in May 1967 and by AMD 4753 published in July 1985;
- (b) the mark indicated in the specification for photometric and physical requirements for lighting equipment published by the British Standards Institution under the reference BS 6102: Part 3: 1986, namely “BS 6102/3”; or
- (c) the mark indicated in the specification for photometric and physical requirements for lighting equipment published by the British Standards Institution under the reference BS 6102: Part 3: 1986 as amended by AMD 5821 published on the 29th April 1988, namely “6102/3”.

Part II

Requirements Relating to Optional Rear Position Lamps

Any number may be fitted and the only requirement prescribed by these Regulations in respect of any which are fitted is that specified in paragraph 7 of Part I.

SCHEDULE 11

Regulations 21 and 23

Part I

Requirements Relating to Obligatory Rear Fog Lamps and to Optional Rear Fog Lamps to the Extent Specified in Part II

1. Number:	One
2. Position—	
(a) Longitudinal:	At or near the rear of the vehicle
(b) Lateral—	
(i) (i) Where one rear fog lamp is fitted:	On the centre-line or off side of the vehicle (disregarding any sidecar forming part of a motor bicycle combination)
(ii) (ii) Where two lamps are fitted:	No requirement
(c) Vertical—	
(i) (i) Maximum height above the ground—	
(A) Any vehicle not covered by sub-head (B):	1000 mm
(B) An agricultural vehicle, engineering plant and a motor tractor:	2100 mm

Status: This is the original version (as it was originally made). This item of legislation is currently only available in its original format.

- (ii) (ii) Minimum height above the 250 mm ground:
- (d) Minimum separation distance between a rear fog lamp and a stop lamp—
 - (i) (i) In the case of a rear fog lamp which does not share a common lamp body with a stop lamp: A distance of 100 mm between the light-emitting surfaces of the lamps when viewed in a direction parallel to the longitudinal axis of the vehicle
 - (ii) (ii) In the case of a rear fog lamp which shares a common lamp body with a stop lamp: 100 mm
- 3. Angles of visibility—
 - (a) Horizontal: 25° inwards and outwards. However, where two rear fog lamps are fitted it shall suffice if throughout the sector so defined at least one lamp (but not necessarily the same lamp) is visible
 - (b) Vertical: 5° above and below the horizontal
- 4. Alignment: To the rear
- 5. Markings: An approval mark
- 6. Size of illuminated area: No requirement
- 7. Colour: Red
- 8. Wattage: No requirement
- 9. Intensity: No requirement
- 10. Electrical connections: No rear fog lamp shall be fitted to any vehicle so that it can be illuminated by the application of any braking system on the vehicle
- 11. Tell-tale: A circuit-closed tell-tale shall be fitted

12. Other requirements—

Where two rear fog lamps are fitted to any motor vehicle or trailer manufactured on or after 1st May 1980 and first used on or after 1st November 1980 they shall form a matched pair.

13. Definitions—

In this Schedule “approval mark” means either—

- (a) a marking designated as an approval mark by regulation 5 of the Designation of Approval Marks Regulations and shown at item 20 of Schedule 4 to those Regulations; or
- (b) a marking designated as an approval mark by regulation 4 of the Designation of Approval Marks Regulations and shown at item 38 of Schedule 2 to those Regulations.

Part II

Requirements Relating to Optional Rear Fog Lamps

1. In the case of a motor vehicle first used before 1st November 1980 and any other vehicle manufactured before 1st May 1980, any number may be fitted and the only requirements prescribed by these Regulations in respect of any which are fitted are those specified in paragraphs 2(d), 7 and 10 of Part I.

2. In the case of a motor vehicle first used on or after 1st November 1980 and any other vehicle manufactured on or after 1st May 1980, not more than two may be fitted and the requirements prescribed by these Regulations in respect of any which are fitted are all those specified in this Schedule.

SCHEDULE 12

Regulations 21 and 23

Part I

Requirements Relating to Obligatory Stop Lamps and to Optional Stop Lamps to the Extent Specified in Part II

1. Number—

(a) Any vehicle not covered by sub-paragraph (b) or (c): Two

(b) A solo motor bicycle, a motor bicycle combination, an invalid carriage and a trailer drawn by a solo motor bicycle or a motor bicycle combination: One

(c) Any other motor vehicle or trailer first used on or after 1st January 1936 and before 24th January 1996: One

2. Position—

(a) Longitudinal: No requirement

(b) Lateral—

(i) (i) Maximum distance from the side of the vehicle—

(A) Where two stop lamps are fitted: One on each side of the longitudinal axis of the vehicle

(B) Where only one stop lamp is fitted: On the centre-line or off side of the vehicle (disregarding any sidecar forming part of a motor bicycle combination) 400 mm

(ii) (ii) Minimum separation distance between two obligatory stop lamps: 400 mm

(c) Vertical—

Status: This is the original version (as it was originally made). This item of legislation is currently only available in its original format.

- (i) (i) Maximum height above the ground—
 - (A) Any vehicle not covered by sub- head (B): 1500 mm or, if the structure of the vehicle makes this impracticable, 2100 mm
 - (B) A motor vehicle first used before 24th January 1996, a trailer manufactured before that date and a motor vehicle having a maximum speed not exceeding 25 mph: No requirement
- (ii) (ii) Minimum height above the ground—
 - (A) Any vehicle not covered by sub- head (B): 350 mm
 - (B) A motor vehicle first used before 24th January 1996 and a trailer manufactured before that date: No requirement
- 3. Angles of visibility—
 - (a) A motor vehicle first used on or after 24th January 1996 and a trailer manufactured on or after that date—
 - (i) (i) Horizontal: 45° to the left and to the right
 - (ii) (ii) Vertical—
 - (A) Except in a case specified in sub- head (B) or (C): 15° above and below the horizontal
 - (B) Where the highest part of the illuminated area of the lamp is less than 1500 mm above the ground: 15° above and 10° below the horizontal
 - (C) Where the highest part of the illuminated area of the lamp is less than 750 mm above the ground: 15° above and 5° below the horizontal
 - (b) (b) A motor vehicle first used before 24th January 1996 and a trailer manufactured before that date: Visible to the rear
- 4. Alignment: To the rear
- 5. Markings—
 - (a) (a) Any vehicle not covered by sub- paragraph (b) or (c): An approval mark
 - (b) (b) A motor vehicle first used before 24th January 1996 and a trailer manufactured before that date: No requirement
 - (c) A solo motor bicycle and a motor bicycle combination, in each case first used before 24th January 1996, and a trailer manufactured before: No requirement

24th January 1996 drawn by a solo motor bicycle or a motor bicycle combination:

6. Size of illuminated area: No requirement

7. Colour: Red

8. Wattage—

(a) A stop lamp fitted to a motor vehicle first used before 24th January 1996 or a trailer manufactured before that date and a stop lamp bearing an approval mark: No requirement

(b) Any other stop lamp: 15 to 36 watts

9. Intensity: No requirement

10. Electrical connections—

(a) Every stop lamp fitted to—

(i) (i) a solo motor bicycle or a motor bicycle combination first used on or after 24th January 1996 shall be operated by the application of every service brake control provided for the use of the rider;

(ii) (ii) any other motor vehicle, shall be operated by the application of the service braking system;

(b) Every stop lamp fitted to a trailer drawn by a motor vehicle shall be operated by the application of the service braking system of that motor vehicle.

11. Tell-tale: No requirement

12. Other requirements—

Where two stop lamps are required to be fitted, they shall form a pair.

13. Definitions—

In this Schedule “approval mark” means—

(a) in relation to a solo motor bicycle, a motor bicycle combination or a trailer drawn by a solo motor bicycle or a motor bicycle combination, a marking designated as an approval mark by regulation 4 of the Designation of Approval Marks Regulations and shown at item 50A of Schedule 2 to those Regulations; and

(b) in relation to any other vehicle, either—

(i) a marking designated as an approval mark by regulation 5 of the Designation of Approval Marks Regulations and shown at item 7 or, if combined with a rear position lamp, at item 8 of Schedule 4 to those Regulations; or

(ii) a marking designated as an approval mark by regulation 4 of the Designation of Approval Marks Regulations and shown at item 7B or, if combined with a rear position lamp, at item 7C of Schedule 2 to those Regulations.

Status: This is the original version (as it was originally made). This item of legislation is currently only available in its original format.

Part II

Requirements Relating to Optional Stop Lamps

Any number may be fitted, and the requirements prescribed by these Regulations in respect of any which are fitted are all those specified in Part I except—

- (a) those specified in paragraphs 1, 2 and 3;
- (b) in the case of a stop lamp fitted to a pedal cycle, those specified in paragraphs 5 and 8; and
- (c) in the case of a stop lamp fitted to a motor vehicle not being a motor bicycle, first used on or after 24th January 1996 either centrally or in such a manner as to project light through the rear window the intensity of the light emitted to the rear of the vehicle shall be not less than 20 candelas and not more than 60 candelas when measured from directly behind the centre of the lamp in a direction parallel to the longitudinal axis of the vehicle.

SCHEDULE 13

Regulations 21 and 23

Part I

Requirements Relating to Obligatory End-Outline Marker Lamps and to Optional End-Outline Marker Lamps to the Extent Specified in Part II

1. Number:	Two visible from the front and two visible from the rear
2. Position—	
(a) (a) Longitudinal	No requirement
(b) (b) Lateral—	
(i) Maximum distance from the side of the vehicle:	400 mm
(ii) Minimum separation distance between a pair of end-outline marker lamps:	No requirement
(c) (c) Vertical—	
(i) At the front of a motor vehicle:	The horizontal plane tangential to the upper edge of the illuminated area of the lamp shall not be lower than the horizontal plane tangential to the upper edge of the transparent zone of the windscreen
(ii) At the front of a trailer and at the rear of any vehicle:	At the maximum height compatible with: <ul style="list-style-type: none"> (a) the requirements relating to the lateral position and to being a pair, and (b) the use for which the vehicle is constructed
3. Angles of visibility—	
(a) (a) Horizontal:	0° inwards and 80° outwards

- | | |
|------------------------------|--|
| (b) (b) Vertical: | 5° above and 20° below the horizontal |
| 4. Alignment: | Such that white light is shown towards the front and red light is shown towards the rear |
| 5. Markings: | An approval mark |
| 6. Size of illuminated area: | No requirement |
| 7. Colour: | White towards the front and red towards the rear |
| 8. Wattage: | No requirement |
| 9. Intensity: | No requirement |
| 10. Electrical connections: | No individual requirement |
| 11. Tell-tale: | No requirement |
| 12. Other requirements— | |
| | The two lamps which emit white light towards the front, and the two lamps which emit red light towards the rear, shall in each case form a matched pair. |
| | The white front lamp and red rear lamp on one side of a vehicle may be combined into a single lamp with a single light source. |
| 13. Definitions— | |

In this Schedule, “approval mark” means the approval mark for a front or rear position lamp, as the case may be.

Part II

Requirements Relating to Optional End-Outline Marker Lamps

Any number may be fitted, and the only requirement prescribed by these Regulations in respect of any which are fitted is that specified in paragraph 7 of Part I.

SCHEDULE 14

Regulation 23

Requirements relating to optional reversing lamps

- | | |
|---|-------------------|
| 1. Number: | Not more than two |
| 2. Position: | No requirement |
| 3. Angles of visibility: | No requirement |
| 4. Alignment: | To the rear |
| 5. Markings— | |
| (a) A motor vehicle first used on or after or a trailer manufactured on or after 24th January 1996: | An approval mark |
| (b) Any other motor vehicle: | No requirement |

Status: This is the original version (as it was originally made). This item of legislation is currently only available in its original format.

- 6. Size of illuminated area: No requirement
- 7. Colour: White
- 8. Wattage—
 - (a) A reversing lamp bearing an approval mark: No requirement
 - (b) A reversing lamp not bearing an approval mark: The total wattage of any one reversing lamp shall not exceed 24 watts
- 9. Intensity: No requirement
- 10. Electrical connections: No requirement
- 11. Tell-tale—
 - (a) A motor vehicle first used on or after 1st July 1954, provided that the electrical connections are such that the reversing lamp or lamps cannot be illuminated other than automatically by the selection of the reverse gear of the vehicle: No requirement
 - (b) Any other motor vehicle first used on or after 1st July 1954: A circuit-closed tell-tale shall be fitted
 - (c) A motor vehicle first used before 1st July 1954: No requirement
 - (d) Any vehicle which is not a motor vehicle: No requirement

12. Definitions—
- In this Schedule “approval mark” means either—
- (a) a marking designated as an approval mark by regulation 5 of the Designation of Approval Marks Regulations and shown at item 21 of Schedule 4 to those Regulations; or
 - (b) a marking designated as an approval mark by regulation 4 of the Designation of Approval Marks Regulations and shown at item 23 or 23A of Schedule 2 to those Regulations.

SCHEDULE 15

Regulation 21

Requirements relating to obligatory rear registration plate lamps

- 1. Number: Such that the lamp or lamps are capable of adequately illuminating the rear registration plate
- 2. Position:
- 3. Angles of visibility:
- 4. Alignment:
- 5. Markings—
 - (a) A motor vehicle first used on or after 24th January 1996 and a trailer manufactured on or after 24th January 1996 : An approval mark

(b) Any other vehicle:	No requirement
6. Size of illuminated area:	No requirement
7. Colour:	White
8. Wattage:	No requirement
9. Intensity:	No requirement
10. Electrical connections:	No individual requirement
11. Tell-tale:	No requirement

12. Definitions—

In this Schedule “approval mark” means—

- (a) in relation to a solo motor bicycle, a motor bicycle combination and a trailer drawn by a solo motor bicycle or a motor bicycle combination, a marking designated as an approval mark by regulation 4 of the Designation of Approval Marks Regulations and shown at item 50A of Schedule 2 to those Regulations; and
- (b) in relation to any other motor vehicle and any other trailer, either—
 - (i) a marking designated as an approval mark by regulation 5 of the Designation of Approval Marks Regulations and shown at item 10 of Schedule 4 to those Regulations; or
 - (ii) a marking designated as an approval mark by regulation 4 of the Designation of Approval Marks Regulations and shown at item 4 of Schedule 2 to those Regulations.

SCHEDULE 16

Regulations 20 and 23

Requirement relating to obligatory and optional warning beacons

1. Number:	Sufficient to satisfy the requirements of paragraph 3
2. Position—	
Every warning beacon shall be so mounted on the vehicle that the centre of the lamp is at a height not less than 380 mm above the ground.	
3. Angles of visibility—	
Except in the case of a motor vehicle used for police purposes the light shown from at least one beacon (but not necessarily the same beacon) shall be visible from any point at a reasonable distance from the vehicle or any trailer being drawn by it.	
4. Markings:	No requirement
5. Size of illuminated area:	No requirement
6. Colour:	Blue, amber, green or yellow in accordance with Regulation 13
7. Wattage:	No requirement

The light shown by any one warning beacon shall be displayed not less than 60 nor more than 240 equal times per minute and the intervals between each display of light shall be constant.

Status: This is the original version (as it was originally made). This item of legislation is currently only available in its original format.

- 8. Intensity: No requirement
- 9. Electrical connections: No requirement
- 10. Tell-tale: No requirement
- 11. Other requirements—

The light shown by any one warning beacon shall be displayed not less than 60 nor more than 240 equal times per minute and the intervals between each display of light shall be constant.

SCHEDULE 17

Regulations 21 and 23

Part I

Requirements Relating to Obligatory Side Retro Reflectors and
Optional Side Retro Reflectors to the Extent Specified in Part II

1. Number—

- (a) A motor vehicle first used on or after 24th January 1996 and a trailer manufactured on or after 24th January 1996: On each side: two and as many more as are sufficient to satisfy the requirements of paragraph 2(a)
- (b) A motor vehicle first used before 24th January 1996 and a trailer manufactured before 24th January 1996: On each side: two

2. Position—

(a) Longitudinal—

- (i) (i) A motor vehicle first used on or after 24th January 1996 and a trailer manufactured on or after 24th January 1996—

- (A) Maximum distance from the front of the vehicle, including any drawbar, in respect of the foremost reflector on each side: 4 m
- (B) Maximum distance from the rear of the vehicle in respect of the rearmost reflector on each side: 1 m
- (C) Maximum separation distance between the reflecting areas of adjacent reflectors on the same side of the vehicle: 3 m or, if this is not practicable, 4 m
- (ii) (ii) A motor vehicle first used before 24th January 1996 and a trailer manufactured before 24th January 1996—

- (A) Maximum distance from the rear of the vehicle in respect of the rearmost reflector on each side: 500 mm
- (B) The other reflector on each side of the vehicle: Towards the centre of the vehicle
- (b) Lateral: No requirement
- (c) Vertical—
- (i) (i) Maximum height above the ground: 1500 mm
- (ii) (ii) Minimum height above the ground: 350 mm
3. Angles of visibility—
- (a) A motor vehicle first used on or after 24th January 1996 and a trailer manufactured on or after 24th January 1996—
- (i) (i) Horizontal: 45° to the left and to the right when viewed in a direction at right angles to the longitudinal axis of the vehicle
- (ii) (ii) Vertical—
- (A) Except in a case specified in sub- head (B): 15° above and below the horizontal
- (B) Where the highest part of the reflecting area is less than 750 mm above the ground: 15° above and 5° below the horizontal
- (b) A motor vehicle first used before 24th January 1996 and a trailer manufactured before 24th January 1996: Plainly visible to the side
4. Alignment: To the side
5. Markings: An approval mark
6. Size of reflecting area: No requirement
7. Colour—
- (a) Any vehicle not covered by sub-paragraph (b): Amber or if within 1 m of the rear of the vehicle it may be red
- (b) A solo motor bicycle, a motor bicycle combination, a pedal cycle with or without a sidecar or an invalid carriage: No requirement
8. Other requirements: No side retro reflector shall be triangular
-
9. Definitions—
- (a) In this Schedule “approval mark” means either—

Status: This is the original version (as it was originally made). This item of legislation is currently only available in its original format.

- (i) a marking designated as an approval mark by regulation 4 of the Designation of Approval Marks Regulations and shown at item 3 or 3B of Schedule 2 to those Regulations and which includes the marking 1 or 1A; or
 - (ii) a marking designated as an approval mark by regulation 5 of the Designation of Approval Marks Regulations and shown at item 4 of Schedule 4 to those Regulations and which includes the marking I; and
- (b) In this Schedule references to “maximum distance from the front of the vehicle” and “maximum distance from the rear of the vehicle” are references to the maximum distance from that end of the vehicle (as determined by reference to the overall length of the vehicle exclusive of any special equipment) beyond which no part of the reflecting area of the side retro reflector extends.

Part II

Requirements Relating to Optional Side Retro Reflectors

Any number may be fitted, and the only requirements prescribed by these Regulations in respect of any which are fitted are—

- (a) those specified in paragraph 7 of Part I, except in the case of vehicles used for police purposes which may also be capable of reflecting one or more of the colours yellow, blue and white; and
- (b) those specified in paragraph 8 of Part I.

SCHEDULE 18

Regulations 21 and 23

Part I

Requirements Relating to Obligatory Rear Retro Reflectors and Optional Rear Retro Reflectors to the Extent Specified in Part II

1. Number—

(a) Any vehicle not covered by sub-paragraph (b) or (c):

(b) A solo motor bicycle, a cycle with one less than four wheels and with or without a sidecar, a trailer drawn by a cycle, a trailer the overall width of which does not exceed 800 mm drawn by a solo motor bicycle or a motor bicycle combination, an invalid carriage having a maximum speed not exceeding 4 mph and a vehicle drawn or propelled by hand:

(c) A motor vehicle having three or more wheels and a maximum speed not exceeding 25 mph and a trailer drawn by any such vehicle if, in either case, the structure of the vehicle makes

it impracticable to meet all of the requirements of paragraphs 2 and 3 below with two reflectors:

2. Position—

(a) Longitudinal: At or near the rear

(b) Lateral—

(i) (i) Where two rear reflectors are required to be fitted—

(A) Maximum distance from the side of the vehicle—

(1) Any vehicle not covered by sub-head (2), (3) or (4): 400 mm

(2) A bus first used before 1st October 1954 and a horse-drawn vehicle manufactured before January 1996: No requirement

(3) A vehicle constructed or adapted for the carriage of round timber: 765 mm

(4) Any other motor vehicle first used before 24th January 1996 and any other vehicle manufactured before 24th January 1996: 610 mm

(B) Minimum separation distance between a pair of rear reflectors: 600 mm. If the overall width of the vehicle is less than 1300 mm, 400 mm or if less than 800 mm, 300 mm

(ii) (ii) Where one rear reflector is required to be fitted: On the centre-line or off side of the vehicle

(iii) (iii) Where four rear reflectors are required to be fitted—

(A) Maximum distance from the side of the vehicle—

(1) One pair of reflectors: Such that they satisfy the relevant requirements in sub-head 2(b)(i)(A)

(2) The other pair of reflectors: No requirement

(B) Minimum separation distance between rear reflectors—

(1) One pair of reflectors: Such that they satisfy the relevant requirements in sub-head 2(b)(i)(B)

(2) The other pair of reflectors: No requirement

(c) Vertical—

(i) (i) Maximum height above the ground where one or two rear reflectors are required to be fitted—

Status: This is the original version (as it was originally made). This item of legislation is currently only available in its original format.

- (A) any vehicle not covered by head (B): 900 mm or, if the structure of the vehicle makes this impracticable, 1200 mm
- (B) A motor vehicle first used before 24th January 1996 and any other vehicle manufactured before 24th January 1996: 1500 mm
 - (ii) (ii) Maximum height above the ground where four rear reflectors are required to be fitted—
- (A) One pair of reflectors: Such that they satisfy the relevant requirements in paragraph 2(c)(i)
- (B) The other pair of reflectors: 2100 mm
 - (iii) (iii) Minimum height above the ground—
- (A) Any vehicle not covered by sub-head (B): 350 mm
- (B) A motor vehicle first used before 24th January 1996 and any other vehicle manufactured before 24th January 1996: 400 mm
- 3. Angles of visibility—
 - (a) A motor vehicle (not being a motor bicycle combination) first used on or after 24th January 1996 and a trailer manufactured on or after 24th January 1996—
 - (i) (i) Where one or two rear reflectors are required to be fitted—
 - (A) Horizontal—
 - (1) Where two rear reflectors are required to be fitted: 30° inwards and outwards
 - (2) Where one rear reflector is required to be fitted: 30° to the left and to the right
 - (B) Vertical—
 - (1) Except in a case specified in sub- head (2): 15° above and below the horizontal
 - (2) Where the highest part of the reflecting area is less than 750 mm above the ground: 15° above and 5° below the horizontal
 - (ii) (ii) Where four rear reflectors are required to be fitted—
 - (A) One pair of reflectors: Such that they satisfy the relevant requirements in paragraph 3(a)(i)
 - (B) The other pair of reflectors: Plainly visible to the rear
 - (b) A motor vehicle (not being a motor bicycle combination) first used before 24th

January 1996 and a trailer manufactured before 24th January 1996:

(c) A motor bicycle combination, a cycle, Plainly visible to the rear a sidecar attached to a cycle, a horse-drawn vehicle and a vehicle drawn or propelled by hand:

4. Alignment: To the rear

5. Markings—

(a) A motor vehicle first used—

- (i) (i) On or after 24th January 1996: (A) An approval mark in-corporating “I” or “IA”; or
(B) A British Standard mark which is specified in sub-paragraph (i) of the definition of “British Standard mark” below followed by “L” or “LIA”; or
(C) In the case of a trailer manufactured in Italy, an Italian approved marking

(ii) (ii) Any other vehicle: No requirement

(b) A trailer (other than a broken-down motor vehicle) manufactured—

- (i) (i) On or after 24th January 1996: (A) An approval mark incorporating “III” or “IIIA”; or
(B) A British Standard mark which is specified in sub-paragraph (i) of the definition of “British Standard mark” below followed by “LIII” or “LIIIA”; or
(C) In the case of a vehicle manufactured in Italy, an Italian approved marking

(ii) (ii) Any other trailer: No requirement

(c) A cycle, an invalid carriage having a maximum speed not exceeding 4 mph, a horse-drawn vehicle and a vehicle drawn or propelled by hand, in each case manufactured—

- (i) (i) On or after 24th January 1996: (A) An approval mark incorporating “I” or “IA”; or
(B) A British Standard mark which is specified in sub-paragraph (i) of the definition of “British Standard mark” below followed by “LI” or “LIA”; or
(C) A British Standard mark which is specified in sub-paragraph (ii) of the definition of “British Standard mark” below

(ii) (ii) Any other vehicle: No requirement

Status: This is the original version (as it was originally made). This item of legislation is currently only available in its original format.

6. Size of reflecting area: No requirement
7. Colour: Red
8. Other requirements—

(a) except in the case of a motor vehicle first used before 24th January 1996, any other vehicle manufactured before 24th January 1996 and a motor bicycle combination, where two rear reflectors are required to be fitted they shall form a pair. Where four rear reflectors are required to be fitted they shall form two pairs;

(b) no vehicle, other than a trailer or a broken-down motor vehicle being towed, may be fitted with triangular-shaped rear reflectors.

9. Definitions—

In this Schedule—

- (a) “approval mark” means either—
- (i) a marking designated as an approval mark by regulation 4 of the Designation of Approval Marks Regulations and shown at item 3 or 3A or 3B of Schedule 2 to those Regulations; or
 - (ii) a marking designated as an approval mark by regulation 5 of the Designation of Approval Marks Regulations and shown at item 4 of Schedule 4 to those Regulations;
- (b) “British Standard mark” means either—
- (i) the mark indicated in the specification for retro reflectors for vehicles, including cycles, published by the British Standards Institution under the reference B.S. AU 40: Part 2: 1965, namely “AU 40”; or
 - (ii) the mark indicated in the specification for photometric and physical requirements of reflective devices published by the British Standards Institution under the reference BS 6102: Part 2: 1982, namely “BS 6102/2”; and
- (c) “Italian approved marking” means—

a mark approved by the Italian Ministry of Transport, namely, one including two separate groups of symbols consisting of “IGM” or “DGM” and “C.I.” or “C.2.”.

Part II

Requirements Relating to Optional Rear Retro Reflectors

Any number may be fitted and the only requirements prescribed by these Regulations in respect of any which are fitted are—

- (a) those specified in paragraphs 7 of Part I, except in the case of vehicles used for police purposes, which may also be capable of reflecting one or more of the colours yellow and orange; and
- (b) those specified in paragraph 8(b) of Part I.

SCHEDULE 19

Regulations 13(3), 21 and 23

Part I

Requirements Relating to Obligatory Rear Markings and
Optional Rear Markings to the Extent Specified in Part II

General Requirements

1. Description—

- (a) A motor vehicle first used on or after 24th January 1996, the overall length of which—
- | | | |
|------|---------------------------|--|
| (i) | (i) does not exceed 13 m: | A rear marking of a type shown in diagram 1, 2, 3 or 4 in Part IV of this Schedule |
| (ii) | (ii) exceeds 13 m: | A rear marking of a type shown in diagram 5, 6, 7 or 8 in Part IV of this Schedule |
- (b) A motor vehicle first used before 24th January 1996, the overall length of which—
- | | | |
|------|---------------------------|--|
| (i) | (i) does not exceed 13 m: | A rear marking of a type shown in diagram 1, 2 or 3 in Part III of this Schedule or a rear marking of a type shown in diagram 1, 2, 3 or 4 in Part IV of this Schedule |
| (ii) | (ii) exceeds 13 m: | A rear marking of a type shown in diagram 4 or 5 in Part III of this Schedule or a rear marking of a type shown in diagram 5, 6, 7 or 8 in Part IV of this Schedule |
- (c) A trailer manufactured on or after 24th January 1996 if it forms part of a combination of vehicles the overall length of which—
- | | | |
|-------|---|--|
| (i) | (i) does not exceed 11 m: | A rear marking of a type shown in diagram 1, 2, 3 or 4 in Part IV of this Schedule |
| (ii) | (ii) exceeds 11 m but does not exceed 13 m: | A rear marking of a type shown in Part IV of this Schedule |
| (iii) | (iii) exceeds 13 m: | A rear marking of a type shown in diagram 5, 6, 7 or 8 in Part IV of this Schedule |
- (d) A trailer manufactured before 24th January 1996 if it forms part of a combination of vehicles the overall length of which—
- | | | |
|------|---|--|
| (i) | (i) does not exceed 11 m: | A rear marking of a type shown in diagram 1, 2 or 3 in Part III of this Schedule or a rear marking of a type shown in diagram 1, 2, 3 or 4 in Part IV of this Schedule |
| (ii) | (ii) exceeds 11 m but does not exceed 13 m: | A rear marking of a type shown in Part III or Part IV of this Schedule |

Status: This is the original version (as it was originally made). This item of legislation is currently only available in its original format.

- (iii) (iii) exceeds 13 m: A rear marking of a type shown in diagram 4 or 5 in Part III of this Schedule or a rear marking of a type shown in diagram 5, 6, 7 or 8 in Part IV of this Schedule
2. Position—
- (a) Longitudinal: At or near the rear of the vehicle
- (b) Lateral—
- (i) (i) A rear marking of a type shown in diagram 2, 3 or 5 in Part III of this Schedule and a rear marking of a type shown in diagram 2, 3, 4, 6, 7 or 8 in Part IV of this Schedule: Each part shall be fitted as near as practicable to the outermost edge of the vehicle on the side thereof on which it is fitted so that no part of the marking projects beyond the outermost part of the vehicle on either side
- (ii) (ii) A rear marking of a type shown in diagram 1 or 4 in Part III of this Schedule and a rear marking of a type shown in diagram 1 or 5 in Part IV of this Schedule: The marking shall be fitted so that the vertical centre-line of the marking lies on the vertical plane through the longitudinal axis of the vehicle and no part of the marking projects beyond the outermost part of the vehicle on either side
- (c) Vertical: The lower edge of every rear marking shall be at a height of not more than 1700 mm nor less than 400 mm above the ground whether the vehicle is laden or unladen
3. Visibility: Plainly visible to the rear
4. Alignment: The lower edge of every rear marking shall be fitted horizontally. Every part of a rear marking shall lie within 20° of a transverse vertical plane at right angles to the longitudinal axis of the vehicle and shall face to the rear
5. Markings—
- (a) A motor vehicle or trailer not covered by sub-paragraph (b): In respect of any rear marking of a type shown in Part III of this Schedule a British Standard mark or in respect of any rear marking of a type shown in Part IV of this Schedule an approval mark
- (b) A motor vehicle first used on or after 24th January 1996 and a trailer manufactured on or after 24th January 1996: An approval mark
6. Colour: Red fluorescent material in the stippled areas shown in any of the diagrams in Part III or IV of this Schedule and yellow retro reflective material in any of the areas so shown, being areas not stippled and not constituting a letter. All letters shall be coloured black
-
7. Other requirements—

Status: This is the original version (as it was originally made). This item of legislation is currently only available in its original format.

A rear marking of a type shown in a diagram in Part III of this Schedule shall comply with the requirements of that Part.

The two parts of every rear marking of a type shown in diagrams 2, 3 and 5 in Part III and diagrams 2, 3, 6 and 7 in Part IV of this Schedule shall form a pair and the four parts of every rear marking of a type shown in diagrams 4 and 8 in Part IV of this Schedule shall form two pairs.

8. Definitions—

In this Schedule—

- (a) “approval mark” means a marking designated as an approval mark by regulation 3 of the Designation of Approval Marks Regulations and shown at item 70 of Schedule 2 to those Regulations; and
- (b) “British Standard mark” means the specification for rear markings for vehicles published by the British Standards Institution under the reference BS AU 152: 1970, namely “BS AU 152”.



Part II

Requirements Relating to Optional Rear Markings

Subject to regulation 14(2), any number of rear markings shown in Parts III and IV may be fitted to the rear of a vehicle.

Part III

Rear Markings Prescribed for Motor Vehicles First Used Before 24th January 1996 and Trailers Manufactured Before 24th January 1996

Left	Right
Diagram 1.	
Diagram 2.	

Status: This is the original version (as it was originally made). This item of legislation is currently only available in its original format.

Left	Right
------	-------

Diagram 3.



Diagram 4.



Diagram 5.



Additional Provisions Relating to the above Diagrams

1. A rear marking of a type shown in one of the above diagrams shall have the dimensions shown in relation to that diagram.
2. Any variation in a dimension (other than as to the height of a letter) specified in any of the above diagrams shall be treated as permitted for the purposes of this Schedule if the variation—
 - (a) in the case of a dimension so specified as 250 mm or as over 250 mm does not exceed 2.5 per cent. of that dimension;
 - (b) in the case of a dimension so specified as 40 mm or as over 40 mm but as under 250 mm does not exceed 5 per cent. of that dimension; or
 - (c) in the case of a dimension so specified as under 40 mm does not exceed 10 per cent. of that dimension.
3. Any variation in a dimension as to the height of a letter specified in any of those diagrams shall be treated as permitted for the purposes of this Schedule if the variation —
 - (a) in the case of a dimension so specified as 105 mm does not exceed 2.5 per cent. of that dimension; or
 - (b) in the case of a dimension so specified as 70 mm does not exceed 5 per cent. of that dimension.
4. Any variation in a dimension as to the angle of hatching specified in any of those diagrams shall be treated as permitted for the purposes of the Schedule if the variation does not exceed 5 degrees.
5. A rear marking of a type shown in diagrams 1 or 4 above shall be constructed in the form of a single plate, and every rear marking shown in diagrams 2, 3 or 5 above shall be constructed in the form of two plates of equal size and shape.





Status: This is the original version (as it was originally made). This item of legislation is currently only available in its original format.

6. The height of each half of the marking shown in diagram 3 above may be reduced to a minimum of 140 mm provided the width is increased so that each half of the marking has a minimum area of 980 cm².

7. All letters incorporated in a rear marking of a type shown in diagrams 4 or 5 above shall have the proportions and form of letters as shown in Schedule 25.

Part IV

Rear Markings Prescribed for Motor Vehicles Whenever First Used and Trailers Whenever Manufactured

Left	Right
Diagram 1.	
Diagram 2.	
Diagram 3.	
Diagram 4.	

Status: This is the original version (as it was originally made). This item of legislation is currently only available in its original format.

Left	Right
------	-------

Diagram 5.



Diagram 6.



Diagram 7.



Diagram 8.



SCHEDULE 20

Regulation 21 and 23

Part I

Requirements Relating to Obligatory Pedal Retro Reflectors and Optional Pedal Retro Reflectors to the Extent Specified in Part II

1. Number:	Two reflectors on each pedal
2. Position—	
(a) Longitudinal:	On the leading edge and the trailing edge of each pedal
(b) Lateral:	No requirement
(c) Vertical:	No requirement
3. Angles of visibility:	Such that the reflector on the leading edge of each pedal is plainly visible to the front and the reflector on the trailing edge of each pedal is plainly visible to the rear
4. Markings:	A British Standard mark
5. Size of reflecting area:	No requirement
6. Colour:	Amber
7. Definitions—	

In this Schedule “British Standard mark” means the specification or photometric and physical requirements of reflective devices published by the British Standards Institution under the reference BS 6102: Part 2: 1982, namely “BS 6102/2”.

Part II

Requirements Relating to Optional Pedal Retro Reflectors

Any number may be fitted and the only requirement prescribed by these Regulations in respect of any which are fitted is that specified in paragraph 6 of Part I.

SCHEDULE 21

Regulations 21 and 23

Part I

Requirements Relating to Obligatory Front Retro Reflectors and to Optional Front Retro Reflectors to the Extent Specified in Part II

1. Number:	Two
2. Position—	

Status: This is the original version (as it was originally made). This item of legislation is currently only available in its original format.

- (a) Longitudinal: No requirement
- (b) Lateral—
 - (i) (i) Maximum distance from the side of the trailer: 150 mm
 - (ii) (ii) Minimum separation distance between a pair of front reflectors: 600 mm or, if the overall width of the trailer is less than 1400 mm, 400 mm
- (c) Vertical—
 - (i) (i) Maximum height above the ground: 900 mm or, if the structure of the trailer makes this impracticable, 1500 mm
 - (ii) (ii) Minimum height above the ground: 350 mm
- 3. Angles of visibility—
 - (a) Horizontal: 30° outwards and 5° inwards
 - (b) Vertical—
 - (i) (i) Any case not covered by sub-paragraph (ii): 15° above and below the horizontal
 - (ii) (ii) Where the highest point of the reflecting area is less than 750 mm above the ground: 15° above and 5° below the horizontal
- 4. Alignment: To the front
- 5. Markings: An approval mark
- 6. Size of reflecting area: No requirement
- 7. Colour: White

8. Other requirements—

- (a) Where two front reflectors are required to be fitted they shall form a pair.
- (b) Triangular shaped retro reflectors shall not be fitted to the front of any trailer.

9. Definitions—

In this Schedule—

“approval mark” means either—

- (a) a marking designated as an approval mark by regulation 4 of the Designation of Approval Marks Regulations and shown at item 3 or 3A or 3B of Schedule 2 to those Regulations; or
- (b) a marking designated as an approval mark by regulation 5 of the Designation of Approval Marks Regulation and shown at item 4 of Schedule 4 to those Regulations.

Part II

Requirements Relating to Optional Front Retro Reflectors

Any number may be fitted and the only requirements prescribed by these Regulations in respect of any which are fitted are that specified in paragraph 8(b) of Part I and that the colour shall not be red.

SCHEDULE 22

Regulation 2(1)

Prescribed sign for buses carrying children



Colour

Shaded areas — yellow retro reflective material

Border and silhouette — black

Dimensions

(A) Front — not less than 250 mm	(A) Front — not more than 20 mm
Rear — not less than 400 mm	Rear — not less than 30 mm

Status: This is the original version (as it was originally made). This item of legislation is currently only available in its original format.

SCHEDULE 23

Regulation 27(6)

Diagram showing where unlit parking is not permitted near a junction

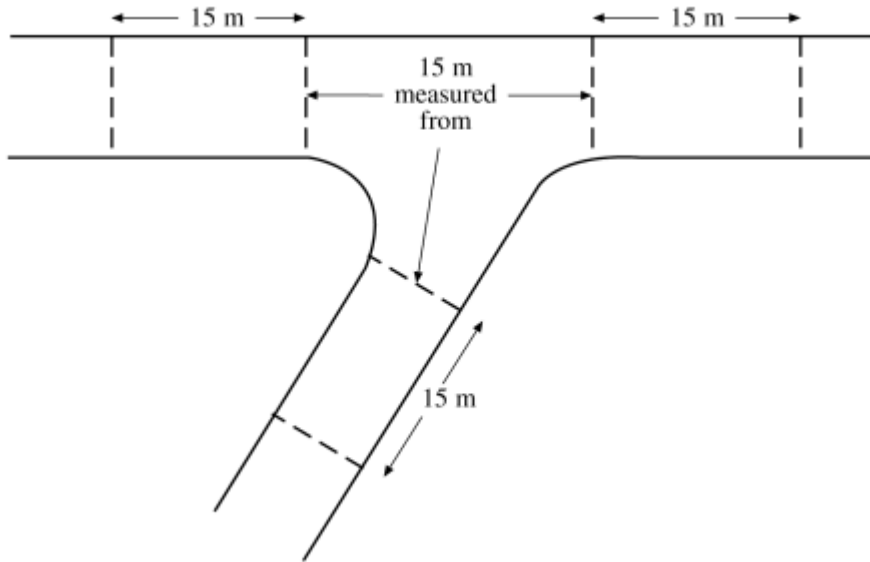

SCHEDULE 24

Schedule 4, Part 1, Paragraph 12

Example of marking showing the vertical downwards inclination of the dipped-beam headlamps when the vehicle is at its kerbside weight and has a weight of 75 kg on the driver's seat

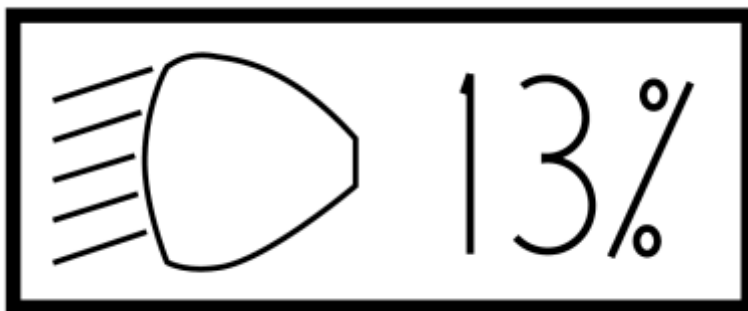

Symbol for dipped-beam headlamp

Vertical inclination of dipped-beam

SCHEDULE 25

Regulations 21 and 23

Proportions and form of letters, numerals and other characters

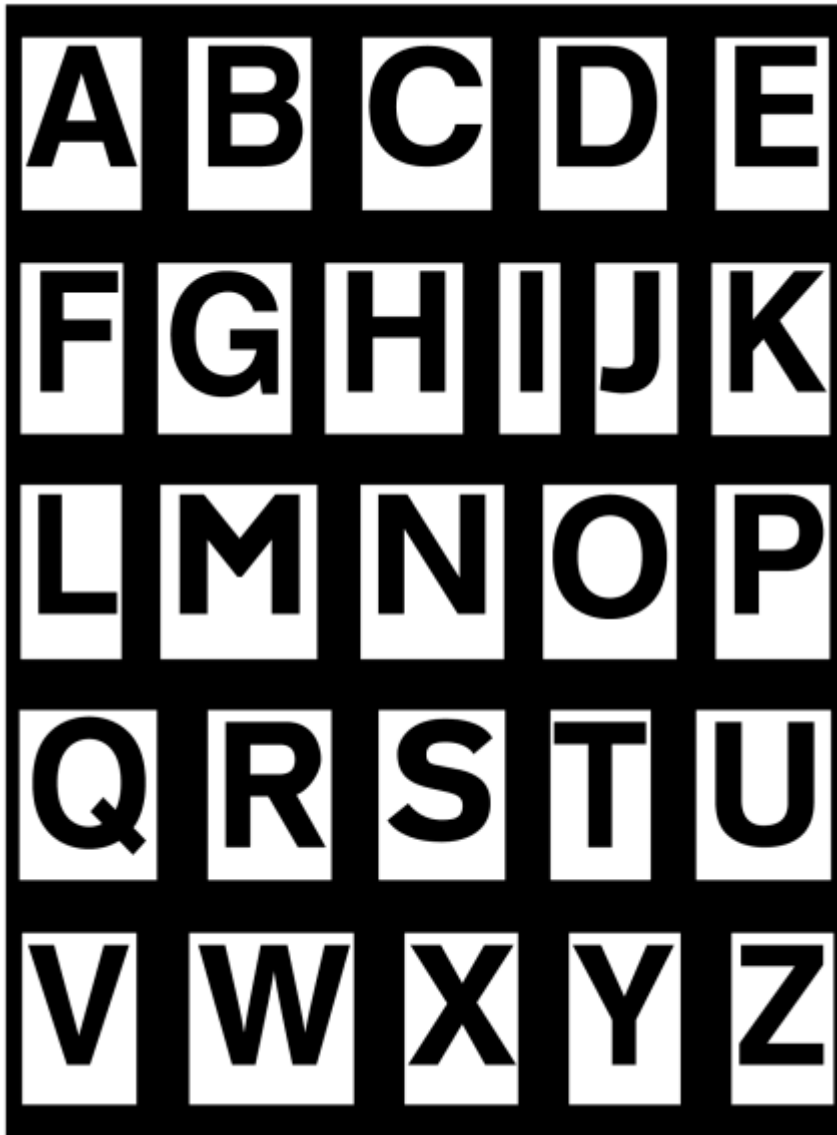

SCHEDULE 26

Regulation 31

Revocations

<i>Title</i>	<i>Year and Number</i>
Road Vehicles Lighting Regulations (Northern Ireland) 1995	S.R. 1995 No. 449

Status: This is the original version (as it was originally made). This item of legislation is currently only available in its original format.

<i>Title</i>	<i>Year and Number</i>
The Road Vehicles Lighting (Amendment) Regulations (Northern Ireland) 1997	S.R. 1997 No. 305

EXPLANATORY NOTE

(This note is not part of the Regulations.)

These Regulations revoke and consolidate with amendments the Road Vehicles Lighting Regulations (Northern Ireland) 1995 and Road Vehicles Lighting (Amendment) Regulations (Northern Ireland) 1997. The amendments are as follows—

Regulation 13 and Schedules 17 and 18 allow vehicles used for police purposes to be fitted with certain markings, namely, yellow or orange retro-reflective material (in addition to red) to the rear of the vehicle and one or more of the colours yellow, blue and white (in addition to amber) to the side of the vehicle.

Regulation 27 and Schedule 23 make provision for vehicles parked no less than 15 metres from any junction of a road to be exempted from the requirement to keep all obligatory lamps lit. Previously this had been 10 metres.

These Regulations have been notified to the European Commission pursuant to European Parliament and Council Directive [98/34/EC](#) of 22nd June 1998 laying down a procedure for the provision of information in the field of technical standards and regulations (O.J. No. L204, 21.7.98, p. 37).

Copies of this Directive can be obtained from The Stationery Office, 16 Arthur Street, Belfast BT1 4GD.