

---

STATUTORY INSTRUMENTS

---

**1994 No. 1519**

**ROAD TRAFFIC**

**The Traffic Signs Regulations and General Directions 1994**

*Made* - - - - - *26th May 1994*  
*Laid before Parliament* *22nd July 1994*  
*Coming into force* - - *12th August 1994*

The Secretary of State for Transport, the Secretary of State for Scotland and the Secretary of State for Wales, acting in the manner and in exercise of the powers specified in Appendix 1 to this Instrument, hereby—

- (a) after consultation with representative organisations in accordance with section 134(2) of the Road Traffic Regulation Act 1984(1) and section 195(2) of the Road Traffic Act 1988(2), make the Regulations set out in Part I, and
- (b) give the Directions set out in Part II, of this Instrument.

**PART I**

**THE TRAFFIC SIGNS REGULATIONS 1994**

*SECTION 1*

*PRELIMINARY*

**Citation and commencement**

- 1. This Part of this Instrument—
  - (a) may be cited—
    - (i) as the Traffic Signs Regulations 1994, and
    - (ii) together with Part II below, as the Traffic Signs Regulations and General Directions 1994; and
  - (b) shall come into force on 12th August 1994.

---

(1) 1984 c. 27.  
(2) 1988 c. 52.

## Revocations

2. The Instruments specified in Appendix 2 to this Instrument, so far as they consist of or comprise regulations, are hereby revoked except that for the purposes of the Traffic Signs (Welsh and English Language Provisions) Regulations 1985(3) the revocations of the Regulations marked with an asterisk in Appendix 2 shall have no effect.

## Savings

3.—(1) Subject to paragraph (2), any traffic sign which immediately before the coming into force of these Regulations is placed on or near any road shall be treated as prescribed by these Regulations, notwithstanding any provisions of these Regulations to the contrary, provided that—

- (a) it is a sign prescribed, or to be treated as if prescribed, by the 1981 Regulations; and
- (b) it continues to comply with those Regulations,

as if those Regulations had not been revoked.

(2) Paragraph (1) shall cease to have effect—

- (a) on 1st January 1996 in relation to any road markings shown in diagrams RM 2 to RM 29 in the Second Schedule to the Traffic Signs Regulations 1957(4), in relation to the sign shown in diagram 623 in Schedule 1 and any road markings shown in diagrams 1005 to 1008, 1013, 1015, 1016, 1027, 1028, 1030, 1031 and 1034 to 1039 in Schedule 2 to the Traffic Signs Regulations 1964(5); and
- (b) on 1st January 1999 in relation to any sign shown in any of the diagrams 508, 509, 537.1, 537.2, 537.3, 537.4, 542.1, 542.2, 554 (when varied to “Ice” or “Snowdrifts”), 556.3, 556.4, 577, 603, 605.1 and 622.1A (when varied to indicate a 16.5 tonne maximum gross weight prohibition) in Schedule 1 and diagrams 1016.1, 1018, 1020 and 1021 in Schedule 2 to the 1981 Regulations; and
- (c) on 1st January 2005 in relation to any sign shown in any of the diagrams 403 to 405, 412A to 418, 422 to 433, 435 to 459, 468 to 472, and 474 to 495 in the First Schedule to the Traffic Signs Regulations 1957, in diagrams 742, 746, 837, and 838 in Schedule 1 to the Traffic Signs Regulations 1964, and in diagrams 626.1, 627, 628.1, 641, 642.1, 653, 734.7, 739.3, 742.1, 742.2, 742.3, 742.4, 742.5, 742.6, 747, 748, 749, 750, 751, 752, 752.1, 753, 753.1, 758, 759, 837.1, 838.1 and 905 in Schedule 1 to the 1981 Regulations; and
- (d) on 1st January 2015 in relation to any sign shown in diagrams 728.1, 728.2, 729, 729.1, 729.2, 729.3, 730, 730.1, 732, 732.1, 732.2, 733, 733.1, 734.1, 734.2, 734.3, 734.4, 734.5, 734.6, 734.8, 734.9, 734.10, 736, 736.1, 737.1, 760 and 761 in Schedule 1 to the 1981 Regulations.

(3) A sign which is of the size, colour and type shown in diagram 701, 702, 702.1, 703, 703.1, 703.2, 703.3, 704, 705, 706, 707, 708, 709, 710, 710.1, 711.1, 712, 712.1, 713, 714, 715, 716, 717, 718, 718.1, 718.2, 718.3, 719, 719.1, 719.2, 719.3A, 719.4, 720, 721.1, 722, 723, 724, 724.1, 724.2, 725, 726, 727, 727.2, 728, 728.1, 728.2, 728.3, 729, 729.1, 729.2, 729.3, 730, 730.1, 732, 732.1, 732.2, 732.4, 732.5, 733, 733.1, 734.1, 734.2, 734.3, 734.4, 734.5, 734.6, 734.7, 734.8, 734.9, 734.10, 735.1, 735.2, 736, 736.1, 737.1, 739, 739.1, 739.2, 739.3, 739.4, 739.5, 741, 741.1 or 905 in Schedule 1 to the 1981 Regulations may be erected on or near a road after the coming into force of these Regulations, notwithstanding that it is not of the size, colour and type shown in any diagram in these Regulations, provided that the design or manufacture of the sign had begun before the coming into force of these Regulations.

---

(3) S.I.1985/713.

(4) S.I. 1957/13, amended by S.I. 1957/149, 1959/761, 1960/1095.

(5) S.I.1964/1857, amended by S.I. 1966/490, 1969/1269, 1970/468, 1970/1972, 1971/2095.

## Interpretation general

### 4. In these Regulations unless the context otherwise requires—

“the 1984 Act” means the Road Traffic Regulation Act 1984;

“the 1988 Act” means the Road Traffic Act 1988;

“the 1981 Regulations” means the Traffic Signs Regulations and General Directions 1981(6);

“articulated vehicle” means a motor vehicle with a trailer so attached to it as to be partially superimposed upon it;

“automatic half-barrier level crossing” means a level crossing where barriers are installed to descend automatically across part of the road when a railway vehicle or tramcar approaches and the operation of the barriers is monitored remotely from the crossing;

“automatic barrier crossing (L)” means a level crossing where barriers are installed to descend automatically across part of the road when a railway vehicle or tramcar approaches and the driver of the railway vehicle or tramcar is required to monitor the operation of the barriers when the railway vehicle or tramcar is at or near the crossing;

“automatic open crossing (L)” means a level crossing without automatic barriers where light signals are so installed as to be operated automatically by a railway vehicle or tramcar approaching the crossing and the driver of the railway vehicle or tramcar is required to monitor the operation of the light signals when the railway vehicle or tramcar is at or near the crossing;

“automatic open crossing (R)” means a level crossing without automatic barriers where light signals are so installed as to be operated automatically by a railway vehicle or tramcar approaching the crossing and the operation of the light signals is monitored remotely from the crossing;

“automatic level crossing” means an automatic half-barrier level crossing, an automatic barrier crossing (L), an automatic open crossing (L) or an automatic open crossing (R);

“central reservation” means—

(a) any land between the carriageways of a road comprising two carriageways; or

(b) any permanent work (other than a traffic island) in the carriageway of a road,

which separates the carriageway or, as the case may be, the part of the carriageway which is to be used by traffic moving in one direction from the carriageway or part of the carriageway which is to be used (whether at all times or at particular times only) by traffic moving in the other direction;

“contra-flow” means a part of a carriageway of a road where—

(a) traffic is authorised to proceed in the opposite direction to the usual direction of traffic on that part; or

(b) a specified class of traffic is authorised to proceed in the opposite direction to other traffic on that carriageway;

“cycle lane” means a part of the carriageway of a road which—

(a) starts with the marking shown in diagram 1009; and

(b) is separated from the rest of the carriageway—

(i) if it may not be used by vehicles other than pedal cycles, by the marking shown in diagram 1049; or

(ii) if it may be used by vehicles other than pedal cycles, by the marking shown in diagram 1004 or 1004.1;

---

(6) S.I. 1981/859, amended by S.I., 1982/1879, 1982/1880, 1983/1086, 1983/1088, 1984/966, 1986/1859, 1987/1706, 1989/2139, 1990/704.

- “dual carriageway road” means a road which comprises a central reservation;
- “enactment” includes any Act or subordinate legislation as defined in section 21(1) of the Interpretation Act 1978(7);
- “excursion or tour” has the meaning given in section 137(1) of the Transport Act 1985(8);
- “goods vehicle” means a motor vehicle or trailer constructed or adapted for use for the carriage or haulage of goods or burden of any description;
- “hours of darkness” means the time between half an hour after sunset and half an hour before sunrise;
- “level crossing” means a place where a road is crossed by a railway or a tramway on a reserved track on the level;
- “local bus” means a public service vehicle used for the provision of a local service not being an excursion or tour;
- “local service” has the meaning given in section 2 of the Transport Act 1985;
- “major road” means the road at a road junction into which there emerges vehicular traffic from a minor road;
- “manually operated” means a change from one sign to another or one signal aspect to another set in process by an operator;
- “maximum gross weight” means—
- (a) in the case of a motor vehicle not drawing a trailer or in the case of a trailer, its maximum laden weight;
  - (b) in the case of an articulated vehicle, its maximum laden weight (if it has one) and otherwise the aggregate maximum laden weight of all the individual vehicles forming part of that articulated vehicle; and
  - (c) in the case of a motor vehicle (other than an articulated vehicle) drawing one or more trailers, the aggregate maximum laden weight of the motor vehicle and the trailer or trailers drawn by it,
- and the foregoing references to the maximum laden weight of a vehicle (including a vehicle which is a trailer) are references—
- (i) in the case of a vehicle as respects which a gross weight not to be exceeded in Great Britain is specified in construction and use requirements (as defined by section 41(8) of the 1988 Act), to the weight so specified, or
  - (ii) in the case of a vehicle as respects which no such weight is so specified, to the weight which the vehicle is designed or adapted not to exceed when in normal use and travelling on a road laden.
- “minor road” means a road on which, at its junction with another road, there is placed the sign shown in diagram 601.1 or 602 or the road marking shown in diagram 1003;
- “mobile road works” means works on a road carried out by or from a vehicle or vehicles which move slowly along the road or which stop briefly from time to time along that road;
- “motorway” means a special road—
- (a) which in England or Wales (save as otherwise provided by or under regulations made under, or having effect as if made under, section 17 of the 1984 Act) can only be used by traffic of Class I or II as specified in Schedule 4 to the Highways Act 1980(9); or

---

(7) 1978 c. 30.

(8) 1985 c. 67.

(9) 1980 c. 66. Schedule 4 was amended by the Road Traffic (Consequential Provisions) Act 1988 (c. 54), Schedule 3, paragraph 21(3).

(b) which in Scotland can only be used by traffic of Class I or Class II as specified in Schedule 3 to the Roads (Scotland) Act 1984<sup>(10)</sup>;

“non-primary route” means a route, not being a primary route or a motorway or part of a primary route or of a motorway;

“passenger vehicle” means a vehicle constructed or adapted for the carriage of passengers and their effects;

“pedal cycle” means a unicycle, bicycle, tricycle, or cycle having four or more wheels, not being in any case mechanically propelled unless it is an electrically assisted pedal cycle of such class as is to be treated as not being a motor vehicle for the purposes of the 1984 Act;

“pedestrian zone” means an area—

(a) which has been laid out to improve amenity for pedestrians; and

(b) to which the entry of vehicles is prohibited or restricted;

“Pelican crossing” means a pedestrian crossing which conforms to The “Pelican” Pedestrian Crossings Regulations and General Directions 1987<sup>(11)</sup>;

“plate” means a sign which by virtue of general directions given in exercise of the power conferred by section 65 of the 1984 Act must always be placed in combination or in conjunction with another sign and which is supplementary to that other sign;

“police vehicle” means a vehicle being used for police purposes or operating under the instructions of a chief officer of police;

“primary route” means a route, not being a route comprising any part of a motorway, in respect of which the Secretary of State—

(a) in the case of a trunk road is of the opinion, and

(b) in any other case after consultation with the traffic authority for the road comprised in the route is of the opinion,

that it provides the most satisfactory route for through traffic between places of traffic importance;

“principal road” means a road for the time being classified as a principal road—

(a) by virtue of section 12 of the Highways Act 1980 (whether as falling within subsection (1) or classified under subsection (3)), or

(b) by the Secretary of State under section 11(1) of the Roads (Scotland) Act 1984;

“public service vehicle” has the meaning given in section 1 of the Public Passenger Vehicles Act 1981<sup>(12)</sup>;

“retroreflecting material” means material which reflects a ray of light back towards the source of that light;

“road maintenance vehicle” means a vehicle which—

(a) in England and Wales is specially designed or adapted for use on a road by or on behalf of a highway authority for the purposes of the Highways Act 1980 for the purposes of road maintenance; or

(b) in Scotland is specially designed or adapted for use on a road by or on behalf of a roads authority for the purposes of the Roads (Scotland) Act 1984<sup>(13)</sup> for the purposes of road maintenance;

---

<sup>(10)</sup> 1984 c. 54.

<sup>(11)</sup> S.I. 1987/16.

<sup>(12)</sup> 1981 c. 14. Section 1 was amended by the Transport Act 1985 (c. 67), Schedule 8.

<sup>(13)</sup> 1984 c. 54.

- “road marking” means a traffic sign consisting of a line or mark or legend on a road;
- “route” includes any road comprised in a route;
- “scheduled express service” means a service provided by a public service vehicle—
- (a) used to carry passengers for hire or reward at separate fares otherwise than in the provision of a local service; and
  - (b) which is operated in accordance with a timetable;
- “school bus” means a vehicle constructed or adapted to carry 12 or more passengers and being used to carry persons to or from a school as defined in section 114(1) of the Education Act 1944<sup>(14)</sup> and, in Scotland, as defined in the Education (Scotland) Act 1980<sup>(15)</sup>;
- “sign” means a traffic sign;
- “stud” means a prefabricated device fixed or embedded as a mark in the carriageway of a road;
- “taxi” means—
- (a) in England and Wales, a vehicle licensed under—
    - (i) section 37 of the Town Police Clauses Act 1847<sup>(16)</sup>; or
    - (ii) section 6 of the Metropolitan Public Carriage Act 1869<sup>(17)</sup>; or under any similar enactment; and
  - (b) in Scotland, a taxi licensed under section 10 of the Civic Government (Scotland) Act 1982<sup>(18)</sup>;
- “taxi rank” means an area of carriageway reserved for use by taxis waiting to pick up passengers;
- “temporary statutory provision” means—
- (a) a provision having effect under section 9 (experimental traffic orders), section 12 (experimental traffic schemes in Greater London) or section 14 (temporary restriction of traffic on roads) of the 1984 Act or under a provision referred to in section 66 (traffic signs for giving effect to local traffic regulations) of that Act;
  - (b) a prohibition, restriction or requirement indicated by a traffic sign placed pursuant to section 67 (emergencies and temporary obstructions) of the 1984 Act; or
  - (c) a provision having effect under section 62 (temporary prohibition or restriction of traffic etc on roads for reasons of safety or public convenience) of the Roads (Scotland) Act 1984;
- “terminal sign” means a sign placed in accordance with direction 8 or 9 of the Traffic Signs General Directions 1994<sup>(19)</sup>;
- “tourist attraction” means a permanently established excursion destination which—
- (a) is recognised by a local authority, the English Tourist Board, the Scottish Tourist Board or the Wales Tourist Board;
  - (b) caters primarily for visitors to the area in which the attraction is located rather than for local residents;
  - (c) is open to the public without prior booking during its normal opening hours; and

---

<sup>(14)</sup> 1944 c. 31.

<sup>(15)</sup> 1980 c. 44 as amended by the Self-Governing Schools etc (Scotland) Act 1989 (1989 c. 39).

<sup>(16)</sup> 1847 c. 89. Section 37 was amended by the Transport Act 1985 (c. 67) section 16(a) and Schedule 8.

<sup>(17)</sup> 1869 c. 115. Section 6 was amended by the Statute Law (Repeals) Act 1976 (c. 16) and by the Transport Act 1981 sections 35(1) and 40(1) and Schedule 12, Part III.

<sup>(18)</sup> 1982 c. 45.

<sup>(19)</sup> Part II of this Instrument.

- (d) does not have retailing or catering as its main purpose;
- “Tourist Information Centre” means a staffed information service centre recognised and supported by the English, Scottish or Wales Tourist Board;
- “Tourist Information Point” means a display of tourist information approved by a regional, area or local tourist board;
- “traffic lane” means, in relation to a road, a part of the carriageway having, as a boundary which separates it from another such part, a road marking of the type shown in diagram 1004, 1004.1, 1005, 1005.1, 1008, 1008.1, 1010, 1013.1, 1013.3, 1040, 1040.2 or 1049;
- “tramcar” has the meaning given in section 141A(4) of the 1984 Act<sup>(20)</sup>;
- “trolley vehicle” has the meaning given in section 141A(4) of the 1984 Act;
- “trunk road” as respects England and Wales has the meaning given in section 329(1) of the Highways Act 1980 and as respects Scotland in section 151(1) of the Roads (Scotland) Act 1984;
- “unladen vehicle” has the meaning given in Schedule 18;
- “variable message sign” has the meaning given in regulation 46(1);
- “with-flow lane” means a traffic lane reserved for a specified class of traffic proceeding in the same direction as general traffic in an adjoining traffic lane; and
- “works bus” means a vehicle constructed or adapted to carry 12 or more passengers (excluding the driver) which has been provided by an employer for the purpose of carrying persons employed by him or on his behalf to or from their place of employment and is being used for that purpose.

### Interpretation of “speed limit”

- 5.—(1) In these Regulations “speed limit” means—
- (a) a maximum or minimum limit of speed on the driving of vehicles on a road—
- (i) imposed by an order under section 14 of the 1984 Act (temporary prohibition or restriction of traffic on roads);
  - (ii) imposed by regulations under section 17 of the 1984 Act (traffic regulation on special roads);
  - (iii) arising by virtue of the road being restricted for the purposes of section 81 of the 1984 Act (general speed limit for restricted roads);
  - (iv) imposed by an order under section 84 of the 1984 Act (speed limits on roads other than restricted roads);
  - (v) imposed by an order under section 88 of the 1984 Act (temporary speed limits); or
  - (vi) imposed by or under a local Act; or
- (b) a maximum limit of speed on the driving of vehicles on a road advised by a traffic authority, and “maximum speed limit” and “minimum speed limit” should be construed accordingly.
- (2) In these Regulations “national speed limit” means any prohibition imposed on a road by the 70 miles per hour, 60 miles per hour and 50 miles per hour (Temporary Speed Limit) Order 1977<sup>(21)</sup> or by regulation 3 of the Motorways (Speed Limit) Regulations 1974<sup>(22)</sup>.

---

<sup>(20)</sup> This section was inserted by section 46 of the Road Traffic Act 1991 (1991 c. 40).

<sup>(21)</sup> This Order is not a Statutory Instrument. It was amended by the 70 miles per hour, 60 miles per hour and 50 miles per hour (Temporary Speed Limit) (Variation) Order 1978 and its provisions were continued in force indefinitely by the 70 miles per hour, 60 miles per hour and 50 miles per hour (Temporary Speed Limit) (Continuation) Order 1978, S.I. 1978/1548.

<sup>(22)</sup> S.I. 1974/502.

## References in the Regulations

6. In these Regulations, unless it is expressly provided otherwise or the context otherwise requires—

- (a) a reference to a numbered regulation is a reference to the regulation so numbered in these Regulations;
- (b) a reference to a numbered paragraph is a reference to the paragraph so numbered in the regulation in which the reference occurs;
- (c) a reference to a sub-paragraph followed by a number or letter is a reference to the sub-paragraph bearing that number or letter in the paragraph in which the reference occurs;
- (d) a reference to a numbered diagram is a reference to the diagram so numbered in a Schedule to these Regulations;
- (e) a reference to a sign or road marking shown in a diagram in a Schedule to these Regulations means a sign or road marking of the size, colour and type shown in that diagram and prescribed by these Regulations and includes a reference to that sign or road marking as varied in accordance with these Regulations;
- (f) a reference to the information, warning, requirement, restriction, prohibition or speed limit conveyed by a sign shown in a diagram includes a reference to that information, warning, requirement, restriction, prohibition or speed limit, however expressed, as varied to accord with any variation of the diagram made in accordance with these Regulations; and
- (g) in any provision which includes a table, references to a table or to a numbered table are to the table or as the case may be to the table so numbered in that provision.

## Interpretation of Schedules 1 to 12

7.—(1) In any untitled table under or beside any diagram (in this paragraph referred to as “the diagram”) in Schedules 1 to 12—

- (a) in item 1 any regulations which are specified are regulations in these Regulations in which a specific reference is made to the diagram;
- (b) in item 2 any directions which are specified are directions in the Traffic Signs General Directions 1994(23) in which a specific reference is made to the diagram;
- (c) in item 3 any diagrams which are specified are diagrams in the Schedules to these Regulations which show signs which may or must be placed in conjunction or in combination with the sign shown in the diagram;
- (d) in item 4 any item which is specified is an item in Schedule 16 which specifies permitted variants to the diagram; and
- (e) in item 5 any item which is specified is an item in Schedule 17 which specifies the illumination requirements for the sign shown in the diagram.

(2) The table entitled “Table of combinations” under or beside any diagram in Part III of Schedule 12 indicates the manner in which the sign shown in that diagram may be varied in accordance with paragraphs (6) to (8) of regulation 17.

(3) Dimensions indicated on any diagram shown in Schedules 1 to 12 are expressed in millimetres unless otherwise specified.



*SECTION 2*  
*GENERAL PROVISIONS*

**Authorisations by the Secretary of State**

**8.** Nothing in these Regulations shall be taken to limit the powers of the Secretary of State under section 64 of the 1984 Act to authorise the erection or retention of traffic signs of a character not prescribed by these Regulations.

**Temporary obstructions**

**9.** Nothing in these Regulations shall have effect so as to authorise any persons not otherwise authorised to do so to place on or near a road any object or device for warning traffic of a temporary obstruction.

**Application of section 36 of the Road Traffic Act 1988 to signs and disqualification for offences**

**10.**—(1) Section 36 of the 1988 Act shall apply to—

- (a) the signs shown in any of the diagrams 601.1, 602, 606, 610, 611.1, 614, 616, 626.2, 629.2, 629.2A, 784, 953, 953.1 and 7023 and to the sign shown in diagram 602 when placed in combination with that shown in diagram 778 or 778.1;
- (b) the red light signal when displayed by the light signals prescribed by regulation 30 or by regulation 32;
- (c) the road markings shown in diagram 1013.1 or 1013.3 insofar as those markings convey the requirements specified in regulation 26;
- (d) the road marking shown in diagram 1003 insofar as that marking conveys the requirements specified in regulation 25;
- (e) the road markings shown in diagrams 1043, 1044 and 1045;
- (f) the light signals prescribed by regulation 30(2) as varied in accordance with regulation 31 when they are displaying the green arrow signals shown in diagrams 3000.4, 3000.6, 3002, 3003, 3004, 3005, 3006, 3007, 3008, 3009.1, 3011.1 and 3011.2 insofar as they convey the restrictions specified in paragraphs (1)(f) and (1)(g) of regulation 33; and
- (g) the light signal shown in diagram 3013.1.

(2) The signs hereby specified for the purposes of column 5 of the entry in Schedule 2 to the Road Traffic Offenders Act 1988(24) relating to offences under section 36 of the 1988 Act are:—

- (a) the signs shown in diagrams 601.1 and 616;
- (b) the signs shown in diagrams 629.2 and 629.2A;
- (c) the sign shown in diagram 784;
- (d) the red light signal when displayed by the light signals prescribed by regulation 30 or by regulation 32;
- (e) the road markings shown in diagram 1013.1 or 1013.3 insofar as those markings convey the requirements specified in regulation 26(2); and
- (f) the light signals prescribed by regulation 30(2) when they are displaying the green arrow signals shown in diagrams 3000.4, 3000.6, 3002, 3003, 3004, 3005, 3006, 3007, 3008,

3009.1, 3011.1 and 3011.2 insofar as they convey the restrictions specified in paragraphs (1)(f) and (1)(g) of regulation 33.

### **Signs, markings and signals to be of the sizes, colours and types shown in the diagrams**

**11.**—(1) Subject to the provisions of these Regulations, a sign for conveying information or a warning, requirement, restriction, prohibition or speed limit of the description specified under a diagram in Schedules 1 to 7, Part II of Schedule 10 and Schedule 12 to traffic on roads shall be of the size, colour and type shown in the diagram.

(2) The signs shown in diagrams 515.1, 515.1A, 515.2, 1012.2, 1012.3, 1049.1 and 7102 shall be of the size, colour and type shown in the two parts of those diagrams.

(3) In Schedule 6, a road marking shown in a diagram as a horizontal line shall be laid transversely, and a marking shown as a vertical line shall be laid longitudinally, to the flow of traffic, except so far as the nature of the diagram or the caption to the diagram indicates that it may or should be laid in another direction.

(4) The road marking shown in diagram 1055 shall be white, silver or light grey in colour.

### **Variations of dimensions**

**12.**—(1) Where any diagram in Schedules 1 to 12 specifies a dimension for an element of a sign together with a dimension for that element in brackets, the dimensions so specified shall, subject to paragraph (2), be alternatives.

(2) Subject to paragraphs (3) and (4), where alternative dimensions are specified for more than one element of a sign, the dimensions chosen for each element must correspond with one another so that the shape and proportions of the sign are as shown in the diagram.

(3) Paragraph (2) does not apply to the road marking shown in diagram 1009 and the respective lengths of the lines comprised in that sign and of the gaps between them may be either—

(a) 600 and 300 millimetres, in which case the width of the lines may be 100, 150 or 200 millimetres; or

(b) 300 and 150 millimetres, in which case the width of the lines shall be 100 millimetres.

(4) Paragraph (2) does not apply to the road markings shown in diagrams 1013.3, 1035, 1036.1, 1036.2, 1037.1, 1040, 1040.2, 1040.4 and 1041.

(5) Where any diagram in Schedules 1 to 12 specifies a maximum and a minimum dimension for an element of a sign, the dimension chosen for that element shall, subject to the footnote to Table 1, be not more than the maximum and not less than the minimum.

(6) Where maximum and minimum dimensions are specified for more than one element of a sign, the dimensions chosen for each element must correspond with one another so that the shape and proportions of the sign are as shown in the diagram.

(7) Where a sign shown in diagram 606, 607, 609, 610, 611, 611.1, 612, 613, 614, 616, 636, 638, 642, 643, 644 or 645 is placed temporarily on a road by a constable or a person acting under the instructions (whether general or specific) of the chief officer of police for the purposes of indicating a temporary statutory provision, any dimension in the diagram for the diameter of a roundel, or for the sign may be reduced so long as any dimension shown in the diagram for the diameter of a roundel or for the measurement horizontally of the sign is at least 200 millimetres, and the height of any lettering is at least 20 millimetres.

(8) Any sign shown in diagrams 960, 960.1, 7201, 7202, 7203, 7203.1, 7204, 7205, 7206, 7207, 7210, 7211, 7212, 7213, 7214, 7215, 7216, 7217, 7218, 7220, 7221, 7230, 7231, 7232, 7233, 7234, 7235, 7236, 7237, 7238, 7239, 7240, 7250, 7251, 7252, 7253, 7254, 7255, 7256 or in a diagram in Schedule 7 (other than diagrams 2032, 2130, 2208, 2708, 2711, 2712, 2713, 2714, 2715, 2922, 2923

and 2932) shall be of such dimensions as, having regard to the character of the road and the speed of the vehicular traffic generally using it, are necessary to accommodate any place name, route symbol or number, arrow, indication of distance, symbol or any other indication which, in accordance with these Regulations, may be shown on the sign and which it is appropriate to show for the purpose for which that sign is placed on the road.

(9) Any sign shown in a diagram in Part III of Schedule 12 shall be of such dimensions as, having regard to the character of the road and the speed of traffic generally using it, are necessary to accommodate the route symbols or arrows appropriate to the number of traffic lanes and the nature of the road works in relation to which the sign is placed.

(10) Any dimension (not being an angle or specified as a maximum or minimum) specified in these Regulations shall be treated as permitted by these Regulations if it is varied in accordance with the following Tables, subject, in the case of Tables 1 and 2, to the Notes to those Tables.

**Table 1**

**Diagrams in Schedules 1 to 5, 7, 10 and 12 Height of letters or numbers**

(1) <i>Item</i>	(2) <i>Dimensions shown in diagrams</i>	(3) <i>Permitted variations</i>
1.	100 millimetres or more	Up to 5% of the dimension
2.	Less than 100 millimetres	Up to 7.5% of the dimension

NOTE: Where the height of letters or numbers is expressed as a range within maximum and minimum dimensions the permitted variations indicated in this Table shall apply to those dimensions shown as the maximum and minimum.

**Table 2**

**Diagrams in Schedule 6 All dimensions**

(1) <i>Item</i>	(2) <i>Dimensions shown in diagrams</i>	(3) <i>Permitted variations</i>
1.	3 metres or more	(i) Up to 15% of the dimension where the varied dimension is greater than the specified dimension; or (ii) Up to 10% of the dimension where the varied dimension is less than the specified dimension.
2.	300 millimetres or more, but less than 3 metres	(i) Up to 20% of the dimension where the varied dimension is greater than the specified dimension; or

NOTE: Where a dimension denoting the length or width of a road marking is varied in accordance with this Table, and there is a space between two parts of the marking, the dimensions of that space may be varied as required to accommodate the variation of the length or width of the marking, provided that the character of the marking is maintained.

*Status: This is the original version (as it was originally made). This item of legislation is currently only available in its original format.*

(1) <i>Item</i>	(2) <i>Dimensions shown in diagrams</i>	(3) <i>Permitted variations</i>
3.	10 millimetres or more but less than 300 millimetres	(ii) Up to 10% of the dimension where the varied dimension is less than the specified dimension.  (i) Up to 30% of the dimension where the varied dimension is greater than the specified dimension; or  (ii) Up to 10% of the dimension where the varied dimension is less than the specified dimension.
4.	Less than 10 millimetres	(i) Up to 2 millimetres more than the dimension where the varied dimension is greater than the specified dimension; or  (ii) Up to 1 millimetre less than the dimension where the varied dimension is less than the specified dimension.

NOTE: Where a dimension denoting the length or width of a road marking is varied in accordance with this Table, and there is a space between two parts of the marking, the dimensions of that space may be varied as required to accommodate the variation of the length or width of the marking, provided that the character of the marking is maintained.

**Table 3**

**All dimensions other than those in Tables 1 and 2**

(1) <i>Item</i>	(2) <i>Dimensions shown in diagrams</i>	(3) <i>Permitted variations</i>
1.	300 millimetres or more	Up to 5% of the dimension
2.	50 millimetres or more, but less than 300 millimetres	Up to 7.5% of the dimension
3.	Less than 50 millimetres	Up to 10% of the dimension

(11) Any variation of any angle specified in any diagram in Schedule 1, 6 or 8, except diagrams 1043 and 1044, shall be treated as permitted by these Regulations if the variation does not exceed 5 degrees.

(12) Where—

- (a) overall dimensions are given for a sign shown in any diagram in the Schedules to these Regulations; and
- (b) the legend on that sign is varied in accordance with regulation 17 and with item 4 of the table appearing under or beside that diagram,

the overall dimensions or the number of lines filled by the legend, or both, may be varied so far as necessary to give effect to the variation of the legend.

### **Proportions and form of letters, numerals, symbols and other characters**

#### **13.—(1) Subject to paragraphs (2), (3) and (5)**

- (a) all letters, numerals and other characters incorporated in the signs or parts of the signs shown in the diagrams in Schedules 1 to 5, 7, 10 and 12 which have a red, blue, brown, black or green background (other than those incorporated in the bottom panel of diagram 674, diagrams 973, 973.1, 2401, 2402, 2403, 2607, 2610, 2610.1, 2610.2, the top panels of diagrams 2919 and 2920, the petrol price display in diagram 2919, and diagrams 5001.1, 5001.2, 5003, 5003.1, 5005 and 5005.1, the top and bottom panels of diagram 7008 and the words “National Trust for Scotland” used in conjunction with the symbol shown in diagram T303 in Part IV of Schedule 14) and the signs shown in diagrams 2714 and 2715 shall have the proportions and form shown in Part I of Schedule 13; and
- (b) all letters, numerals and other characters incorporated in the signs or the parts of signs shown in the diagrams in Schedules 1 to 5, 7, 10 and 12 which have a white, yellow or orange background (other than those incorporated in the bottom panel of diagram 674, diagrams 973, 973.1, 2401, 2402, 2403, 2610, 2610.1, 2610.2, 2714, 2715, the top panels of diagrams 2919 and 2920, and the top and bottom panels of diagram 7008) shall have the proportions and form shown in Part II of Schedule 13.

(2) Letters and numerals used for the purpose of indicating a route number on any sign shown in a diagram in Part X of Schedule 7 (other than those incorporated in diagram 2913 and 2914) shall have the proportions and form shown in Part III of Schedule 13, except where a route number is indicated in brackets on a sign shown in diagram 2904, 2904.1, 2906, 2908 or 2909 in which case those letters and numerals shall have the proportions and form shown in either Part I or Part III of Schedule 13 as appropriate.

(3) Letters and numerals used for the purpose of indicating a route number on any sign shown in a diagram in Part III of Schedule 12 when used on a motorway shall have the proportions and form shown in Part IV of Schedule 13.

(4) Subject to and within the limits of any dimension specified as a maximum or minimum in diagrams 973, 973.1, 2401, 2402, 2403, 2607, 2610, 2610.1, 2610.2, the top panels of diagrams 2919 and 2920, the petrol price display in diagram 2919, and the top and bottom panels of diagram 7008 any letters or numerals or other characters incorporated in those diagrams may have proportions and form other than the proportions and form shown in Schedule 13.

(5) All letters, numerals, symbols and other characters incorporated in variable message signs shall have the general proportions and form shown in Part V of Schedule 13 where the construction or method of operation of the sign does not permit the use of letters, numerals and other characters of the proportions and form shown in Part I, II, III or IV of Schedule 13 or of symbols shown in diagrams in Schedules 1 to 5, 10 or 12.

(6) All letters, numerals and other characters incorporated in the road markings shown in the diagrams in Schedule 6 shall have the proportions and form shown in Part VI of Schedule 13.

(7) Symbols incorporated in signs for the purpose of indicating diversion routes to be followed in an emergency shall have the proportions and form shown in Part VII of Schedule 13.

(8) Symbols incorporated in signs for the purpose of indicating the type of a tourist attraction shall have the proportions and form shown in Schedule 14.

### Signs attached to vehicles

**14.**—(1) A sign attached to a vehicle of the description and in the position on that vehicle specified in an item in column (2) of the Table, when the vehicle is on a road which is subject to a maximum speed limit specified in column (3) of that item, shall be of the size, colour and type shown in one of the diagrams specified in column (4) of that item.

**Table**

(1) <i>Item</i>	(2) <i>Description of vehicle, and position</i>	(3) <i>Maximum speed limit</i>	(4) <i>Diagram numbers</i>
1.	Road maintenance vehicle, on the front	30 mph or under	610, 7001 and 7001.1
2.	Road maintenance vehicle, on the rear	30 mph or under	610, 7001, 7001.1, 7401, 7401.1, 7402, 7403 and 7404
3.	Road maintenance vehicle, on the rear	More than 30 mph	7401, 7401.1, 7402, 7403 and 7404
4.	Police vehicle, on the front or the rear	70 mph or under	829.1, 829.2, 829.3 and 829.4

(2) The operating requirements for the lamps that form part of the signs shown in diagrams 7401, 7402 and 7403 are that—

- (a) the lamps shall be illuminated only when the signs are being used in accordance with the Table; and
- (b) each lamp shall show an intermittent amber light at a rate of flashing of not less than 60 nor more than 90 flashes per minute, and in such a manner that the lights of one horizontal pair are always shown when the lights of the other horizontal pair are not shown.

### SECTION 3

#### WARNING, REGULATORY AND INFORMATORY TRAFFIC SIGNS

### Sign shown in diagram 610 and its significance

**15.**—(1) Except as provided in paragraphs (2) and (3), the requirement conveyed by the sign shown in diagram 610 shall be that vehicular traffic passing the sign must keep to the left of the sign where the arrow is pointed downwards to the left, or to the right of the sign where the arrow is pointed downwards to the right.

(2) On an occasion where a vehicle is being used for fire brigade, ambulance or police purposes and the observance of the requirement specified in paragraph (1) would be likely to hinder the use of that vehicle for one of those purposes then, instead of that requirement, the requirement conveyed by the sign in question shall be that the vehicle shall not proceed beyond that sign in such a manner or at such a time as to be likely to endanger any person.

(3) The requirement specified in paragraph (1) does not apply to a tramcar or trolley vehicle.

**Signs shown in diagrams 601.1, 602, 778, 778.1 and 784 and their significance**

16.—(1) The requirements conveyed to vehicular traffic on roads by a sign shown in the diagram specified in column (2) of an item in the Table are specified in column (3) of that item.

**Table**

(1) <i>Item</i>	(2) <i>Diagram number</i>	(3) <i>Requirements</i>
1.	601.1	(a) (a) Every vehicle shall stop before crossing the transverse line shown in diagram 1002.1 or, if that line is not clearly visible, before entering the major road in respect of which the sign shown in diagram 601.1 has been provided; and (b) no vehicle shall cross the transverse line shown in diagram 1002.1 or, if that line is not clearly visible, enter the major road in respect of which the sign shown in diagram 601.1 has been provided, so as to be likely to endanger the driver of or any passenger in any other vehicle or to cause that driver to change the speed or course of his vehicle in order to avoid an accident.
2.	602	No vehicle shall cross the transverse line shown in diagram 1003 nearer to the major road at the side of which that line is placed, or if that line is not clearly visible, enter that major road, so as to be likely to endanger the driver of or any passenger in any other vehicle or to cause that driver to change the speed or course

---

*Status: This is the original version (as it was originally made). This item of legislation is currently only available in its original format.*

---

(1) <i>Item</i>	(2) <i>Diagram number</i>	(3) <i>Requirements</i>
3.	602 when placed in combination with 778 or 778.1	<p>of his vehicle in order to avoid an accident.</p> <p>No vehicle shall cross the transverse line shown in diagram 1003 nearer to the level crossing at the side of which that line is placed, or if that line is not clearly visible, enter that level crossing, so as to be likely to endanger the driver of or any passenger in any railway vehicle or tramcar or to cause that driver to change the speed of his vehicle in order to avoid an accident.</p>
4.	784	<p>No abnormal transport unit shall proceed onto or over an automatic half-barrier level crossing or an automatic open crossing (R) unless—</p> <p>(a) the driver of the unit has used a telephone provided at or near the crossing for the purpose of obtaining from a person, authorised in that behalf by the railway or tramway authority, permission for the unit to proceed;</p> <p>(b) that permission has been obtained before the unit proceeds; and</p> <p>(c) the unit proceeds in accordance with any terms attached to that permission.</p> <p>Provided that sub-paragraphs (b) and (c) above shall not apply if—</p> <p>(i) on the use by the driver of the telephone placed at or near the crossing he receives an indication for not less than two minutes that the telephone at the other end of the telephone line is being called, but no duly</p>



(1) <i>Item</i>	(2) <i>Diagram number</i>	(3) <i>Requirements</i>
		authorised person answers it, or he receives no indication at all due to a fault or malfunction of the telephone; and (ii) the driver then drives the unit on to the crossing with the reasonable expectation of crossing it within times specified in a railway or tramway notice at that telephone as being times between which railway vehicles or trams do not normally travel over that crossing.

(2) In this regulation—

“abnormal transport unit” means—

- (a) a motor vehicle or a vehicle combination
  - (i) the overall length of which, inclusive of the load (if any) on the vehicle or the combination, exceeds 55 feet; or
  - (ii) the overall width of which, inclusive of the load (if any) on the vehicle or the combination, exceeds 9 feet 6 inches; or
  - (iii) the maximum gross weight of which exceeds 38 tonnes; or
- (b) a motor vehicle, or a vehicle combination, which in either case is incapable of proceeding, or is unlikely to proceed, over an automatic railway level crossing at a speed exceeding 5 miles per hour;

“driver” in relation to an abnormal transport unit, means where that unit is a single motor vehicle the driver of that vehicle and, where that unit is a vehicle combination, the driver of the only or the foremost motor vehicle forming part of that combination; and

“vehicle combination” means a combination of vehicles made up of one or more motor vehicles and one or more trailers all of which are linked together when travelling.

### Permitted variants

17.—(1) Where the circumstances in which a sign shown in a diagram in a Schedule (other than Schedule 6) to these Regulations is to be placed so require or where appropriate in those circumstances, the form of the sign shall or may be varied—

- (a) in the manner (if any) allowed or required in item 4 of the untitled table below or beside the diagram; or
- (b) in the manner allowed or required in column (3) of an item in Schedule 16, if the diagram is one whose number is given in column (2) of that item.

(2) A symbol in the form of a prescribed sign to which direction 7 of the Traffic Signs General Directions 1994 applies shall not be incorporated in a sign in accordance with item 31 of Schedule 16, except in circumstances where it could be placed as a sign in accordance with that direction.

(3) A symbol incorporated as mentioned in paragraph (2) shall or may be varied in the same manner as the sign which the symbol represents or from which it is derived.

(4) In each of the signs shown in diagrams 780, 780.1 and 780.2 the safe height shown on the sign shall be varied where necessary so that it is between 1 ½ and 2 feet (450 to 600 millimetres) less than the height of the lowest part of the overhead wire, of which the sign gives warning, over the highest part of the surface of the carriageway beneath that wire.

(5) Where a sign shown in a diagram in Schedule 7 indicates a road or a route, and that road or route is temporarily closed, there may be affixed to the sign or to that part of the sign where that road or route is indicated, in order to cancel temporarily the indication, a board coloured red and displaying in white lettering the words “Road temporarily closed” or “Route temporarily closed”.

(6) In this paragraph and paragraphs (7) and (8)—

- (a) “combination sign” means a sign shown in diagram 7201, 7210, 7211, 7212, 7213, 7214, 7215, 7216, 7217, 7218, 7220, 7221, 7230, 7231, 7232, 7233, 7234, 7235, 7236, 7237, 7238, 7239 or 7240;
- (b) “panel” means a sign shown in diagram 7260, 7261, 7262, 7263, 7264, 7270, 7271, 7272, 7273, 7274 or 7275 when used as part of a combination sign and references to a panel whose number is shown in a Table of combinations are to a sign shown in a diagram having a number so shown;
- (c) “permitted combination” means one of the combinations specified in paragraph (8);
- (d) “the table” in relation to a combination sign means the Table of combinations appearing below or beside the diagram in which that sign is shown;
- (e) “top panel” means a panel shown at the top of a combination sign and “bottom panel” means a panel shown at the bottom of such a sign.

(7) If and only if the top and bottom panels of the sign as varied together constitute a permitted combination, a combination sign may be varied in the following ways—

- (a) by substituting for the top panel or, where a top panel is not shown, by adding as a top panel, a panel whose number is shown in item (1) of the table;
- (b) by substituting for the bottom panel or, where a bottom panel is not shown by adding as a bottom panel, a panel whose number is shown in item (2) of the table;
- (c) if the word “none” appears in item (1) of the table, by omitting the top panel;
- (d) if the word “none” appears in item (2) of the table, by omitting the bottom panel.

(8) Each of the following is a permitted combination—

- (a) a top panel whose number appears in item (1) of a column in the table and a bottom panel whose number appears in item (2) of the same column;
- (b) a top panel whose number appears in item (1) of a column in the table and, if the word “none” appears in item (2) of the same column, no bottom panel;
- (c) a bottom panel whose number appears in item (2) of a column in the table and, if the word “none” appears in item (1) of the same column, no top panel;
- (d) if the word “none” appears in both items of the same column of the table, no top panel and no bottom panel.

(9) Where the form of a sign is varied in accordance with these Regulations, the information, warning, requirement, restriction, prohibition or speed limit conveyed to traffic by the sign is varied to accord with the form of the sign as varied.

### **Illumination of signs**

**18.**—(1) Subject to paragraph (2), every sign shown in a diagram whose number is indicated in column (2) of an item in Schedule 17 shall be illuminated in the manner and at the times described in column (3) of that item.

(2) Where a sign shown in a diagram whose number is indicated in column (2) of an item in Schedule 17 is placed for the purpose of conveying to vehicular traffic a warning, information, prohibition, restriction or requirement which applies only at certain times, the sign shall be illuminated in accordance with that Schedule only during those times.

(3) Where a sign shown in a diagram whose number is indicated in column (2) of an item in Schedule 17 is illuminated by means of external lighting, then that means of lighting shall be fitted to—

- (a) the sign; or
- (b) the structure on which the sign is mounted or which is otherwise specially provided,

except that if a sign is mounted on a bridge, tunnel or similar structure over a road the means of lighting may alternatively be mounted separately in a manner such as to illuminate the face of the sign effectively.

**19.**—(1) Nothing in this regulation shall apply to the signs shown in diagrams 560, 561, 776, 781, 5001.1, 5001.2, 5003, 5003.1, 5005 and 5005.1.

(2) Subject to the provisions of regulation 18 and paragraph (1), any sign shown in a diagram in Schedules 1 to 5, 7, 10 and 12—

- (a) when placed as part of a road works scheme must, and
- (b) in other situations may,

be illuminated by the use of retroreflecting material in accordance with the following provisions of this regulation.

(3) Subject to paragraph (4), where retroreflecting material is used on any part of a sign shown in a diagram, all other parts of that sign shall also be illuminated by means of retroreflecting material.

(4) No retroreflecting material shall be applied to—

- (a) any part of a sign coloured black;
- (b) that part of the sign shown in diagram 605.2 which is coloured fluorescent yellow, unless the retroreflecting material is applied to that part in horizontal strips with a gap between each strip, or unless the retroreflecting material is itself also fluorescent;
- (c) that part of a sign shown in diagram 2714 or 2715 which is coloured orange,

and in this paragraph the word “part”, in relation to a sign, means any part of that sign which is uniformly coloured and bounded by parts of a different colour.

### **Illumination of plates**

**20.**—(1) Where a plate is placed in combination with a sign shown in a diagram in Schedules 1 to 5 or 12, and that sign is illuminated in accordance with regulation 18, the plate shall, subject to paragraph (2), be illuminated by the same means as the sign.

(2) Paragraph (1) shall not apply where the means of lighting provided for the illumination of the sign adequately illuminates the plate.

### **Illumination of signs shown in diagrams 560 and 561**

21.—(1) The signs shown in diagrams 560 and 561 shall not be illuminated by the fitting of a means of internal or external lighting.

(2) A sign shown in a diagram whose number appears in column (2) of an item in the Table and having the dimension specified in column (3) of that item shall be illuminated by either of the methods prescribed in paragraph (3) which are shown in column (4) of the item, and by no other method.

**Table**

(1) <i>Item</i>	(2) <i>Diagram number</i>	(3) <i>Dimension</i>	(4) <i>Method of illumination</i>
1.	560	150 millimetres diameter	Paragraph 3(a) or (b)
2.	560	75 millimetres or more but less than 150 millimetres diameter	Paragraph 3(c) or (d)
3.	561	180 square centimetres area	Paragraph 3(b) or (e)

(3) The prescribed methods of illumination are—

- (a) the use of 14 circular reflectors of the corner cube type, each reflector having a diameter of 22 millimetres;
- (b) the use of retroreflecting material extending over the whole surface of the sign;
- (c) the use of a single circular reflector of the corner cube type extending over the whole surface of the sign;
- (d) the use of reflectors consisting of bi-convex lenses extending over the whole surface of the sign; and
- (e) the use of a single rectangular reflector of the corner cube type extending over the whole surface of the sign.

### **Buses and coaches**

22.—(1) In the signs shown in the permitted variants of diagrams 618.1, 618.2, 618.3, 618.3A, 620 and 820, in diagrams 877, 954, 954.1, 954.2, 954.3, 970, 973, 973.1, 974, 975, 1025, 1025.1, 1025.2 and 1025.3 and in the permitted variant of diagram 1028.2 the expressions “bus”, “buses” and “buses and coaches” have the meanings given in paragraphs (2) and (3).

(2) “Buses” in the signs referred to in paragraph (1) means—

- (a) before 1st January 1997—
  - (i) public service vehicles used for the provision of local services or scheduled express services;
  - (ii) school buses; or
  - (iii) works buses; and
- (b) after 31st December 1996—

(i) motor vehicles constructed or adapted to carry more than 8 passengers (exclusive of the driver); and

(ii) local buses not so constructed or adapted;

and “bus” shall be construed accordingly.

(3) The expression “buses and coaches” referred to in paragraph (1) means until 31st December 1996 vehicles constructed or adapted to carry 12 or more passengers (exclusive of the driver).

### **Bus lanes**

**23.**—(1) In the sign shown in diagram 962, 962.2, 963, 963.2, 964, 1048 or 1048.1 the expression “bus lane” has the meaning given in paragraphs (2) and (3).

(2) Before 1st January 1997 “bus lane” in the signs referred to in paragraph (1) means a traffic lane reserved for—

- (a) public service vehicles used in the provision of local services or scheduled express services;
- (b) school buses;
- (c) works buses; and
- (d) pedal cycles and taxis where indicated on the sign shown in diagram 958 or 959 and pedal cycles where indicated on the sign shown in diagram 960, 962.2, 963.2 or 1048.1.

(3) After 31st December 1996 “bus lane” in the signs referred to in paragraph (1) means a traffic lane reserved for—

- (a) motor vehicles constructed or adapted to carry more than 8 passengers (exclusive of the driver);
- (b) local buses not so constructed or adapted; and
- (c) pedal cycles and taxis where indicated on the sign shown in diagram 958 or 959 and pedal cycles where indicated on the sign shown in diagram 960, 962.2, 963.2 or 1048.1.

### **Bus symbols**

**24.**—(1) Before 1st January 1997 the symbol representing a bus (“the bus symbol”) in the sign or the permitted variant of the sign shown in a diagram whose number is indicated in column (2) of an item in the Table refers to the vehicles indicated in column (3) of that item.

**Table**

(1) <i>Item</i>	(2) <i>Diagram number</i>	(3) <i>Vehicles</i>
1.	952	All motor vehicles constructed or adapted to carry more than 12 passengers (exclusive of the driver), except— <ul style="list-style-type: none"> <li>(a) public service vehicles used in the provision of local services;</li> <li>(b) scheduled express services;</li> <li>(c) school buses; or</li> <li>(d) works buses.</li> </ul>

*Status: This is the original version (as it was originally made). This item of legislation is currently only available in its original format.*

(1) <i>Item</i>	(2) <i>Diagram number</i>	(3) <i>Vehicles</i>
2.	953, the permitted variant of 953.1 with the bus symbol, the permitted variants of 958 and 959 without the legend “local”, 960, 962, 962.2, 963, 963.2 and 970	(a) (a) Public service vehicles used in the provision of local services; (b) scheduled express services; (c) school buses; or (d) works buses.
3.	(a) (a) The permitted variants of 640.2A, 665 and 666 with the bus symbol; (b) 969 and 2106; (c) the permitted variants of 958 and 959 with the legend “& coaches” placed on the symbol; and (d) the permitted variants of diagrams 832.3, 832.4, 832.5, 832.6 and 832.7	All motor vehicles constructed or adapted to carry 12 or more passengers (exclusive of the driver).
4.	972	Public service vehicles used in the provision of excursions or tours.

(2) After 31st December 1996 the bus symbol when incorporated into any sign refers to—

- (a) motor vehicles constructed or adapted to carry more than 8 passengers (exclusive of the driver); or
- (b) local buses not so constructed or adapted.

(3) In the signs shown in diagrams 953, the permitted variant of 953.1, 958, 959 and 960 the word “local” on the bus symbol indicates that the road or the traffic lane on or near which the sign has been placed shall be used only by local buses.

#### SECTION 4

#### ROAD MARKINGS

#### Road marking shown in diagram 1003 and its significance

25.—(1) The requirements conveyed to vehicular traffic on roads by the road marking shown in diagram 1003 shall be as follows.

(2) Except as provided by paragraphs (3) and (4), the requirement conveyed by the transverse lines shown in diagram 1003, whether or not they are placed in conjunction with the sign shown in diagram 602 or 1023, shall be that no vehicle shall proceed past such one of those lines as is nearer the major road into that road in a manner or at a time likely to endanger the driver of or any

passenger in a vehicle on the major road or to cause the driver of such a vehicle to change its speed or course in order to avoid an accident.

(3) Wherever the transverse lines are placed in conjunction with the sign shown in diagram 602, and that sign is at the same time placed in combination with the sign shown in diagram 778 or 778.1 at a level crossing, then the requirement shall be that no vehicle shall proceed past such one of those lines as is nearer the level crossing in a manner or at a time likely to endanger the driver of or any passenger in a railway vehicle or tramcar, or to cause that driver to change the speed of his vehicle in order to avoid an accident.

(4) Wherever the transverse lines are placed in advance of a point in the road where the width of the carriageway narrows significantly, then the requirement shall be that no vehicle shall proceed past such one of these lines as is nearer to the point of narrowing in a manner or at a time likely to endanger the driver of or any passenger in a vehicle that is proceeding in the opposite direction to the first-mentioned vehicle, or to necessitate the driver of such a vehicle to change its speed or course in order to avoid an accident.

### **Road markings shown in diagrams 1013.1 and 1013.3 and their significance**

**26.**—(1) A road marking for conveying the requirements specified in paragraph (2) and the warning specified in paragraph (5) shall be of the size, colour and type shown in diagram 1013.1 or 1013.3.

(2) The requirements conveyed by the road marking mentioned in paragraph (1) shall be that—

- (a) subject to paragraph (3), no vehicle shall stop on any length of road along which the marking has been placed at any point between the ends of the marking; and
- (b) subject to paragraph (4), every vehicle proceeding on any length of road along which the marking has been so placed that, as viewed in the direction of travel of the vehicle, a continuous line is on the left of a broken line or of another continuous line, shall be so driven as to keep the first-mentioned continuous line on the right hand or off side of the vehicle.

(3) Nothing in paragraph (2)(a) shall apply—

(a) so as to prevent a vehicle stopping on any length of road so long as may be necessary for any of the following purposes—

- (i) to enable a person to board or alight from the vehicle,
- (ii) to enable goods to be loaded on to or to be unloaded from the vehicle,
- (iii) to enable the vehicle to be used in connection with—

- (a) any building operation or demolition;
- (b) the removal of any obstruction to traffic;
- (c) the maintenance, improvement or reconstruction of that length of road; or
- (d) the laying, erection, alteration or repair in or near that length of road of any sewer or of any main, pipe or apparatus for the supply of gas, water or electricity, or of any telecommunications apparatus as defined in paragraph 1(1) of Schedule 2 to the Telecommunications Act 1984<sup>(25)</sup>,

if the vehicle cannot be used for such a purpose without stopping on the length of road;

- (b) so as to prevent a vehicle stopping in a lay-by;
- (c) to a vehicle for the time being used for fire brigade, ambulance or police purposes;

---

(25) 1984 c. 12.

- (d) to a pedal bicycle not having a sidecar attached thereto, whether additional means of propulsion by mechanical power are attached to the bicycle or not;
- (e) to a vehicle stopping in any case where the person in control of the vehicle is required by law to stop, or is obliged to do so in order to avoid an accident, or is prevented from proceeding by circumstances outside his control;
- (f) to anything done with the permission or at the direction of a constable in uniform or in accordance with the direction of a traffic warden; or
- (g) to a vehicle on a road with more than one traffic lane in each direction.

(4) Nothing in paragraph (2)(b) shall be taken to prohibit a vehicle from being driven across, or so as to straddle, the continuous line referred to in that paragraph, if it is safe to do so and if necessary to do so—

- (a) to enable the vehicle to enter, from the side of the road on which it is proceeding, land or premises adjacent to the length of road on which the line is placed, or another road joining that road;
- (b) in order to pass a stationary vehicle;
- (c) owing to circumstances outside the control of the driver;
- (d) in order to avoid an accident;
- (e) in order to pass a road maintenance vehicle which is in use, is moving at a speed not exceeding 10 miles per hour, and is displaying to the rear the sign shown in diagram 610 or 7403;
- (f) in order to pass a pedal cycle moving at a speed not exceeding 10 miles per hour;
- (g) in order to pass a horse that is being ridden or led at a speed not exceeding 10 miles per hour; or
- (h) for the purposes of complying with any direction of a constable in uniform or a traffic warden.

(5) The warning conveyed by the road marking mentioned in paragraph (1) shall be that no vehicle while travelling next to a broken line placed on the left of a continuous line, as viewed in the direction of travel of the vehicle, should cross or straddle the first-mentioned line unless it is seen by the driver of the vehicle to be safe to do so.

### **Permitted variants**

**27.—**(1) Where the circumstances in which a road marking shown in a diagram in Schedule 6 is to be placed so require or where appropriate in those circumstances, the form of the marking shall or may be varied as follows

- (a) in the manner (if any) allowed or required in item 4 of the untitled table below or beside the diagram; or
- (b) in the manner allowed or required in column (3) of an item in Schedule 16, if the diagram is one whose number is given in column (2) of that item.

(2) In the road marking shown in diagram 1035, route numbers, place names and the direction in which any arrow-head points shall be varied to accord with the circumstances but the words “turn left”, “ahead” or “turn right” shall not be included in the marking.

(3) Where the form of a road marking is varied in accordance with this regulation, the information, warning, requirement, restriction, prohibition or speed limit conveyed by the marking is varied to accord with the form of marking as varied.



## **Illumination of road markings**

**28.**—(1) Subject to paragraph (2) a road marking shown in diagram 1001, 1002.1, 1003, 1003.1, 1003.3, 1003.4, 1004, 1004.1, 1005, 1005.1, 1008, 1008.1, 1009, 1010, 1012.1, 1012.2, 1012.3, 1013.1, 1013.3, 1014, 1022, 1023, 1024, 1024.1, 1036.1, 1036.2, 1037.1, 1039, 1040, 1040.2, 1040.3, 1040.4, 1040.5, 1041, 1042, 1046, 1049, 1060, 1060.1, 1061 or 1061.1 shall be illuminated with retroreflecting material.

(2) Paragraph (1) shall not apply to a road marking shown in diagram 1003, 1023 or 1049 when varied for use on a cycle track as defined in the Highways Act 1980 or The Roads (Scotland) Act 1984.

(3) Subject to paragraph (4), studs incorporating reflectors or retroreflecting material and so spaced as to form a single line of studs not less than 3 nor more than 4.5 metres apart shall be fitted—

- (a) between the two lines constituting the marking shown in diagram 1013.1 unless that marking—
  - (i) is placed on an automatic level crossing;
  - (ii) is placed on a length of the road situated within 90 metres of the transverse stop line shown in diagram 1001 provided in association with any such crossing; or
  - (iii) is so placed that the continuous lines shown in version B of diagram 1013.1 are more than 175 millimetres apart and are separated by an area of cross-hatching so shown;
- (b) between the two continuous parallel lines forming part of the marking shown in diagram 1013.3.

(4) Where the marking shown in diagram 1013.1 is placed in any of the cases referred to in paragraphs (i), (ii) and (iii) of paragraph (3)(a) then the studs mentioned in paragraph (3) shall be fitted either in opposite pairs within the width of each of the two lines or in a single line between them.

(5) Subject to the foregoing provisions of this regulation, and to paragraph (6), any road marking may be illuminated with retroreflecting material, and studs incorporating reflectors or retroreflecting material may be used with a road marking shown in diagram 1004, 1004.1, 1005, 1005.1, 1008, 1008.1, 1009, 1010, 1012.1, 1012.2, 1012.3, 1025.2, 1025.3, 1035, 1040, 1040.2, 1040.3, 1040.4, 1040.5, 1041 or 1042 in such a manner that any such stud shall not be fitted to any part of the marking coloured white or yellow but shall be applied to the surface of the carriageway in the gaps between parts of the marking.

(6) In the case of a road marking shown in diagram 1012.1, 1012.2, 1012.3 or 1042 the studs shall, if fitted, be applied to the surface of the carriageway at the side of and adjacent to the line shown in the diagram.

(7) Reflectors or retroreflecting material incorporated in studs shall be white except that in the case of studs used with a road marking shown in diagram 1009, 1010, 1012.1, 1012.2, 1012.3, 1025.2, 1025.3, 1040.3, 1041 or 1042 the reflectors or retroreflecting material shall reflect—

- (a) red light where the near side edge of a carriageway is indicated to drivers of approaching vehicles, or when placed in conjunction with the markings shown in diagrams 1041 and 1042 to indicate the off side edge of a carriageway;
- (b) amber light to indicate the off side edge of a carriageway which is contiguous to a central reservation or to traffic cones or cylinders at road works or the road marking shown in diagram 1040.3, or which carries traffic in one direction only; and
- (c) green light when placed in conjunction with a road marking shown in diagram 1009, 1010, 1025.2 or 1025.3 where the edge of any part of the carriageway available for through traffic at a road junction, a lay-by or a parking place is so indicated to drivers of approaching vehicles.

(8) The colour of the parts of the stud other than the reflectors or retroreflecting material shall either be the same as the reflectors or retroreflecting material, or be white, or be a natural metallic finish or other neutral colour, or shall be fluorescent green/yellow in the case of studs placed temporarily at road works.

### **Height of road markings and size of studs**

**29.**—(1) The size and shape of a stud incorporating reflectors or retroreflecting material shall be such that the part which is visible above the surface of the road can be contained within—

- (a) an overall length in the direction of travel of traffic of not less than 35 millimetres and not exceeding 250 millimetres; and
- (b) an overall width of not less than 84 millimetres and not exceeding 230 millimetres.

(2) No road marking or stud shall project above the surface of the adjacent carriageway more than 6 millimetres at any point except—

- (a) a depressible stud, which shall not project above that surface more than 25 millimetres at its highest point, whether depressed or not;
- (b) a non-depressible stud, which shall not project above that surface more than 20 millimetres at its highest point;
- (c) the road marking shown in diagram 1003.4, which shall not project above that surface more than 125 millimetres at its highest point or 6 millimetres at its perimeter;
- (d) the road marking shown in diagram 1012.2, the raised ribs on which shall project above the surface of the remainder of the marking by 11 millimetres; or
- (e) the road marking shown in diagram 1012.3, the raised ribs on which shall project above the surface of the remainder of the marking by 8 millimetres; and
- (f) the road marking shown in diagram 1049.1, the height of which above the surface of the adjacent carriageway shall be within the range of dimensions indicated on the second part of that diagram illustrating the cross-section of the marking.

(3) In this regulation, the expression “depressible stud” means a stud so fitted that the height by which it, or part of it, projects above the surface of the adjacent carriageway is apt to be reduced when pressure is applied to the stud from above; and “non-depressible stud” and “depressed” shall be construed accordingly.

## *SECTION 5*

### *LIGHT SIGNALS AND WARNING LIGHTS*

#### **Use of different types of light signals**

**30.**—(1) Light signals used for the control of vehicular traffic shall be of the size, colour and type prescribed in paragraph (2), (3), (5), (7) or (9).

(2) Subject to regulation 31, light signals used to control vehicular traffic at road junctions, at places where the headroom or the width of the road is permanently restricted, or at places where pedestrians cross the road (other than Pelican crossings) shall be of the size, colour and type shown in diagram 3000, 3000.3, 3000.4, 3000.5 or 3000.6 and be illuminated in the sequence prescribed in paragraph (4).

(3) Light signals used to control vehicular traffic consisting solely of pedal cycles shall be of the size, colour and type shown in diagram 3000.2 and be illuminated in the sequence prescribed in paragraph (4).

(4) The sequence of illumination of the lights shown by the signals prescribed in paragraphs (2) and (3) shall be as follows—

- (a) red,
- (b) red and amber together,
- (c) green,
- (d) amber,

provided that where the light signals are varied as prescribed in regulation 31, the green arrow shown in diagram 3000.4 or 3000.6 and shown as a permitted variant of diagram 3000.3 or 3000.5 or one of the green arrows shown as a permitted variant of diagram 3000.3, 3000.4 or 3000.6 may be illuminated while any of the lights referred to in sub-paragraphs (a), (b), (c) and (d) are illuminated.

(5) Light signals used to control vehicular traffic entering or proceeding along a motorway or dual carriageway road shall be—

- (a) of the size, colour and type shown in diagram 6031.1 or 6032.1; and
- (b) operated as prescribed in paragraph (6).

(6) The operating requirements for the light signals prescribed in paragraph (5) are that—

- (a) each lamp shall show an intermittent red light at a rate of flashing of not less than 60 nor more than 90 flashes per minute, and in such a manner that the lights of one vertical pair are always shown when the lights of the other vertical pair are not shown; and
- (b) the red cross or the white symbol shown in diagram 6031.1 or 6032.1 shall be illuminated by a steady light when the red lights are flashing.

(7) Light signals used to control road traffic at level crossings, swinging or lifting bridges, tunnels, airfields or in the vicinity of premises used regularly by fire, police or ambulance service vehicles shall be—

- (a) of the size, colour and type shown in diagram 3014; and
- (b) illuminated in the sequence prescribed in paragraph (8).

(8) The sequence for the illumination of the light signals prescribed in paragraph (7) shall be as follows—

- (a) a single steady amber light,
- (b) two intermittent red lights, each of which will be shown at a rate of flashing of not less than 60 nor more than 90 flashes per minute, and in such a manner that one light is always shown when the other light is not shown.

(9) Light signals used to control tramcars shall—

- (a) be of the size, colour and type shown in diagram 3013; and
- (b) display the aspects shown in diagrams 3013.1, 3013.2, 3013.3, 3013.4 and 3013.5 in the sequence prescribed in paragraph (10).

(10) The sequence for the illumination of the light signals prescribed in paragraph (9) shall be as follows—

- (a) the horizontal line shown in diagram 3013.1,
- (b) the vertical line shown in diagram 3013.2 or either of the diagonal lines shown in diagram 3013.3 or 3013.4,
- (c) the central circle shown in diagram 3013.5.

(11) When the light signals prescribed in paragraph (9) (“tram signals”) are affixed to the light signals mentioned in paragraph (2) (“standard signals”) in the manner shown in diagram 3000.3, 3000.4, 3000.5 or 3000.6 their aspect may be such that they convey to the driver of a tramcar a

significance (within the meaning of regulation 33) which is different from that conveyed at the same time to the drivers of other vehicular traffic by the aspect of the standard signals to which the tram signals are affixed.

### **Permitted variants of green arrow light signals**

**31.**—(1) A lens or lenses of the size and colour shown in either diagram 3001 or 3001.1 which, when illuminated, shows a green arrow

- (a) may be substituted for the lens showing the green light in the light signals referred to in regulation 30(2) using any of the methods shown in diagram 3003, 3005, 3006, 3011.1 or 3011.2; or
- (b) may be affixed to the light signals referred to in regulation 30(2) or to those signals as altered in accordance with sub-paragraph (a) using any of the methods shown in diagram 3000.4, 3000.6, 3002, 3004, 3005, 3006, 3007, 3008, 3009.1, 3011.1 or 3011.2.

(2) The direction of the arrow prescribed as the permitted variant of diagram 3000.3 and shown in diagram 3000.4 may be varied so that the head of the arrow points to any position on the 90° arc shown in diagram 3002 or 3004.

(3) The direction of the arrow prescribed as the permitted variant of diagrams 3000 and 3000.5 and shown in diagram 3000.6 may be varied so that the head of the arrow points to any position on the 180° arc shown in diagram 3003 or 3009.1.

(4) The direction of any arrow prescribed as a permitted variant of diagrams 3000.3 and 3000.4 where the arrow is substituted for the green light may be varied so that the head of the arrow points to any position on the 90° arcs shown in diagram 3005 or 3006, provided that there is a difference of not less than 45° between the directions in which paired arrows point.

(5) The direction of either of the green arrows included in diagram 3000.4, where the sign shown in that diagram has been varied by the substitution of a green arrow for the tram signal aspect, may be varied so that the head of the arrow points to any position on the 45° arcs shown in diagram 3007 or 3008 provided that there is a difference of not less than 45° between the directions in which paired arrows point.

(6) The direction of either of the green arrows included in diagram 3000.6, where the sign shown in that diagram has been varied by the substitution of a green arrow for the tram signal aspect, may be varied so that—

- (a) when the arrows are illuminated and extinguished simultaneously, the head of the upper arrow may point in any direction on the 135° arc and the head of the lower arrow may point in any direction on either of the two 45° arcs shown in diagram 3011.1, provided that there is a difference of not less than 45° between the directions in which the two arrows point ; and
- (b) when the arrows are illuminated and extinguished independently, the head of either of the arrows may point in any direction on the two 180° arcs shown in diagram 3011.2, provided that there is a difference of not less than 45° between the directions in which the two arrows point.

### **Portable light signals**

**32.** Portable light signals—

- (a) shall be of the size, colour and type shown in diagram 3000.1; and
- (b) shall be illuminated in the sequence prescribed by regulation 30(4).

### Significance of light signals

33.—(1) The significance of the light signals prescribed in paragraphs (2) and (3) of regulation 30 and in regulation 32 shall be as follows—

- (a) except as provided in sub-paragraphs (b), (f) and (g) the red signal shall convey the prohibition that vehicular traffic other than tramcars shall not proceed beyond the stop line;
- (b) when a vehicle is being used for fire brigade, ambulance or police purposes and the observance of the prohibition conveyed by the red signal in accordance with sub-paragraph (a) would be likely to hinder the use of that vehicle for the purpose for which it is being used, then sub-paragraph (a) shall not apply to the vehicle, and the red signal shall convey the prohibition that that vehicle shall not proceed beyond the stop line in a manner or at a time likely to endanger any person or to cause the driver of any vehicle proceeding in accordance with the indications of light signals operating in association with the signals displaying the red signal to change its speed or course in order to avoid an accident;
- (c) except as provided in sub-paragraph (f), the red-with-amber signal shall denote an impending change to green or a green arrow in the indication given by the signals but shall convey the same prohibition as the red signal;
- (d) the green signal shall indicate that vehicular traffic other than tramcars may proceed beyond the stop line and proceed straight on or to the left or to the right;
- (e) the amber signal shall, when shown alone, convey the same prohibition as the red signal, except that, as respects any vehicle other than a tramcar which is so close to the stop line that it cannot safely be stopped without proceeding beyond the stop line, it shall convey the same indication as the green signal or green arrow signal which was shown immediately before it;
- (f) save as provided in sub-paragraph (g), the green arrow signal shall indicate that vehicular traffic other than tramcars may, notwithstanding any other indication given by the signals, proceed beyond the stop line only in the direction indicated by the arrow for the purpose of proceeding in that direction through the junction controlled by those signals; and
- (g) where more than one green arrow is affixed to light signals in accordance with regulation 31(1)(b), vehicular traffic other than tramcars may, notwithstanding any other indication given by the signals, proceed beyond the stop line only in the direction indicated by any one of the green arrows for the purpose of proceeding in that direction through the junction controlled by those signals.

(2) Vehicular traffic proceeding beyond a stop line in accordance with paragraph (1) shall proceed with due regard to the safety of other road users and subject to any direction given by a constable in uniform or a traffic warden or to any other applicable prohibition or restriction.

(3) The significance of the light signals prescribed in regulation 30(5) shall be as follows—

- (a) when placed beside the carriageway of a road, they shall convey the prohibition that vehicular traffic (other than vehicles being used in the circumstances described in paragraph (1)(b)) shall not proceed beyond the signals; and
- (b) when displayed on a gantry over the carriageway, they shall convey the prohibition that vehicular traffic (other than vehicles being used in the circumstances described in paragraph (1)(b)) proceeding in the traffic lane immediately below the signals shall not proceed beyond them in that lane,

and for the purposes of this paragraph light signals which are mounted on a post situated beside the carriageway but which are projected over it or part of it shall be treated as light signals placed beside the carriageway of that road.

(4) The significance of the light signals prescribed in regulation 30(7) shall be as follows—

- (a) the amber signal shall convey the prohibition that traffic shall not proceed beyond the stop line on the carriageway, except for a vehicle which is so close to the stop line that it cannot safely be stopped without proceeding beyond the stop line; and
  - (b) the intermittent red signals shall convey the prohibition that traffic shall not proceed beyond the stop line.
- (5) The significance of the light signals prescribed in regulation 30(9) shall be as follows—
- (a) the aspect shown in diagram 3013.1 shall convey the prohibition that a tramcar shall not proceed beyond the stop line;
  - (b) the aspect shown in diagram 3013.2 shall indicate that a tramcar may proceed beyond the stop line and proceed straight ahead;
  - (c) the aspect shown in diagram 3013.3 shall indicate that a tramcar may proceed beyond the stop line and proceed to the left;
  - (d) the aspect shown in diagram 3013.4 shall indicate that a tramcar may proceed beyond the stop line and proceed to the right; and
  - (e) the aspect shown in diagram 3013.5 shall convey the prohibition that a tramcar shall not proceed beyond the stop line except that, as respects a tramcar which is so close to the stop line that it cannot safely be stopped without proceeding beyond the stop line, it shall convey the same indication as the aspect which was shown immediately before it.
- (6) In this regulation—
- (a) “primary signals” means light signals erected on or near the carriageway of a road and sited near either one or both ends of the stop line, or if there is no stop line, sited at either or both edges of the carriageway or part of the carriageway which is in use by traffic approaching and controlled by the signals;
  - (b) “secondary signals” means light signals erected on or near the carriageway facing traffic approaching from the direction of the primary signals but sited beyond those signals as viewed from the direction of travel of such traffic;
  - (c) “stop line” in relation to light signals means the road marking shown in diagram 1001 placed on a carriageway in conjunction with those light signals being either primary signals alone, or secondary signals alone or both primary and secondary signals and, where no stop line is provided or the stop line is not visible, references in the preceding paragraphs of this regulation to the stop line are—
    - (i) in a case where the sign shown in diagram 7011 is placed in conjunction with the light signals, to be treated as references to that sign; and
    - (ii) in any other case, to be treated as references to the post or other structure on which the primary signals are mounted; and
  - (d) any reference to light signals, to the signals or to a signal of a particular colour is, where secondary signals have been placed, a reference to the light signals displayed by both the primary and secondary signals or, as the case may be, by the primary signals operating without the secondary signals or by the secondary signals operating without the primary signals.

### **Light signals for lane control of vehicular traffic**

**34.—(1)** A light signal placed above the carriageway and facing the direction of oncoming vehicular traffic used for the control of that traffic proceeding along the traffic lane over which those signals have been placed shall be of the size, colour and type shown in diagram 5001.1, 5001.2, 5003, 5003.1, 5005 or 5005.1.

(2) The height of the centre of each light signal from the surface of the carriageway in the immediate vicinity shall be not less than 5.5 metres nor more than 9 metres.

(3) The signals prescribed by this regulation shall be so designed that—

- (a) the red cross shown in diagram 5003 or 5003.1 (“the red cross”) can be internally illuminated in such a manner as to show a steady red light;
- (b) the green arrow shown in diagram 5001.1 or 5001.2 (“the downward green arrow”) can be internally illuminated in such a manner as to show a steady green light;
- (c) the white arrow shown in diagram 5005 or 5005.1 (“the diagonal white arrow”) can be internally illuminated in such a manner as to show a steady white light; and
- (d) whenever one of the signals referred to in sub-paragraphs (a) to (c) is illuminated neither of the other signals referred to in those sub-paragraphs shall be illuminated when placed over the same traffic lane.

(4) The significance of the light signals prescribed in this regulation shall be as follows—

- (a) the red cross shall convey to vehicular traffic proceeding in the traffic lane above which it is displayed the prohibition that such traffic shall not proceed beyond the red cross in the traffic lane until that prohibition is cancelled by a display over that traffic lane of the downward green arrow or diagonal white arrow or by a display over that traffic lane or beside the carriageway of the traffic sign shown in diagram 5015 or 6001;
- (b) the downward green arrow shall convey to vehicular traffic proceeding in the traffic lane above which it is displayed the information that such traffic may proceed or continue to do so in the lane beneath the arrow; and
- (c) the diagonal white arrow shall convey to vehicular traffic proceeding in the traffic lane above which it is displayed the warning that such traffic should move into the adjacent traffic lane in the direction indicated by the arrow as soon as traffic conditions permit.

### **Warning signal for motorways and dual carriageway roads**

**35.**—(1) A traffic sign for conveying the warning specified in paragraph (2) to vehicular traffic on a motorway or a dual carriageway road shall be a light signal of the size, colour and type shown in diagram 6023.

(2) The warning conveyed by the light signal shall be that—

- (a) there is a hazard ahead on the motorway or dual carriageway road; and
- (b) drivers should drive at a speed which does not exceed 30 miles per hour until they are certain that the hazard has been passed or removed.

(3) When the light signal prescribed by this regulation is operated, each lamp shall show an intermittent amber light at a rate of flashing of not less than 60 nor more than 90 flashes per minute and in such a manner that one light is always shown when the other light is not shown.

### **Matrix signs for motorways and dual carriageway roads**

**36.**—(1) In this regulation “matrix sign” means a sign shown in a diagram in Part I of Schedule 11 for conveying to traffic on motorways and dual carriageway roads information or a warning, requirement, restriction, prohibition or speed limit—

- (a) relating to or arising out of temporary hazardous conditions on or near the motorway or dual carriageway road; and
- (b) specified under a diagram contained in Part I of that Schedule.

(2) A matrix sign shall be a light signal and shall be of the size, colour and type prescribed by this regulation and shown in a diagram in Part I of Schedule 11.

(3) Where a matrix sign is placed beside the carriageway of a road the warning, requirement, restriction, prohibition or speed limit conveyed by the sign shall apply to all vehicular traffic facing that sign and proceeding along the carriageway beside which the sign is placed.

(4) For the purposes of this regulation a sign which is mounted on a post situated beside the carriageway but is projected over it or part of it shall be treated as a sign placed beside the carriageway of that road.

(5) Where a matrix sign mounted on a gantry or other structure is so placed that a traffic lane of the carriageway passes directly beneath it, the warning, requirement, restriction, prohibition or speed limit conveyed by the sign shall apply only to vehicular traffic facing that sign and proceeding along the traffic lane passing directly beneath it.

(6) The legend or symbol in a matrix sign shall be displayed by means of white or off-white light and except in the case of the sign shown in diagram 6012 shall be accompanied by the four lamps prescribed in paragraph (7).

(7) The four lamps mentioned in paragraph (6)—

- (a) shall be of the size, colour and type shown in diagram 6022 when placed beside the carriageway or in diagram 6021 when mounted on a gantry or other structure over the carriageway; and
- (b) when a matrix sign other than the one shown in diagram 6012 is displayed, each lamp shall show an intermittent amber light at a rate of flashing of not less than 60 nor more than 90 flashes per minute and in such a manner that one horizontal pair of lights is always shown when the lights of the other horizontal pair of lights is not shown.

### **Light signals for pedestrians**

**37.**—(1) Light signals for conveying to pedestrians the information mentioned in paragraph (3) shall be of the size, colour and type shown in diagram 4002.

(2) The signals shall be so designed that—

- (a) the red figure shown in diagram 4002 (“the red signal”) can be internally illuminated by a steady light;
- (b) the green figure shown in diagram 4002 (“the green signal”) can be internally illuminated by a steady light;
- (c) when one signal is illuminated the other signal is not illuminated; and
- (d) the green signal is and remains illuminated only for so long as there is conveyed to vehicular traffic a requirement, prohibition or restriction against entering that part of the carriageway across which the light signals for pedestrians are facing, being a requirement, prohibition or restriction indicated by—
  - (i) the light signals prescribed in paragraphs (2), (3) or (9) of regulation 30;
  - (ii) the light signals prescribed in regulation 30(2) varied in accordance with regulation 31 as respects the direction of the green arrow; or
  - (iii) a traffic sign shown in diagram 606, 612, 613 or 616.

(3) The period during which, in the interests of safety, pedestrians—

- (a) should not cross the carriageway shall be shown by the red signal during such time as it is illuminated; and
- (b) may cross the carriageway shall be shown by the green signal during such time as it is illuminated by the steady light.



(4) Any audible signal emitted by any device for emitting audible signals provided in conjunction with the green signal, and any tactile signal made by any device for making tactile signals similarly provided, shall convey to pedestrians the information mentioned in paragraph (3)(b).

(5) A sign of the size, colour and type shown in diagram 4003 shall during such time as the word “WAIT” is illuminated indicate to pedestrians the warning mentioned in sub-paragraph (a) of paragraph (3).

**38.—**(1) Light signals conveying to pedestrians at level crossings the prohibition mentioned in paragraph (2) shall be of the size, colour and type shown in diagram 4006 and so designed that—

- (a) the red figure shown in diagram 4006 is internally illuminated by an intermittent red light which is shown at a rate of flashing of not less than 60 nor more than 90 flashes per minute; and
- (b) the red figure is illuminated only when the intermittent red lights prescribed in regulation 30(8)(b) are illuminated.

(2) The red figure when illuminated in the manner described in paragraph (1) shall convey the prohibition that pedestrians shall not proceed beyond the transverse road marking shown in diagram 1003.2 on the footway or diagram 1001 on the carriageway.

#### **School crossing patrol signs and warning lights**

**39.—**(1) A sign which is exhibited by a school crossing patrol for the purpose of stopping any vehicle in accordance with section 28 of the 1984 Act shall be of the size, colour and type shown in diagram 605.2.

(2) A sign for conveying a warning to vehicular traffic, which is approaching a place in a road where children on their way to or from school or on their way from one part of a school to another cross or seek to cross that road (“a crossing place”), that the crossing place lies ahead and is being patrolled by a school crossing patrol or is otherwise in use by such children—

- (a) shall be a light signal of the size, colour and type shown in diagram 4004, each lamp of which when operated shall show an intermittent amber light at a rate of flashing of not less than 60 nor more than 90 flashes per minute and in such a manner that one light is always shown when the other light is not shown; and
- (b) may be erected on or near part of the road in advance of a crossing place in relation to oncoming traffic.

#### **Cattle crossing signs and warning lights**

**40.—**(1) A sign of the size, colour and type shown in diagram 4005 may be erected on or near a road in advance of a place in that road where cattle under the supervision of a herdsman on their way from one part of a farm to another cross the road (“a cattle crossing”) to convey to oncoming traffic the warning specified in paragraph (2).

(2) The warning conveyed by the sign shall be that—

- (a) a cattle crossing lies ahead and may be in use; and
- (b) traffic should be prepared to stop.

(3) When the sign is operated, each lamp shall show an intermittent amber light at a rate of flashing of not less than 60 nor more than 90 flashes per minute and in such a manner that one light is always shown when the other light is not shown.

## SECTION 6

### MISCELLANEOUS TRAFFIC SIGNS

#### Certain temporary signs

**41.**—(1) A temporary sign shall be of such size, colour and type as is specified in this regulation.

(2) The shape of a temporary sign shall be—

- (a) rectangular;
- (b) rectangular but with the corners rounded; or
- (c) pointed at one end but otherwise rectangular in accordance with (a) or (b).

(3) A temporary sign may incorporate—

- (a) wording;
- (b) numerals;
- (c) arrows or chevrons;
- (d) any appropriate symbol taken from any diagram in any Schedule; and
- (e) the arms, badge or other device of a traffic authority, police authority or an organisation representative of road users,

and shall be of a size appropriate to the circumstances in which it is placed.

(4) Every letter and numeral incorporated in a temporary sign other than any letter incorporated in the sign in accordance with paragraph (3)(e) shall be not less than 40 nor more than 350 millimetres in height, and every arrow so incorporated shall be not less than 250 nor more than 1000 millimetres in length.

(5) Every letter, numeral, arrow, chevron or symbol, other than a sign shown in a diagram in Schedules 1 to 5 when used as a symbol, incorporated in a temporary sign shall be—

- (a) black on a background of white or of yellow;
- (b) white on a blue background;
- (c) blue on a white background;
- (d) if the sign conveys information or warnings of the kind mentioned in sub-paragraphs (c) or (d) of paragraph (7), white on a red background, except where it is placed on a motorway when it shall be black on a yellow background; or
- (e) if the sign is a variable message sign, yellow on a black background or black on a yellow background, except when the sign is not in use when it shall display a plain black or grey face.

(6) No temporary sign shall convey to traffic any information, warning, requirement, restriction or prohibition of a description which can be conveyed either by a sign shown in a diagram in Schedules 1 to 12 or by a sign so shown placed in combination or in conjunction with another sign so shown in such a diagram.

(7) In this regulation “temporary sign” means a sign placed temporarily on or near a road for conveying to traffic—

- (a) information as respects deviations or alternative traffic routes;
- (b) information as respects the route which may conveniently be followed on the occasion of a sports meeting, exhibition or other public gathering which in each case it is anticipated will attract a considerable volume of traffic;
- (c) information as to the date from which works are to be executed on or near a road;

- (d) information or warnings as to the avoidance of any temporary hazards occasioned by works being executed on or near a road, by adverse weather conditions or other natural causes, by the failure of street lighting or by malfunction of or damage to any apparatus, equipment or facility used in connection with the road or anything situated on, near or under it or by damage to the road itself; or
- (e) requests for information by the police in connection with a road traffic accident.

### **Flashing beacons**

**42.**—(1) A beacon—

- (a) showing an intermittent amber light and placed in combination with a temporary sign within the meaning of regulation 41 or the sign shown in diagram 562, 610, 7001, 7009, 7010, 7012, 7013, 7019, 7020, 7021 or 7022, and in compliance with the requirements in paragraph (2); or
- (b) showing an intermittent blue light and placed by a constable or a person acting under instructions (whether general or specific) of the chief officer of police in combination with a sign shown in diagram 606, 609, 610, 616, 633, 829.1, 829.2, 829.3, 829.4 or 7105, and in compliance with (c) and (d) of the requirements in paragraph (2),

shall convey the warning that drivers of vehicles should take special care.

(2) The requirements mentioned in paragraph (1) are—

- (a) the peak intensity of light emitted by the lens or lenses of each such beacon shall be—
  - (i) if the period between individual flashes does not exceed of a second, not less than 100 candela on the principal axis of the relevant lens;
  - (ii) if the period between individual flashes exceeds of a second, not less than 2000 candela on the principal axis; or
  - (iii) if the period between the cessation of a double flash and the start of the succeeding double flash exceeds of a second, not less than 1000 candela on the principal axis;
- (b) each lens shall be of such a shape and size that the perimeter of its area projected horizontally onto a vertical plane shall be capable of lying wholly inside a square having sides of 200 millimetres in length and wholly outside a square having sides of 100 millimetres in length;
- (c) the height of the centre of the lenses from the surface of the carriageway in the immediate vicinity shall be not less than 800 nor more than 1500 millimetres; and
- (d) the rate of flashing shall be not less than 40 nor more than 150 individual or double flashes per minute.

### **Road danger lamps**

**43.**—(1) A lamp showing a steady or intermittent amber light which—

- (a) conforms to British Standard Specification BS3143: Part 1: 1985 amended by Amendment No.1 dated February 1985; or BS3143: Part 2: 1990; or an equivalent specification of a European Economic Area State; and
- (b) is illuminated separately and by a single source of light,

shall indicate to traffic the limits of a temporary obstruction of the road and in this regulation is called a “road danger lamp”.

(2) The height of the centre of each lens of a road danger lamp from the surface of the road in the immediate vicinity of the lamp shall not exceed 1500 millimetres where the speed limit on the

road is 40 miles per hour or less, or 1200 millimetres where the speed limit on the road is more than 40 miles per hour.

- (3) Where a road danger lamp which shows an intermittent light is placed—
- (a) within 50 metres of a street lamp lit by electricity on a road subject to a speed limit of 40 miles per hour or less, the lamp shall operate in such a way that the rate of flashing shall be not less than 40 nor more than 150 flashes per minute; and
  - (b) on roads other than those mentioned in sub-paragraph (a), the rate of flashing shall be not less than 900 flashes per minute.

### **Cones, delineators and cylinders**

**44.**—(1) The sign shown in diagram 7101 shall, subject to paragraph (2), consist of a conically shaped device made of rubber or flexible plastic material of which—

- (a) the base is coloured red, black, grey or brown;
- (b) the base is a polygon having not more than eight sides, which would be contained wholly within a circle with a diameter of three quarters of the height of the device; and
- (c) the part of the device coloured white is illuminated with white retroreflecting material,

and information about the manufacture of the sign required in order to comply with British Standard Specification BS 873: Part 8: 1985 or an equivalent specification of a European Economic Area State, occupying an area not exceeding 30 square centimetres, may be indicated on the part of the sign coloured white in characters not exceeding 5 millimetres in height, at least 90% of the remaining area of white colour shall be illuminated with white retroreflecting material, and the part of the device coloured red may be illuminated with red retroreflecting material.

(2) A rotating device which is red and not illuminated by means of retroreflecting material and which displays one or more of the signs shown in diagram 560 or 561, which shall be coloured amber, intermittently while rotating and constantly while static, may be mounted on top of the sign shown in diagram 7101.

(3) The sign shown in diagram 7102 shall consist of a device made of rubber or flexible plastic material of which—

- (a) the base is coloured red, black, grey or brown, except that a white line 100 millimetres wide at an angle of not more than 60° to the road surface and illuminated with retroreflecting material may be marked on one side of the base at right angles to the face of the device;
- (b) the base has a maximum width (measured parallel to the face of the device) of three quarters of the height of the device, a minimum length of three quarters of the height of the device and is no more than 70 millimetres high at the outermost edge; and
- (c) the part of the device coloured white is illuminated with white retroreflecting material,

and information about the manufacture of the sign required in order to comply with British Standard Specification BS 873: Part 8: 1985 or an equivalent specification of a European Economic Area State, occupying an area not exceeding 30 square centimetres, may be indicated on the part of the sign coloured white in characters not exceeding 5 millimetres in height and, if only one side of the device is illuminated in accordance with this paragraph, the reverse side shall be coloured red or grey in material which is not retroreflecting, and the part of the device coloured red may be illuminated with red retroreflecting material.

(4) The sign shown in diagram 7103 shall consist of a cylindrically shaped device made of rubber or flexible plastic material and—

- (a) the part of the device coloured white shall be illuminated with white retroreflecting material; and

- (b) information about the manufacture of the sign required in order to comply with British Standard Specification BS 873: Part 8: 1985 or an equivalent specification of a European Economic Area State, occupying an area not exceeding 30 square centimetres, may be indicated on the part of the sign coloured white in characters not exceeding 5 millimetres in height, and at least 90% of the remaining area of white colour shall be illuminated with white retroreflecting material; and
- (c) the part of the device coloured red may be illuminated with red retroreflecting material.

### **Refuge indicator lamps**

**45.** A lamp in the form of an illuminated spherical globe for conveying the warning that drivers of vehicles are approaching a street refuge may be placed subject to the following conditions—

- (a) the globe shall be white;
- (b) the globe shall have a diameter of not less than 290 nor more than 310 millimetres; and
- (c) the height of the centre of the globe above the surface of the carriageway in the immediate vicinity shall be not less than 3800 millimetres nor more than 5000 millimetres.

### **Variable message signs**

**46.—**(1) A device may display at different times—

- (a) a sign shown in a diagram in Schedules 1 to 5, 7, 11 or 12;
- (b) a legend of a type shown in Schedule 15 in accordance with the provisions of that Schedule; or
- (c) a blank grey or a blank black face,

and in these Regulations such a device is referred to as a “variable message sign”.

(2) A variable message sign shall be of a size appropriate to display the messages referred to in sub-paragraphs (a) and (b) of paragraph (1), having regard to the normal speed of traffic on the road on or near which the sign is situated.

(3) If the construction or method of operation of a variable message sign prevents the sign from being displayed in the colours shown for it in the appropriate diagram in Schedules 1 to 5, 7, Part I of Schedule 11 or Schedule 12, a black legend or symbol on a white or yellow background may be displayed as a white, off-white or yellow legend or symbol on a dark background, provided that any red triangle or red circle forming part of the sign is retained.

(4) When a variable message sign displays the sign shown in diagram 670, any sign shown in a diagram in Part I of Schedule 11 other than diagram 6012, or a legend of the type shown in Schedule 15, it may also display four lamps of the size, colour and type specified in regulation 36(7), save that the rate of flashing shall be not less than 60 nor more than 150 flashes per minute and the distance between the lamps shall be varied to accord with the overall size of the variable message sign.

(5) The display of a blank black or grey face on a variable message sign accompanied by four flashing lamps of the kind mentioned in paragraph (4) shall indicate to drivers that they should take special care.

(6) A variable message sign which displays alternately the signs shown in diagrams 7023 and 7024 shall be manually operated.

**Status:** This is the original version (as it was originally made). This item of legislation is currently only available in its original format.

## SCHEDULE 1

Regulation 11(1) and (5)

### WARNING SIGNS

(other than those for railway and tramway level crossings, bus and pedal cycle facilities, and road works)

**Status:** This is the original version (as it was originally made). This item of legislation is currently only available in its original format.

**SCHEDULE 1  
WARNING SIGNS**

Regulation 11(1)  
and (5)

(other than those for railway and tramway level crossings,  
bus and pedal cycle facilities, and road works)

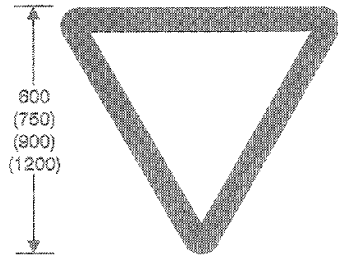

501

Junction ahead controlled by a diagram 601.1 ("STOP") or diagram 602 ("GIVE WAY") sign

Item	
1	Regulations: None
2	Directions: 18, 19
3	Diagrams: 502, 603, 608
4	Permitted variants: None
5	Illumination requirements: Schedule 17, item 1

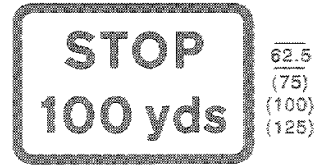

502

Distance to a junction ahead controlled by a diagram 601.1 ("STOP") sign

Item	
1	Regulations: None
2	Directions: 18, 19
3	Diagrams: 501
4	Permitted variants: Schedule 16, item 8
5	Illumination requirements: Schedule 17, item 8

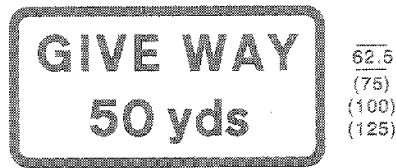

503

Distance to a junction ahead controlled by a diagram 602 ("GIVE WAY") sign

Item	
1	Regulations: None
2	Directions: 18, 19
3	Diagrams: 501
4	Permitted variants: Schedule 18, item 8
5	Illumination requirements: Schedule 17, item 8

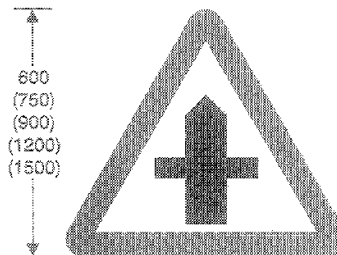

504.1

Crossroads ahead

Item	
1	Regulations: None
2	Directions: 19
3	Diagrams: 511, 572
4	Permitted variants: Schedule 16, item 17
5	Illumination requirements: Schedule 17, item 1

Status: This is the original version (as it was originally made). This item of legislation is currently only available in its original format.

SCHEDULE 1 WARNING SIGNS (contd.)

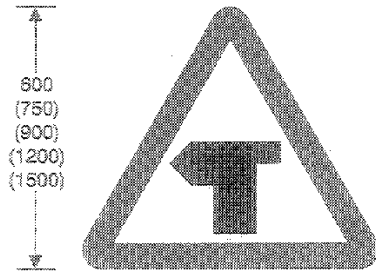

505.1  
T-junction ahead

Item	
1	Regulations: None
2	Directions: 19
3	Diagrams: 511, 572
4	Permitted variants: Schedule 18, item 28
5	Illumination requirements: Schedule 17, item 1

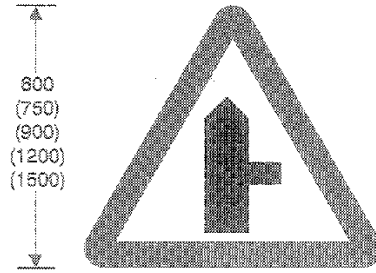

506.1  
Side road ahead

Item	
1	Regulations: None
2	Directions: 19
3	Diagrams: 511, 572, 7301, 7302
4	Permitted variants: Schedule 16, items 17, 28
5	Illumination requirements: Schedule 17, item 1

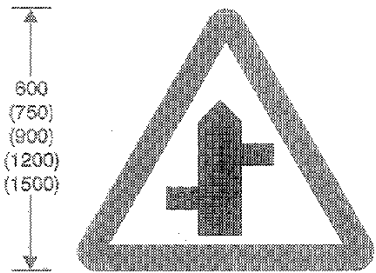

507.1  
Staggered junction ahead

Item	
1	Regulations: None
2	Directions: 19
3	Diagrams: 511, 572
4	Permitted variants: Schedule 16, items 17, 28
5	Illumination requirements: Schedule 17, item 1

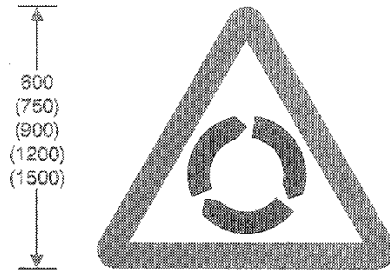

510  
Roundabout ahead

Item	
1	Regulations: None
2	Directions: 19
3	Diagrams: 511
4	Permitted variants: None
5	Illumination requirements: Schedule 17, item 1



**Status:** This is the original version (as it was originally made). This item of legislation is currently only available in its original format.

SCHEDULE 1 WARNING SIGNS (contd.)

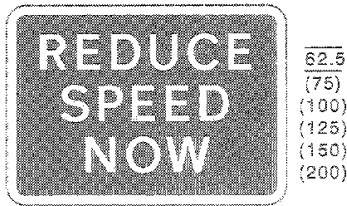

511  
Reduction in speed necessary for a change in road layout ahead

Item	
1	Regulations: None
2	Directions: 19
3	Diagrams: 504.1, 505.1, 506.1, 507.1, 510, 512, 512.1, 512.2, 513, 516, 517, 520, 523.1, 524.1, 525, 556
4	Permitted variants: "REDUCE SPEED NOW" may be varied to "HEAVY PLANT CROSSING" when used in combination with any of the signs in diagrams 504.1, 505.1, 506.1, 507.1, 512.1, 512.2
5	Illumination requirements: Schedule 17, item 9

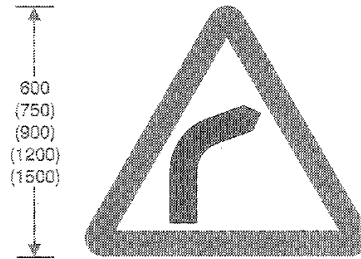

512  
Bend ahead

Item	
1	Regulations: None
2	Directions: 19
3	Diagrams: 511, 513.1, 513.2, 526
4	Permitted variants: Schedule 16, item 26
5	Illumination requirements: Schedule 17, item 1

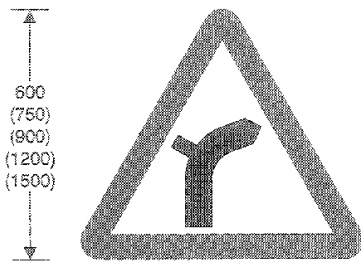

512.1  
Junction on bend ahead

Item	
1	Regulations: None
2	Directions: 19
3	Diagrams: 511, 513.1, 513.2, 526
4	Permitted variants: Schedule 16, item 26
5	Illumination requirements: Schedule 17, item 1

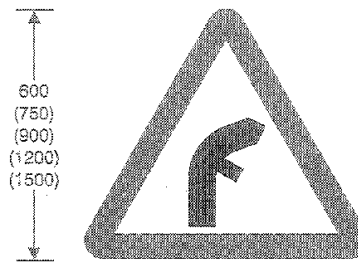

512.2  
Same as diagram 512.1

Item	
1	Regulations: None
2	Directions: 19
3	Diagrams: 511, 513.1, 513.2, 526
4	Permitted variants: Schedule 16, item 26
5	Illumination requirements: Schedule 17, item 1

**Status:** This is the original version (as it was originally made). This item of legislation is currently only available in its original format.

SCHEDULE 1 WARNING SIGNS (contd.)

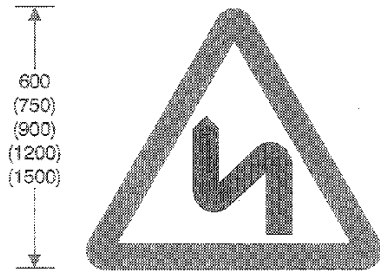

513  
Double bend ahead, first to the left

Item	
1	Regulations: None
2	Directions: 19
3	Diagrams: 511, 513.1, 513.2, 526, 570
4	Permitted variants: Schedule 16, item 2B
5	Illumination requirements: Schedule 17, item 1



513.1  
Adverse camber on a bend

Item	
1	Regulations: None
2	Directions: 19
3	Diagrams: 512, 512.1, 512.2, 513
4	Permitted variants: None
5	Illumination requirements: Schedule 17, item 8

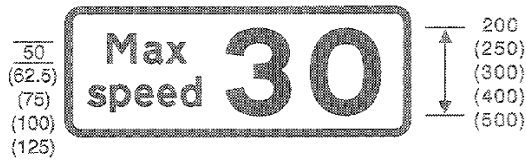

513.2  
Advisory speed limit at a bend or other hazard

Item	
1	Regulations: None
2	Directions: 19
3	Diagrams: 512, 512.1, 512.2, 513, 7009
4	Permitted variants: Schedule 16, item 1
5	Illumination requirements: Schedule 17, item 8

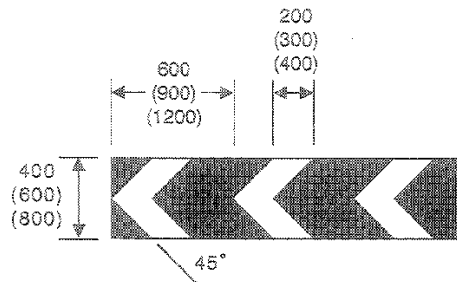

515  
Sharp deviation of route

Item	
1	Regulations: None
2	Directions: None
3	Diagrams: 515.2, 606
4	Permitted variants: Schedule 16, item 13 Number of chevrons may be varied
5	Illumination requirements: Schedule 17, item 4

**Status:** This is the original version (as it was originally made). This item of legislation is currently only available in its original format.

SCHEDULE 1 WARNING SIGNS (contd.)

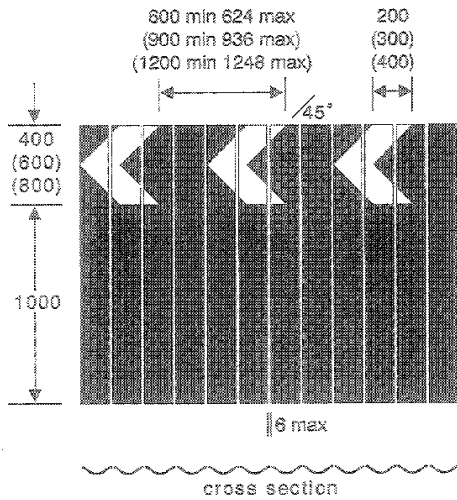

515.1  
Same as diagram 515

Item	
1	Regulations: 11(2)
2	Directions: None
3	Diagrams: None
4	Permitted variants: Schedule 18, items 13, 42 same as diagram 515
5	Illumination requirements: Schedule 17, item 4

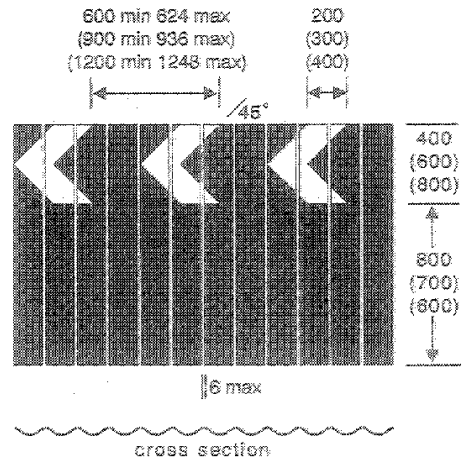

515.1A  
Sharp deviation of route at a roundabout

Item	
1	Regulations: 11(2)
2	Directions: 18(3)
3	Diagrams: 515.2, 806
4	Permitted variants: Schedule 18, item 42 same as diagram 515
5	Illumination requirements: Schedule 17, item 4

Status: This is the original version (as it was originally made). This item of legislation is currently only available in its original format.

SCHEDULE 1 WARNING SIGNS (contd.)

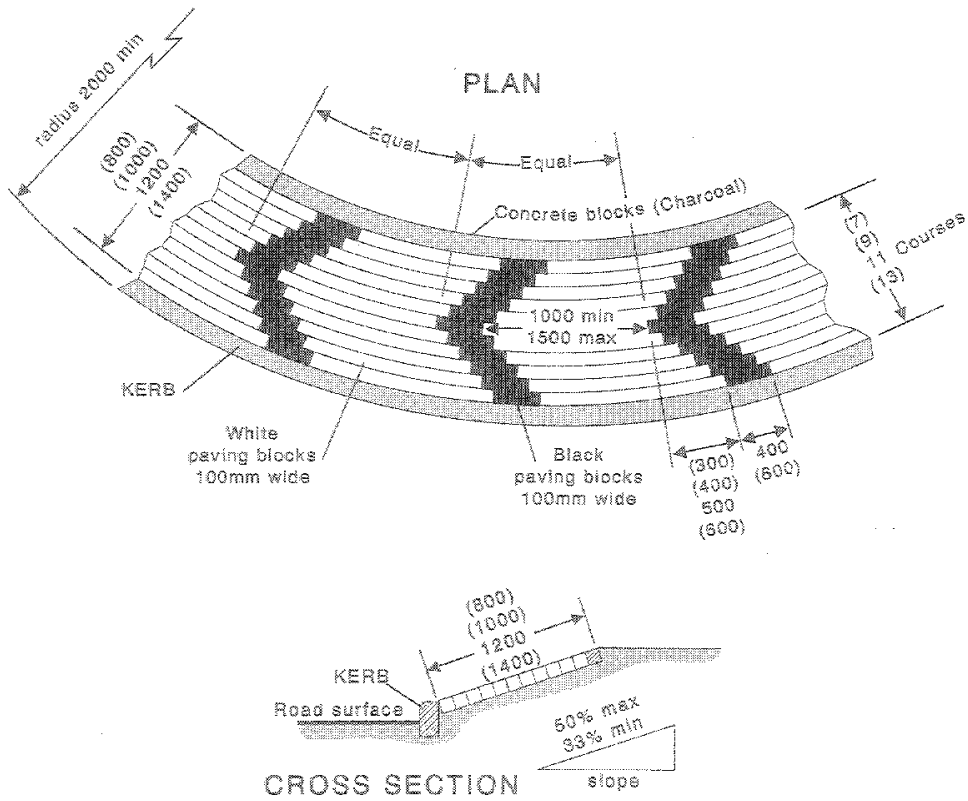

515.2  
Same as diagram 515.1A

Item	
1	Regulations: 11(2)
2	Directions: 18(3)
3	Diagrams: 515, 515.1A, 606
4	Permitted variants: None
5	Illumination requirements: Schedule 17, item 15

**Status:** This is the original version (as it was originally made). This item of legislation is currently only available in its original format.

SCHEDULE 1 WARNING SIGNS (contd.)

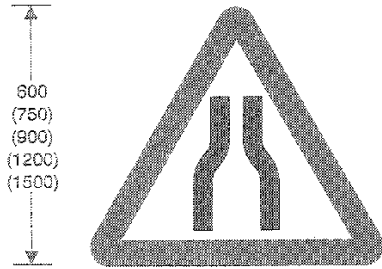

516  
Road narrows on both sides ahead

Item	
1	Regulations: None
2	Directions: 19
3	Diagrams: 511, 516, 519, 570, 572, 573, 575
4	Permitted variants: None
5	Illumination requirements: Schedule 17, item 1

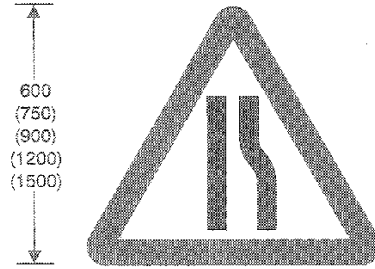

517  
Road narrows on right ahead

Item	
1	Regulations: None
2	Directions: 19
3	Diagrams: 511, 516, 519, 570, 572, 573, 575
4	Permitted variants: Schedule 16, item 28
5	Illumination requirements: Schedule 17, item 1

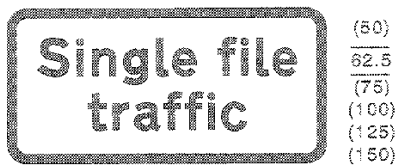

518  
Convergence of traffic to a single file in each direction

Item	
1	Regulations: None
2	Directions: 19
3	Diagrams: 516, 517, 520, 570
4	Permitted variants: None
5	Illumination requirements: Schedule 17, item 8



519  
Road only wide enough for one line of vehicles

Item	
1	Regulations: None
2	Directions: 19
3	Diagrams: 516, 517, 570
4	Permitted variants: None
5	Illumination requirements: Schedule 17, item 8

**Status:** This is the original version (as it was originally made). This item of legislation is currently only available in its original format.

SCHEDULE 1 WARNING SIGNS (contd.)

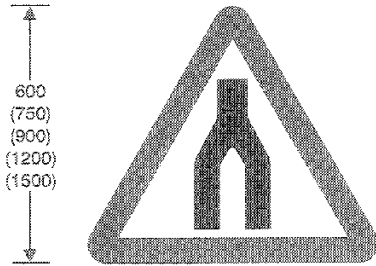

520  
Dual carriageway ends ahead

Item	
1	Regulations: None
2	Directions: 19
3	Diagrams: 511, 518, 572
4	Permitted variants: None
5	Illumination requirements: Schedule 17, item 1

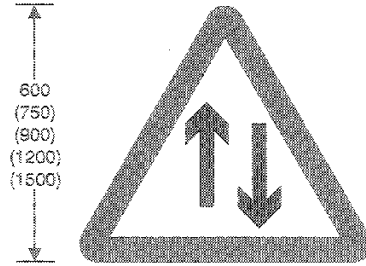

521  
Two-way traffic

Item	
1	Regulations: None
2	Directions: 19
3	Diagrams: 570, 572
4	Permitted variants: None
5	Illumination requirements: Schedule 17, item 1

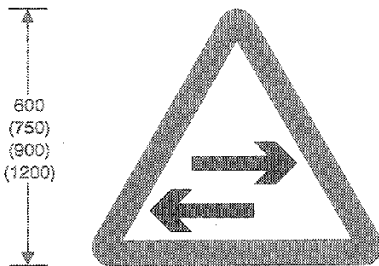

522  
Two-way traffic on route crossing ahead

Item	
1	Regulations: None
2	Directions: 19
3	Diagrams: 572
4	Permitted variants: None
5	Illumination requirements: Schedule 17, item 1

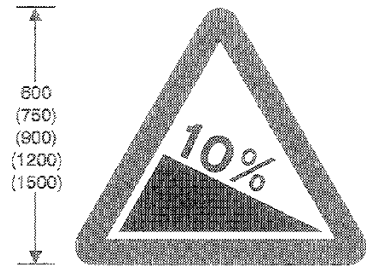

523.1  
Steep hill downwards ahead

Item	
1	Regulations: None
2	Directions: 19
3	Diagrams: 511, 526, 526, 627, 570, 572, 573, 817.2
4	Permitted variants: Schedule 16, item 1
5	Illumination requirements: Schedule 17, item 1

**Status:** This is the original version (as it was originally made). This item of legislation is currently only available in its original format.

SCHEDULE 1 WARNING SIGNS (contd.)

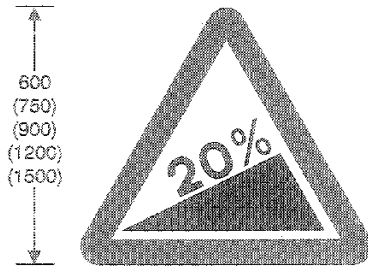

524.1  
Steep hill upwards ahead

Item	
1	Regulations: None
2	Directions: 19
3	Diagrams: 511, 525, 526, 527, 570, 572, 573
4	Permitted variants: Schedule 16, item 1
5	Illumination requirements: Schedule 17, item 1



525  
Drivers should engage low gear for steep hill

Item	
1	Regulations: None
2	Directions: 19
3	Diagrams: 523.1, 524.1
4	Permitted variants: None
5	Illumination requirements: Schedule 17, item 8



526  
Drivers should keep in low gear for steep hill or tight bend

Item	
1	Regulations: None
2	Directions: 19
3	Diagrams: 512, 512.1, 512.2, 513, 523.1, 524.1, 554.1
4	Permitted variants: None
5	Illumination requirements: Schedule 17, item 8

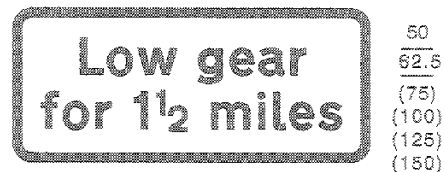

527  
Drivers should keep in low gear for distance indicated

Item	
1	Regulations: None
2	Directions: 19
3	Diagrams: 523.1, 524.1
4	Permitted variants: Schedule 16, item 5
5	Illumination requirements: Schedule 17, item 8

**Status:** This is the original version (as it was originally made). This item of legislation is currently only available in its original format.

SCHEDULE 1 WARNING SIGNS (contd.)

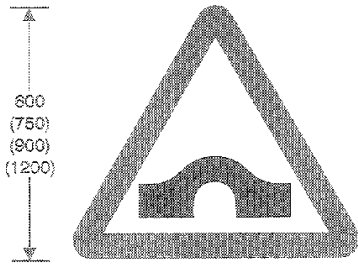

528  
Hump bridge ahead

Item	
1	Regulations: None
2	Directions: 19
3	Diagrams: 511, 572, 573, 575, 762
4	Permitted variants: None
5	Illumination requirements: Schedule 17, item 1

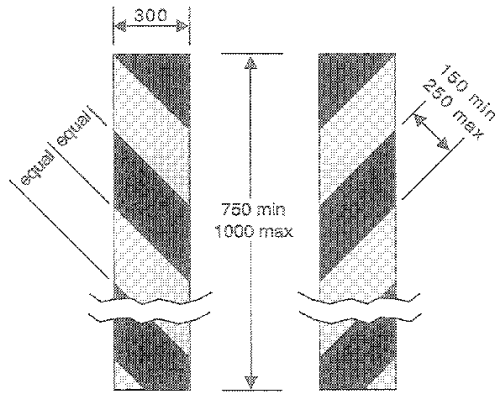

528.1  
End of bridge parapet, abutment wall, tunnel mouth, or other obstruction adjacent to the carriage way

Item	
1	Regulations: None
2	Directions: None
3	Diagrams: None
4	Permitted variants: None
5	Illumination requirements: Schedule 17, item 4 The parts of the sign coloured yellow may be fluorescent as well as retroreflective

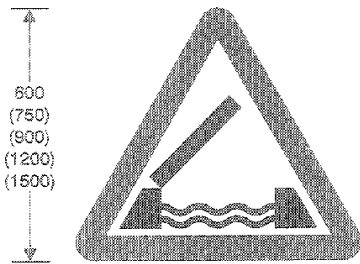

529  
Opening or swing bridge ahead

Item	
1	Regulations: None
2	Directions: 19
3	Diagrams: 572, 573, 773
4	Permitted variants: None
5	Illumination requirements: Schedule 17, item 1

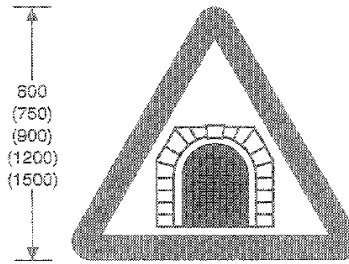

529.1  
Tunnel ahead

Item	
1	Regulations: None
2	Directions: 19
3	Diagrams: 572, 573, 675, 773
4	Permitted variants: None
5	Illumination requirements: Schedule 17, item 1



**Status:** This is the original version (as it was originally made). This item of legislation is currently only available in its original format.

SCHEDULE 1 WARNING SIGNS (contd.)

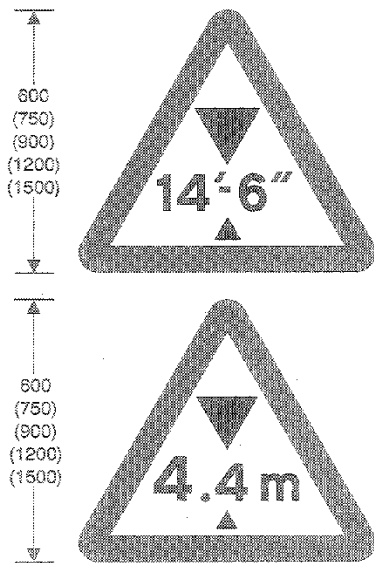

530

Maximum headroom available at hazard

Item	
1	Regulations: None
2	Directions: 19
3	Diagrams: 530.1, 530.2, 572, 573
4	Permitted variants: Schedule 16, item 1 Metric sign may be omitted or placed to the right of the imperial sign
5	Illumination requirements: Schedule 17, item 1



530.1

Reduced headroom over part of road due to overhanging building ahead

Item	
1	Regulations: None
2	Directions: 19
3	Diagrams: 530
4	Permitted variants: None
5	Illumination requirements: Schedule 17, item 6

**Status:** This is the original version (as it was originally made). This item of legislation is currently only available in its original format.

SCHEDULE 1 WARNING SIGNS (contd.)

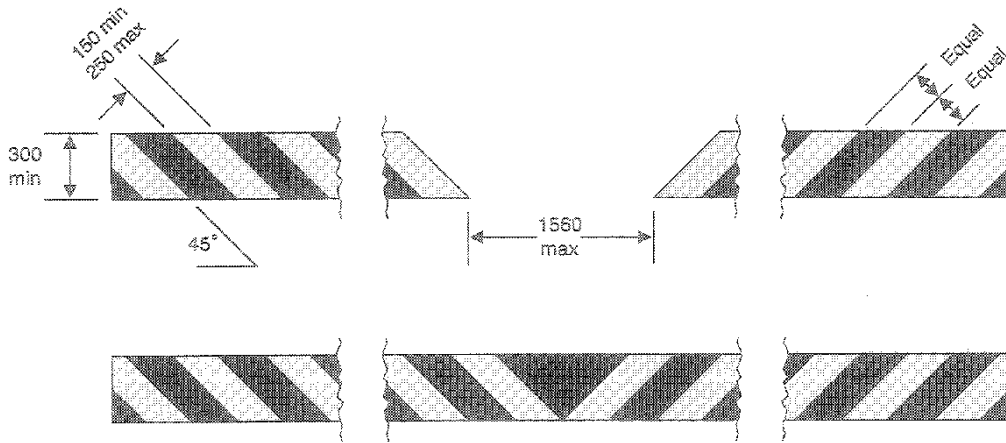

530.2  
Reduced headroom at a hazard  
(Alternative types)

Item	
1	Regulations: None
2	Directions: 19
3	Diagrams: 530, 629.2, 629.2A
4	Permitted variants: None
5	illumination requirements: Schedule 17, item 9 Where those parts of the sign coloured yellow are retroreflective they may also be fluorescent

**Status:** This is the original version (as it was originally made). This item of legislation is currently only available in its original format.

SCHEDULE 1 WARNING SIGNS (contd.)

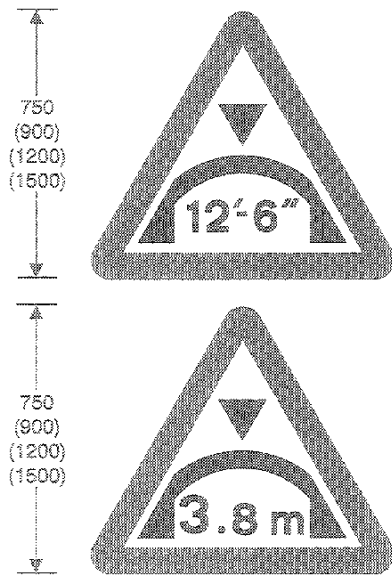

531.1  
Maximum headroom available  
at arch bridge ahead

Item	
1	Regulations: None
2	Directions: 18
3	Diagrams: 531.2, 572, 573
4	Permitted variants: Schedule 16, item 1 Metric sign may be omitted
5	Illumination requirements: Schedule 17, item 1

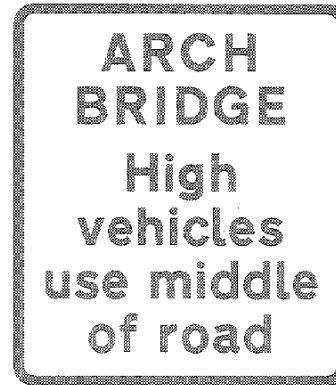

531.2  
High vehicles to use the middle of road  
at arch bridge ahead

Item	
1	Regulations: None
2	Directions: 18
3	Diagrams: 531.1
4	Permitted variants: None
5	Illumination requirements: Schedule 17, item 8

**Status:** This is the original version (as it was originally made). This item of legislation is currently only available in its original format.

SCHEDULE 1 WARNING SIGNS (contd.)

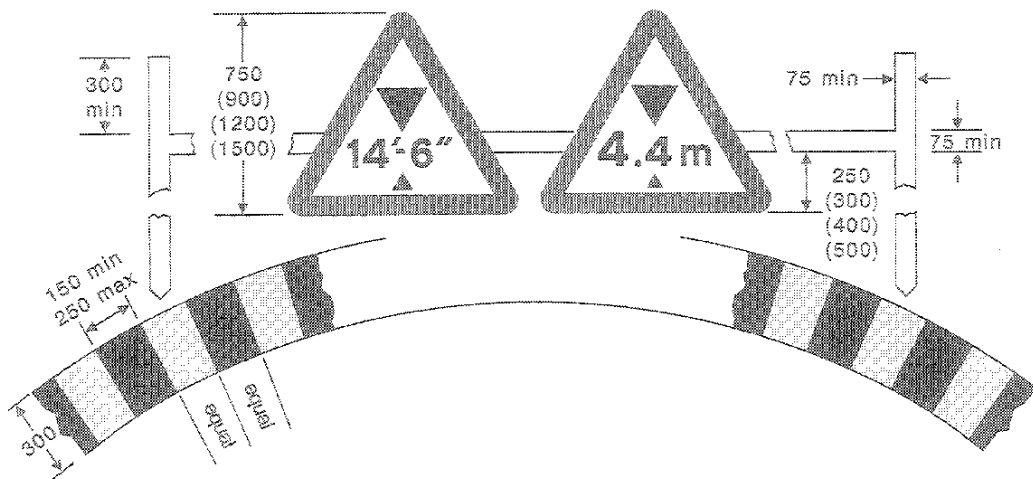

532.2  
Maximum headroom available in the centre of a road at an arch bridge

Item:	
1	Regulations: None
2	Directions: None
3	Diagrams: None
4	Permitted variants: Schedule 16, item 1 Black and yellow markings may be omitted. Metric sign may be omitted
5	Illumination requirements: Schedule 17, items 1, & Same as diagram 530.2

**Status:** This is the original version (as it was originally made). This item of legislation is currently only available in its original format.

SCHEDULE 1 WARNING SIGNS (contd.)

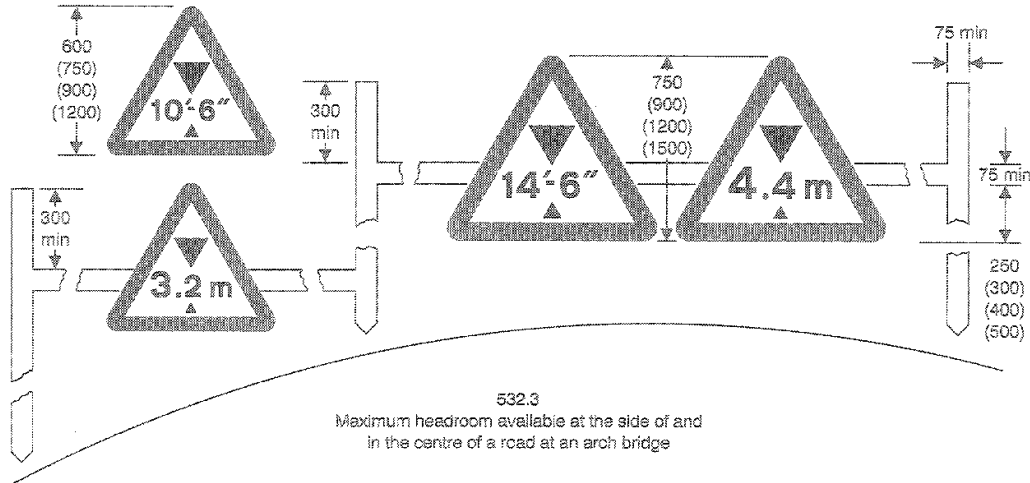

Item	
1	Regulations: None
2	Directions: None
3	Diagrams: None
4	Permitted variants: Schedule 16, item 1 Metric signs may be omitted. Black and yellow markings shown in diagram 532.2 may be added
5	Illumination requirements: Schedule 17, items 1, 9

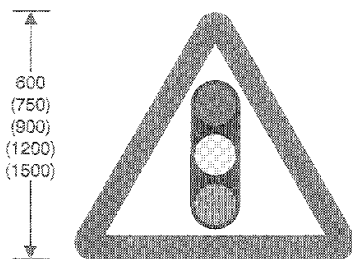

543  
Traffic signals ahead

Item	
1	Regulations: None
2	Directions: 19
3	Diagrams: 543.1, 547.6, 572, 573
4	Permitted variants: None
5	Illumination requirements: Schedule 17, items 1, 5

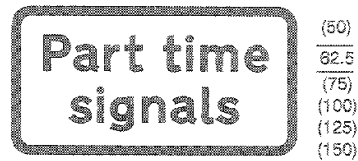

543.1  
Traffic signals ahead which only operate at certain times

Item	
1	Regulations: None
2	Directions: 19
3	Diagrams: 543, 3000, 3000.3, 3000.4, 3000.5, 3000.6
4	Permitted variants: "Part time" may be varied to "Peak hour"
5	Illumination requirements: Schedule 17, item 8

**Status:** This is the original version (as it was originally made). This item of legislation is currently only available in its original format.

SCHEDULE 1 WARNING SIGNS (contd.)

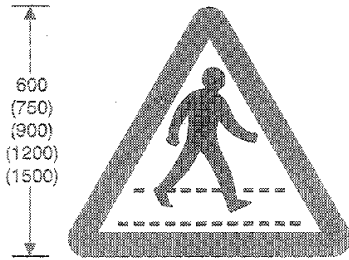

544  
Pedestrian crossing ahead

Item	
1	Regulations: None
2	Directions: 19
3	Diagrams: 547.5, 572, 573
4	Permitted variants: None
5	Illumination requirements: Schedule 17, items 1, 5

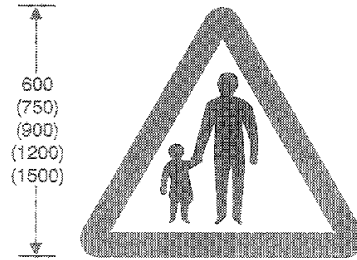

544.1  
Pedestrians in road ahead

Item	
1	Regulations: None
2	Directions: 19
3	Diagrams: 547.3, 572, 573
4	Permitted variants: None
5	Illumination requirements: Schedule 17, item 1

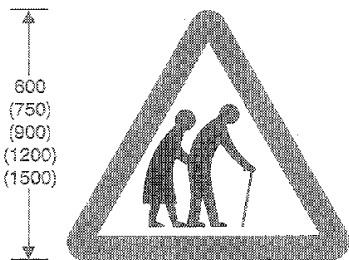

544.2  
Elderly or disabled pedestrians likely to cross road ahead

Item	
1	Regulations: None
2	Directions: 18, 19
3	Diagrams: 547.4, 572, 573
4	Permitted variants: None
5	Illumination requirements: Schedule 17, item 1

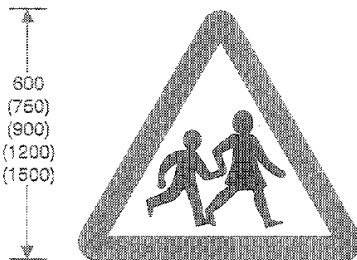

545  
Children going to or from school or playground ahead

Item	
1	Regulations: None
2	Directions: 18(2), 19, 25, 49(1)
3	Diagrams: 546, 547.1, 547.2, 547.3, 547.7, 572, 573, 4004
4	Permitted variants: None
5	Illumination requirements: Schedule 17, item 1

**Status:** This is the original version (as it was originally made). This item of legislation is currently only available in its original format.

SCHEDULE 1 WARNING SIGNS (contd.)



(50)  
62.5  
 (75)  
 (100)  
 (125)  
 (150)

546  
School ahead

Item	
1	Regulations: None
2	Directions: 18(2), 19, 25, 48(1)
3	Diagrams: 545, 4004
4	Permitted variants: None
5	Illumination requirements: Schedule 17, Item 8



(62.5)  
75  
 (100)  
 (125)  
 (150)

547.1  
School crossing patrol ahead

Item	
1	Regulations: None
2	Directions: 18(2), 19, 25, 48(1)
3	Diagrams: 545, 4004
4	Permitted variants: None
5	Illumination requirements: Schedule 17, Item 8



(50)  
62.5  
 (75)  
 (100)  
 (125)  
 (150)

547.2  
Children's playground ahead

Item	
1	Regulations: None
2	Directions: 18(2), 19
3	Diagrams: 545
4	Permitted variants: None
5	Illumination requirements: Schedule 17, Item 8

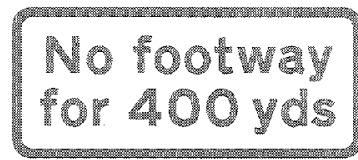

(50)  
62.5  
 (75)  
 (100)  
 (125)  
 (150)

547.3  
No footway for distance indicated

Item	
1	Regulations: None
2	Directions: 18(2), 19
3	Diagrams: 544.1, 545
4	Permitted variants: Schedule 16, Item 6
5	Illumination requirements: Schedule 17, Item 8

**Status:** This is the original version (as it was originally made). This item of legislation is currently only available in its original format.

SCHEDULE 1 WARNING SIGNS (contd.)



547.4  
Elderly pedestrians  
likely to cross road ahead

Item	
1	Regulations: None
2	Directions: 18, 19
3	Diagrams: 544.2
4	Permitted variants: "Elderly" may be varied to "Blind" or "Disabled"
5	Illumination requirements: Schedule 17, item 8

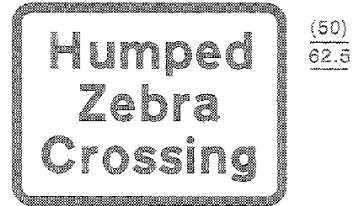

547.5  
Zebra pedestrian crossing on road hump ahead

Item	
1	Regulations: None
2	Directions: 19
3	Diagrams: 544
4	Permitted variants: None
5	Illumination requirements: Schedule 17, item 8



547.6  
Pelican pedestrian crossing on road hump ahead

Item	
1	Regulations: None
2	Directions: 19
3	Diagrams: 543
4	Permitted variants: None
5	Illumination requirements: Schedule 17, item 8



547.7  
Disabled children likely  
to cross road ahead

Item	
1	Regulations: None
2	Directions: 18(2), 19
3	Diagrams: 545
4	Permitted variants: "Disabled" may be varied to "Blind" or "Deaf"
5	Illumination requirements: Schedule 17, item 8



**Status:** This is the original version (as it was originally made). This item of legislation is currently only available in its original format.

SCHEDULE 1 WARNING SIGNS (contd.)

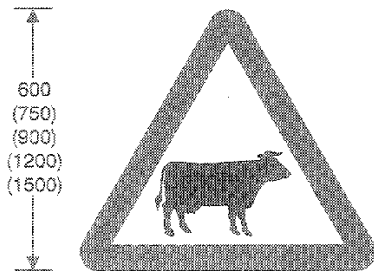

548  
Cattle likely to be in road ahead

item	
1	Regulations: None
2	Directions: 19, 48(2)
3	Diagrams: 548.1, 570, 4005
4	Permitted variants: None
5	Illumination requirements: Schedule 17, item 4

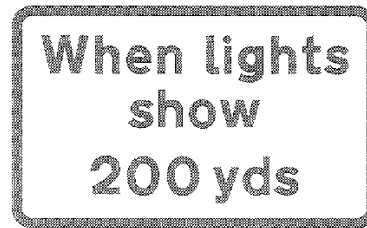

548.1  
Supervised cattle crossing ahead

item	
1	Regulations: None
2	Directions: 19, 48(2)
3	Diagrams: 648
4	Permitted variants: Schedule 16, item 6
5	Illumination requirements: Schedule 17, item 8

(50)  
82.5  
(75)  
(100)  
(125)  
(150)

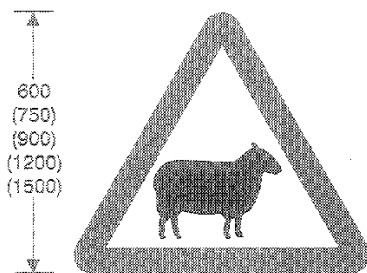

549  
Sheep likely to be in road ahead

item	
1	Regulations: None
2	Directions: 19
3	Diagrams: 570
4	Permitted variants: None
5	Illumination requirements: Schedule 17, item 4

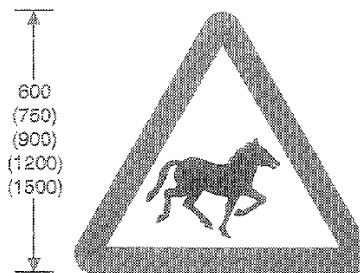

550  
Wild horses or ponies likely to be in road ahead

item	
1	Regulations: None
2	Directions: 19
3	Diagrams: 570
4	Permitted variants: None
5	Illumination requirements: Schedule 17, item 4

**Status:** This is the original version (as it was originally made). This item of legislation is currently only available in its original format.

SCHEDULE 1 WARNING SIGNS (contd.)

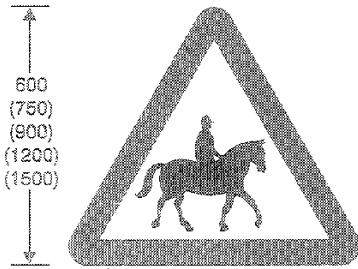

550.1  
Accompanied horses or ponies likely to be in road ahead

Item	
1	Regulations: None
2	Directions: 19
3	Diagrams: 570
4	Permitted variants: None
5	Illumination requirements: Schedule 17, item 4

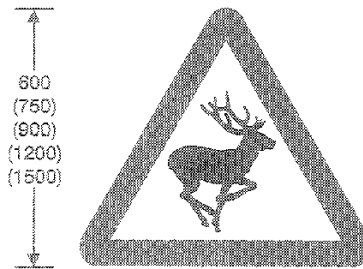

551  
Wild animals likely to be in road ahead

Item	
1	Regulations: None
2	Directions: 19
3	Diagrams: 570
4	Permitted variants: None
5	Illumination requirements: Schedule 17, item 4

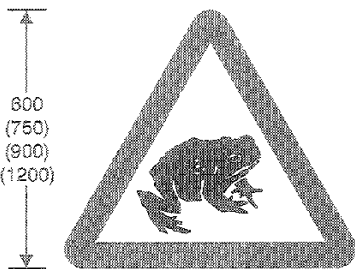

551.1  
Migratory toad crossing ahead

Item	
1	Regulations: None
2	Directions: 19, 26
3	Diagrams: 570
4	Permitted variants: None
5	Illumination requirements: Schedule 17, item 4

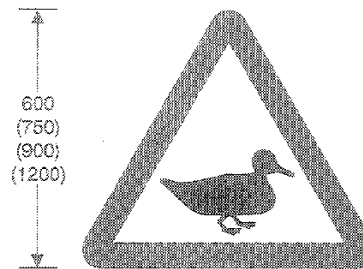

551.2  
Wild fowl likely to be in road ahead

Item	
1	Regulations: None
2	Directions: None
3	Diagrams: 570
4	Permitted variants: None
5	Illumination requirements: Schedule 17, item 4

**Status:** This is the original version (as it was originally made). This item of legislation is currently only available in its original format.

SCHEDULE 1 WARNING SIGNS (contd.)

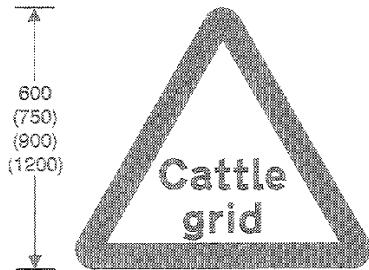

552  
Cattle grid ahead

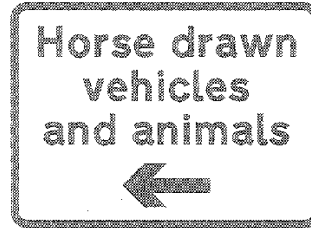

553  
By-pass of cattle grid

50  
(62.5)  
(75)  
(100)

Item	
1	Regulations: None
2	Directions: 19
3	Diagrams: 553, 572, 573
4	Permitted variants: None
5	Illumination requirements: Schedule 17, item 4

Item	
1	Regulations: None
2	Directions: 19
3	Diagrams: 552
4	Permitted variants: Schedule 18, item 13
5	Illumination requirements: Schedule 17, item 8

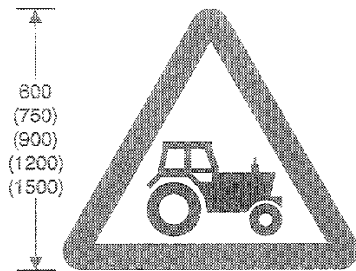

553.1  
Agricultural vehicles likely to be in road ahead

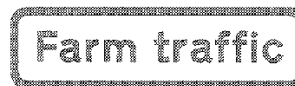

553.2  
Agricultural vehicles likely to be in road ahead

50  
(62.5)  
(75)  
(100)  
(125)  
(150)

Item	
1	Regulations: None
2	Directions: 18, 19
3	Diagrams: 553.2, 570
4	Permitted variants: None
5	Illumination requirements: Schedule 17, item 4

Item	
1	Regulations: None
2	Directions: 18, 19
3	Diagrams: 553.1
4	Permitted variants: "Farm traffic" may be varied to "Wide vehicles" or "Tractors turning"
5	Illumination requirements: Schedule 17, item 8

**Status:** This is the original version (as it was originally made). This item of legislation is currently only available in its original format.

SCHEDULE 1 WARNING SIGNS (contd.)

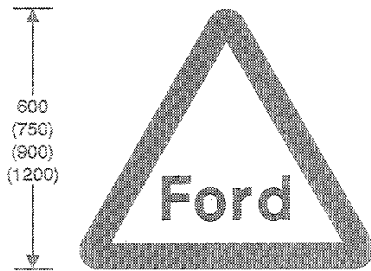

554  
Worded warning sign

Item	
1	Regulations: None
2	Directions: 19, 34(3)
3	Diagrams: 572, 573
4	Permitted variants: "Ford" may be varied to "Flood", "Gate", or "No smoking"
5	Illumination requirements: Schedule 17, Item 4

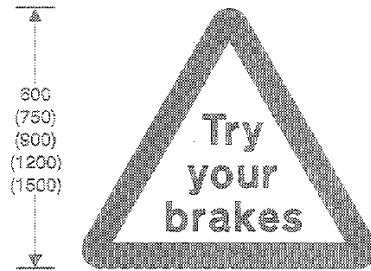

554.1  
Risk of brake failure after crossing a ford or before descending a steep gradient

Item	
1	Regulations: None
2	Directions: 19
3	Diagrams: 526, 817.2
4	Permitted variants: None
5	Illumination requirements: Schedule 17, Item 4

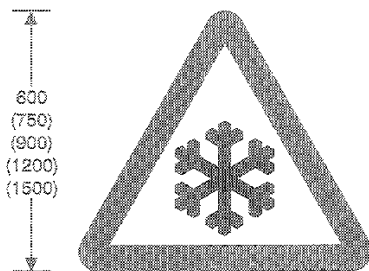

554.2  
Risk of ice or packed snow ahead

Item	
1	Regulations: None
2	Directions: 18, 19, 34(3)
3	Diagrams: 554.3, 570
4	Permitted variants: None
5	Illumination requirements: Schedule 17, Item 4

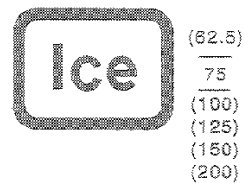

554.3  
Ice ahead

Item	
1	Regulations: None
2	Directions: 18, 19, 34(3)
3	Diagrams: 554.2, 622.1A, 622.4, 629, 629.1, 632
4	Permitted variants: "Ice" may be varied to "Snowdrifts"
5	Illumination requirements: Schedule 17, Item 8

**Status:** This is the original version (as it was originally made). This item of legislation is currently only available in its original format.

SCHEDULE 1 WARNING SIGNS (contd.)

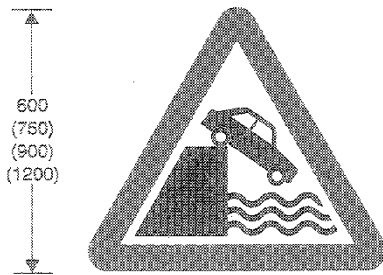

555  
Quayside or river bank ahead

Item	
1	Regulations: None
2	Directions: 19
3	Diagrams: 572, 573
4	Permitted variants: None
5	Illumination requirements: Schedule 17, item 1

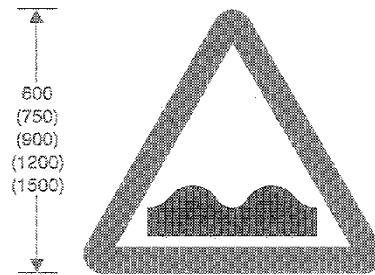

556  
Uneven road ahead

Item	
1	Regulations: None
2	Directions: 19
3	Diagrams: 511, 570
4	Permitted variants: None
5	Illumination requirements: Schedule 17, item 4

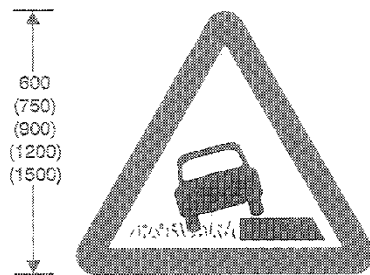

556.1  
Soft verges ahead

Item	
1	Regulations: None
2	Directions: 18, 19
3	Diagrams: 556.2, 570
4	Permitted variants: None
5	Illumination requirements: Schedule 17, item 4

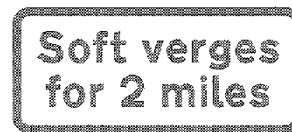

50  
(62.5)  
(75)  
(100)  
(125)  
(150)

556.2  
Soft verges for distance indicated

Item	
1	Regulations: None
2	Directions: 18, 19
3	Diagrams: 556.1
4	Permitted variants: Schedule 16 items 6, 9
5	Illumination requirements: Schedule 17, item 8

*Status: This is the original version (as it was originally made). This item of legislation is currently only available in its original format.*

SCHEDULE 1 WARNING SIGNS (contd.)

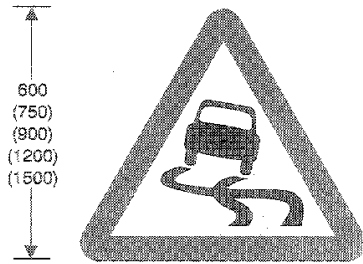

557  
Slippery road ahead

Item	
1	Regulations: None
2	Directions: 19
3	Diagrams: 570
4	Permitted variants: None
5	Illumination requirements: Schedule 17, item 4

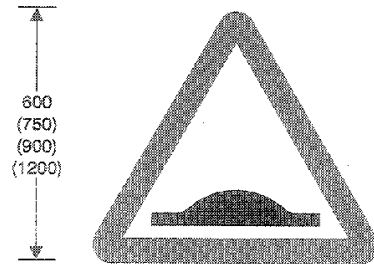

557.1  
Road hump or series of road humps ahead

Item	
1	Regulations: None
2	Directions: 15, 16, 18, 19
3	Diagrams: 557.2, 557.3, 557.4, 1060, 1060.1, 1061, 1061.1
4	Permitted variants: None
5	Illumination requirements: Schedule 17, item 5



557.2  
Road humps ahead for the distance indicated

Item	
1	Regulations: None
2	Directions: 18, 19
3	Diagrams: 557.1
4	Permitted variants: Schedule 16, item 6
5	Illumination requirements: Schedule 17, item 8

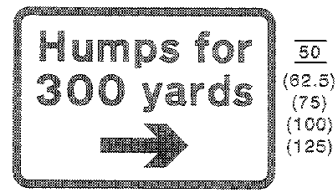

557.3  
Road humps ahead in the direction and for the distance indicated

Item	
1	Regulations: None
2	Directions: 18, 19
3	Diagrams: 557.1
4	Permitted variants: Schedule 16, items 6, 13
5	Illumination requirements: Schedule 17, item 8

**Status:** This is the original version (as it was originally made). This item of legislation is currently only available in its original format.

SCHEDULE 1 WARNING SIGNS (contd.)

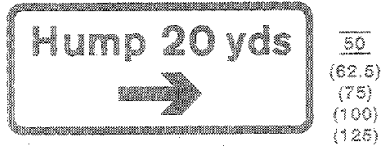

557.4  
Road hump in the direction and at the distance indicated

Item	
1	Regulations: None
2	Directions: 18, 19
3	Diagrams: 557.1
4	Permitted variants: Schedule 16, items 8, 13, 14
5	Illumination requirements: Schedule 17, item 6

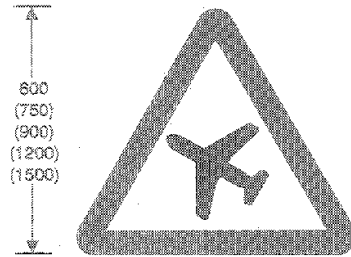

558  
Low flying aircraft or sudden aircraft noise likely ahead

Item	
1	Regulations: None
2	Directions: 19
3	Diagrams: 558.2, 570, 773
4	Permitted variants: None
5	Illumination requirements: Schedule 17, item 4

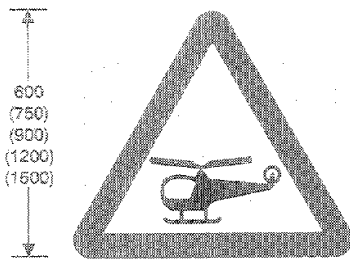

558.1  
Low flying helicopters or sudden helicopter noise likely ahead

Item	
1	Regulations: None
2	Directions: 19
3	Diagrams: 570
4	Permitted variants: None
5	Illumination requirements: Schedule 17, item 4



558.2  
Gliders likely ahead

Item	
1	Regulations: None
2	Directions: 19
3	Diagrams: 558
4	Permitted variants: None
5	Illumination requirements: Schedule 17, item 3

Status: This is the original version (as it was originally made). This item of legislation is currently only available in its original format.

SCHEDULE 1 WARNING SIGNS (contd.)

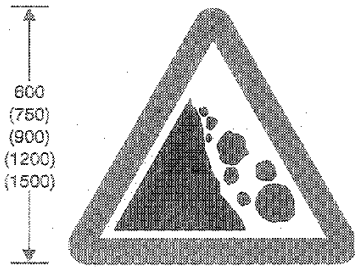

559  
Risk of falling or fallen rocks ahead

Item	
1	Regulations: None
2	Directions: 19
3	Diagrams: 570
4	Permitted variants: Schedule 16, item 25
5	Illumination requirements: Schedule 17, item 4

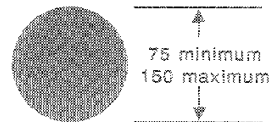

560  
Edge of carriageway or obstruction  
near that edge

Item	
1	Regulations: 21, 44(2)
2	Directions: 39
3	Diagrams: None
4	Permitted variants: The portion of the sign coloured red may be varied to white or amber
5	Illumination requirements: Schedule 17, item 13

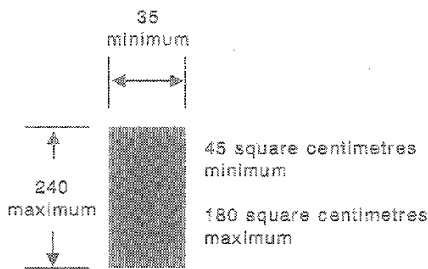

561  
Alternative shape for the sign shown  
in diagram 560

Item	
1	Regulations: 21, 44(2)
2	Directions: 39
3	Diagrams: None
4	Permitted variants: Same as diagram 560 The surface of the sign may be curved
5	Illumination requirements: Schedule 17, item 13

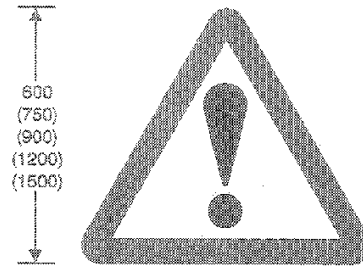

562  
Other danger ahead

Item	
1	Regulations: 42(1)
2	Directions: 18, 19, 34(3)
3	Diagrams: 563, 563.1, 572, 573, 7022
4	Permitted variants: None
5	Illumination requirements: Schedule 17, item 4



**Status:** This is the original version (as it was originally made). This item of legislation is currently only available in its original format.

SCHEDULE 1 WARNING SIGNS (contd.)



563  
Nature of other danger ahead

Item	
1	Regulations: None
2	Directions: 18, 19, 34(3)
3	Diagrams: 562
4	Permitted variants: "Accident" may be varied to: 1. "Ambulance station" 2. "Blasting" 3. "Blind summit" 4. "Census" 5. "Dust cloud" 6. "Fallen tree" 7. "Fire station" 8. "Frost damage" 9. "Hidden dip" 10. "Overhead cable repairs" 11. "Road liable to flooding" 12. "Smoke"
5	Illumination requirements: Schedule 17, item 8

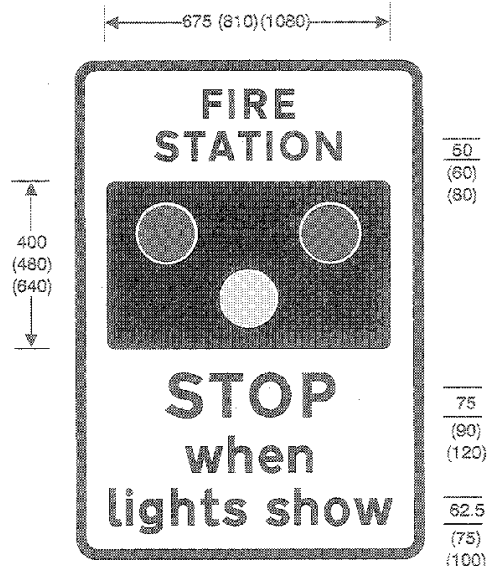

563.1  
Warning of light signals as shown in diagram 3014 ahead

Item	
1	Regulations: None
2	Directions: 18, 19
3	Diagrams: 562
4	Permitted variants: "FIRE" may be varied to "AMBULANCE"
5	Illumination requirements: Schedule 17, item 8

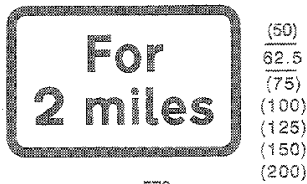

570  
Distance over which hazard or prohibition extends

Item	
1	Regulations: None
2	Directions: 19
3	Diagrams: 513, 516 or 517 when used with 518 or 519, 521, 523.1, 524.1, 548, 549, 550, 550.1, 551, 551.1, 551.2, 553.1, 554.2, 556, 558.1, 557, 558, 558.1, 559, 581, 582, 614, 615, 632, 642, 611, 7001, 7009
4	Permitted variants: Schedule 16 item 6
5	Illumination requirements: Schedule 17, item 8

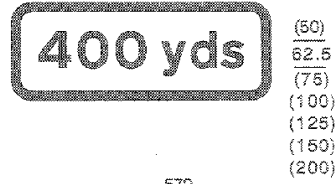

572  
Distance ahead to hazard

Item	
1	Regulations: None
2	Directions: 19
3	Diagrams: 504.1, 505.1, 506.1, 507.1, 516, 517, 520, 521, 522, 523.1, 524.1, 526, 529, 529.1, 530, 531.1, 543, 544, 544.1, 544.2, 545, 552, 554, 555, 562, 770, 771, 772, 782, 950, 7001, 7009
4	Permitted variants: Schedule 16 item 6
5	Illumination requirements: Schedule 17, item 8

**Status:** This is the original version (as it was originally made). This item of legislation is currently only available in its original format.

SCHEDULE 1 WARNING SIGNS (contd.)

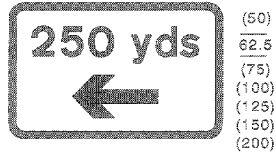

(50)  
62.5  
(75)  
(100)  
(125)  
(150)  
(200)

573  
Distance and direction to hazard

Item	
1	Regulations: None
2	Directions: 19
3	Diagrams: 513, 517, 523.1, 524.1, 528, 529, 529.1, 530, 531.1, 543, 544, 544.1, 544.2, 545, 552, 554, 555, 562, 770, 771, 772, 782, 950, 7001, 7003
4	Permitted variants: Schedule 16 items 6, 9, 13
5	Illumination requirements: Schedule 17, item 6

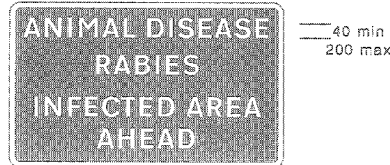

574  
Area infected by animal diseases

Item	
1	Regulations: None
2	Directions: 27
3	Diagrams: None
4	Permitted variants: "RABIES" may be omitted or varied to any appropriate animal disease name on one or two lines. "AHEAD" may be omitted or varied to "ENDS" or a horizontal arrow pointing left or right
5	Illumination requirements: Schedule 17, item 4

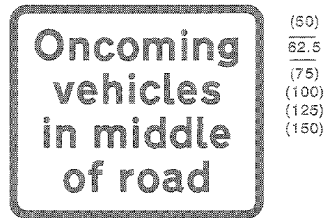

(50)  
62.5  
(75)  
(100)  
(125)  
(150)

575  
Large vehicles likely to be in middle of road because of narrowness of carriageway

Item	
1	Regulations: None
2	Directions: 19
3	Diagrams: 516, 517, 528, 529.1
4	Permitted variants: None
5	Illumination requirements: Schedule 17, item 6

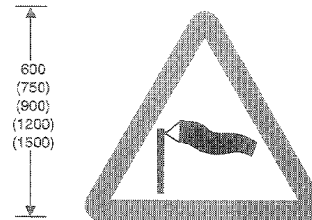

581  
Side winds likely ahead

Item	
1	Regulations: None
2	Directions: 19
3	Diagrams: 570
4	Permitted variants: None
5	Illumination requirements: Schedule 17, item 4

**Status:** This is the original version (as it was originally made). This item of legislation is currently only available in its original format.

SCHEDULE 1 WARNING SIGNS (contd.)

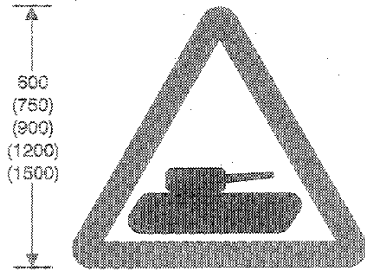

582  
Slow moving military vehicles likely to be crossing or in road ahead

Item	
1	Regulations: None
2	Directions: 19
3	Diagrams: 670
4	Permitted variants: None
5	Illumination requirements: Schedule 17, item 4

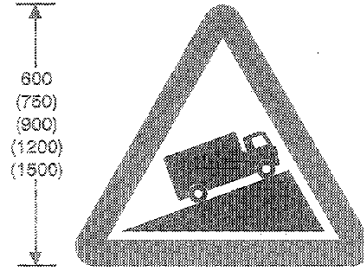

583  
Slow moving vehicles likely on incline ahead

Item	
1	Regulations: None
2	Directions: 18, 19
3	Diagrams: 583.1
4	Permitted variants: None
5	Illumination requirements: Schedule 17, item 4

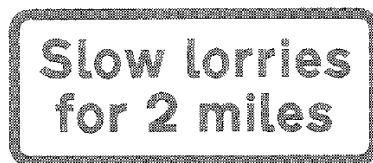

(50)  
62.5  
(75)  
(100)  
(125)  
(150)  
(200)

583.1  
Distance over which slow moving vehicles likely to be encountered ahead

Item	
1	Regulations: None
2	Directions: 18, 19
3	Diagrams: 583
4	Permitted variants: Schedule 16 item 5
5	Illumination requirements: Schedule 17, item 2

**Status:** This is the original version (as it was originally made). This item of legislation is currently only available in its original format.

## SCHEDULE 2

Regulation 11(1)

### REGULATORY SIGNS

(other than those for railway and tramway level crossings, bus and pedal cycle facilities, and road works)

**Status:** This is the original version (as it was originally made). This item of legislation is currently only available in its original format.

SCHEDULE 2

Regulation 11(1)

REGULATORY SIGNS

(other than those for railway and tramway level crossings, bus and pedal cycle facilities, and road works)

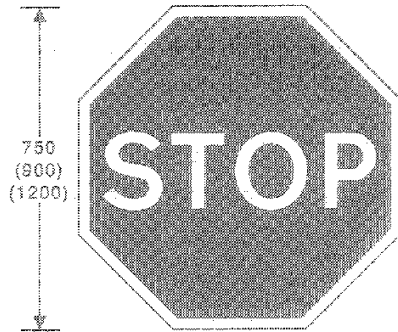

601.1

Vehicular traffic must comply with the requirements prescribed in regulation 16

Item	
1	Regulations: 4, 10(1), 10(2), 16
2	Directions: 6, 15, 16, 18, 19
3	Diagrams: 608, 1002.1, 1022
4	Permitted variants: None
5	Illumination requirements: Schedule 17, item 1

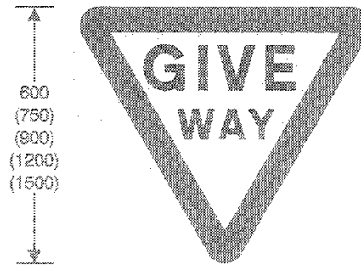

602

Vehicular traffic must comply with the requirements prescribed in regulation 16

Item	
1	Regulations: 4, 10(1), 16, 25(2), 25(3)
2	Directions: 15, 16, 19
3	Diagrams: 608, 611.1, 774, 775, 778.1, 1003, 1003.4, 1023
4	Permitted variants: None
5	Illumination requirements: Schedule 17, item 1

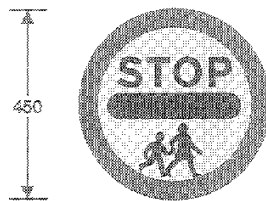

605.2

Vehicular traffic must comply with the requirements of section 28 of the 1984 Act when the sign is exhibited by a school crossing patrol

Item	
1	Regulations: 19(4), 35(1)
2	Directions: 36
3	Diagrams: None
4	Permitted variants: None
5	Illumination requirements: Schedule 17, item 15

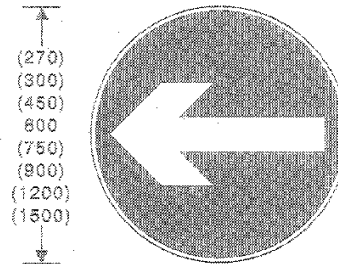

606

Vehicular traffic must proceed in the direction indicated by the arrow

Item	
1	Regulations: 10(1), 12(7), 37(2), 42
2	Directions: 7, 16(3), 19
3	Diagrams: 515, 515.1A, 515.2, 607, 608, 954, 954.1, 954.2, 954.3, 954.4
4	Permitted variants: Schedule 16, item 13
5	Illumination requirements: Schedule 17, items 1, 6, 7

*Status: This is the original version (as it was originally made). This item of legislation is currently only available in its original format.*

SCHEDULE 2 REGULATORY SIGNS (contd.)



(50)  
92.5  
 (75)  
 (100)  
 (125)

607  
One way traffic

Item	
1	Regulations: 12(7)
2	Directions: 7, 19
3	Diagrams: 608, 609
4	Permitted variants: None
5	Illumination requirements: Schedule 17, item 8



(50)  
62.5  
 (75)  
 (100)  
 (125)

608  
Dual carriageway

Item	
1	Regulations: None
2	Directions: 7, 19
3	Diagrams: 501, 601.1, 602, 606, 609, 610
4	Permitted variants: None
5	Illumination requirements: Schedule 17, item 8

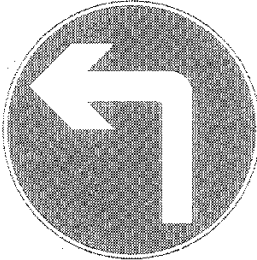

(450)  
 600  
 (750)  
 (900)  
 (1200)

609  
Vehicular traffic must turn ahead in the direction indicated by the arrow

Item	
1	Regulations: 12(7), 42
2	Directions: 7, 19
3	Diagrams: 607, 608, 954, 954.1, 954.2, 954.3, 954.4
4	Permitted variants: Schedule 16, item 28
5	Illumination requirements: Schedule 17, item 1

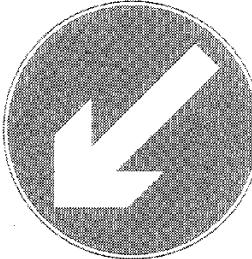

(270)  
 (450)  
 600  
 (750)  
 (900)  
 (1200)  
 (1500)

610  
Vehicular traffic must comply with the requirements of regulation 15

Item	
1	Regulations: 10(1), 12(7), 14, 15, 26(4), 42
2	Directions: 19
3	Diagrams: 606
4	Permitted variants: Arrow may point downwards to the right
5	Illumination requirements: Schedule 17, items 1, 7

**Status:** This is the original version (as it was originally made). This item of legislation is currently only available in its original format.

SCHEDULE 2 REGULATORY SIGNS (contd.)

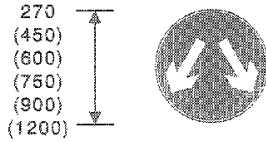

611  
Vehicular traffic may reach the same destination by proceeding either side of the sign

Item	
1	Regulations: 12(7)
2	Directions: None
3	Diagrams: None
4	Permitted variants: None
5	Illumination requirements: Schedule 17, items 1, 7

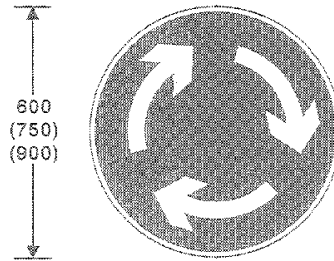

611.1  
Vehicular traffic entering the junction must give priority to vehicles from the right at the transverse road marking shown in diagram 1003.3 associated with the sign (or, if the line is not for the time being visible, at the road junction) and proceed past the marking shown in diagram 1003.4 in the direction indicated by the arrows

Item	
1	Regulations: 10(1),12(7)
2	Directions: 15, 16
3	Diagrams: 602, 1003, 1003.3, 1003.4, 1023
4	Permitted variants: None
5	Illumination requirements: Schedule 17, item 1

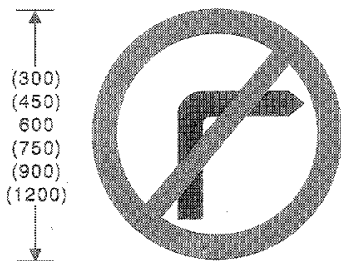

612  
No right turn for vehicular traffic

Item	
1	Regulations: 12(7), 37(2)
2	Directions: 7, 19
3	Diagrams: 954, 954.1, 954.2, 954.3, 954.4
4	Permitted variants: None
5	Illumination requirements: Schedule 17, items 1, 6

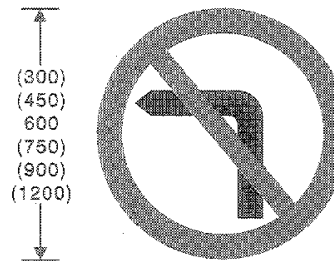

613  
No left turn for vehicular traffic

Item	
1	Regulations: 12(7), 37(2)
2	Directions: 7, 19
3	Diagrams: 954, 954.1, 954.2, 954.3, 954.4
4	Permitted variants: None
5	Illumination requirements: Schedule 17, items 1, 6

**Status:** This is the original version (as it was originally made). This item of legislation is currently only available in its original format.

SCHEDULE 2 REGULATORY SIGNS (contd.)

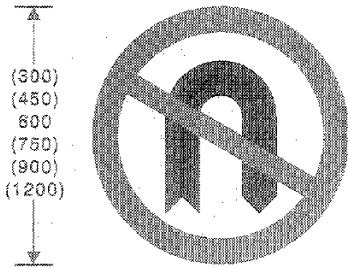

614  
No U-turns for vehicular traffic

Item	
1	Regulations: 10(1), 12(7)
2	Directions: 7, 10, 19
3	Diagrams: 570, 645
4	Permitted variants: None
5	Illumination requirements: Schedule 17, items 1, 6

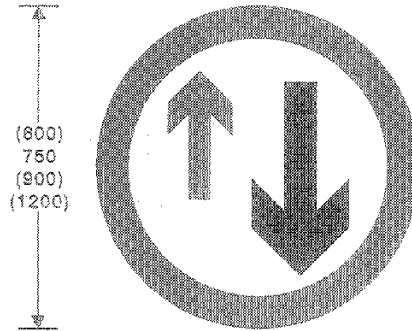

615  
Priority must be given to vehicles from the opposite direction

Item	
1	Regulations: None
2	Directions: 17, 18, 19
3	Diagrams: 570, 615.1, 645, 811, 1003, 1043, 1044
4	Permitted variants: None
5	Illumination requirements: Schedule 17, item 1



615.1  
Same as diagram 615

Item	
1	Regulations: None
2	Directions: 18, 19
3	Diagrams: 615
4	Permitted variants: None
5	Illumination requirements: Schedule 17, item 8

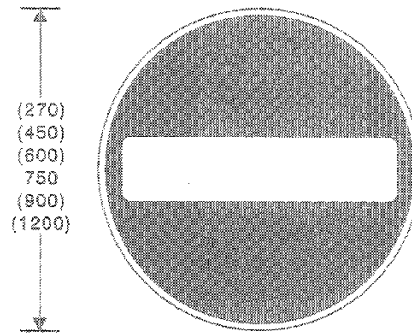

616  
No entry for vehicular traffic

Item	
1	Regulations: 10(1), 10(2), 12(7), 37(2), 42
2	Directions: 7, 8, 19
3	Diagrams: 954, 954.1, 954.2, 1046
4	Permitted variants: None
5	Illumination requirements: Schedule 17, items 1, 7



**Status:** This is the original version (as it was originally made). This item of legislation is currently only available in its original format.

SCHEDULE 2 REGULATORY SIGNS (contd.)

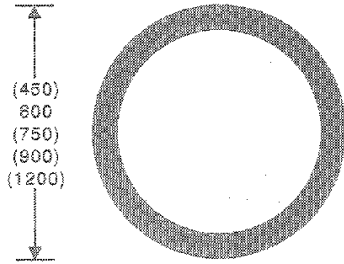

617  
All vehicles prohibited except non-mechanically propelled vehicles being pushed by pedestrians

Item	
1	Regulations: None
2	Directions: 7, 8, 18, 19
3	Diagrams: 618, 618.1
4	Permitted variants: None
5	Illumination requirements: Schedule 17, items 1, 8

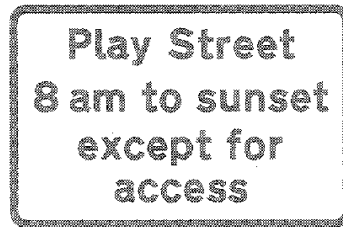

(37.5)  
50  
(82.5)

618  
All vehicles prohibited from "Play Street" during the times indicated except for access

Item	
1	Regulations: None
2	Directions: 7, 8, 18, 19
3	Diagrams: 617, 1046
4	Permitted variants: Schedule 16, item 37
5	Illumination requirements: Schedule 17, item 8

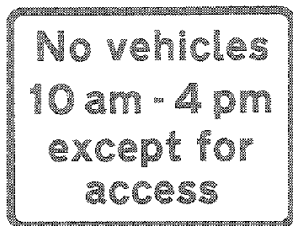

(37.5)  
50  
(62.5)  
(75)  
(100)

618.1  
All vehicles prohibited during the times indicated except for access

Item	
1	Regulations: 22
2	Directions: 7, 8, 18, 19
3	Diagrams: 617
4	Permitted variants: Schedule 16, item 37 The reference to times may be omitted. "except for access" may be omitted; "for access" may be varied to: 1. "for loading" 2. "for loading by" with the goods vehicle symbol shown in diagram 618.2 3. "permit holders" 4. the orange badge symbol shown in diagram 661 5. "buses" 6. "local buses" 7. "buses and coaches" 8. "taxis" 9. "access to off-street premises" These variants may be used in combination with each other and with "except for access", except that 1 and 2 shall not be used together or with "except for access". 9 shall not be used with "except for access", and 5, 6, 7 shall not be used together. The word "and" shall be inserted before the last variant where more than one is used.
5	Illumination requirements: Schedule 17, item 8

Status: This is the original version (as it was originally made). This item of legislation is currently only available in its original format.

SCHEDULE 2 REGULATORY SIGNS (contd.)

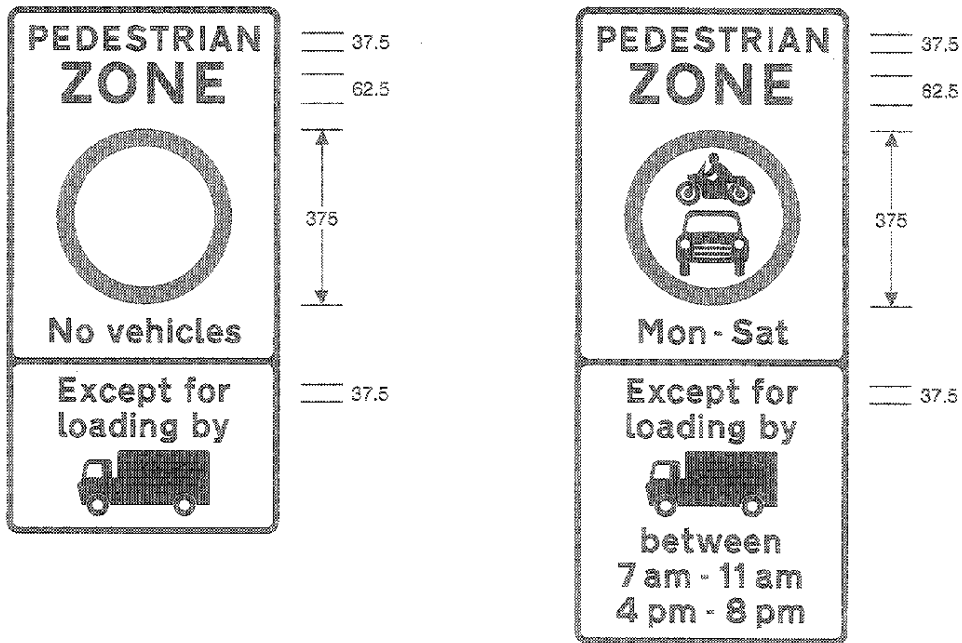

616.2  
Entry to pedestrian zone restricted  
(Alternative types)

Item	
1	Regulations: 22
2	Directions: 7, 8, 22(2)
3	Diagrams: 616.4, 637.2
4	Permitted variants: Schedule 16, items 37, 38 "loading by" with the goods vehicle symbol may be varied to: 1. "local buses" 2. "buses" 3. the orange badge symbol shown in diagram 661 These variants may be used in any combination with each other and with "Except for loading by" with the goods vehicle symbol except that 1 and 2 shall not be used together. The word "and" shall be inserted before the last variant where more than one is used.
5	Illumination requirements: Schedule 17, item 1

**Status:** This is the original version (as it was originally made). This item of legislation is currently only available in its original format.

SCHEDULE 2 REGULATORY SIGNS (contd.)

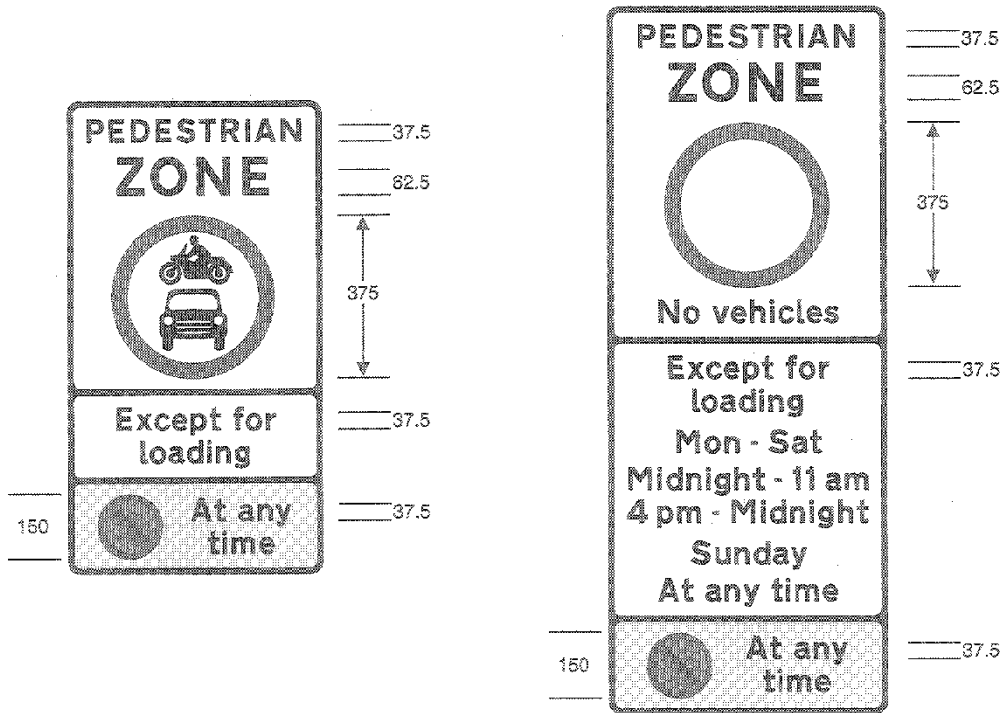

618.3  
Entry to and waiting in pedestrian zone restricted  
(Alternative types)

Item	
1	Regulations: 22
2	Directions: 7, 3, 22(2)
3	Diagrams: 618.4, 637.2
4	<p>Permitted variants: Schedule 16, items 37, 38 "loading" may be varied to:</p> <ol style="list-style-type: none"> <li>1. "loading by" with the goods vehicle symbol shown in diagram 618.2</li> <li>2. "permit holders"</li> <li>3. the orange badge symbol shown in diagram 661</li> <li>4. "buses"</li> <li>5. "local buses"</li> <li>6. "taxis"</li> </ol> <p>These variants may be used in any combination with each other and with "Except for loading" except that 1 shall not be used with "Except for loading", and 4 and 5 shall not be used together. The word "and" shall be inserted before the last variant where more than one is used.</p>
5	<p>Illumination requirements: Schedule 17, item 1</p>

Status: This is the original version (as it was originally made). This item of legislation is currently only available in its original format.

SCHEDULE 2 REGULATORY SIGNS (contd.)

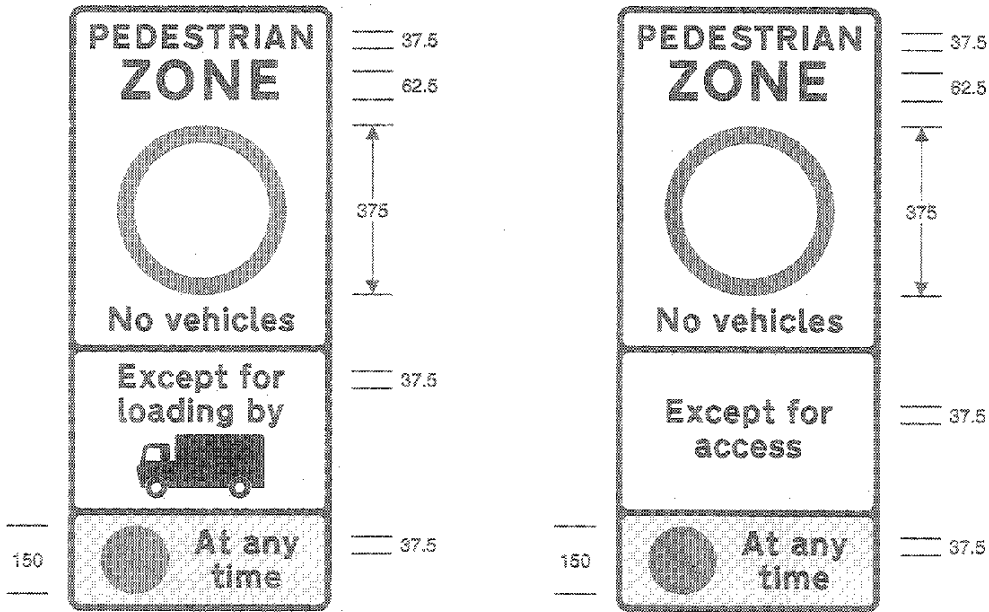

618.3A

Entry to and waiting in pedestrian zone restricted  
(Variable message sign)

Item	
1	Regulations: 22
2	Directions: 7, 8, 22(2), 49
3	Diagrams: 618.4, 637.2
4	<p>Permitted variants:</p> <p>The diagram 617 symbol may be varied to a diagram 619 symbol in which case the words "No vehicles" shall be omitted.</p> <p>"loading by" and the goods vehicle symbol may be varied to:</p> <ol style="list-style-type: none"> <li>1. "loading"</li> <li>2. "permit holders"</li> <li>3. the orange badge symbol shown in diagram 681</li> <li>4. "buses"</li> <li>5. "local buses"</li> <li>6. "taxis"</li> </ol> <p>These variants may be used in any combination with each other and with "Except for loading by" and the goods vehicle symbol, except that 1 shall not be used with "Except for loading by" and the goods vehicle symbol, and 4 and 5 shall not be used together. The word "and" shall be inserted before the last variant where more than one is used.</p>
5	Illumination requirements: Schedule 17, item 1

**Status:** This is the original version (as it was originally made). This item of legislation is currently only available in its original format.

SCHEDULE 2 REGULATORY SIGNS (contd.)

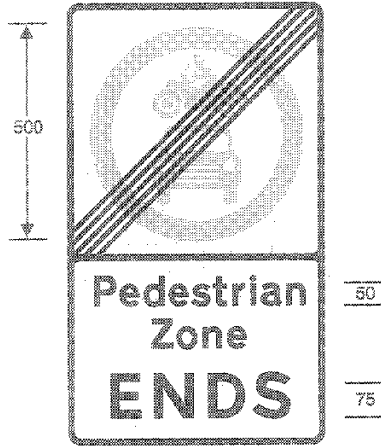

618.4  
End of restrictions associated with a pedestrian zone

Item	
1	Regulations: None
2	Directions: 7, 9
3	Diagrams: 618.2, 618.3, 618.3A
4	Permitted variants: The diagram 619 symbol may be varied to a grey symbol of diagram 617.
5	Illumination requirements: Schedule 17, item 1

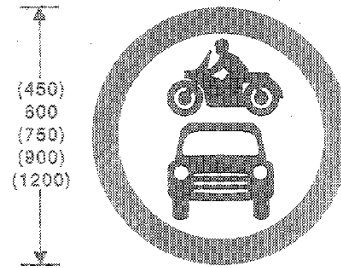

619  
Motor vehicles prohibited

Item	
1	Regulations: None
2	Directions: 7, 8, 19
3	Diagrams: 620, 620.1
4	Permitted variants: None
5	Illumination requirements: Schedule 17, item 1

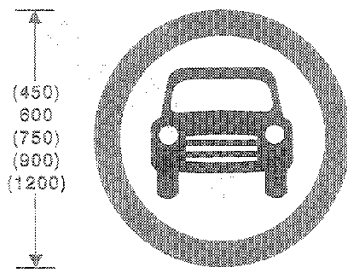

619.1  
Motor vehicles except motorcycles without sidecars prohibited

Item	
1	Regulations: None
2	Directions: 7, 8, 19
3	Diagrams: 620, 620.1
4	Permitted variants: None
5	Illumination requirements: Schedule 17, item 1

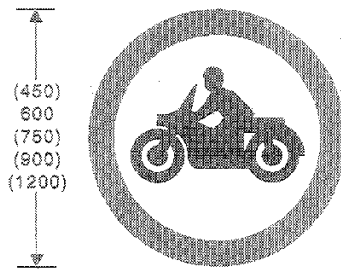

619.2  
Motorcycles prohibited

Item	
1	Regulations: None
2	Directions: 7, 8, 19
3	Diagrams: 620
4	Permitted variants: None
5	Illumination requirements: Schedule 17, item 1

*Status: This is the original version (as it was originally made). This item of legislation is currently only available in its original format.*

SCHEDULE 2 REGULATORY SIGNS (contd.)

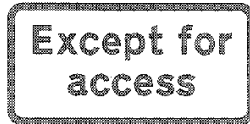

(37.5)  
50  
(62.5)  
(75)  
(100)  
(125)

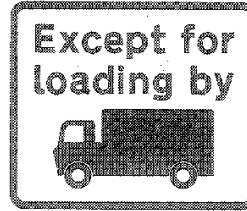

(37.5)  
50  
(62.5)  
(75)  
(100)  
(125)

620

Vehicles requiring access to premises or land adjacent to the road are exempted from the prohibition conveyed by the associated sign

Item	
1	Regulations: 22
2	Directions: 7, 8, 19
3	Diagrams: 619, 619.1, 619.2, 622.1A, 622.5, 622.6, 629, 629.1, 952
4	Permitted variants: Schedule 16, Item 38 Same as diagram 618.1
5	Illumination requirements: Schedule 17, Item 8

620.1

Goods vehicles requiring to enter the road for loading or unloading of goods exempted from the prohibition conveyed by the associated sign

Item	
1	Regulations: None
2	Directions: 7, 8, 19
3	Diagrams: 619, 619.1
4	Permitted variants: Schedule 16, item 38
5	Illumination requirements: Schedule 17, Item 8

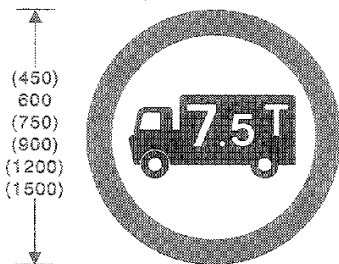

622.1A

Goods vehicles exceeding the maximum gross weight indicated on the goods vehicle symbol prohibited

Item	
1	Regulations: None
2	Directions: 7, 8, 19
3	Diagrams: 654.3, 620
4	Permitted variants: "7.5T" may be varied to "17T"
5	Illumination requirements: Schedule 17, item 1

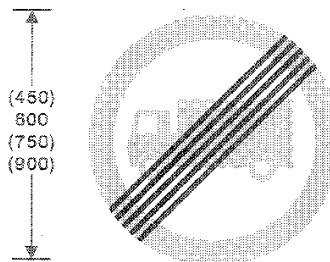

622.2

End of prohibition of goods vehicles exceeding the maximum gross weight indicated by signs to diagram 622.1A

Item	
1	Regulations: None
2	Directions: 7, 9
3	Diagrams: None
4	Permitted variants: None
5	Illumination requirements: Schedule 17, item 1

**Status:** This is the original version (as it was originally made). This item of legislation is currently only available in its original format.

SCHEDULE 2 REGULATORY SIGNS (contd.)

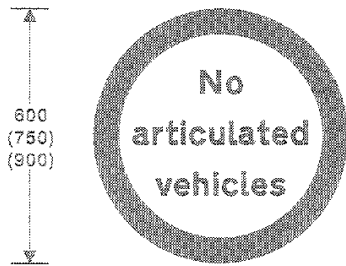

622.4  
Articulated vehicles prohibited

Item	
1	Regulations: None
2	Directions: 7, 8, 19
3	Diagrams: 554.3
4	Permitted variants: "No articulated vehicles" may be varied to "No track laying vehicles"
5	Illumination requirements: Schedule 17, item 1

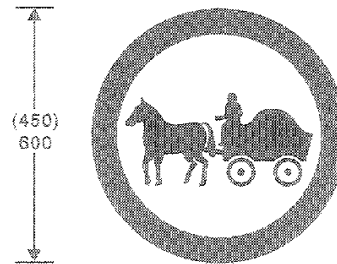

622.5  
Horse drawn vehicles prohibited

Item	
1	Regulations: None
2	Directions: 7, 8, 19
3	Diagrams: 620
4	Permitted variants: None
5	Illumination requirements: Schedule 17, item 8

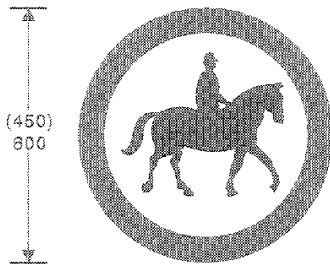

622.6  
Ridden or accompanied horses prohibited

Item	
1	Regulations: None
2	Directions: 7, 8, 19
3	Diagrams: 620
4	Permitted variants: None
5	Illumination requirements: Schedule 17, item 8

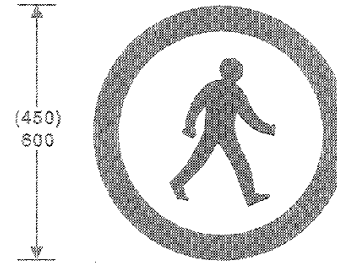

625.1  
Pedestrians prohibited

Item	
1	Regulations: None
2	Directions: 7, 8
3	Diagrams: None
4	Permitted variants: None
5	Illumination requirements: Schedule 17, item 9

Status: This is the original version (as it was originally made). This item of legislation is currently only available in its original format.

SCHEDULE 2 REGULATORY SIGNS (contd.)

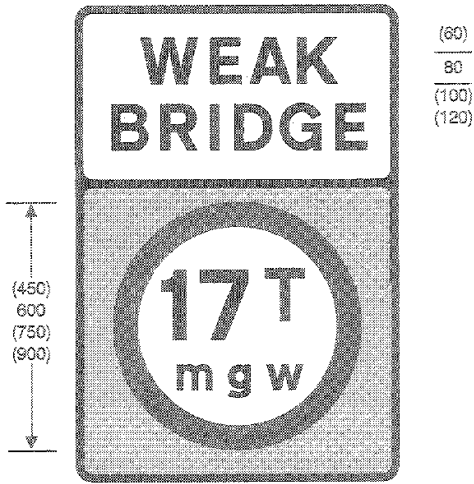

(60)  
80  
(100)  
(120)

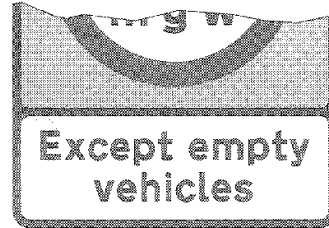

(37.5)  
50  
(62.5)  
(75)

626.2

Vehicles exceeding the maximum gross weight indicated prohibited from crossing the bridge or other structure

Item	
1	Regulations: 10(1)
2	Directions: 7, 8, 19
3	Diagrams: 627.1
4	Permitted variants: "17T" may be varied to "3T", "7.5T", "10T", "13T", "25T" or "33T"
5	Illumination requirements: Schedule 17, item 1

627.1

Exemption for unladen vehicles from the prohibition conveyed by the sign in diagram 626.2

Item	
1	Regulations: None
2	Directions: 7, 8, 19
3	Diagrams: 626.2
4	Permitted variants: None
5	Illumination requirements: Schedule 17, item 8

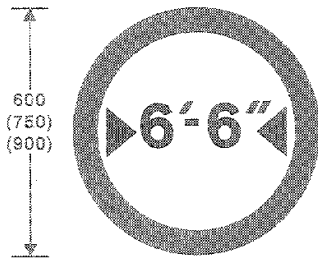

629

Vehicles exceeding width indicated prohibited

Item	
1	Regulations: None
2	Directions: 7, 8, 19, 35
3	Diagrams: 554.3, 620, 954, 954.1, 954.2
4	Permitted variants: Schedule 16, items 1, 2
5	Illumination requirements: Schedule 17, item 1

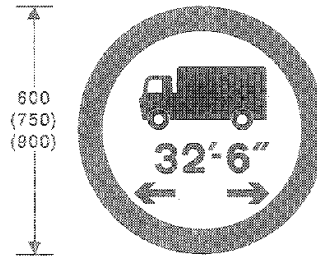

629.1

Vehicles or combinations of vehicles exceeding length indicated prohibited

Item	
1	Regulations: None
2	Directions: 7, 8, 19, 35
3	Diagrams: 554.3, 620, 954, 954.1, 954.2
4	Permitted variants: Schedule 16, items 1, 2
5	Illumination requirements: Schedule 17, item 1



**Status:** This is the original version (as it was originally made). This item of legislation is currently only available in its original format.

SCHEDULE 2 REGULATORY SIGNS (contd.)

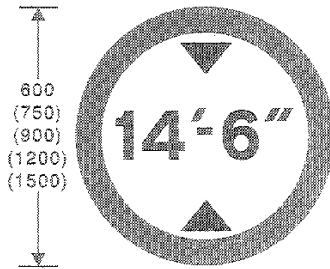

629.2  
Vehicles exceeding height indicated prohibited

Item	
1	Regulations: 10(1), 10(2)
2	Directions: 7, 8, 19
3	Diagrams: 530.2
4	Permitted variants: Schedule 16, item 1
5	Illumination requirements: Schedule 17, item 1

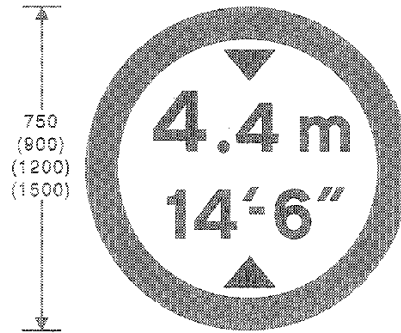

629.2A  
As diagram 629.2, with height indicated in both metric and imperial units

Item	
1	Regulations: 10(1), 10(2)
2	Directions: 7, 8, 19
3	Diagrams: 530.2
4	Permitted variants: Schedule 16, item 1
5	Illumination requirements: Schedule 17, item 1

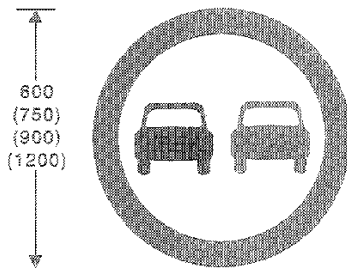

632  
No overtaking

Item	
1	Regulations: None
2	Directions: 7, 8, 10, 19
3	Diagrams: 554.3, 570, 645
4	Permitted variants: None
5	Illumination requirements: Schedule 17, item 1



633  
Vehicular traffic must not proceed beyond the sign where displayed temporarily by a police officer in uniform or a traffic warden

Item	
1	Regulations: 42
2	Directions: None
3	Diagrams: None
4	Permitted variants: None
5	Illumination requirements: Schedule 17, item 4

Status: This is the original version (as it was originally made). This item of legislation is currently only available in its original format.

SCHEDULE 2 REGULATORY SIGNS (contd.)

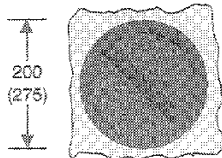

636  
Temporary prohibition of waiting except for loading and unloading

Item	
1	Regulations: 12(7)
2	Directions: 7, 10, 19
3	Diagrams: 636.1, 643, 644
4	Permitted variants: Name of the police force or the word "Police" may be added above or below the roundel
5	Illumination requirements: Schedule 17, item 9



636.1  
Temporary prohibition of loading and unloading

Item	
1	Regulations: None
2	Directions: 7, 10
3	Diagrams: 636
4	Permitted variants: None
5	Illumination requirements: Schedule 17, item 9

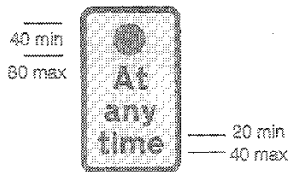

637  
Continuous prohibition on waiting except for loading and unloading (Alternative types)

Item	
1	Regulations: None
2	Directions: 7, 10, 22, 23
3	Diagrams: 1018.1
4	Permitted variants: Schedule 16, item 11
5	Illumination requirements: Schedule 17, item 9

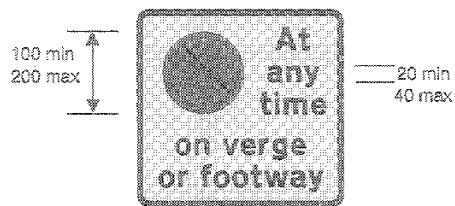

637.1  
Continuous prohibition on waiting except loading or unloading on verge or footway

Item	
1	Regulations: None
2	Directions: 7, 10
3	Diagrams: None
4	Permitted variants: Schedule 16, item 11 The sign shown in diagram 642 may be substituted for the symbol of the sign shown in diagram 636. The words "verge or" or "or footway" may be omitted.
5	Illumination requirements: Schedule 17, item 9

**Status:** This is the original version (as it was originally made). This item of legislation is currently only available in its original format.

SCHEDULE 2 REGULATORY SIGNS (contd.)

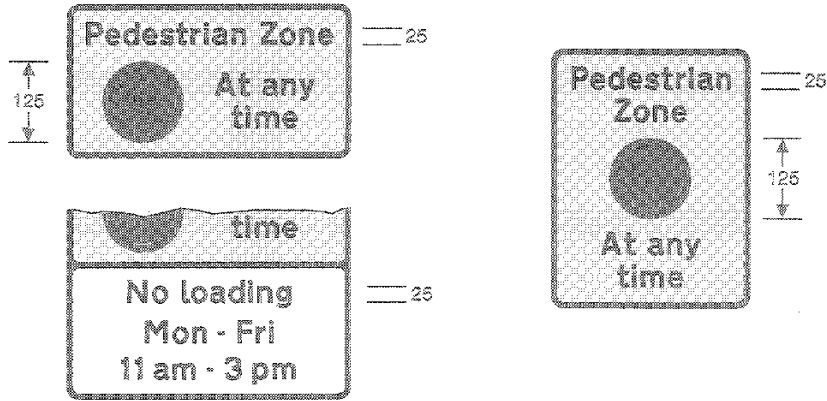

637.2  
Prohibition on waiting (and loading and unloading)  
in a pedestrian zone  
(Alternative types)

Item	
1	Regulations: None
2	Directions: 7, 10, 22, 23
3	Diagrams: 618.2, 618.3, 618.3A, 1017, 1018.1, 1019, 1020.1
4	Permitted variants: Schedule 16, item 37
5	Illumination requirements: Schedule 17, item 9

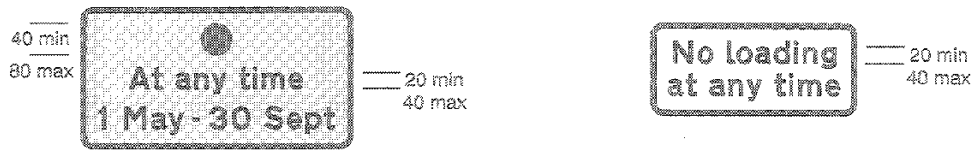

637.3  
Continuous prohibition on waiting except for loading  
and unloading for at least 4 consecutive months

Item	
1	Regulations: None
2	Directions: 7, 10, 22, 23
3	Diagrams: 1018.1
4	Permitted variants: Schedule 16, items 11, 37
5	Illumination requirements: Schedule 17, item 9

638  
Continuous prohibition on  
loading and unloading

Item	
1	Regulations: 12(7)
2	Directions: 7, 10, 22, 23
3	Diagrams: 1020.1
4	Permitted variants: Schedule 16, item 11 "at bus stop" may be inserted after "No loading"
5	Illumination requirements: Schedule 17, item 9

Status: This is the original version (as it was originally made). This item of legislation is currently only available in its original format.

SCHEDULE 2 REGULATORY SIGNS (contd.)

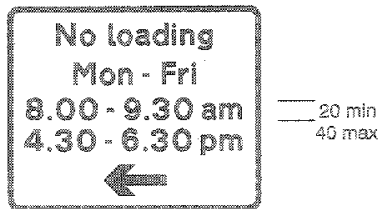

638.1 Loading and unloading prohibited during the periods and in the direction indicated

Item	
1	Regulations: None
2	Directions: 7, 10, 22, 23
3	Diagrams: 1019
4	Permitted variants: Schedule 16, items 13, 14, 37
5	Illumination requirements: Schedule 17, item 9

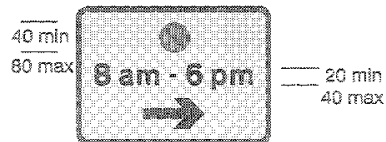

639 Waiting prohibited except for loading and unloading during the period and in the direction indicated

Item	
1	Regulations: None
2	Directions: 7, 10, 22, 23
3	Diagrams: 1017
4	Permitted variants: Schedule 16, items 13, 14, 37
5	Illumination requirements: Schedule 17, item 9

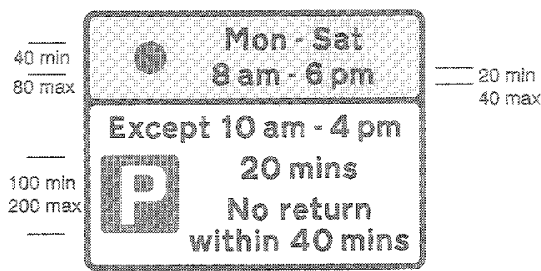

639.1A Waiting prohibited during the period indicated on the upper portion except in accordance with the conditions shown on the lower portion

Item	
1	Regulations: None
2	Directions: 7, 22, 23
3	Diagrams: 1017, 1028.4, 1033
4	Permitted variants: Schedule 16, items 11, 37
5	Illumination requirements: Schedule 17, item 9

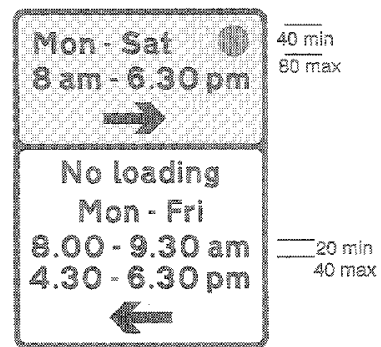

640 Waiting prohibited during the period and in the direction indicated on the upper portion and loading and unloading prohibited during the period and in the direction indicated on the lower portion

Item	
1	Regulations: None
2	Directions: 7, 10, 22, 23
3	Diagrams: 1017, 1019
4	Permitted variants: Schedule 16, items 13, 14, 37
5	Illumination requirements: Schedule 17, item 9

**Status:** This is the original version (as it was originally made). This item of legislation is currently only available in its original format.

SCHEDULE 2 REGULATORY SIGNS (contd.)

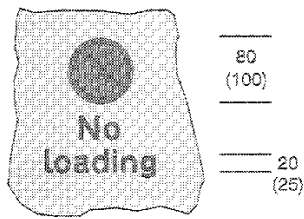

640.1

Waiting, loading and unloading prohibited at a parking place where parking is temporarily suspended (indication on parking meter cover)

Item	
1	Regulations: None
2	Directions: None
3	Diagrams: None
4	Permitted variants: "during meter control" may be added. "No loading" may be omitted.
5	Illumination requirements: Schedule 17, item 9

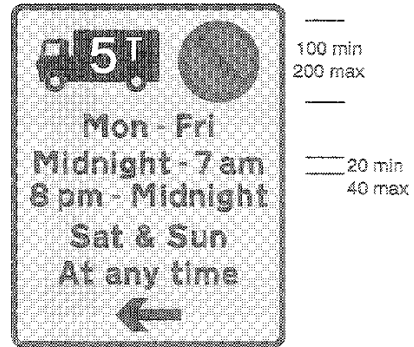

640.2A

Waiting by goods vehicles over maximum gross weight shown prohibited during the periods and in the direction indicated

Item	
1	Regulations: 24(1)
2	Directions: 7
3	Diagrams: None
4	Permitted variants: Schedule 15, items 13, 14, 37 "5T" may be varied to "7.5T". The bus symbol shown in diagram 952 may be added below or substituted for the lorry symbol.
5	Illumination requirements: Schedule 17, item 9

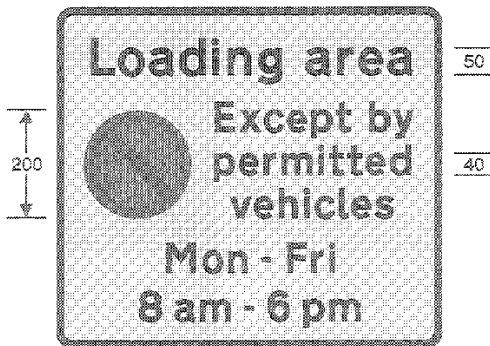

640.3

Entrance to a designated off-highway loading area in which waiting restrictions apply

Item	
1	Regulations: None
2	Directions: 7
3	Diagrams: None
4	Permitted variants: Schedule 15, item 37
5	Illumination requirements: Schedule 17, item 9

Status: This is the original version (as it was originally made). This item of legislation is currently only available in its original format.

SCHEDULE 2 REGULATORY SIGNS (contd.)

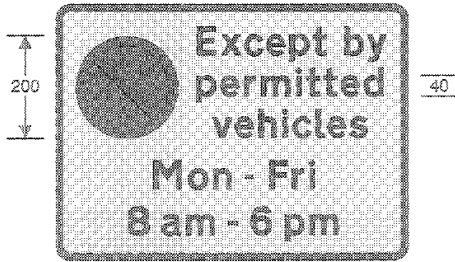

640.4  
Waiting prohibited in a designated off-highway loading area during the period indicated except by permitted vehicles

Item	
1	Regulations: None
2	Directions: 7
3	Diagrams: None
4	Permitted variants: Schedule 16, item 37
5	Illumination requirements: Schedule 17, item 9

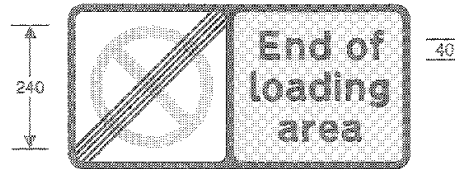

640.5  
End of designated off-highway loading area in which waiting restrictions apply

Item	
1	Regulations: None
2	Directions: 7
3	Diagrams: None
4	Permitted variants: None
5	Illumination requirements: Schedule 17, item 9

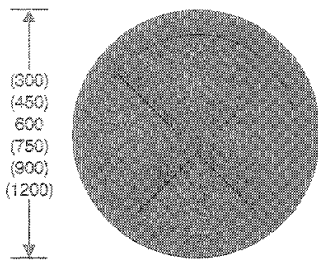

642  
No stopping on main carrieway

Item	
1	Regulations: 12(7)
2	Directions: 7, 8, 10, 19
3	Diagrams: 570, 343, 644, 645
4	Permitted variants: None
5	Illumination requirements: Schedule 17, items 1, 4

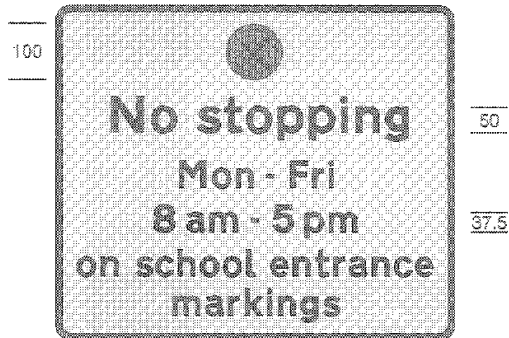

642.2  
No stopping at school entrance during periods indicated

Item	
1	Regulations: None
2	Directions: 7, 20, 22
3	Diagrams: 1027.1
4	Permitted variants: Schedule 16, item 37
5	Illumination requirements: Schedule 17, item 9

**Status:** This is the original version (as it was originally made). This item of legislation is currently only available in its original format.

SCHEDULE 2 REGULATORY SIGNS (contd.)

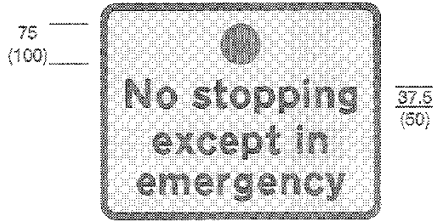

642.3  
No stopping in lay-by except in emergency

Item	
1	Regulations: None
2	Directions: 7, 22, 23
3	Diagrams: 1018.1, 1020.1, 2714, 2715
4	Permitted variants: None
5	Illumination requirements: Schedule 17, item 3

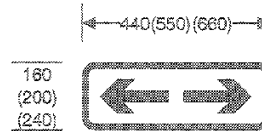

643  
Restriction or prohibition conveyed by associated sign applies in both directions

Item	
1	Regulations: 12(7)
2	Directions: 7, 19
3	Diagrams: 636, 642
4	Permitted variants: None
5	Illumination requirements: Schedule 17, item 8

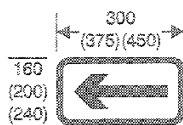

644  
Restriction or prohibition conveyed by associated sign applies in direction indicated

Item	
1	Regulations: 12(7)
2	Directions: 7, 19
3	Diagrams: 636, 642
4	Permitted variants: Schedule 16, item 13
5	Illumination requirements: Schedule 17, item 8

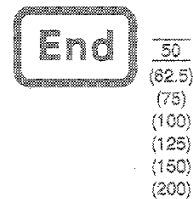

645  
End of restriction or prohibition conveyed by associated sign or, when used with the sign shown in diagram 7001, end of all restrictions or prohibitions associated with road works

Item	
1	Regulations: 12(7)
2	Directions: 9, 19
3	Diagrams: 614, 615, 632, 642, 611, 7001
4	Permitted variants: None
5	Illumination requirements: Schedule 17, item 8

*Status: This is the original version (as it was originally made). This item of legislation is currently only available in its original format.*

SCHEDULE 2 REGULATORY SIGNS (contd.)

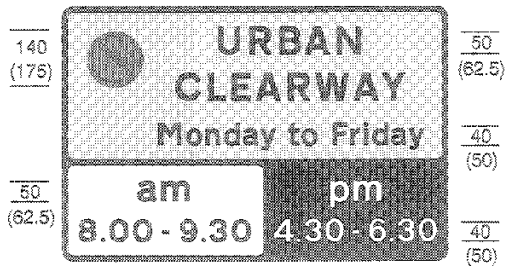

646  
No stopping during periods indicated except for so long as may be necessary for the purpose of picking up or setting down passengers

Item	
1	Regulations: None
2	Directions: 7, 8, 10
3	Diagrams: None
4	Permitted variants: Schedule 16, item 37
5	Illumination requirements: Schedule 17, item 4

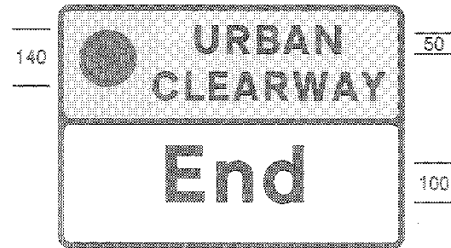

647  
End of restriction on stopping

Item	
1	Regulations: None
2	Directions: 7, 9
3	Diagrams: None
4	Permitted variants: None
5	Illumination requirements: Schedule 17, item 4



650.1  
Prohibition on stopping by vehicles other than taxis during period indicated

Item	
1	Regulations: None
2	Directions: 7, 22, 23
3	Diagrams: 857.1, 1028.2
4	Permitted variants: Schedule 16, items 11, 37
5	Illumination requirements: Schedule 17, item 9

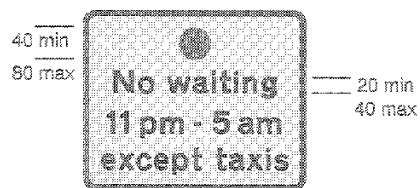

650.2  
Prohibition on waiting by vehicles other than taxis during period indicated

Item	
1	Regulations: None
2	Directions: 7, 22, 23
3	Diagrams: 857.1, 1028.2
4	Permitted variants: Schedule 16, items 11, 37
5	Illumination requirements: Schedule 17, item 9



**Status:** This is the original version (as it was originally made). This item of legislation is currently only available in its original format.

SCHEDULE 2 REGULATORY SIGNS (contd.)

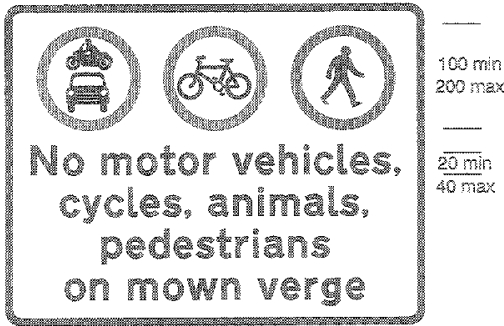

100 min  
200 max

20 min  
40 max

651

Use of verge maintained in mown or ornamental condition by specified traffic prohibited

Item	
1	Regulations: None
2	Directions: 7, 36, 37
3	Diagrams: None
4	Permitted variants: Schedule 16, item 11 The word "animals" or the diagram 625.1 symbol and the word "pedestrians" may be omitted, or this symbol and both these words may be omitted
5	Illumination requirements: Schedule 17, item 9

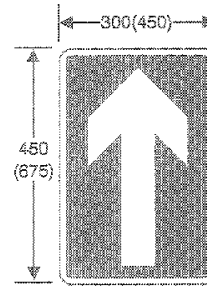

652

One way traffic

Item	
1	Regulations: None
2	Directions: 7
3	Diagrams: None
4	Permitted variants: None
5	Illumination requirements: Schedule 17, item 1



660

Parking place reserved for permit holders

Item	
1	Regulations: None
2	Directions: 7, 22, 23
3	Diagrams: 1028.3, 1028.4, 1033
4	Permitted variants: Schedule 16, items 11, 38 "Permit holders only" may be varied to: 1. "Card holders only" 2. "Doctor permit holders only" 3. "Large or slow vehicles only" 4. "Business permit holders only" 5. "Resident permit holders only"
5	Illumination requirements: Schedule 17, item 9

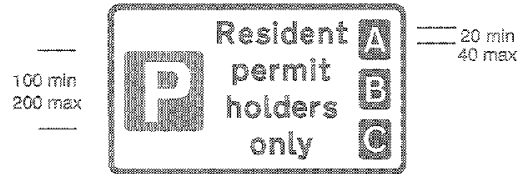

660.3

Parking place reserved for holders of residents' permits

Item	
1	Regulations: None
2	Directions: 7, 22, 23
3	Diagrams: 1028.4, 1033
4	Permitted variants: Schedule 16, items 11, 38 The code letters may be varied as appropriate. "Resident permit holders only" may be varied to: 1. "Permit holders only" 2. "Doctor permit holders only" 3. "Business permit holders only"
5	Illumination requirements: Schedule 17, item 9

**Status:** This is the original version (as it was originally made). This item of legislation is currently only available in its original format.

SCHEDULE 2 REGULATORY SIGNS (contd.)



660.4  
Part of the carriageway reserved  
for loading and unloading

Item	
1	Regulations: None
2	Directions: 7, 22, 23
3	Diagrams: 1028.3, 1033
4	Permitted variants: The words "Goods vehicles" may be added before "Loading only". Schedule 16, items 11, 38
5	Illumination requirements: Schedule 17, item 9

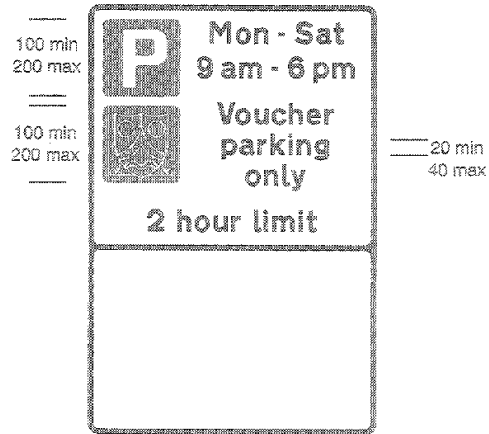

660.5  
Parking place reserved for voucher parking  
during the period indicated

Item	
1	Regulations: None
2	Directions: 7, 22, 23
3	Diagrams: 1028.4, 1032, 1033
4	Permitted variants: Schedule 16, items 11, 37 The words "and resident permits", "and business permits" or "and permits" may be inserted after "Voucher parking". Permit identification code letters as shown in diagram 660.3 may be added. The voucher parking symbol is to be varied to correspond with the design on the approved voucher within the size shown. Information on the voucher parking scheme may be shown in the lower panel. The lower panel may be omitted.
5	Illumination requirements: Schedule 17, item 9

**Status:** This is the original version (as it was originally made). This item of legislation is currently only available in its original format.

SCHEDULE 2 REGULATORY SIGNS (contd.)



661  
Parking place reserved for disabled badge holders

Item	
1	Regulations: None
2	Directions: 7, 22, 23
3	Diagrams: 1028.3, 1033
4	Permitted variants: Schedule 16, Items 11, 38
5	Illumination requirements: Schedule 17, Item 9

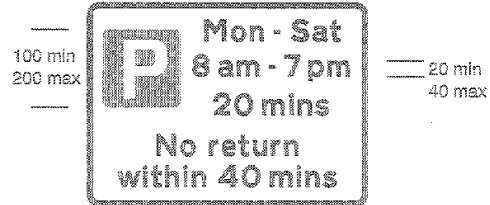

661.1  
Restrictions on length of waiting time and return period

Item	
1	Regulations: None
2	Directions: 7, 22, 23
3	Diagrams: 1028.4, 1033
4	Permitted variants: Schedule 16, Items 11, 37 The legend may be varied to accord with the conditions imposed on the parking place, or varied to the word "Free"
5	Illumination requirements: Schedule 17, Item 9

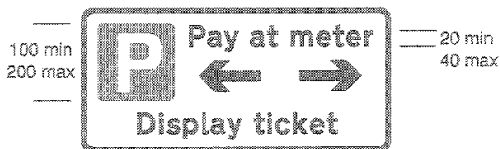

661.2  
'Pay and Display' ticket-regulated parking place

Item	
1	Regulations: None
2	Directions: 7, 22, 23
3	Diagrams: 1028.4, 1032, 1033, 661.4
4	Permitted variants: Schedule 16, item 38 Either one of the arrows may be omitted
5	Illumination requirements: Schedule 17, item 9



661.3  
Location of 'Pay and Display' ticket machine

Item	
1	Regulations: None
2	Directions: 7
3	Diagrams: 1028.4, 1032, 1033, 661.4
4	Permitted variants: Schedule 16, item 38
5	Illumination requirements: Schedule 17, item 9

Status: This is the original version (as it was originally made). This item of legislation is currently only available in its original format.

SCHEDULE 2 REGULATORY SIGNS (contd.)

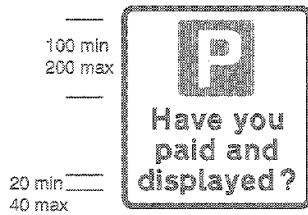

661.4

Drivers must obtain and display parking tickets (Alternative types)

Item	
1	Regulations: None
2	Directions: 7
3	Diagrams: 661.2, 661.3
4	Permitted variants: None
5	Illumination requirements: Schedule 17, item 9

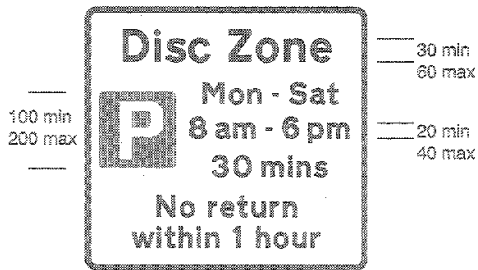

662

Period during which waiting is limited and display of a disc is required at a parking place in a disc zone

Item	
1	Regulations: None
2	Directions: 7, 22, 28
3	Diagrams: 1028.4, 1032, 1033
4	Permitted variants: "Disc" may be varied to "Ticket" Schedule 16, items 11, 37
5	Illumination requirements: Schedule 17, item 9

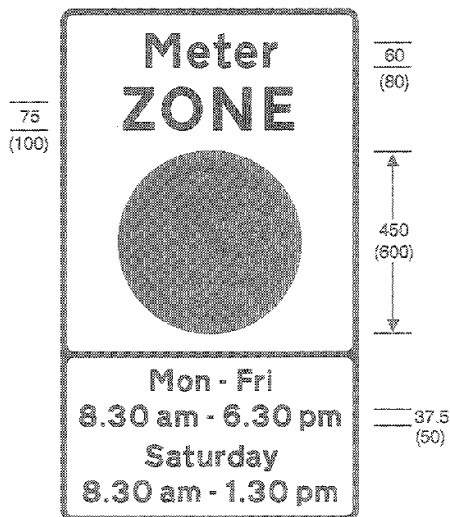

663

Entrance to controlled parking zone

Item	
1	Regulations: None
2	Directions: 7, 8, 23, 24
3	Diagrams: 1017, 1018.1, 1019, 1020.1, 1028.3, 1028.4, 1032, 1033
4	Permitted variants: Schedule 16, item 37 "Meter" may be varied to: 1. "Controlled" 2. "Disc" 3. "Ticket" 4. "Disc and meter" 5. "Ticket and meter" 6. "Pay and display" The lower portion of the sign may be omitted where the restrictions apply at all times. The legend "No loading" may be added beneath the no waiting roundel.
5	Illumination requirements: Schedule 17, item 4

**Status:** This is the original version (as it was originally made). This item of legislation is currently only available in its original format.

SCHEDULE 2 REGULATORY SIGNS (contd.)

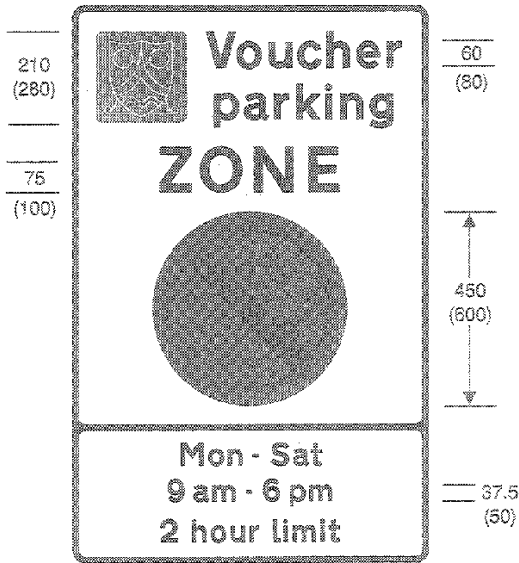

663.1  
Entrance to a voucher parking zone

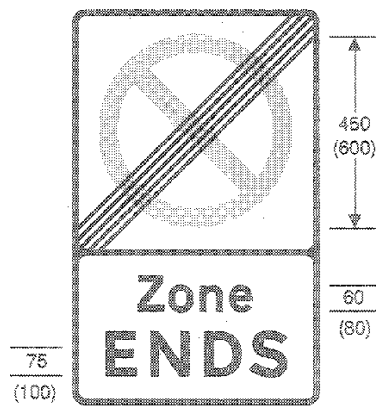

664  
End of controlled or voucher parking zone

Item	
1	Regulations: None
2	Directions: 7, 8, 23, 24
3	Diagrams: 1017, 1018.1, 1019, 1020.1, 1028.3, 1028.4, 1033
4	Permitted variants: Schedule 16, item 37 The reference to a time limit may be omitted. The voucher parking symbol is to be varied to correspond with the design on the approved voucher within the size shown. The legend "No loading" may be added below the no waiting roundel.
5	Illumination requirements: Schedule 17, item 4

Item	
1	Regulations: None
2	Directions: 7, 9, 24
3	Diagrams: 1017, 1018.1, 1019, 1020.1, 1028.3, 1028.4, 1032, 1033
4	Permitted variants: None
5	Illumination requirements: Schedule 17, item 4

*Status: This is the original version (as it was originally made). This item of legislation is currently only available in its original format.*

SCHEDULE 2 REGULATORY SIGNS (contd.)

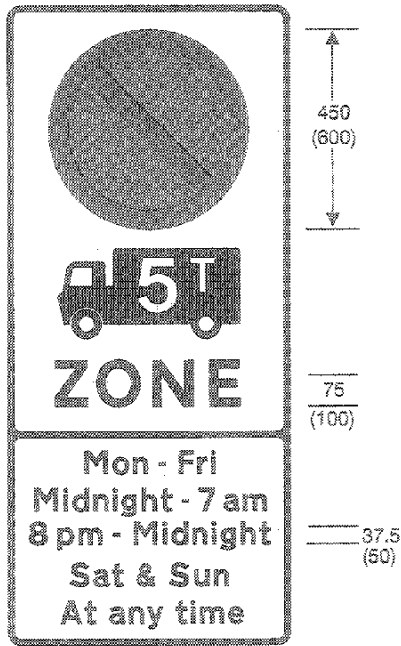

665

Entrance to a controlled parking zone applying to goods vehicles over maximum gross weight shown

Item	
1	Regulations: 24(1)
2	Directions: 7, 8, 23, 24
3	Diagrams: None
4	Permitted variants: Schedule 18, item 37 "5T" may be varied to "7.5T" The bus symbol shown in diagram 952 may be added below or substituted for the lorry symbol
5	Illumination requirements: Schedule 17, item 4

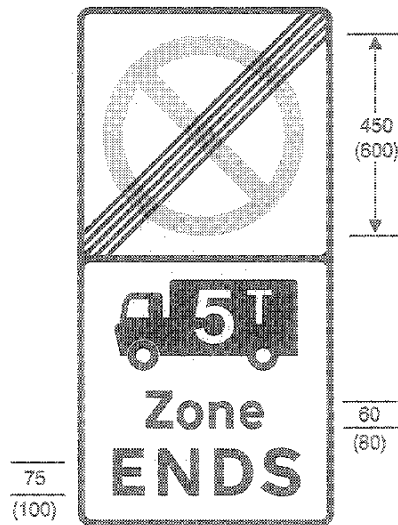

666

End of a controlled parking zone applying to goods vehicles over maximum gross weight shown

Item	
1	Regulations: 24(1)
2	Directions: 7, 9, 23, 24
3	Diagrams: None
4	Permitted variants: "5T" may be varied to "7.5T" The bus symbol shown in diagram 952 may be added below or substituted for the lorry symbol
5	Illumination requirements: Schedule 17, item 4

**Status:** This is the original version (as it was originally made). This item of legislation is currently only available in its original format.

SCHEDULE 2 REGULATORY SIGNS (contd.)

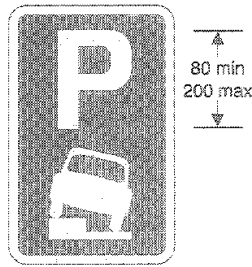

**667**  
Vehicles may be parked partially on the verge or footway

Item	
1	Regulations: None
2	Directions: 7, 8
3	Diagrams: None
4	Permitted variants: None
5	Illumination requirements: Schedule 17, item 9

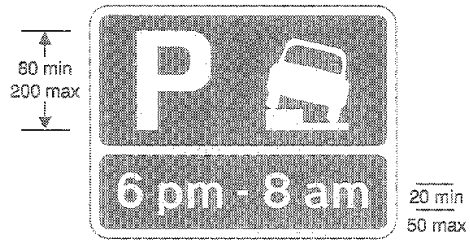

**667.1**  
Vehicles may be parked partially on the verge or footway during the period indicated

Item	
1	Regulations: None
2	Directions: 7, 8
3	Diagrams: None
4	Permitted variants: Schedule 16, item 37
5	Illumination requirements: Schedule 17, item 9

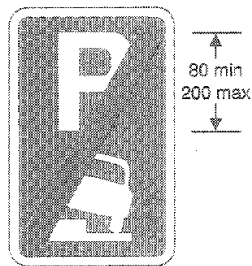

**667.2**  
End of area where vehicles may be parked partially on the verge or footway

Item	
1	Regulations: None
2	Directions: 7, 9
3	Diagrams: None
4	Permitted variants: None
5	Illumination requirements: Schedule 17, item 9

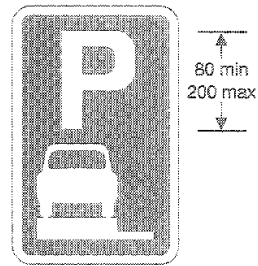

**668**  
Vehicles may be parked wholly on the verge or footway

Item	
1	Regulations: None
2	Directions: 7, 8
3	Diagrams: None
4	Permitted variants: None
5	Illumination requirements: Schedule 17, item 9

Status: This is the original version (as it was originally made). This item of legislation is currently only available in its original format.

SCHEDULE 2 REGULATORY SIGNS (contd.)

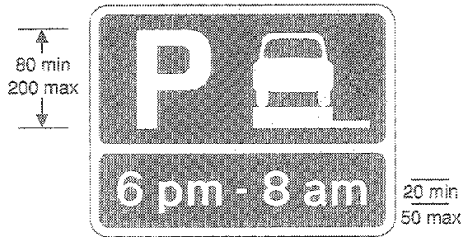

668.1

Vehicles may be parked wholly on the verge or footway during the period indicated

Item	
1	Regulations: None
2	Directions: 7, 8
3	Diagrams: None
4	Permitted variants: Schedule 18, item 37
5	Illumination requirements: Schedule 17, item 9

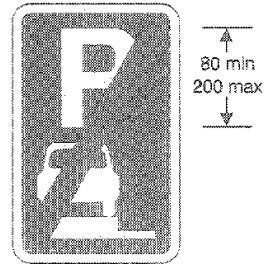

668.2

End of area where vehicles may be parked wholly on the verge or footway

Item	
1	Regulations: None
2	Directions: 7, 8
3	Diagrams: None
4	Permitted variants: None
5	Illumination requirements: Schedule 17, item 9



669

Nature of and distance to a prohibition, restriction or requirement ahead

Item	
1	Regulations: None
2	Directions: 7
3	Diagrams: None
4	Permitted variants: Schedule 16, items 8, 10, 11 The legend shall be varied to accord with the prohibition, restriction or requirement.
5	Illumination requirements: Schedule 17, item 1



**Status:** This is the original version (as it was originally made). This item of legislation is currently only available in its original format.

SCHEDULE 2 REGULATORY SIGNS (contd.)

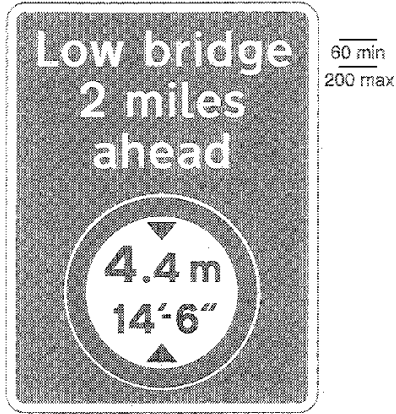

669.1  
Same as diagram 669

Item	
1	Regulations: None
2	Directions: 7
3	Diagrams: None
4	Permitted variants: Schedule 16, items 1, 6, 10, 11 "Low bridge" may be varied to "Weight limit" "Weak bridge", "Width limit", "Length limit" or omitted. The diagram 629.2A symbol may be varied to diagrams 622.1A, 626.2, 629, 629.1 or 629.2 as appropriate to accord with the prohibition
5	Illumination requirements: Schedule 17, item 1

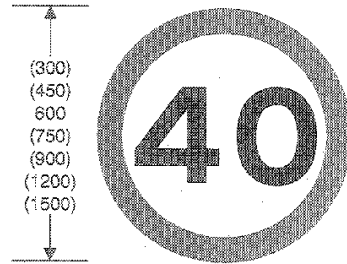

670  
Maximum speed limit

Item	
1	Regulations: 46
2	Directions: 7, 8, 10
3	Diagrams: None
4	Permitted variants: Schedule 16, item 1
5	Illumination requirements: Schedule 17, items 10, 11

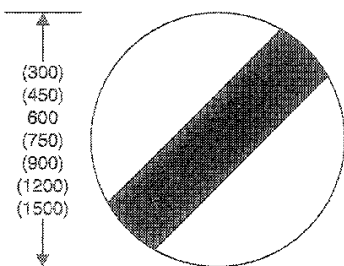

671  
National speed limits apply

Item	
1	Regulations: None
2	Directions: 7, 9, 10
3	Diagrams: None
4	Permitted variants: None
5	Illumination requirements: Schedule 17, items 10, 11

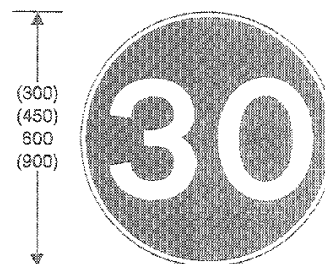

672  
Minimum speed limit

Item	
1	Regulations: None
2	Directions: 7, 8, 10
3	Diagrams: None
4	Permitted variants: Schedule 16, item 1
5	Illumination requirements: Schedule 17, items 10, 11

Status: This is the original version (as it was originally made). This item of legislation is currently only available in its original format.

SCHEDULE 2 REGULATORY SIGNS (contd.)

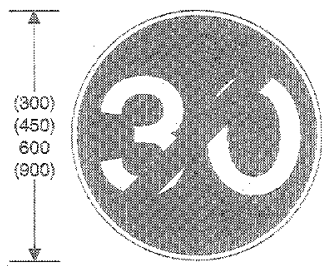

673  
End of a minimum speed limit

Item	
1	Regulations: None
2	Directions: 7, 9
3	Diagrams: None
4	Permitted variants: Schedule 16, item 1
5	Illumination requirements: Schedule 17, items 10, 11

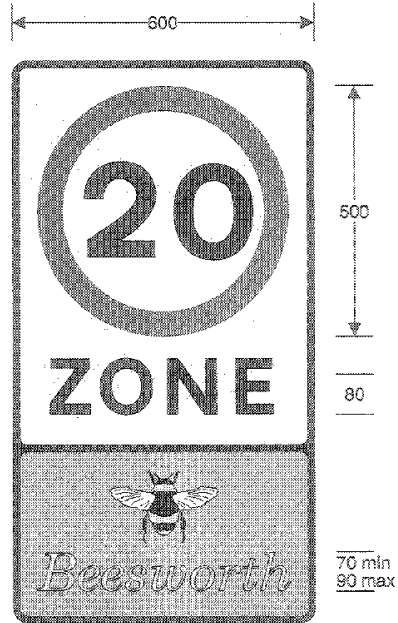

674  
Entrance to a 20mph speed limit zone

Item	
1	Regulations: 13(1)
2	Directions: 7, 8, 16
3	Diagrams: None
4	Permitted variants: Schedule 16, item 19 The place name may be omitted. The bottom panel may be omitted. The symbol or pictogram may be varied or omitted. The place name may be in any style of lettering. Any contrasting colours except red may be used for the place name and the background of that part of the sign. Advertising material or political slogans must not be included on the sign
5	Illumination requirements: Schedule 17, item 11

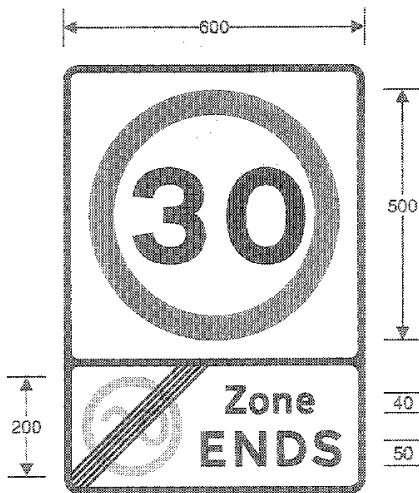

675  
End of a 20mph speed limit zone

Item	
1	Regulations: None
2	Directions: 7, 9
3	Diagrams: None
4	Permitted variants: Schedule 16, item 1
5	Illumination requirements: Schedule 17, item 11

**Status:** This is the original version (as it was originally made). This item of legislation is currently only available in its original format.

SCHEDULE 3

Regulation 11(1)

SIGNS FOR RAILWAY AND TRAMWAY LEVEL CROSSINGS

SCHEDULE 3  
SIGNS FOR RAILWAY AND TRAMWAY LEVEL CROSSINGS

Regulation 11(1)

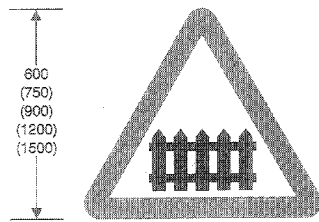

770  
Level crossing with gate or barrier ahead

Item	
1	Regulations: None
2	Directions: 19
3	Diagrams: 572, 573, 773
4	Permitted variants: None
5	Illumination requirements: Schedule 17, item 1

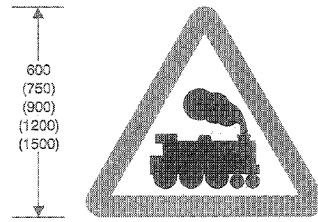

771  
Railway level crossing without gate or barrier ahead

Item	
1	Regulations: None
2	Directions: 19
3	Diagrams: 572, 573, 773
4	Permitted variants: None
6	Illumination requirements: Schedule 17, item 1

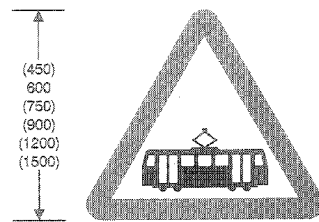

772  
Tramcars crossing ahead

Item	
1	Regulations: None
2	Directions: 19
3	Diagrams: 572, 573, 773
4	Permitted variants: None
5	Illumination requirements: Schedule 17, item 1

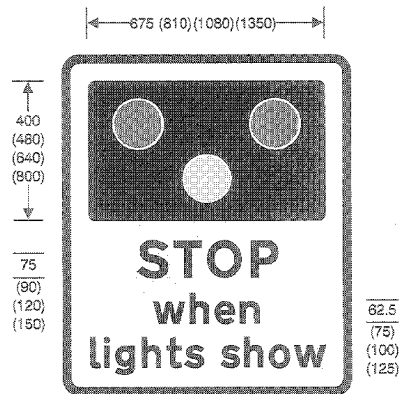

773  
Light signals as shown in diagram 3014 ahead

Item	
1	Regulations: None
2	Directions: 19
3	Diagrams: 529, 529.1, 558, 770, 771, 772
4	Permitted variants: None
5	Illumination requirements: Schedule 17, item 8

*Status: This is the original version (as it was originally made). This item of legislation is currently only available in its original format.*

SCHEDULE 3 SIGNS FOR RAILWAY AND TRAMWAY LEVEL CROSSINGS (contd.)

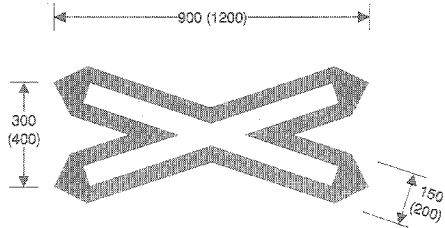

774  
Location of railway or tramway level crossing without gate or barrier

Item	
1	Regulations: None
2	Directions: None
3	Diagrams: 602 with 778 or 778.1, 3014
4	Permitted variants: None
5	Illumination requirements: Schedule 17, item 4

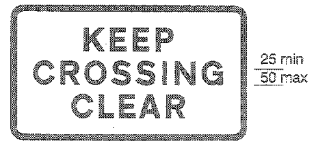

775  
Vehicular traffic must not stop within the area of a railway or tramway level crossing

Item	
1	Regulations: None
2	Directions: None
3	Diagrams: 3014
4	Permitted variants: None
5	Illumination requirements: Schedule 17, item 4

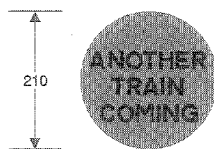

776  
Another train or tramcar may be about to pass over the crossing

Item	
1	Regulations: 18(2), 19(1)
2	Directions: 48(6), 49
3	Diagrams: 3014
4	Permitted variants: "TRAIN" may be varied to "TRAM"
5	Illumination requirements: Schedule 17, item 14

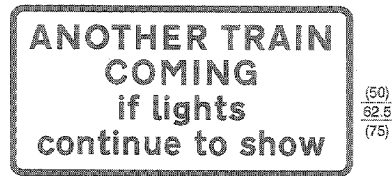

777  
Level crossing ahead is crossed by more than one railway or tramway track, and more than one train or tramcar may pass over it in quick succession

Item	
1	Regulations: None
2	Directions: None
3	Diagrams: 3014
4	Permitted variants: "TRAIN" may be varied to "TRAM"
5	Illumination requirements: Schedule 17, item 4

**Status:** This is the original version (as it was originally made). This item of legislation is currently only available in its original format.

SCHEDULE 3 SIGNS FOR RAILWAY AND TRAMWAY LEVEL CROSSINGS (contd.)

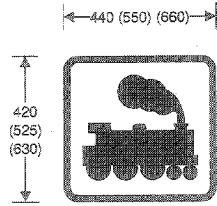

778  
Open railway level crossing without light signals

Item	
1	Regulations: 10(1), 16, 25(3)
2	Directions: 19
3	Diagrams: 602, 1003, 1023
4	Permitted variants: None
5	Illumination requirements: Schedule 17, item 8

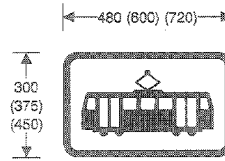

778.1  
Open tramway level crossing without light signals

Item	
1	Regulations: 10(1), 16, 25(3)
2	Directions: 19
3	Diagrams: 602, 1003, 1023
4	Permitted variants: None
5	Illumination requirements: Schedule 17, item 8

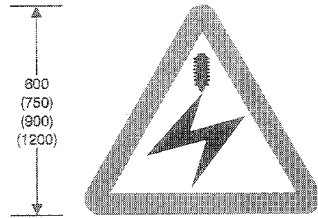

779  
Electrified overhead cable ahead

Item	
1	Regulations: None
2	Directions: 18, 19
3	Diagrams: 760, 760.1, 760.2
4	Permitted variants: None
5	Illumination requirements: Schedule 17, item 1

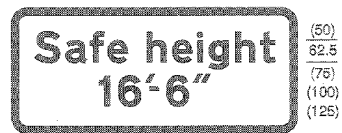

780  
Safe height beneath electrified overhead cable ahead

Item	
1	Regulations: 17(4)
2	Directions: 18, 19, 35
3	Diagrams: 779
4	Permitted variants: Schedule 16, items 1, 2 Legend may appear on three lines
5	Illumination requirements: Schedule 17, item 9

**Status:** This is the original version (as it was originally made). This item of legislation is currently only available in its original format.

SCHEDULE 3 SIGNS FOR RAILWAY AND TRAMWAY LEVEL CROSSINGS (contd.)

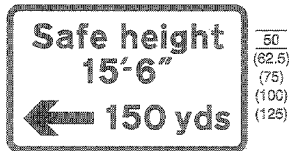

780.1  
Safe height beneath electrified overhead cable  
in direction and at distance indicated

Item	
1	Regulations: 17(4)
2	Directions: 18, 19, 35
3	Diagrams: 779
4	Permitted variants: Schedule 16, items 1, 2, 6, 12, 14
5	Illumination requirements: Schedule 17, item 8

780.2  
Safe height beneath electrified overhead cable ahead  
provided with a load gauge shown in diagram 781

Item	
1	Regulations: 17(4)
2	Directions: 18, 19, 35
3	Diagrams: 779
4	Permitted variants: Schedule 16, items 1, 2
5	Illumination requirements: Schedule 17, item 8

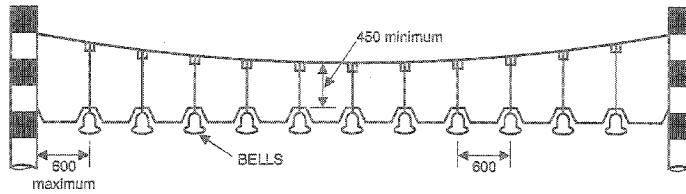

781  
Load gauge giving audible warning to drivers  
where vehicle exceeds safe height under electrified  
overhead cables

Item	
1	Regulations: 19(1)
2	Directions: 38
3	Diagrams: None
4	Permitted variants: Schedule 16, item 40
5	Illumination requirements: None

**Status:** This is the original version (as it was originally made). This item of legislation is currently only available in its original format.

SCHEDULE 3 SIGNS FOR RAILWAY AND TRAMWAY LEVEL CROSSINGS (contd.)

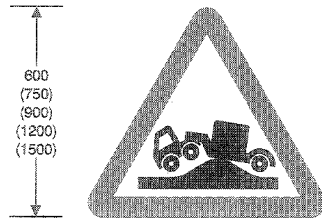

762  
Risk of grounding at a railway or tramway level crossing or hump backed bridge

Item	
1	Regulations: None
2	Directions: 19
3	Diagrams: 528, 572, 573
4	Permitted variants: None
5	Illumination requirements: Schedule 17, item 1

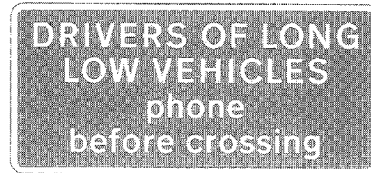

783  
Drivers of long low vehicles must obtain permission before using an automatic railway or tramway level crossing

Item	
1	Regulations: None
2	Directions: None
3	Diagrams: None
4	Permitted variants: "LONG LOW" may be varied to "LARGE OR SLOW"
5	Illumination requirements: Schedule 17, item 4

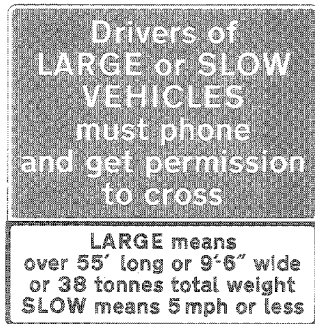

784  
Drivers of large or slow vehicles must stop and telephone before using an automatic railway or tramway level crossing

Item	
1	Regulations: 10(1), 10(2), 16
2	Directions: None
3	Diagrams: None
4	Permitted variants: None
5	Illumination requirements: Schedule 17, item 1



785  
Details of telephone number for contacting railway or tramway operator

Item	
1	Regulations: None
2	Directions: None
3	Diagrams: None
4	Permitted variants: "081-123 4567" shall be varied to the appropriate telephone number. "BR" may be varied to "RAILWAY" or "TRAM Co."
5	Illumination requirements: Schedule 17, item 4

Status: This is the original version (as it was originally made). This item of legislation is currently only available in its original format.

SCHEDULE 3 SIGNS FOR RAILWAY AND TRAMWAY LEVEL CROSSINGS (contd.)



786  
Place where large or slow vehicles should wait near an automatic railway or tramway level crossing while the driver obtains permission to cross

Item	
1	Regulations: None
2	Directions: None
3	Diagrams: None
4	Permitted variants: None
5	Illumination requirements: Schedule 17, item 4

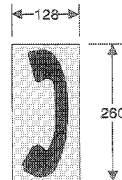

787  
Site of emergency telephone or telephone at or near a railway or tramway level crossing

Item	
1	Regulations: None
2	Directions: None
3	Diagrams: None
4	Permitted variants: None
5	Illumination requirements: Schedule 17, item 4

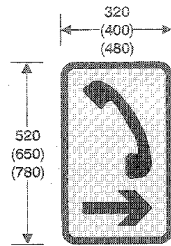

788  
Direction to emergency telephone or telephone at or near a railway or tramway level crossing

Item	
1	Regulations: None
2	Directions: None
3	Diagrams: None
4	Permitted variants: Schedule 16, item 13
5	Illumination requirements: Schedule 17, item 4

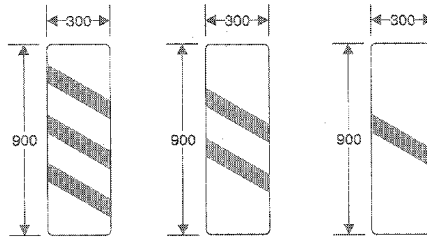

789, 789.1, 789.2  
Countdown markers to concealed railway or tramway level crossing

Item	
1	Regulations: None
2	Directions: None
3	Diagrams: None
4	Permitted variants: Schedule 16, item 28
5	Illumination requirements: Schedule 17, item 4



**Status:** This is the original version (as it was originally made). This item of legislation is currently only available in its original format.

SCHEDULE 3 SIGNS FOR RAILWAY AND TRAMWAY LEVEL CROSSINGS (contd.)

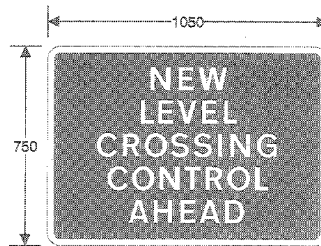

790  
New method of controlling traffic at a railway or tramway level crossing ahead

Item	
1	Regulations: None
2	Directions: 32
3	Diagrams: None
4	Permitted variants: None
5	Illumination requirements: Schedule 17, item 1

**Status:** This is the original version (as it was originally made). This item of legislation is currently only available in its original format.

SCHEDULE 4

Regulation 11(1)

OTHER INFORMATORY SIGNS

SCHEDULE 4  
OTHER INFORMATORY SIGNS

Regulation 11(1)

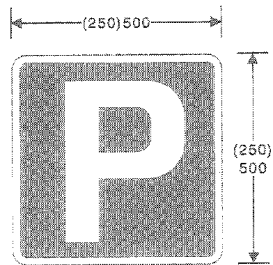

801  
Parking place

Item	
1	Regulations: None
2	Directions: 19, 23
3	Diagrams: 804.1, 804.2, 804.3, 1028.4, 1069
4	Permitted variants: None
5	Illumination requirements: Schedule 17, item 4

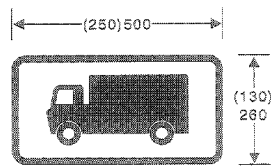

804.1  
Parking place for goods vehicles

Item	
1	Regulations: None
2	Directions: 7, 19
3	Diagrams: 801
4	Permitted variants: None
5	Illumination requirements: Schedule 17, item 8

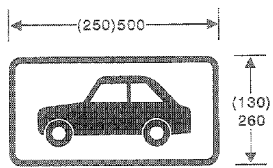

804.2  
Parking place for motor cars

Item	
1	Regulations: None
2	Directions: 7, 19
3	Diagrams: 801
4	Permitted variants: None
5	Illumination requirements: Schedule 17, item 8

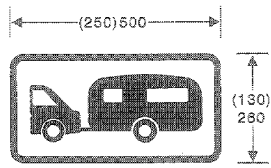

804.3  
Parking place for motorised caravans or caravans drawn by motor vehicles

Item	
1	Regulations: None
2	Directions: 7, 19
3	Diagrams: 801
4	Permitted variants: None
5	Illumination requirements: Schedule 17, item 8

**Status:** This is the original version (as it was originally made). This item of legislation is currently only available in its original format.

SCHEDULE 4 OTHER INFORMATORY SIGNS (contd.)



46  
(50)  
(60)

810  
One way traffic in direction indicated  
(Sign for pedestrians)

Item	
1	Regulations: None
2	Directions: 7
3	Diagrams: None
4	Permitted variants: Schedule 16, item 13
5	Illumination requirements: Schedule 17, item 9

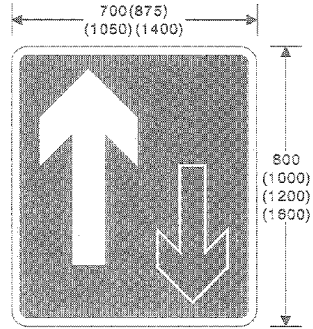

800  
(1000)  
(1200)  
(1500)

811  
Traffic has priority over vehicles from the opposite direction

Item	
1	Regulations: None
2	Directions: 17, 18, 19
3	Diagrams: 570, 615, 645, 811.1, 1043, 1044
4	Permitted variants: None
5	Illumination requirements: Schedule 17, item 4

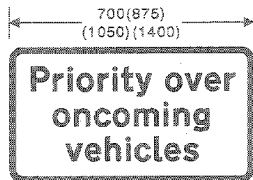

50  
(62.5)  
(75)  
(100)

811.1  
Explanatory plate for the sign shown in diagram 811

Item	
1	Regulations: None
2	Directions: 18, 19
3	Diagrams: 811
4	Permitted variants: None
5	Illumination requirements: Schedule 17, item 8

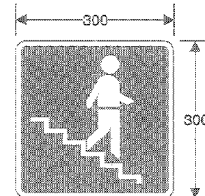

300

814.1  
Stepped entrance to pedestrian subway

Item	
1	Regulations: None
2	Directions: None
3	Diagrams: None
4	Permitted variants: None
5	Illumination requirements: Schedule 17, item 9

**Status:** This is the original version (as it was originally made). This item of legislation is currently only available in its original format.

SCHEDULE 4 OTHER INFORMATORY SIGNS (contd.)

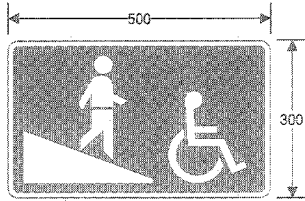

814.2  
Ramped entrance to pedestrian subway

Item	
1	Regulations: None
2	Directions: None
3	Diagrams: None
4	Permitted variants: The wheelchair symbol shall be omitted where the subway is not suitable for use by disabled people and the width of the sign reduced to 300mm
5	Illumination requirements: Schedule 17, item 9

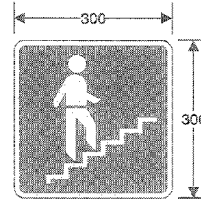

814.3  
Stepped approach to pedestrian overbridge

Item	
1	Regulations: None
2	Directions: None
3	Diagrams: None
4	Permitted variants: None
5	Illumination requirements: Schedule 17, item 9

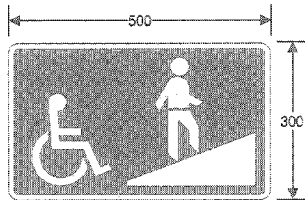

814.4  
Ramped approach to pedestrian overbridge

Item	
1	Regulations: None
2	Directions: None
3	Diagrams: None
4	Permitted variants: Same as diagram 814.2
5	Illumination requirements: Schedule 17, item 9

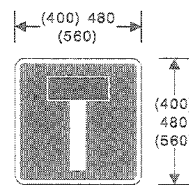

816  
No through road for vehicular traffic

Item	
1	Regulations: None
2	Directions: 19
3	Diagrams: 954.4
4	Permitted variants: None
5	Illumination requirements: Schedule 17, item 4

**Status:** This is the original version (as it was originally made). This item of legislation is currently only available in its original format.

SCHEDULE 4 OTHER INFORMATORY SIGNS (contd.)

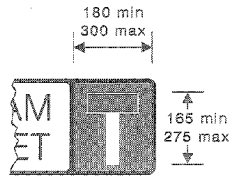

816.1  
Alternative to the sign shown in diagram 816 with a street nameplate

Item	
1	Regulations: None
2	Directions: None
3	Diagrams: None
4	Permitted variants: The blue panel need not extend to the edge of the name plate. The black border may be omitted
5	Illumination requirements: Schedule 17, item 9

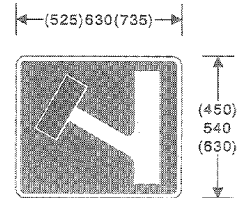

817  
No through road for vehicular traffic in direction indicated from junction ahead

Item	
1	Regulations: None
2	Directions: None
3	Diagrams: None
4	Permitted variants: Schedule 16, item 16
5	Illumination requirements: Schedule 17, item 4



817.2  
Escape lane ahead for vehicles unable to stop on steep hill

Item	
1	Regulations: None
2	Directions: 19
3	Diagrams: 528.1, 554.1
4	Permitted variants: Schedule 16, item 18 "ahead" may be varied to a distance or an arrow symbol.
5	Illumination requirements: Schedule 17, item 8

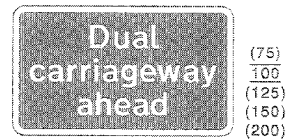

818  
Section of dual carriageway road begins directly ahead

Item	
1	Regulations: None
2	Directions: None
3	Diagrams: None
4	Permitted variants: None
5	Illumination requirements: Schedule 17, item 1

Status: This is the original version (as it was originally made). This item of legislation is currently only available in its original format.

SCHEDULE 4 OTHER INFORMATORY SIGNS (contd.)

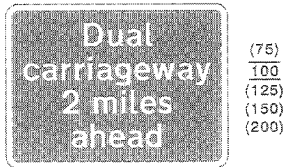

818.1  
Distance to a section of dual carriageway road ahead

Item	
1	Regulations: None
2	Directions: None
3	Diagrams: None
4	Permitted variants: Schedule 16, item 6
5	Illumination requirements: Schedule 17, item 1



818.1A  
Distance over which a short length of dual carriageway road beginning directly ahead extends

Item	
1	Regulations: None
2	Directions: None
3	Diagrams: None
4	Permitted variants: "1/2 mile" may be varied to "1/4 mile".
5	Illumination requirements: Schedule 17, item 1

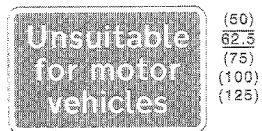

820  
Road unsuitable for type of vehicle indicated

Item	
1	Regulations: 22
2	Directions: None
3	Diagrams: None
4	Permitted variants: "motor vehicles" may be varied to 1. "caravans" 2. "heavy goods vehicles" 3. "wide vehicles" 4. "long vehicles" 5. "articulated vehicles" 6. "trailers" 7. "buses" 8. "buses and coaches"
5	Illumination requirements: Schedule 17, item 4

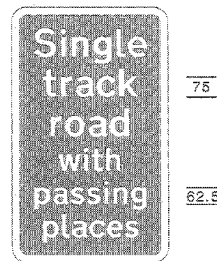

821  
Road ahead only wide enough for one line of vehicles, but has passing places at intervals

Item	
1	Regulations: None
2	Directions: None
3	Diagrams: None
4	Permitted variants: "with passing places" may be varied to "Use passing places to permit overtaking"
5	Illumination requirements: Schedule 17, item 4

**Status:** This is the original version (as it was originally made). This item of legislation is currently only available in its original format.

SCHEDULE 4 OTHER INFORMATORY SIGNS (contd.)

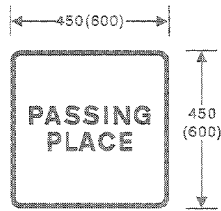

822  
Passing place on a narrow road

item	
1	Regulations: None
2	Directions: None
3	Diagrams: None
4	Permitted variants: None
5	Illumination requirements: Schedule 17, item 4

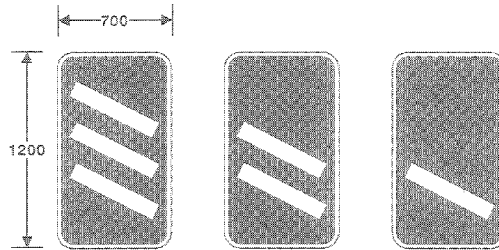

823                      824                      825

823, 824, 825  
Distance in hundreds of yards to a roundabout or the next point at which a driver may leave a motorway or other route

item	
1	Regulations: None
2	Directions: 14
3	Diagrams: None
4	Permitted variants: Schedule 16, item 28 Background colour shall be varied to green on primary routes, and white with black symbols and borders on non-primary routes.
5	Illumination requirements: Schedule 17, item 4

**Status:** This is the original version (as it was originally made). This item of legislation is currently only available in its original format.

SCHEDULE 4 OTHER INFORMATORY SIGNS (contd.)

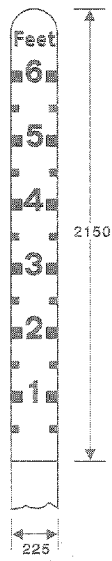

826  
Depth of water at a ford

Item	
1	Regulations: None
2	Directions: None
3	Diagrams: None
4	Permitted variants: None
5	Illumination requirements: Schedule 17, Item 9

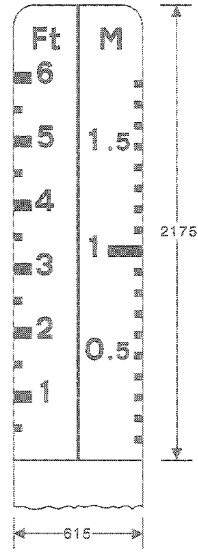

826.1  
As diagram 826, showing metric and imperial measurements

Item	
1	Regulations: None
2	Directions: None
3	Diagrams: None
4	Permitted variants: None
5	Illumination requirements: Schedule 17, Item 9



**Status:** This is the original version (as it was originally made). This item of legislation is currently only available in its original format.

SCHEDULE 4 OTHER INFORMATORY SIGNS (contd.)

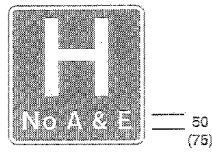

827.1  
Hospital ahead without  
accident and emergency facilities

Item	
1	Regulations: None
2	Directions: None
3	Diagrams: None
4	Permitted variants: None
5	Illumination requirements: Schedule 17, item 4

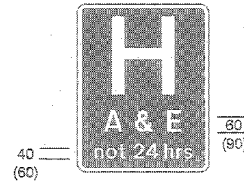

827.2  
Hospital ahead with  
accident and emergency facilities

Item	
1	Regulations: None
2	Directions: None
3	Diagrams: 901
4	Permitted variants: The legend "not 24 hrs" may be omitted
5	Illumination requirements: Schedule 17, item 4

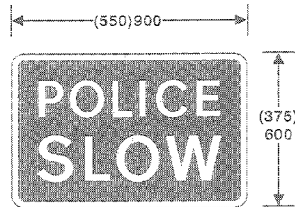

829.1  
Potential danger temporarily ahead  
and consequent need to proceed with caution

Item	
1	Regulations: 14, 42
2	Directions: 34(2)
3	Diagrams: None
4	Permitted variants: None
5	Illumination requirements: Schedule 17, item 4

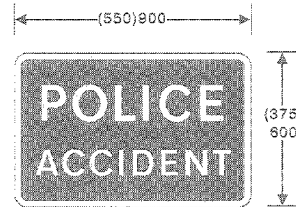

829.2  
Accident ahead and  
consequent need to proceed with caution

Item	
1	Regulations: 14, 42
2	Directions: 34(2)
3	Diagrams: None
4	Permitted variants: None
5	Illumination requirements: Schedule 17, item 4

**Status:** This is the original version (as it was originally made). This item of legislation is currently only available in its original format.

SCHEDULE 4 OTHER INFORMATORY SIGNS (contd.)

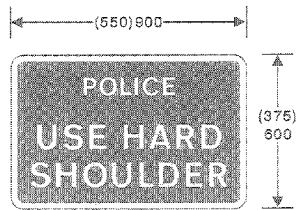

**829.3**  
Traffic should use the hard shoulder in an emergency

Item	
1	Regulations: 14, 42
2	Directions: 34(2)
3	Diagrams: None
4	Permitted variants: None
5	Illumination requirements: Schedule 17, item 4

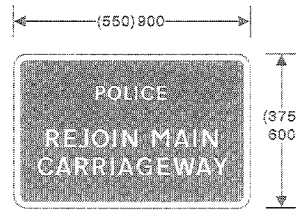

**829.4**  
End of temporary permission for traffic to use the hard shoulder

Item	
1	Regulations: 14, 42
2	Directions: 34(2)
3	Diagrams: None
4	Permitted variants: None
5	Illumination requirements: Schedule 17, item 4

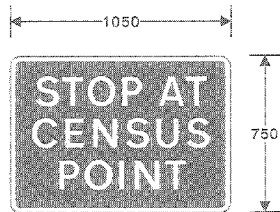

**830**  
Vehicles will be required to stop at a traffic survey

Item	
1	Regulations: None
2	Directions: 28
3	Diagrams: None
4	Permitted variants: "CENSUS POINT" may be varied to "WEIGHT CHECK"
5	Illumination requirements: Schedule 17, item 4

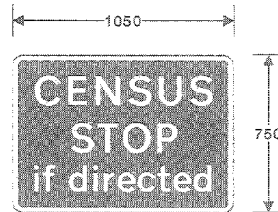

**830.1**  
Vehicles may be directed to stop at a traffic survey ahead

Item	
1	Regulations: None
2	Directions: 28
3	Diagrams: None
4	Permitted variants: "CENSUS" may be varied to "WEIGHT CHECK"
5	Illumination requirements: Schedule 17, item 4

**Status:** This is the original version (as it was originally made). This item of legislation is currently only available in its original format.

SCHEDULE 4 OTHER INFORMATORY SIGNS (contd.)

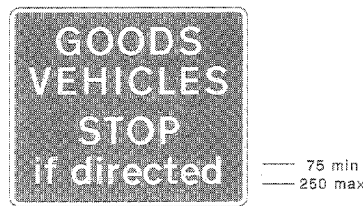

830.2  
Goods vehicles may be directed to stop ahead by a police officer in uniform for the purposes of sections 67, 68 or 78 of the Road Traffic Act 1988

Item	
1	Regulations: None
2	Directions: None
3	Diagrams: None
4	Permitted variants: None
5	Illumination requirements: Schedule 17, item 4

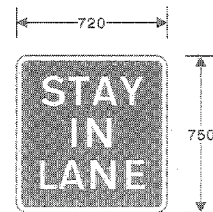

830.3  
Vehicles should stay in lane for the purposes of a traffic survey or weight check ahead

Item	
1	Regulations: None
2	Directions: 28
3	Diagrams: None
4	Permitted variants: "STAY" may be varied to "GET"
5	Illumination requirements: Schedule 17, item 4

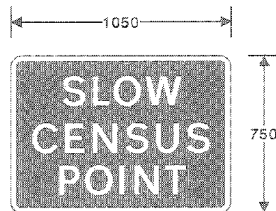

831  
Vehicles should reduce speed on approaching a traffic survey ahead

Item	
1	Regulations: None
2	Directions: 28
3	Diagrams: None
4	Permitted variants: Same as diagram 830
5	Illumination requirements: Schedule 17, item 4

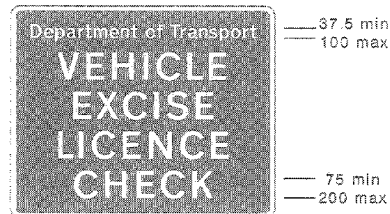

831.1  
Vehicle excise licence check point ahead

Item	
1	Regulations: None
2	Directions: None
3	Diagrams: None
4	Permitted variants: None
5	Illumination requirements: Schedule 17, item 4

**Status:** This is the original version (as it was originally made). This item of legislation is currently only available in its original format.

SCHEDULE 4 OTHER INFORMATORY SIGNS (contd.)

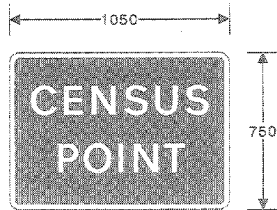

832  
Location of traffic survey

Item	
1	Regulations: None
2	Directions: 28
3	Diagrams: None
4	Permitted variants: Same as diagram 830
5	Illumination requirements: Schedule 17, item 4

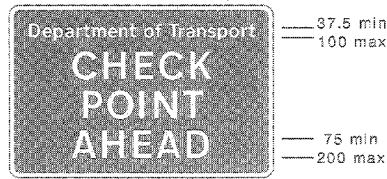

832.1  
Vehicle check point ahead

Item	
1	Regulations: None
2	Directions: None
3	Diagrams: None
4	Permitted variants: "Department of Transport" may be varied to "GOODS VEHICLE"
5	Illumination requirements: Schedule 17, item 4

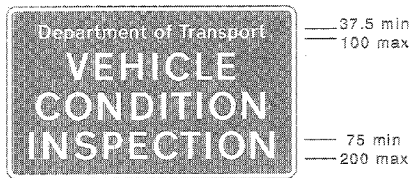

832.2  
Vehicle condition check point ahead

Item	
1	Regulations: None
2	Directions: None
3	Diagrams: None
4	Permitted variants: None
5	Illumination requirements: Schedule 17, item 4

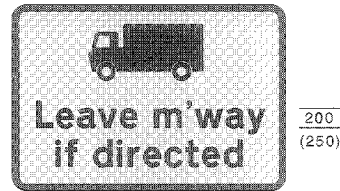

832.3  
Goods vehicles may be directed to leave the motorway at a junction ahead

Item	
1	Regulations: 24
2	Directions: 13(1)
3	Diagrams: None
4	Permitted variants: The bus symbol shown in diagram 952 may be added below the lorry symbol
5	Illumination requirements: Schedule 17, item 4

**Status:** This is the original version (as it was originally made). This item of legislation is currently only available in its original format.

SCHEDULE 4 OTHER INFORMATORY SIGNS (contd.)

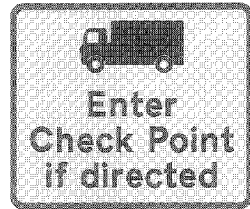

100 min  
250 max

832.4

Goods vehicles may be directed to enter a check point ahead

Item	
1	Regulations: 24
2	Directions: None
3	Diagrams: None
4	Permitted variants: The bus symbol shown in diagram 952 may be added below the lorry symbol.
5	Illumination requirements: Schedule 17, item 4

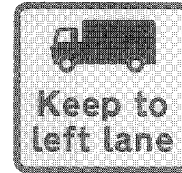

100 min  
250 max

832.5

Goods vehicles should keep to left hand lane on the approach to check point ahead

Item	
1	Regulations: 24
2	Directions: None
3	Diagrams: None
4	Permitted variants: The bus symbol shown in diagram 952 may be added below the lorry symbol.
5	Illumination requirements: Schedule 17, item 4

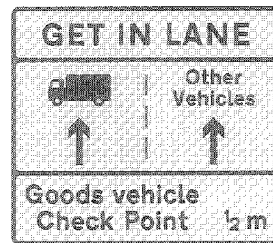

150 min  
240 max

100 min  
160 max

125 min  
200 max

832.6

Goods vehicles should get into the left hand lane and other vehicles should use the right hand lane of a 2 lane carriageway on the approach to a goods vehicle check point ahead

Item	
1	Regulations: 24
2	Directions: None
3	Diagrams: None
4	Permitted variants: Schedule 16, item 7 An additional lane may be indicated on the right hand side of the centre panel of the sign. "GET IN LANE" may be varied to "STAY IN LANE". The word "Goods" may be varied to "Commercial". The bus symbol shown in diagram 952 may be added below the lorry symbol.
5	Illumination requirements: Schedule 17, item 4

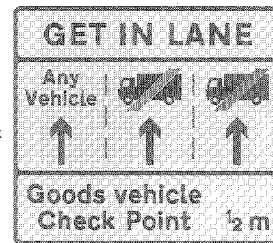

150 min  
240 max

100 min  
160 max

125 min  
200 max

832.7

Goods vehicles should get into the left hand lane of a 3 lane carriageway on the approach to a goods vehicle check point ahead

Item	
1	Regulations: 24
2	Directions: None
3	Diagrams: None
4	Permitted variants: Schedule 16, item 7 The right hand lane may be omitted. "GET IN LANE" may be varied to "STAY IN LANE". The word "Goods" may be varied to "Commercial". The bus symbol shown in diagram 952 with a red diagonal bar may be added below the lorry symbol.
5	Illumination requirements: Schedule 17, item 4

**Status:** This is the original version (as it was originally made). This item of legislation is currently only available in its original format.

SCHEDULE 4 OTHER INFORMATORY SIGNS (contd.)

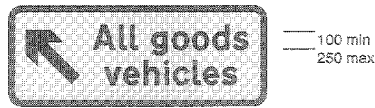

832.8  
Goods vehicles should leave the main carriageway of a road on the approach to a goods vehicle check point

Item	
1	Regulations: None
2	Directions: None
3	Diagrams: None
4	Permitted variants: The word "goods" may be varied to "commercial"
5	Illumination requirements: Schedule 17, item 4



832.9  
Direction to a commercial vehicle check point

Item	
1	Regulations: None
2	Directions: None
3	Diagrams: None
4	Permitted variants: Schedule 16, item 15
5	Illumination requirements: Schedule 17, item 4



832.10  
End of goods vehicle check point area

Item	
1	Regulations: None
2	Directions: None
3	Diagrams: None
4	Permitted variants: The word "Goods" may be varied to "Commercial"
5	Illumination requirements: Schedule 17, item 4

**Status:** This is the original version (as it was originally made). This item of legislation is currently only available in its original format.

SCHEDULE 4 OTHER INFORMATORY SIGNS (contd.)

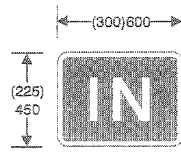

833  
Entrance to a private access road or property

Item	
1	Regulations: None
2	Directions: 29
3	Diagrams: None
4	Permitted variants: None
5	Illumination requirements: Schedule 17, item 9

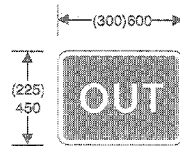

834  
Exit from a private access road or property

Item	
1	Regulations: None
2	Directions: 29
3	Diagrams: None
4	Permitted variants: None
5	Illumination requirements: Schedule 17, item 9

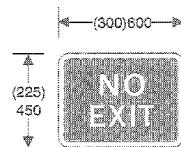

835  
Exit from a private access road or property  
to a public road not allowed

Item	
1	Regulations: None
2	Directions: 29
3	Diagrams: None
4	Permitted variants: None
5	Illumination requirements: Schedule 17, item 9

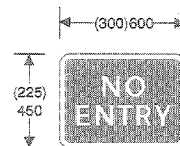

836  
Entry to a private access road or property  
from a public road not allowed

Item	
1	Regulations: None
2	Directions: 29
3	Diagrams: None
4	Permitted variants: None
5	Illumination requirements: Schedule 17, item 9

Status: This is the original version (as it was originally made). This item of legislation is currently only available in its original format.

SCHEDULE 4 OTHER INFORMATORY SIGNS (contd.)

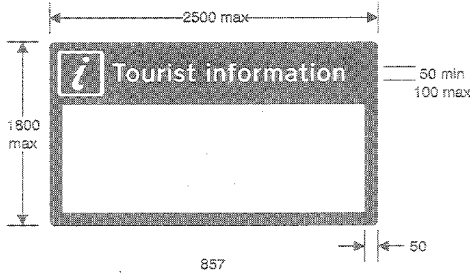

857  
Information about tourist attractions and facilities in a nearby place or area

Item	
1	Regulations: None
2	Directions: None
3	Diagrams: None
4	Permitted variants: The white area is to be filled with maps and/or legend in any colour with lettering not exceeding 25mm in height. The "i" symbol and/or the word "Tourist" may be omitted. The logo of a local tourist organisation may be added at the top of the sign. The colour of the border shall be varied to blue when the sign is not used as a Tourist Information Point. The sign may have more than one panel or side, each of the design prescribed in this diagram.
5	Illumination requirements: Schedule 17, item 9

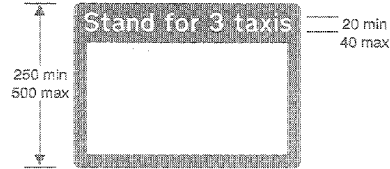

857.1  
Information relating to a taxi rank for the number of taxis specified

Item	
1	Regulations: None
2	Directions: None
3	Diagrams: 650.1, 650.2, 1028.2
4	Permitted variants: The number of taxis indicated may be varied as appropriate. Information relating to the taxi services from that rank may be shown in the white space in lettering of any colour with a letter height not exceeding 25mm, or the white space may be omitted.
5	Illumination requirements: Schedule 17, item 9

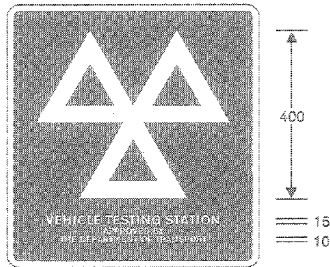

864  
Vehicle testing station approved by the Department of Transport

Item	
1	Regulations: None
2	Directions: None
3	Diagrams: None
4	Permitted variants: None
5	Illumination requirements: Schedule 17, item 9



865  
Motorcycle test centre

Item	
1	Regulations: None
2	Directions: None
3	Diagrams: None
4	Permitted variants: None
5	Illumination requirements: Schedule 17, item 9



**Status:** This is the original version (as it was originally made). This item of legislation is currently only available in its original format.

SCHEDULE 4 OTHER INFORMATORY SIGNS (contd.)

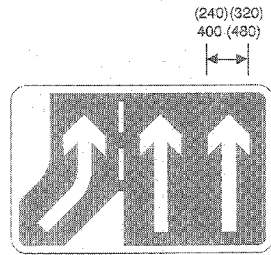

868  
Additional traffic lane joining from the left ahead

Item	
1	Regulations: None
2	Directions: 14, 18
3	Diagrams: 876
4	Permitted variants: Schedule 16, item 16 Background colour to be varied to blue with white symbols on motorways and white with black symbols and border on non-primary routes.
5	Illumination requirements: Schedule 17, item 1

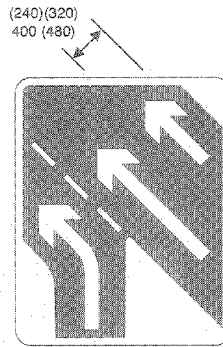

668.1  
Additional traffic lanes joining from the right ahead

Item	
1	Regulations: None
2	Directions: 14, 19
3	Diagrams: 876
4	Permitted variants: Schedule 16, item 16 Same as diagram 868
5	Illumination requirements: Schedule 17, item 1

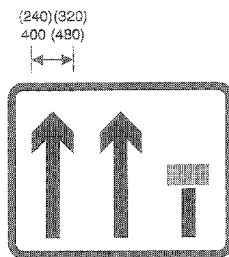

872  
Number of traffic lanes reduced ahead

Item	
1	Regulations: None
2	Directions: 14, 19
3	Diagrams: 876
4	Permitted variants: Schedule 16, item 16 Background colour to be varied to blue with white symbols and border on motorways and green with white symbols and border on primary routes
5	Illumination requirements: Schedule 17, item 1

**Status:** This is the original version (as it was originally made). This item of legislation is currently only available in its original format.

SCHEDULE 4 OTHER INFORMATORY SIGNS (contd.)

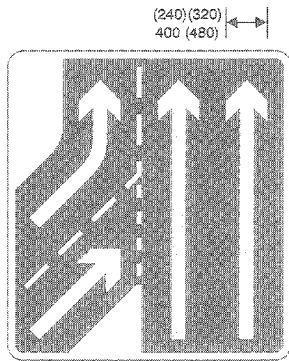

873  
Additional traffic lane joining from the left ahead.  
Traffic on main carriageway has priority over joining traffic from the right hand lane of the slip road

item	
1	Regulations: None
2	Directions: 14, 19
3	Diagrams: 876
4	Permitted variants: Schedule 16, item 16 Background colour to be varied to green with white symbols and border on primary routes and white with black symbols and border on non-primary routes
5	Illumination requirements: Schedule 17, item 1

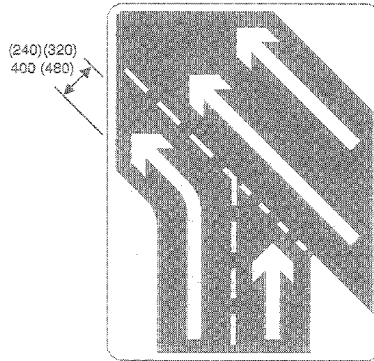

874  
Additional traffic lanes joining from the right ahead.  
Traffic in the right hand lane joins the main carriageway.  
Traffic on the main carriageway has priority over joining traffic

item	
1	Regulations: None
2	Directions: 14, 19
3	Diagrams: 876
4	Permitted variants: Schedule 16, item 16 Same as diagram 873
5	Illumination requirements: Schedule 17, item 1

**Status:** This is the original version (as it was originally made). This item of legislation is currently only available in its original format.

SCHEDULE 4 OTHER INFORMATORY SIGNS (contd.)

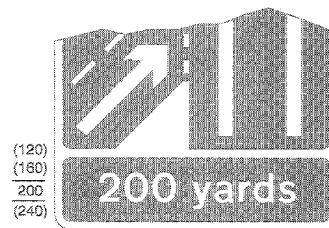
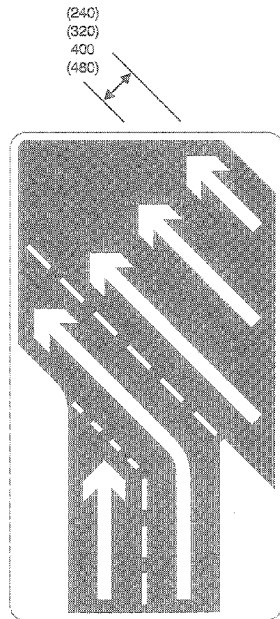

875

Additional traffic lanes joining from the right ahead.  
Traffic in the right hand lane of the slip road has priority over traffic in the left hand lane

Item	
1	Regulations: None
2	Directions: 14, 19
3	Diagrams: 876
4	Permitted variants: Schedule 16, Item 16 Same as diagram 873
5	Illumination requirements: Schedule 17, Item 1

876

Distance to the change in the number of lanes indicated by the signs shown in diagrams 868 to 875

Item	
1	Regulations: None
2	Directions: 14, 19
3	Diagrams: 868, 868.1, 872, 873, 874, 875
4	Permitted variants: Schedule 16, Item 6 Same as diagram 873
5	Illumination requirements: Schedule 17, Item 6

**Status:** This is the original version (as it was originally made). This item of legislation is currently only available in its original format.

SCHEDULE 4 OTHER INFORMATORY SIGNS (contd.)

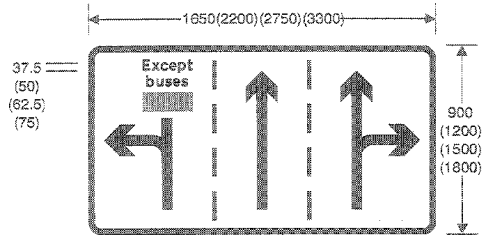

677

Junction ahead where the left hand lane is dedicated to traffic turning left and must not be used by other traffic except buses and where the right hand lane is available both for traffic proceeding ahead and turning right

Item	
1	Regulations: 22(1)
2	Directions: 14
3	Diagrams: None
4	Permitted variants: Schedule 16, item 16 The background colour shall be varied to green with white symbols and border on primary routes. The words "Except buses" may be omitted.
5	Illumination requirements: Schedule 17, item 4

**Status:** This is the original version (as it was originally made). This item of legislation is currently only available in its original format.

SCHEDULE 5

Regulation 11(1)

SIGNS FOR BUS, TRAM AND PEDAL CYCLES FACILITIES

SCHEDULE 5

Regulation 11(1)

SIGNS FOR BUS, TRAM AND PEDAL CYCLE FACILITIES

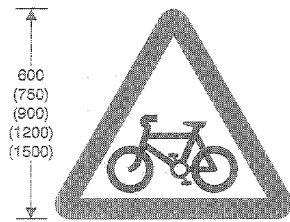

950  
Cycle route ahead

Item	
1	Regulations: None
2	Directions: 19, 34(4)
3	Diagrams: 572, 573, 950.1
4	Permitted variants: Schedule 16, item 23
5	Illumination requirements: Schedule 17, items 1, 4



950.1  
Training or testing of child cyclists ahead

Item	
1	Regulations: None
2	Directions: 19, 34(4)
3	Diagrams: 950
4	Permitted variants: "tests" may be varied to "training"
5	Illumination requirements: Schedule 17, item 8

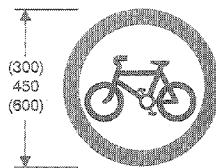

951  
Riding of pedal cycles prohibited

Item	
1	Regulations: None
2	Directions: 7, 8
3	Diagrams: None
4	Permitted variants: None
5	Illumination requirements: Schedule 17, item 4

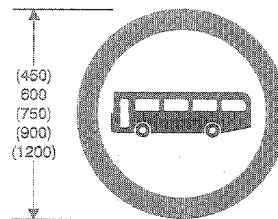

952  
Buses prohibited

Item	
1	Regulations: 24(1)
2	Directions: 7, 8, 19
3	Diagrams: 620, 954.2 after 1.1.87
4	Permitted variants: None
5	Illumination requirements: Schedule 17, item 1

**Status:** This is the original version (as it was originally made). This item of legislation is currently only available in its original format.

SCHEDULE 5 SIGNS FOR BUS, TRAM AND PEDAL CYCLE FACILITIES (contd.)

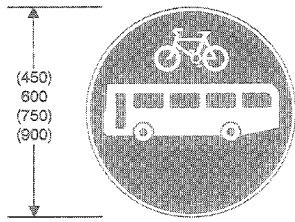

953  
Route for use by buses and pedal cycles only

Item	
1	Regulations: 10(1), 24
2	Directions: 7, 8, 18, 19
3	Diagrams: 953.2
4	Permitted variants: The word "local" in black letters may be placed on the bus symbol. The cycle symbol may be omitted. The word "taxi" in white letters may be added below the bus symbol.
5	Illumination requirements: Schedule 17, item 1

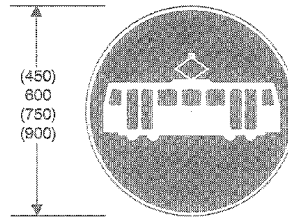

953.1  
Route for use by tramcars only

Item	
1	Regulations: 10(1), 24
2	Directions: 7, 8, 18, 19
3	Diagrams: 953.2
4	Permitted variants: The bus symbol shown in diagram 953 may be added below the tramcar symbol.
5	Illumination requirements: Schedule 17, item 1



953.2  
Explanatory plate for the signs shown in diagrams 953 and 953.1

Item	
1	Regulations: None
2	Directions: 7, 18, 19
3	Diagrams: 953, 953.1
4	Permitted variants: None
5	Illumination requirements: Schedule 17, item 5



954  
Buses excluded from restriction or prohibition conveyed by associated sign

Item	
1	Regulations: 22
2	Directions: 7, 19
3	Diagrams: 606, 609, 612, 613, 616, 629, 629.1
4	Permitted variants: None
5	Illumination requirements: Schedule 17, item 8

**Status:** This is the original version (as it was originally made). This item of legislation is currently only available in its original format.

SCHEDULE 5 SIGNS FOR BUS, TRAM AND PEDAL CYCLE FACILITIES (contd.)



954.1  
Same as diagram 954 applying to buses and coaches

Item	
1	Regulations: 22
2	Directions: 7, 19
3	Diagrams: 606, 609, 612, 613, 616, 629, 629.1
4	Permitted variants: The legend may be on three lines
5	Illumination requirements: Schedule 17, item 8



954.2  
Same as diagram 954 applying to local buses

Item	
1	Regulations: 22
2	Directions: 7, 19
3	Diagrams: 606, 609, 612, 613, 616, 629, 629.1, 952
4	Permitted variants: The legend may be on three lines
5	Illumination requirements: Schedule 17, item 8

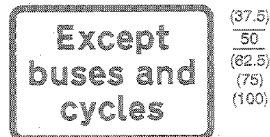

954.3  
Same as diagram 954 applying to buses and pedal cycles

Item	
1	Regulations: 22
2	Directions: 7, 19
3	Diagrams: 606, 609, 612, 613
4	Permitted variants: The word "local" may be added before "buses"
5	Illumination requirements: Schedule 17, item 8



954.4  
Same as diagram 954 applying to pedal cycles

Item	
1	Regulations: None
2	Directions: 7, 19
3	Diagrams: 606, 609, 612, 613, 616
4	Permitted variants: None
5	Illumination requirements: Schedule 17, item 8

**Status:** This is the original version (as it was originally made). This item of legislation is currently only available in its original format.

SCHEDULE 5 SIGNS FOR BUS, TRAM AND PEDAL CYCLE FACILITIES (contd.)

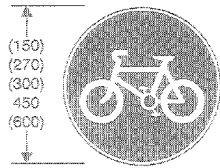

955  
Route for use by pedal cycles only

Item	
1	Regulations: None
2	Directions: 7, 8, 16
3	Diagrams: 1057
4	Permitted variants: None
5	Illumination requirements: Schedule 17, item 3, 7

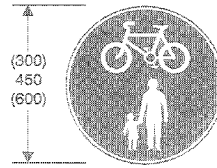

956  
Route for use by pedal cycles and pedestrians only

Item	
1	Regulations: None
2	Directions: 7, 8, 10, 16
3	Diagrams: 1037
4	Permitted variants: None
5	Illumination requirements: Schedule 17, item 3

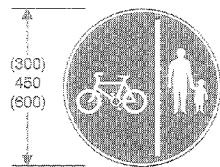

957  
Route comprising two ways, separated by the marking shown in diagram 1049 or 1049.1 or by physical means, for use by pedal cycles only and by pedestrians only

Item	
1	Regulations: None
2	Directions: 7, 8, 10, 15, 16, 30
3	Diagrams: 1049, 1049.1, 1057
4	Permitted variants: Symbols may be reversed in a mirror image
5	Illumination requirements: Schedule 17, item 3

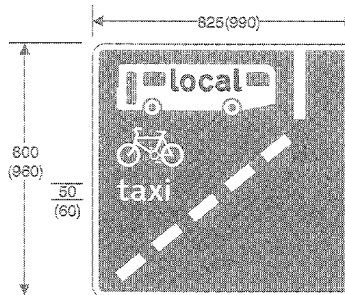

958  
With-flow bus lane ahead

Item	
1	Regulations: 23, 24
2	Directions: 7, 19
3	Diagrams: 981
4	Permitted variants: The word "taxi" may be omitted. The legend "local" may be omitted or varied to "& coaches".
5	Illumination requirements: Schedule 17, item 4



**Status:** This is the original version (as it was originally made). This item of legislation is currently only available in its original format.

SCHEDULE 5 SIGNS FOR BUS, TRAM AND PEDAL CYCLE FACILITIES (contd.)

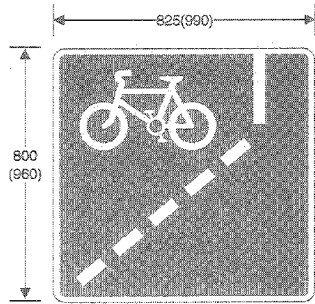

958.1  
With-flow cycle lane ahead

Item	
1	Regulations: None
2	Directions: 7, 19
3	Diagrams: 961
4	Permitted variants: None
5	Illumination requirements: Schedule 17, item 4

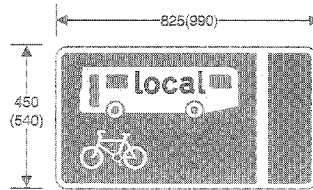

959  
With-flow bus lane which pedal cycles may also use  
Note: Any vehicle may enter the bus lane to stop, load or unload where this is not prohibited

Item	
1	Regulations: 23, 24
2	Directions: 7, 10, 15, 16, 19
3	Diagrams: 961, 1048, 1049
4	Permitted variants: The word "local" may be omitted or varied to the legend "& coaches". The word "taxi" in white letters may be added alongside the cycle symbol.
5	Illumination requirements: Schedule 17, item 4

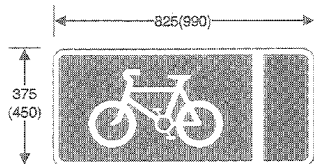

959.1  
With-flow cycle lane

Item	
1	Regulations: None
2	Directions: 7, 10, 15, 16, 19
3	Diagrams: 961, 1049, 1057
4	Permitted variants: None
5	Illumination requirements: Schedule 17, item 4

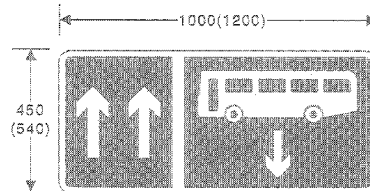

980  
Contra-flow bus lane  
Note: Any vehicle may enter the bus lane to stop, load or unload where this is not prohibited

Item	
1	Regulations: 12(8), 23, 24
2	Directions: 7, 10, 15, 16
3	Diagrams: 1048, 1048.1, 1049
4	Permitted variants: Schedule 16, item 16 The cycle symbol shown in diagram 955 may be added below the bus symbol. The legend "local" or "& coaches" in black may be placed on the bus symbol
5	Illumination requirements: Schedule 17, item 4

**Status:** This is the original version (as it was originally made). This item of legislation is currently only available in its original format.

SCHEDULE 5 SIGNS FOR BUS, TRAM AND PEDAL CYCLE FACILITIES (contd.)

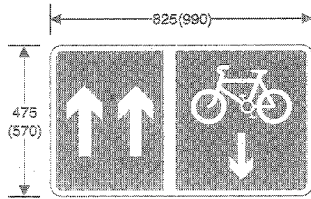

980.1  
Contra-flow cycle lane

Item	
1	Regulations: 12(8)
2	Directions: 7, 10, 15, 16
3	Diagrams: 1049, 1057
4	Permitted variants: Schedule 16, item 16
5	Illumination requirements: Schedule 17, item 4

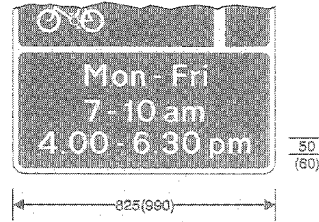

981  
Times of operation of a bus lane or a cycle lane

Item	
1	Regulations: None
2	Directions: 7, 10, 19
3	Diagrams: 958, 958.1, 959, 959.1
4	Permitted variants: Schedule 16, item 37
5	Illumination requirements: Schedule 17, item 8

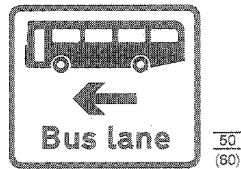

982  
Bus lane on road at junction ahead

Item	
1	Regulations: 23, 24
2	Directions: 7
3	Diagrams: None
4	Permitted variants: Schedule 16, items 13, 14, 28, 38 Where the arrow is omitted the word "lane" shall be varied to "lanes". When the arrow is reversed the symbol must be reversed.
5	Illumination requirements: Schedule 17, item 4

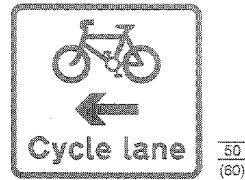

982.1  
Cycle lane on road at junction ahead or cycle track crossing road

Item	
1	Regulations: None
2	Directions: 7
3	Diagrams: None
4	Permitted variants: Schedule 16, items 13, 14, 28, 38 "lane" may be varied to "track". Where the arrow is omitted "lane" shall be varied to "lanes", "track" or "tracks". When the arrow is reversed the symbol must be reversed.
5	Illumination requirements: Schedule 17, item 4

**Status:** This is the original version (as it was originally made). This item of legislation is currently only available in its original format.

SCHEDULE 5 SIGNS FOR BUS, TRAM AND PEDAL CYCLE FACILITIES (contd.)

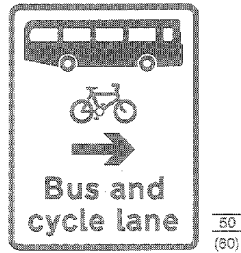

(40)  
50  
(80)

962.2  
Contra-flow bus lane which pedal cycles may also use on road at junction ahead

Item	
1	Regulations: 23, 24
2	Directions: 7
3	Diagrams: None
4	Permitted variants: Schedule 16, items 13, 14, 28, 38 Where the arrow is omitted the word "lane" shall be varied to "lanes" and the symbols reversed.
5	Illumination requirements: Schedule 17, item 4

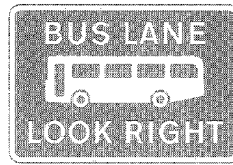

(40)  
50

963  
Bus lane with traffic proceeding from right  
(Sign for pedestrians)

Item	
1	Regulations: 23, 24
2	Directions: 7
3	Diagrams: None
4	Permitted variants: Schedule 16, item 28 "RIGHT" may be varied to "LEFT" or "BOTH WAYS". "LANE" may be varied to "LANES".
5	Illumination requirements: Schedule 17, item 9



(40)  
50

963.1  
Cycle lane with traffic proceeding from right  
(Sign for pedestrians)

Item	
1	Regulations: None
2	Directions: 7
3	Diagrams: None
4	Permitted variants: Schedule 16, item 28 "RIGHT" may be varied to "LEFT" or "BOTH WAYS". "LANE" may be varied to "LANES" or "TRACK".
5	Illumination requirements: Schedule 17, item 9

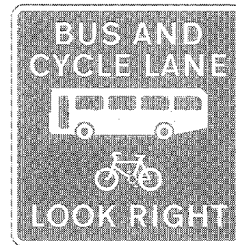

(40)  
50

963.2  
Contra-flow bus lane which pedal cycles may also use with traffic proceeding from right  
(Sign for pedestrians)

Item	
1	Regulations: 23, 24
2	Directions: 7
3	Diagrams: None
4	Permitted variants: Schedule 16, item 28 "RIGHT" may be varied to "LEFT" or "BOTH WAYS". "LANE" may be varied to "LANES".
5	Illumination requirements: Schedule 17, item 9

**Status:** This is the original version (as it was originally made). This item of legislation is currently only available in its original format.

SCHEDULE 5 SIGNS FOR BUS, TRAM AND PEDAL CYCLE FACILITIES (contd.)

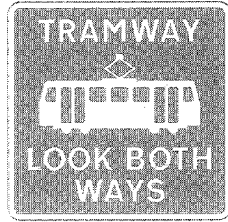

(40)  
50

963.3  
Tramway with traffic proceeding in both directions  
(Sign for pedestrians)

Item	
1	Regulations: None
2	Directions: 7
3	Diagrams: None
4	Permitted variants: "BOTH WAYS" may be varied to "LEFT" or "RIGHT"
5	Illumination requirements: Schedule 17, item 9



50  
(60)

964  
The end of a bus lane

Item	
1	Regulations: 23(1)
2	Directions: 7, 9, 16
3	Diagrams: 1050
4	Permitted variants: None
5	Illumination requirements: Schedule 17, item 4

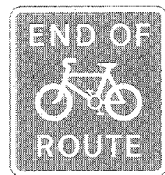

(40)  
50

965  
The end of a cycle lane, track or route

Item	
1	Regulations: None
2	Directions: None
3	Diagrams: 1057, 1058
4	Permitted variants: None
5	Illumination requirements: Schedule 17, item 9



40  
(50)

966  
Pedal cyclists to dismount at the end of, or at a break in, a cycle lane, track or route

Item	
1	Regulations: None
2	Directions: None
3	Diagrams: None
4	Permitted variants: None
5	Illumination requirements: Schedule 17, item 9

**Status:** This is the original version (as it was originally made). This item of legislation is currently only available in its original format.

SCHEDULE 5 SIGNS FOR BUS, TRAM AND PEDAL CYCLE FACILITIES (contd.)

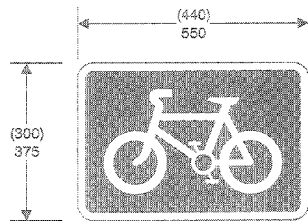

967  
Route recommended for pedal cycles

Item	
1	Regulations: None
2	Directions: 16
3	Diagrams: 1004, 1004.1, 1057
4	Permitted variants: None
5	Illumination requirements: Schedule 17, item 9

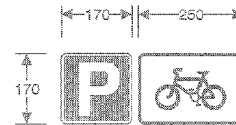

968  
Parking place for pedal cycles

Item	
1	Regulations: None
2	Directions: None
3	Diagrams: None
4	Permitted variants: None
5	Illumination requirements: Schedule 17, item 9

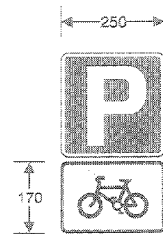

968.1  
Same as diagram 968

Item	
1	Regulations: None
2	Directions: None
3	Diagrams: None
4	Permitted variants: None
5	Illumination requirements: Schedule 17, item 9

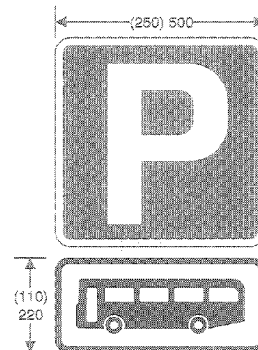

969  
Parking place for buses

Item	
1	Regulations: 24(1)
2	Directions: 7, E5
3	Diagrams: 1028.2
4	Permitted variants: None
5	Illumination requirements: Schedule 17, item 4

**Status:** This is the original version (as it was originally made). This item of legislation is currently only available in its original format.

SCHEDULE 5 SIGNS FOR BUS, TRAM AND PEDAL CYCLE FACILITIES (contd.)

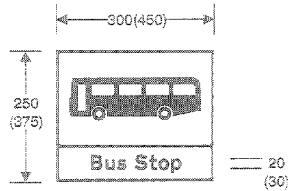

970  
Stopping place for buses

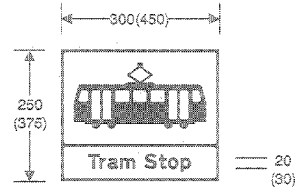

971  
Stopping place for tramcars

Item	
1	Regulations: 22, 24(1)
2	Directions: 36, 37
3	Diagrams: 1025, 1025.1, 1025.2, 1025.3
4	Permitted variants: See note "Bus" may be varied to "Request" "Stop" may be varied to "Stand"
5	Illumination requirements: Schedule 17, item 9

Item	
1	Regulations: None
2	Directions: 36, 37
3	Diagrams: None
4	Permitted variants: See note under diagram 970. "Tram" may be varied to "Request"
5	Illumination requirements: Schedule 17, item 9

Diagrams 970 - 973.1 Note: Supplementary plates may be added to give additional information

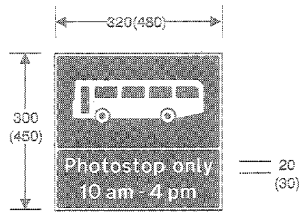

972  
Stopping place for buses used for carrying tourists  
to allow passengers to take photographs

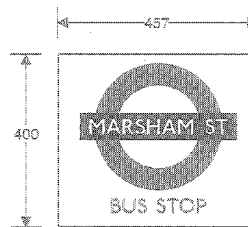

973  
Stopping place for buses operated by or on behalf of  
or under an agreement with London Regional  
Transport

Item	
1	Regulations: 24(1)
2	Directions: 36, 37
3	Diagrams: None
4	Permitted variants: See note under diagram 970. Schedule 18, item 37 Times may be omitted
5	Illumination requirements: Schedule 17, item 9

Item	
1	Regulations: 13, 22
2	Directions: 36, 37
3	Diagrams: 1025, 1025.1, 1025.2, 1025.3
4	Permitted variants: See note under diagram 970. The name of the stop may be varied to "BUS STOP" or omitted in which case the cross bar shall be red. The lettering at the bottom of the sign may be omitted or varied to black. The word "STOP" may be varied to "STAND".
5	Illumination requirements: Schedule 17, item 9

**Status:** This is the original version (as it was originally made). This item of legislation is currently only available in its original format.

SCHEDULE 5 SIGNS FOR BUS, TRAM AND PEDAL CYCLE FACILITIES (contd.)

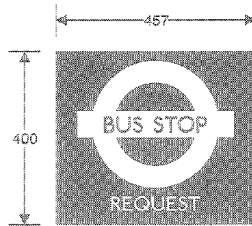

973.1  
Same as diagram 973

Item	
1	Regulations: 13, 22
2	Directions: 33, 37
3	Diagrams: 1025, 1025.1, 1025.2, 1025.3
4	Permitted variants: See note under diagram 970. The words "BUS STOP" may be varied to "REQUEST" or the name of the stop as shown in diagram 973 or omitted. The lettering on the cross bar may be varied to black. The word "REQUEST" on the lower part of the sign may be omitted or varied to "REQUEST STOP" or "BUS STOP".
5	Illumination requirements: Schedule 17, item 9

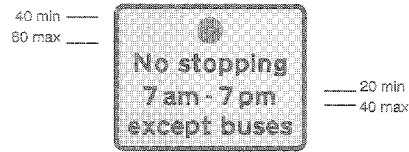

974  
Stopping by vehicles other than buses prohibited during periods indicated

Item	
1	Regulations: 22
2	Directions: 7, 22, 23
3	Diagrams: 1025.1, 1025.3
4	Permitted variants: Schedule 16, item 37
5	Illumination requirements: Schedule 17, item 9



975  
Place where buses may stand and the stopping of other vehicles is prohibited during periods indicated

Item	
1	Regulations: 22
2	Directions: 7, 22, 23
3	Diagrams: 1025.1, 1025.3
4	Permitted variants: Schedule 16, item 37
5	Illumination requirements: Schedule 17, item 9

**Status:** This is the original version (as it was originally made). This item of legislation is currently only available in its original format.

SCHEDULE 6

Regulation 11

ROAD MARKINGS

SCHEDULE 6  
ROAD MARKINGS

Regulation 11

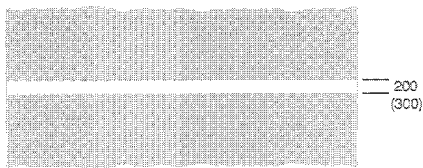

1001  
Vehicular traffic must not proceed beyond the line when required to stop by light signals or by a police constable in uniform or a traffic warden

Item	
1	Regulations: 28, 33, 38
2	Directions: 16, 42
3	Diagrams: 3000, 3000.1, 3000.2, 3000.3, 3000.4, 3000.5, 3000.8, 3013, 3014
4	Permitted variants: None
5	Illumination requirements: Schedule 17, item 12

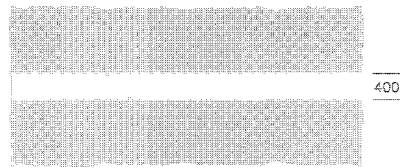

1002.1  
Vehicular traffic must not proceed beyond the line when required to stop by the sign shown in diagram 601.1

Item	
1	Regulations: 16, 28
2	Directions: 15, 16
3	Diagrams: 601.1, 1022
4	Permitted variants: None
5	Illumination requirements: Schedule 17, item 12

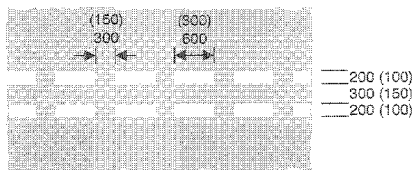

1003  
Vehicular traffic must give way in accordance with the requirements of regulation 25

Item	
1	Regulations: 4, 10(1), 16, 25, 28
2	Directions: 15, 16
3	Diagrams: 602, 611.1, 615, 1003.4, 1023
4	Permitted variants: None
5	Illumination requirements: Schedule 17, item 12

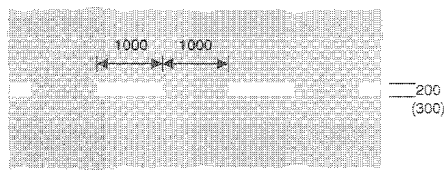

1003.1  
Vehicular traffic approaching a roundabout should give way at or immediately beyond the line to vehicular traffic circulating on the carriageway of the roundabout

Item	
1	Regulations: 28
2	Directions: None
3	Diagrams: None
4	Permitted variants: None
5	Illumination requirements: Schedule 17, item 12



**Status:** This is the original version (as it was originally made). This item of legislation is currently only available in its original format.

SCHEDULE 8 ROAD MARKINGS (contd.)

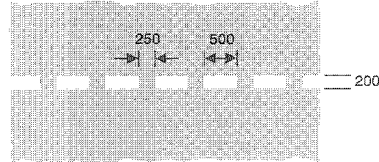

1003.2  
Pedestrians approaching a level crossing should wait behind the line when the barriers are closed or when the light signals as shown in diagram 3014 are showing or if there are neither barriers nor light signals until it is safe to proceed

Item	
1	Regulations: 38
2	Directions: None
3	Diagrams: 3014, 4006
4	Permitted variants: None
5	Illumination requirements: Schedule 17, item 12

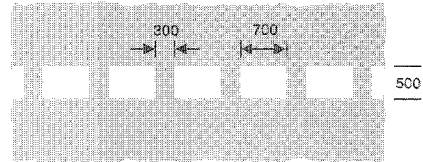

1003.3  
Vehicular traffic approaching a roundabout with small central island or approaching a junction marked by signs as shown in diagram 611.1 should give way at or immediately beyond the line to traffic circulating on the carriageway of the roundabout

Item	
1	Regulations: 26
2	Directions: 15, 16
3	Diagrams: 611.1, 1003.4
4	Permitted variants: None
5	Illumination requirements: Schedule 17, item 12

**Status:** This is the original version (as it was originally made). This item of legislation is currently only available in its original format.

SCHEDULE 6 ROAD MARKINGS (contd.)

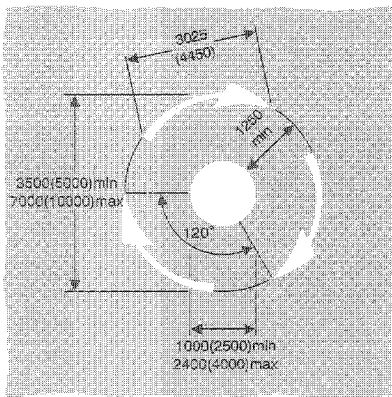

1003.4  
Direction of traffic flow at a junction marked by signs shown in diagram 611.1

Item	
1	Regulations: 28, 29
2	Directions: 15, 16
3	Diagrams: 602, 611.1, 1003, 1003.3, 1023
4	Permitted variants: None
5	Illumination requirements: Schedule 17, item 12

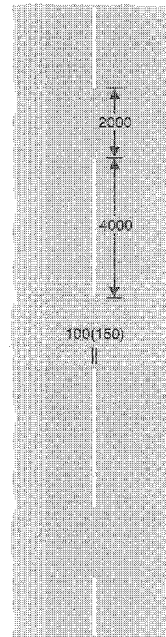

1004  
Vehicular traffic on roads with a speed limit of 40 mph or less should not cross or straddle the line unless it is safe to do so, and when the line is used in conjunction with the sign in diagram 867 motor vehicles should not enter a cycle lane unless that lane is clear of pedal cycles

Item	
1	Regulations: 4, 28
2	Directions: None
3	Diagrams: 867, 1067
4	Permitted variants: None
5	Illumination requirements: Schedule 17, item 12

**Status:** This is the original version (as it was originally made). This item of legislation is currently only available in its original format.

SCHEDULE 6 ROAD MARKINGS (contd.)

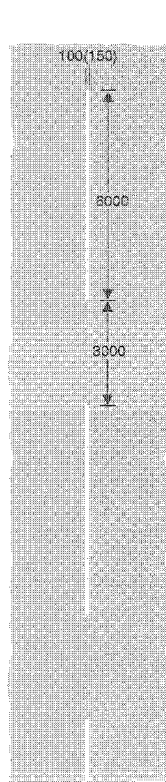

1004.1  
As diagram 1004 on roads with a speed limit of more than 40 mph

Item	
1	Regulations: 4, 28
2	Directions: None
3	Diagrams: 987, 1057
4	Permitted variants: None
5	Illumination requirements: Schedule 17, item 12



1005  
Division of the carriageway into traffic lanes on the part of the carriageway where vehicles normally proceed in the same direction on roads with a speed limit of 40 mph or less other than at places where the marking shown in diagram 1004 is used

Item	
1	Regulations: 4, 28
2	Directions: None
3	Diagrams: None
4	Permitted variants: None
5	Illumination requirements: Schedule 17, item 12

**Status:** This is the original version (as it was originally made). This item of legislation is currently only available in its original format.

SCHEDULE 6 ROAD MARKINGS (contd.)

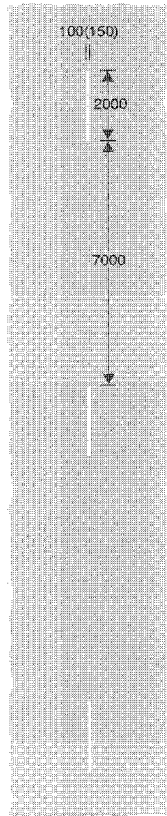

1005.1

As diagram 1005 on roads with a speed limit of more than 40mph other than at places where the marking shown in diagram 1004.1 is used

Item	
1	Regulations: 4, 28
2	Directions: None
3	Diagrams: None
4	Permitted variants: None
5	Illumination requirements: Schedule 17, item 12

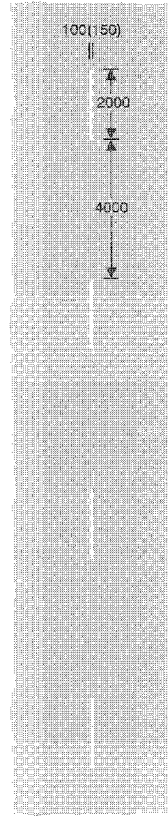

1008

Division between opposing flows of traffic on a carriageway with a speed limit of 40 mph or less other than at places where the marking shown in diagram 1004 is used

Item	
1	Regulations: 4, 28
2	Directions: None
3	Diagrams: None
4	Permitted variants: None
5	Illumination requirements: Schedule 17, item 12

**Status:** This is the original version (as it was originally made). This item of legislation is currently only available in its original format.

SCHEDULE 6 ROAD MARKINGS (contd.)

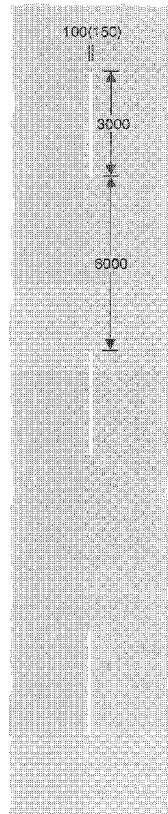

1008.1

Division between opposing flows of traffic on a carriageway with a speed limit of more than 40 mph other than at places where the marking shown in diagram 1004.1 is used

item	
1	Regulations: 4, 26
2	Directions: None
3	Diagrams: None
4	Permitted variants: None
5	Illumination requirements: Schedule 17, item 12

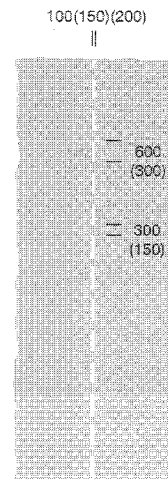

1009

Edge of the carriageway at a road junction, exit from a private drive onto a public road, or where laid diagonally across part of the carriageway, the start of a cycle lane

item	
1	Regulations: 4, 12(3), 26
2	Directions: 16
3	Diagrams: None
4	Permitted variants: None
5	Illumination requirements: Schedule 17, item 12

**Status:** This is the original version (as it was originally made). This item of legislation is currently only available in its original format.

SCHEDULE 6 ROAD MARKINGS (contd.)

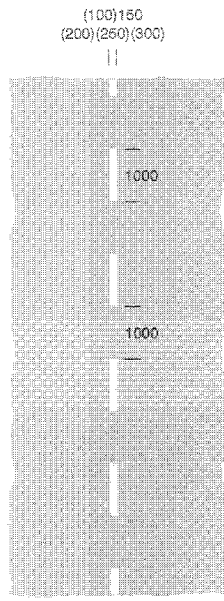

1010

- (a) Edge of the carriageway at a road junction, exit from a private drive onto a public road or a lay-by; or
- (b) where laid diagonally across part of the carriageway, the start of a traffic lane, the boundary of which is indicated by diagram 1049; or
- (c) when used in conjunction with diagram 1014 and 1024.1, the most suitable path for high vehicles through an arch bridge; or
- (d) when laid alongside rails used by trams, the edge of the part of the carriageway used by the trams; or
- (e) the division between the main carriageway and a traffic lane which leaves the main carriageway at a junction ahead

Item	
1	Regulations: 4, 26
2	Directions: 16
3	Diagrams: 1014, 1024.1, 1049
4	Permitted variants: None
5	Illumination requirements: Schedule 17, item 12



1012.1

Edge of the carriageway available for through traffic other than at a road junction, an exit from a private drive onto a public road or a lay-by

Item	
1	Regulations: 28
2	Directions: None
3	Diagrams: None
4	Permitted variants: None
5	Illumination requirements: Schedule 17, item 12

**Status:** This is the original version (as it was originally made). This item of legislation is currently only available in its original format.

SCHEDULE 6 ROAD MARKINGS (contd.)

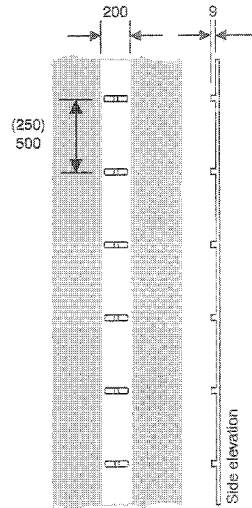

1012.2

Alternative to the marking shown in diagram 1012.1 incorporating an audible and tactile warning in the form of a raised rib for use on motorways

Item	
1	Regulations: 11(2), 26, 29
2	Directions: 13(1)
3	Diagrams: 1040.3, 1040.5, 1042
4	Permitted variants: The notch may be omitted from the raised rib
5	Illumination requirements: Schedule 17, item 12

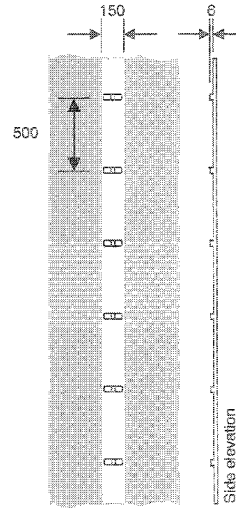

1012.3

As diagram 1012.2 for use on all-purpose roads with hard strips

Item	
1	Regulations: 11(2), 26, 29
2	Directions: 12(3)
3	Diagrams: 1040.3, 1040.5
4	Permitted variants: The notch may be omitted from the raised rib The width of the line shall be increased to 200 millimetres when used on all-purpose roads with hard shoulders
5	Illumination requirements: Schedule 17, item 12

**Status:** This is the original version (as it was originally made). This item of legislation is currently only available in its original format.

SCHEDULE 6 ROAD MARKINGS (contd.)

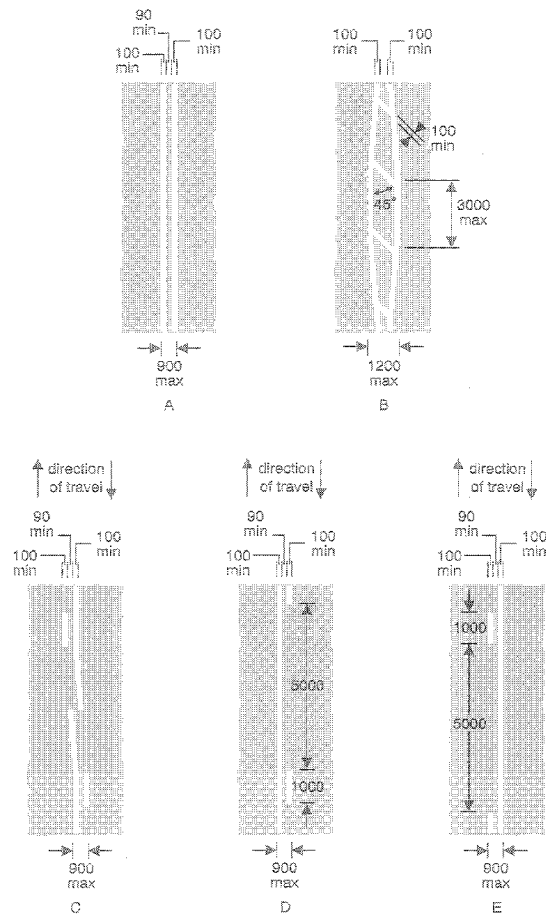

1013.1  
Alternative methods of indicating to vehicular traffic the requirements and the warning prescribed in regulation 26

Item	
1	Regulations: 4, 10(1), 10(2), 26, 28
2	Directions: 43
3	Diagrams: 1014
4	Permitted variants: None
5	Illumination requirements: Schedule 17, item 12



**Status:** This is the original version (as it was originally made). This item of legislation is currently only available in its original format.

SCHEDULE 6 ROAD MARKINGS (contd.)

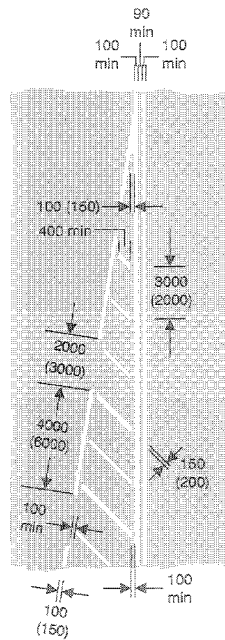

1013.3

As diagram 1013.1, with an adjacent part of the carriageway which vehicular traffic should not enter unless it is seen by the driver to be safe to do so

Item	
1	Regulations: 4, 10(1), 10(2), 12(4), 28, 28
2	Directions: 43
3	Diagrams: 1014
4	Permitted variants: None
5	Illumination requirements: Schedule 17, item 12

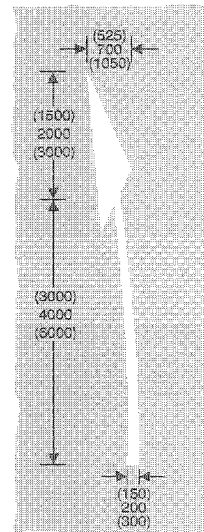

1014

- (a) Direction in which vehicular traffic should pass a road marking shown in diagram 1013.1, 1013.3, 1040, 1040.3, 1045.4 or 1048 ahead; or
- (b) obstruction on the carriageway ahead; or
- (c) when used in conjunction with the marking shown in diagram 1010, the most suitable path for high vehicles through an arch bridge

Item	
1	Regulations: 28
2	Directions: 18, 43
3	Diagrams: 1010, 1013.1, 1013.3, 1024.1, 1040, 1040.3, 1040.4, 1048
4	Permitted variants: The symbol may be reversed in a mirror image
5	Illumination requirements: Schedule 17, item 12

Status: This is the original version (as it was originally made). This item of legislation is currently only available in its original format.

SCHEDULE 6 ROAD MARKINGS (contd.)



1017

Waiting of vehicles on a side of a length of road prohibited for a time less than that specified in the caption to diagram 1018.1

Item	
1	Regulations: None
2	Directions: 7, 20, 22, 23
3	Diagrams: 637.2, 639, 639.1A, 640, 663, 663.1, 664, 1060, 1060.1, 1061, 1061.1
4	Permitted variants: None
5	Illumination requirements: Schedule 17, item 12

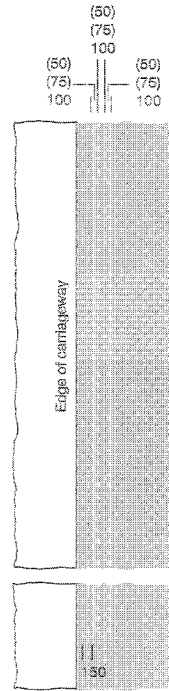

1018.1

Waiting of vehicles on a side of a length of road prohibited at any time during a period of at least 4 consecutive months

Item	
1	Regulations: None
2	Directions: 7, 20, 22, 23
3	Diagrams: 637, 637.2, 637.3, 642.3, 663, 663.1, 664, 1060, 1060.1, 1061, 1061.1
4	Permitted variants: None
5	Illumination requirements: Schedule 17, item 12

**Status:** This is the original version (as it was originally made). This item of legislation is currently only available in its original format.

SCHEDULE 6 ROAD MARKINGS (contd.)

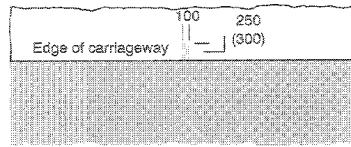

1019  
Loading or unloading of vehicles on a side of a length of road prohibited for a time less than that specified in the caption to diagram 1020.1

Item	
1	Regulations: None
2	Directions: 7, 21, 22, 23
3	Diagrams: 637.2, 638.1, 640, 663, 663.1, 664
4	Permitted variants: None
5	Illumination requirements: Schedule 17, item 12

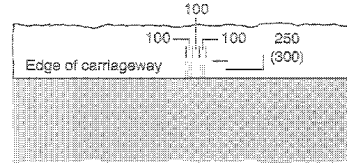

1020.1  
Loading or unloading of vehicles on a side of a length of road prohibited at any time during a period of at least 4 consecutive months

Item	
1	Regulations: None
2	Directions: 7, 21, 22, 23
3	Diagrams: 637.2, 638, 642.3, 663, 663.1, 664
4	Permitted variants: None
5	Illumination requirements: Schedule 17, item 12

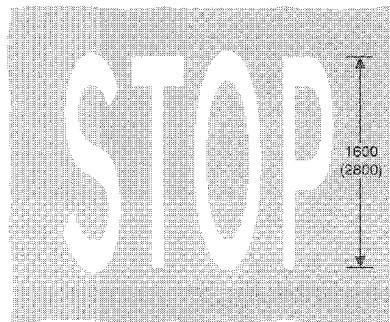

1022  
Approach to a road junction at or near which is placed the sign shown in diagram 601.1 and the road marking shown in diagram 1002.1

Item	
1	Regulations: 28
2	Directions: 15, 16
3	Diagrams: 601.1, 1002.1
4	Permitted variants: None
5	Illumination requirements: Schedule 17, item 12

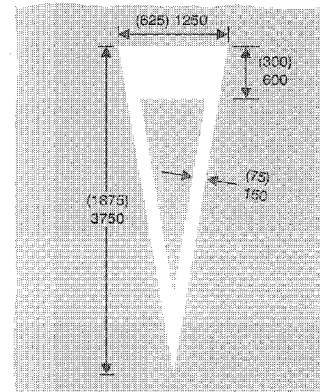

1023  
Approach to a road junction at or near which is placed the marking shown in diagram 1003 or both the marking shown in diagram 1003 and the sign shown in diagram 602

Item	
1	Regulations: 25, 28
2	Directions: 15, 16
3	Diagrams: 602, 611.1, 1003, 1003.4
4	Permitted variants: None
5	Illumination requirements: Schedule 17, item 12

**Status:** This is the original version (as it was originally made). This item of legislation is currently only available in its original format.

SCHEDULE 6 ROAD MARKINGS (contd.)

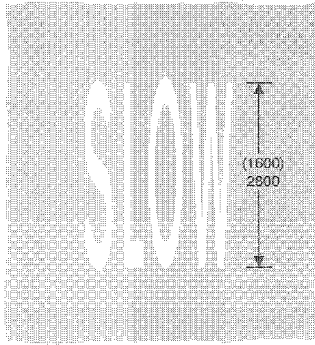

1024  
Vehicular traffic should proceed with caution because of potential danger ahead

Item	
1	Regulations: 28
2	Directions: None
3	Diagrams: None
4	Permitted variants: None
5	Illumination requirements: Schedule 17, item 12

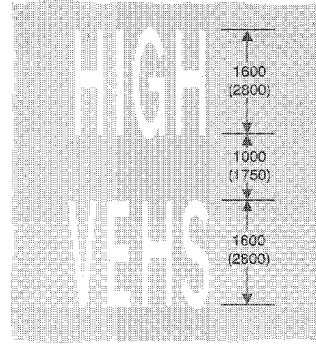

1024.1  
Path to be taken by high vehicles through an arch bridge or the route to avoid a low bridge

Item	
1	Regulations: 28
2	Directions: 18
3	Diagrams: 1010, 1014
4	Permitted variants: None
5	Illumination requirements: Schedule 17, item 12

**Status:** This is the original version (as it was originally made). This item of legislation is currently only available in its original format.

SCHEDULE 6 ROAD MARKINGS (contd.)

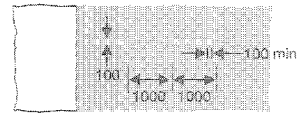
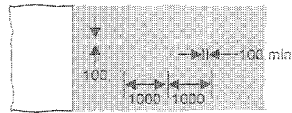
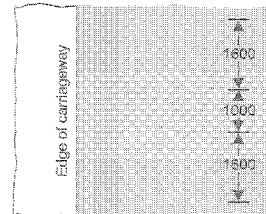
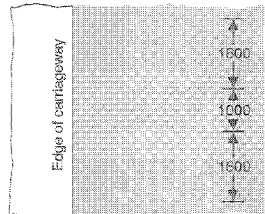
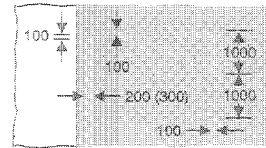
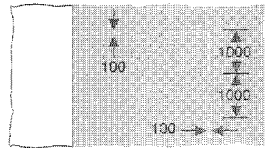

1025  
Stopping place for buses on part of the carriageway also used by through traffic

1025.1  
As diagram 1025 where other vehicles are prohibited from stopping at certain times

Item	
1	Regulations: 22
2	Directions: None
3	Diagrams: 970, 973, 973.1
4	Permitted variants: "STOP" may be varied to "STAND"
5	Illumination requirements: Schedule 17, item 12

Item	
1	Regulations: 22
2	Directions: 7, 20, 22, 23
3	Diagrams: 970, 973, 973.1, 974, 975
4	Permitted variants: Same as diagram 1025
5	Illumination requirements: Schedule 17, item 12

**Status:** This is the original version (as it was originally made). This item of legislation is currently only available in its original format.

SCHEDULE 6 ROAD MARKINGS (contd.)

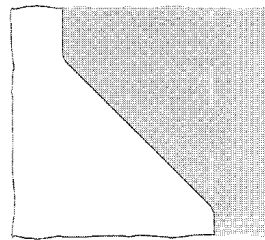
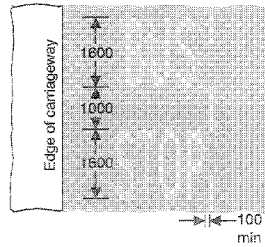
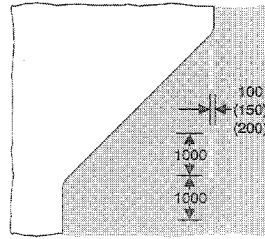

1025.2  
Stopping place for buses in a lay-by

Item	
1	Regulations: 22, 23
2	Directions: None
3	Diagrams: 970, 973, 973.1
4	Permitted variants: Same as diagram 1025 The shape of the marking may be varied
5	Illumination requirements: Schedule 17, item 12

**Status:** This is the original version (as it was originally made). This item of legislation is currently only available in its original format.

SCHEDULE 6 ROAD MARKINGS (contd.)

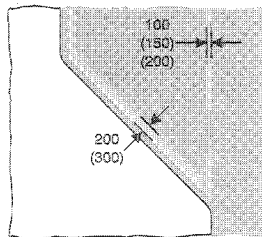
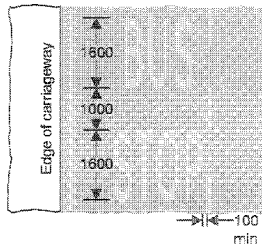
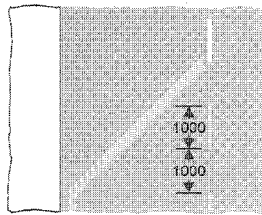
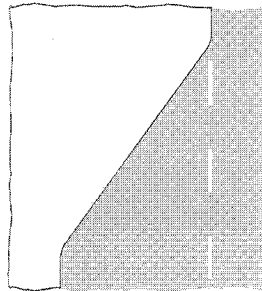

1025.3

As diagram 1025.2 where other vehicles are prohibited from stopping at certain times

Item	
1	Regulations: 22, 28
2	Directions: 7, 20, 22, 23
3	Diagrams: 970, 973, 973.1, 974, 975
4	Permitted variants: Same as diagram 1025.2
5	Illumination requirements: Schedule 17, item 12

**Status:** This is the original version (as it was originally made). This item of legislation is currently only available in its original format.

SCHEDULE 6 ROAD MARKINGS (contd.)

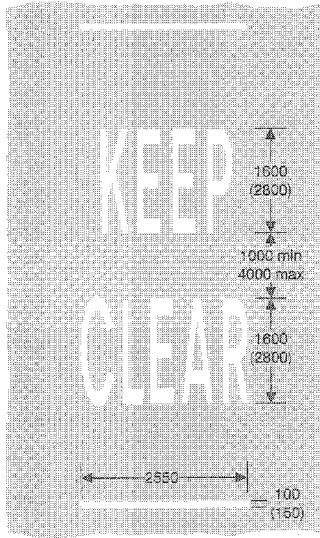

1026  
Part of the carriageway which should be kept clear of stationary vehicles

Item	
1	Regulations: None
2	Directions: None
3	Diagrams: None
4	Permitted variants: The white line indicating the extent of the area to be kept clear may be omitted
5	Illumination requirements: Schedule 17, item 12

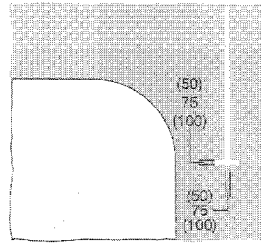
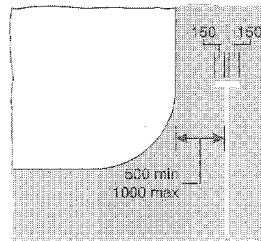

1026.1  
Part of the carriageway outside an entrance to off-street premises, or where the kerb is dropped to provide a convenient crossing place for pedestrians, which should be kept clear of stationary vehicles

Item	
1	Regulations: None
2	Directions: None
3	Diagrams: None
4	Permitted variants: None
5	Illumination requirements: Schedule 17, item 12



**Status:** This is the original version (as it was originally made). This item of legislation is currently only available in its original format.

SCHEDULE 6 ROAD MARKINGS (contd.)

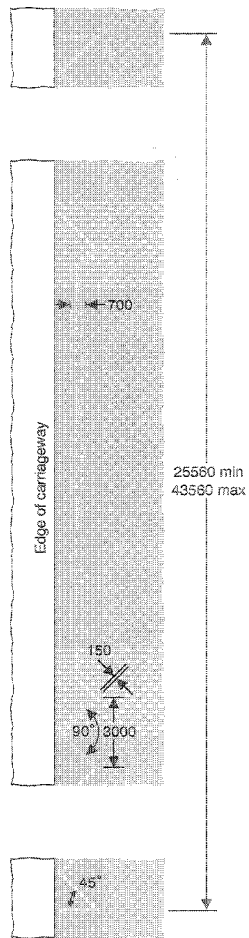

1027.1

Part of the carriageway outside a school entrance which should be kept clear of stationary vehicles

Item	
1	Regulations: None
2	Directions: 20, 22
3	Diagrams: 642.2
4	Permitted variants: The word "SCHOOL" shall be omitted and the minimum length of the marking reduced to 25260 millimetres when used outside a fire, police or ambulance station
5	Illumination requirements: Schedule 17, item 12

**Status:** This is the original version (as it was originally made). This item of legislation is currently only available in its original format.

SCHEDULE 6 ROAD MARKINGS (contd.)

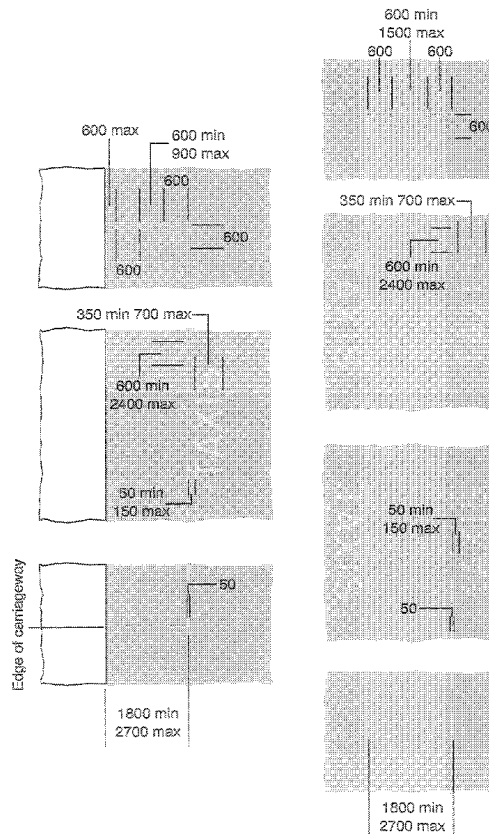

1028.2

Alternative types of taxi rank either at the edge or in the centre of the carriageway

Item	
1	Regulations: 22(1)
2	Directions: 7, 22, 23
3	Diagrams: 850.1, 650.2, 857.1, 969
4	Permitted variants: The number of times the word "TAXIS" is shown may be varied according to the length of the marking. "TAXIS" may be varied to: 1. "BUSES" 2. "COACHES" 3. "POLICE" 4. "AMBULANCES"
5	Illumination requirements: Schedule 17, item 12

**Status:** This is the original version (as it was originally made). This item of legislation is currently only available in its original format.

SCHEDULE 6 ROAD MARKINGS (contd.)

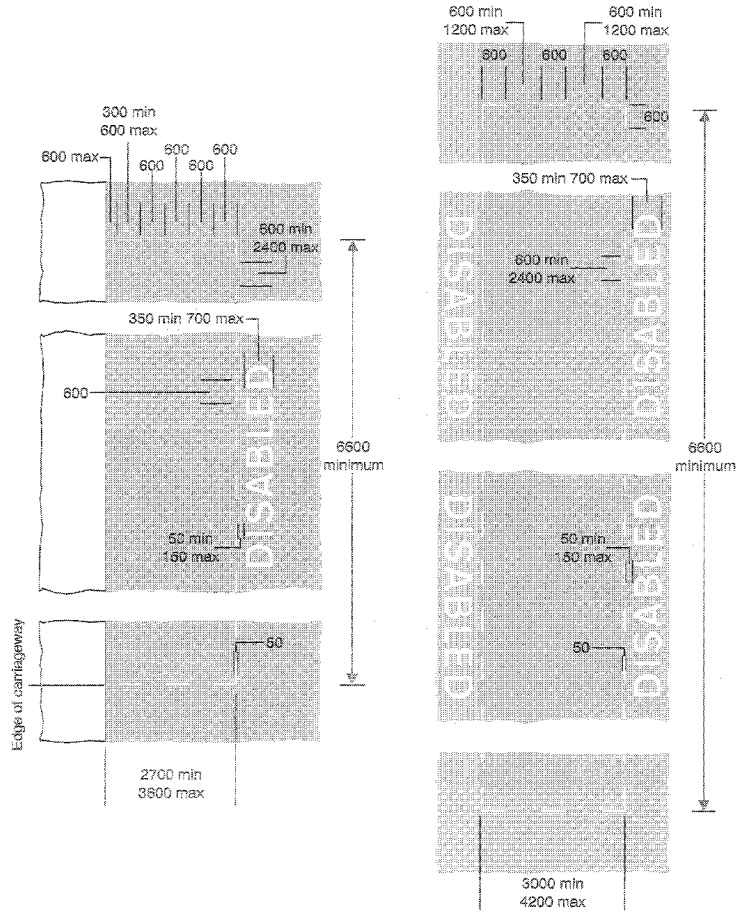

1028.3

Alternative types of parking bays reserved for disabled badge holders either at the edge or in the centre of the carriageway

Item	
1	Regulations: None
2	Directions: 7, 22, 23
3	Diagrams: 660, 660.4, 661
4	Permitted variants: The number of times the word "DISABLED" is shown may be varied according to the length of the marking "DISABLED" may be omitted or varied to: 1. "LARGE OR SLOW VEHICLES ONLY" 2. "LOADING ONLY"
5	Illumination requirements: Schedule 17, item 12

**Status:** This is the original version (as it was originally made). This item of legislation is currently only available in its original format.

SCHEDULE 6 ROAD MARKINGS (contd.)

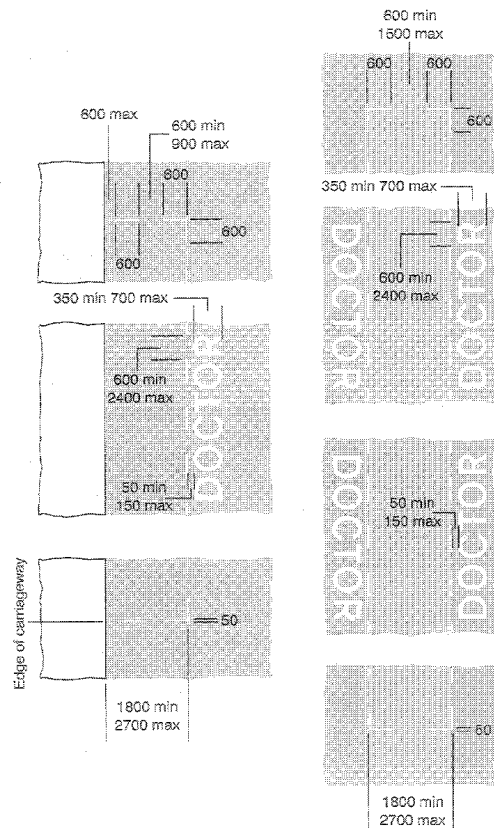

1026.4

Alternative types of parking bays reserved for doctor permit holders either at the edge or in the centre of the carriageway

Item	
1	Regulations: None
2	Directions: 7, 22, 23
3	Diagrams: 639.1A, 660, 660.S, 660.S, 661.1, 661.2, 661.3, 662, 661
4	Permitted variants: The number of times the word "DOCTOR" is shown may be varied according to the length of the marking. "DOCTOR" may be omitted or varied to: 1. "MOTORCYCLES ONLY" 2. "M/C'S ONLY" 3. "SOLO MOTORCYCLES ONLY" 4. "SOLO M/C'S ONLY"
5	Illumination requirements: Schedule 17, Item 12

**Status:** This is the original version (as it was originally made). This item of legislation is currently only available in its original format.

SCHEDULE 6 ROAD MARKINGS (contd.)

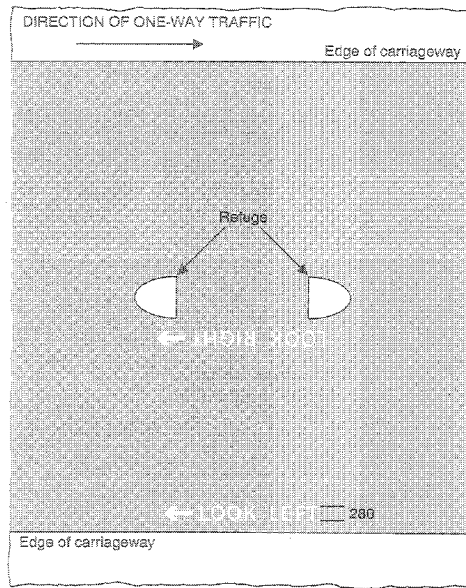

1029  
Direction in which pedestrians should look for approaching traffic

Item	
1	Regulations: None
2	Directions: None
3	Diagrams: None
4	Permitted variants: None
5	Illumination requirements: Schedule 17, item 12

**Status:** This is the original version (as it was originally made). This item of legislation is currently only available in its original format.

SCHEDULE 6 ROAD MARKINGS (contd.)

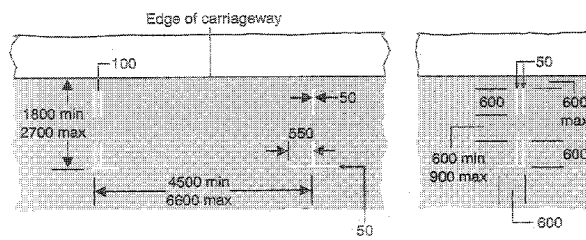

1032

Designated parking place  
(Longitudinal marking)

Item	
1	Regulations: None
2	Directions: 7, 22
3	Diagrams: 680.5, 661.2, 661.3, 662
4	Permitted variants: The number of individual parking spaces may be extended as necessary. The double transverse lines are only to be used at the end of a block of parking places.
5	Illumination requirements: Schedule 17, Item 12

**Status:** This is the original version (as it was originally made). This item of legislation is currently only available in its original format.

SCHEDULE 6 ROAD MARKINGS (contd.)

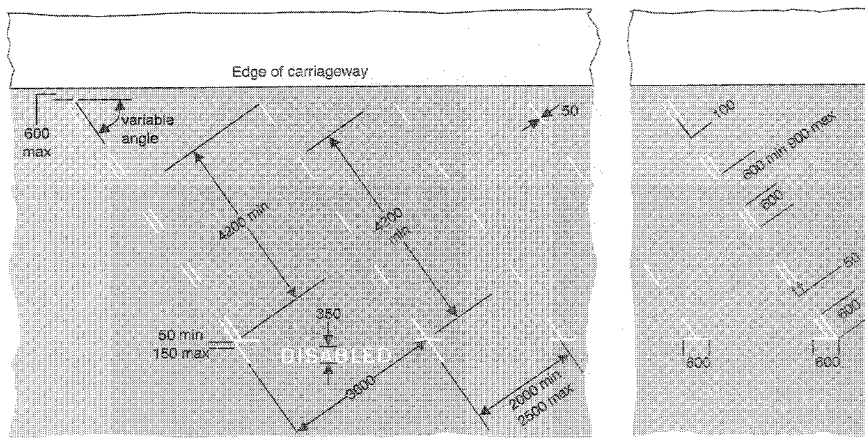

1033

Echelon parking spaces subject to such conditions, if any, as may be in force

Item	
1	Regulations: None
2	Directions: 7, 22, 23
3	Diagrams: 639.1A, 660, 660.3, 660.4, 660.5, 661, 661.1, 661.2, 661.3, 662, 801
4	Permitted variants: "DISABLED" and the associated bay may be omitted Additional "DISABLED" bays may be provided
5	Illumination requirements: Schedule 17, Item 12

**Status:** This is the original version (as it was originally made). This item of legislation is currently only available in its original format.

SCHEDULE 6 ROAD MARKINGS (contd.)

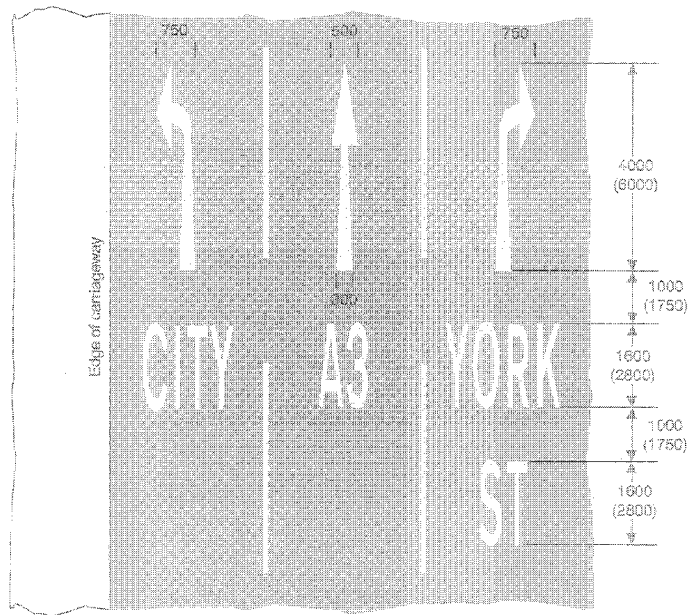

1035

Appropriate traffic lanes for different destinations

Item	
1	Regulations: 12(4), 27, 28
2	Directions: None
3	Diagram: None
4	Permitted variants: Schedule 16, item 19 Arrows may be omitted
5	Illumination requirements: Schedule 17, item 12



**Status:** This is the original version (as it was originally made). This item of legislation is currently only available in its original format.

SCHEDULE 6 ROAD MARKINGS (contd.)

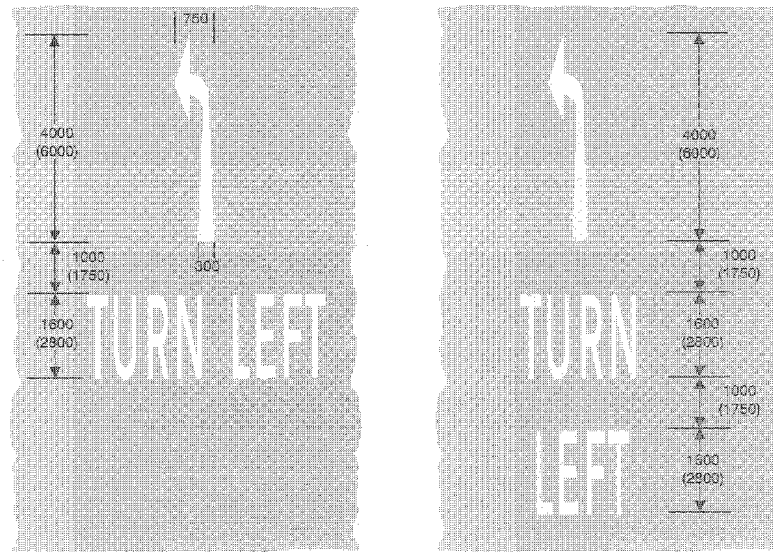

1036.1  
Vehicular traffic must turn left  
(Alternative types)

Item	
1	Regulations: 12(4), 23
2	Directions: 7
3	Diagrams: None
4	Permitted variants: None
5	Illumination requirements: Schedule 17, item 12

**Status:** This is the original version (as it was originally made). This item of legislation is currently only available in its original format.

SCHEDULE 6 ROAD MARKINGS (contd.)

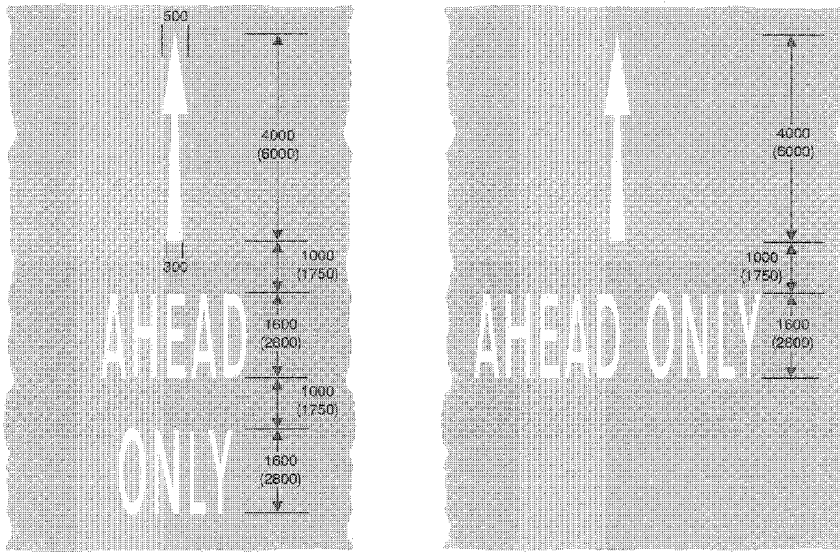

1038.2  
Vehicular traffic must only proceed ahead  
(Alternative types)

Item	
1	Regulations: 12(4), 23
2	Directions: 7
3	Diagrams: None
4	Permitted variants: None
5	Illumination requirements: Schedule 17, item 12

**Status:** This is the original version (as it was originally made). This item of legislation is currently only available in its original format.

SCHEDULE 6 ROAD MARKINGS (contd.)

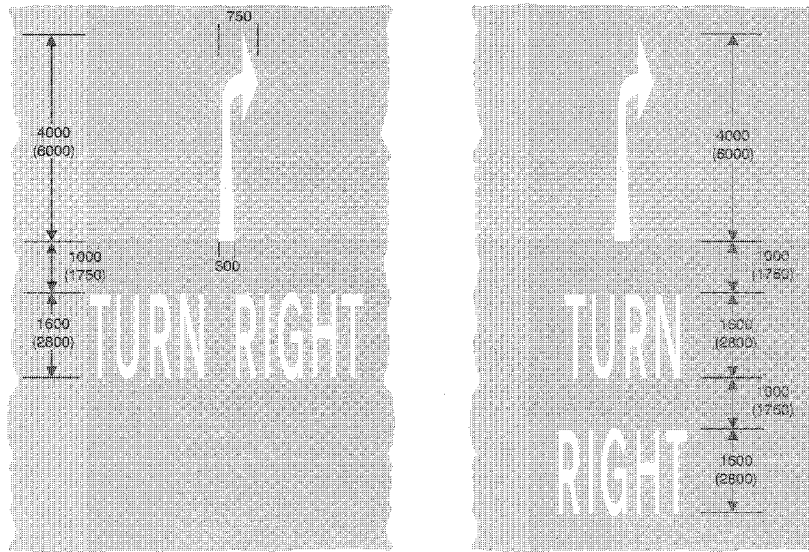

1037.1  
Vehicular traffic must turn right  
(Alternative types)

Item	
1	Regulations: 12(4), 28
2	Directions: 7
3	Diagrams: None
4	Permitted variants: None
5	Illumination requirements: Schedule 17, item 12

**Status:** This is the original version (as it was originally made). This item of legislation is currently only available in its original format.

SCHEDULE 6 ROAD MARKINGS (contd.)

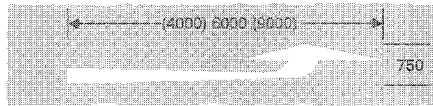

1038

Appropriate traffic lanes for different manoeuvres  
(Longitudinal marking)

Item	
1	Regulations: None
2	Directions: None
3	Diagrams: None
4	Permitted variants: Direction of the arrow heads may be varied, but no arrow shall show more than two directions
5	Illumination requirements: Schedule 17, item 12



1039

Place where traffic streams divide or bifurcate  
(Longitudinal marking)

Item	
1	Regulations: 28
2	Directions: None
3	Diagrams: None
4	Permitted variants: Schedule 16, item 28
5	Illumination requirements: Schedule 17, item 12

164

**Status:** This is the original version (as it was originally made). This item of legislation is currently only available in its original format.

SCHEDULE 6 ROAD MARKINGS (contd.)

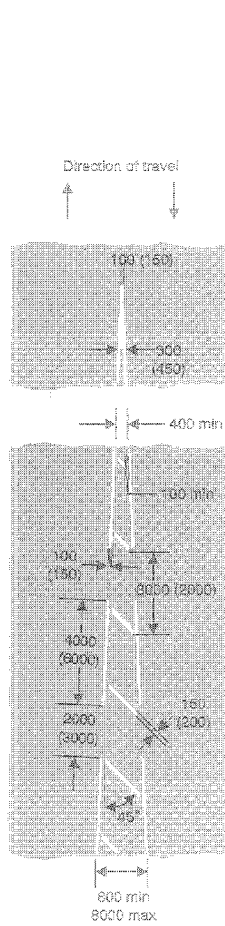

1040

Part of the carriageway which vehicular traffic should not enter unless it is seen by the driver to be safe to do so

Item	
1	Regulations: 4, 12(4), 23
2	Directions: 8
3	Diagrams: None
4	Permitted variants: The boundary line may be varied to a continuous white line when the marking is on a part of the carriageway which traffic should not enter except in an emergency
5	Illumination requirements: Schedule 17, Item 12

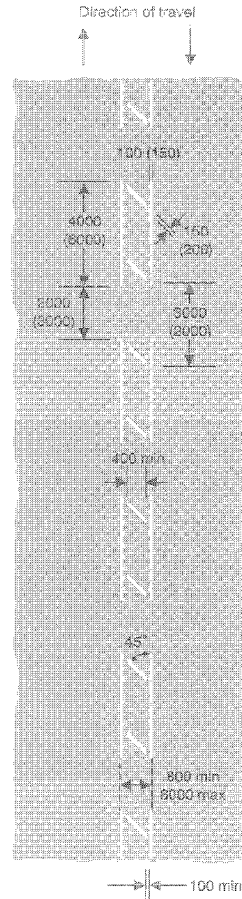

1040.2

Length of road along which drivers should not overtake by passing through the marking unless it is seen by the driver to be safe to do so

Item	
1	Regulations: 4, 12(4), 23
2	Directions: 8
3	Diagrams: None
4	Permitted variants: Same as diagram 1040
5	Illumination requirements: Schedule 17, Item 12

**Status:** This is the original version (as it was originally made). This item of legislation is currently only available in its original format.

SCHEDULE 6 ROAD MARKINGS (contd.)

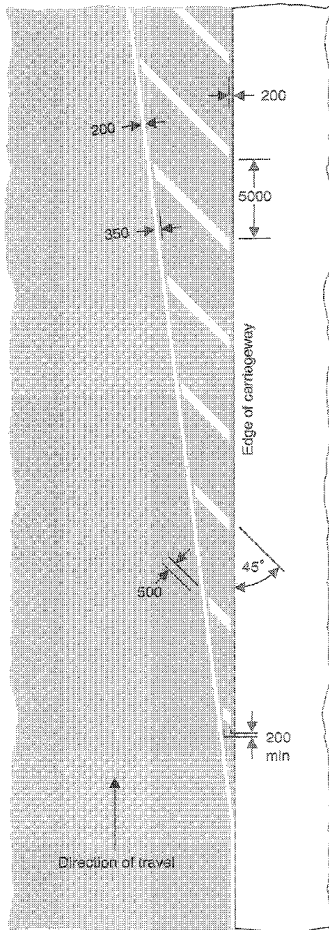

1040.3  
Reduction in number of lanes on a motorway or all-purpose dual carriageway

Item	
1	Regulations: 28
2	Directions: None
3	Diagrams: 1012.2, 1012.3, 1014
4	Permitted variants: The width of the longitudinal line may be varied to 150 millimetres when used on an all-purpose road
5	Illumination requirements: Schedule 17, item 12

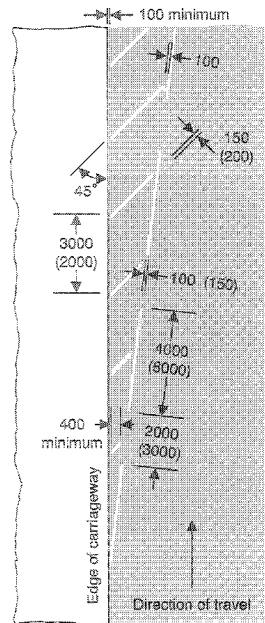

1040.4  
Part of the carriageway adjacent to the edge which vehicular traffic should not enter unless it is seen by the driver to be safe to do so

Item	
1	Regulations: 12(4), 28
2	Directions: None
3	Diagrams: 1014
4	Permitted variants: The angle of the hatching shall be reversed when the marking is used on the off-side of the carriageway
5	Illumination requirements: Schedule 17, item 12

**Status:** This is the original version (as it was originally made). This item of legislation is currently only available in its original format.

SCHEDULE 6 ROAD MARKINGS (contd.)

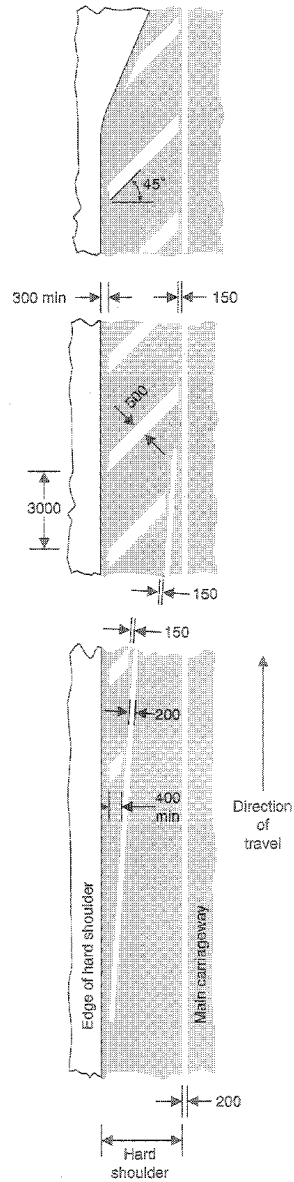

1040.5  
End of hard shoulder

Item	
1	Regulations: 28
2	Directions: None
3	Diagrams: 1012.2, 1012.3
4	Permitted variants: None
5	Illumination requirements: Schedule 17, item 12

Status: This is the original version (as it was originally made). This item of legislation is currently only available in its original format.

SCHEDULE 9 ROAD MARKINGS (contd.)

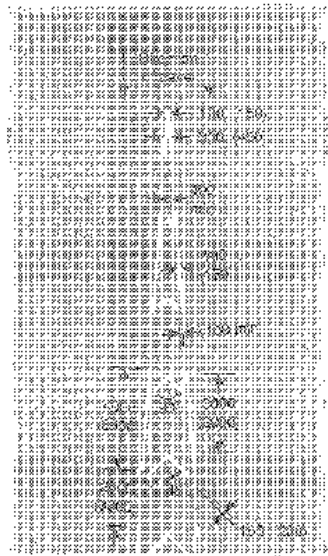

1041  
Part of the carriageway where vehicular traffic passes in the same direction on both sides of the marking, and should not enter the area covered by the marking unless it is used by the driver as a safe to do so

1	Regulations, 10(4), 24
2	Dimensions: None
3	Regulation: None
4	Particular materials: The application of the chevron shall be extended when the direction of travel is in the opposite direction
5	Regulation requirements: Schedule 10, item 12

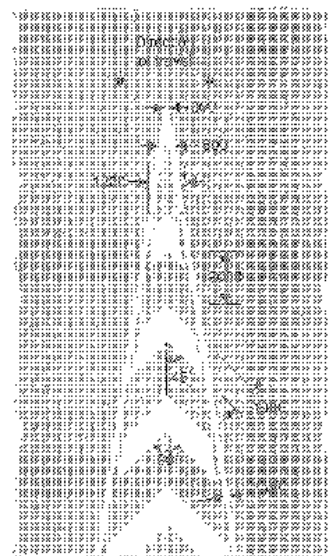

1042  
Part of the verge or the shoulder of a roadway between the main roadway, as defined, and the carriageway or a side road, or a line situated at the junction of roadways with a continuous main road and used except in an emergency

1	Regulations, 20
2	Dimensions: 1000
3	Distances: 1000
4	Particular materials: Same as diagram 1041
5	Regulation requirements: Schedule 10, item 12



**Status:** This is the original version (as it was originally made). This item of legislation is currently only available in its original format.

SCHEDULE 6 ROAD MARKINGS (contd.)

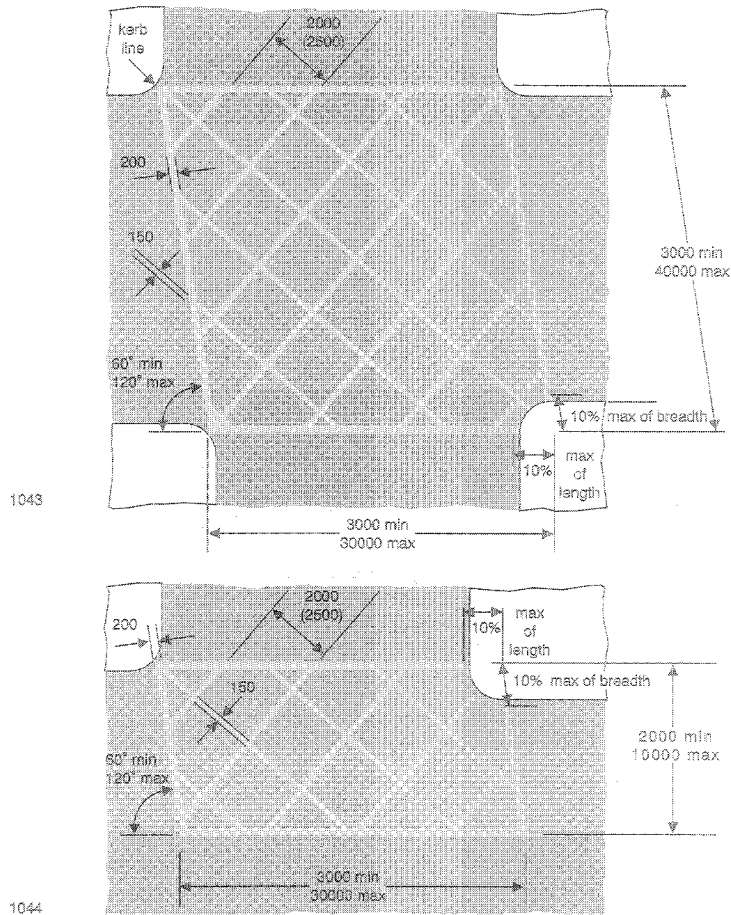

Area of carriageway at a junction, other than a roundabout, which vehicles must not enter in a manner which then causes any part of the vehicle to remain stationary within that area due to the presence of stationary vehicles, except that vehicles waiting to complete a right turn may remain stationary within the area for so long as prevented from completing that turn by reason either of oncoming vehicles or of the presence of other stationary vehicles waiting in or near that area to complete a right turn. When the markings are used with the signs shown in diagrams 615 and 611 on an area of carriageway, the width of which is less than 4,5 metres at any point, vehicles must not enter the marked area in a manner which then causes any part of the vehicle to remain stationary within that area due to the presence of oncoming vehicles or other stationary vehicles beyond the area.  
(Alternative types)

Item	
1	Regulations: 10(1), 12(11)
2	Directions: None
3	Diagrams: 615, 611
4	Permitted variants: Any corner may be cut away as shown. The cut-away corner may be completed in the same manner as the other corners. Parts of the marking may be omitted where tram tracks cross the marking or to indicate the edge of the path taken by a tramcar.
6	Illumination requirements: Schedule 17, item 12

**Status:** This is the original version (as it was originally made). This item of legislation is currently only available in its original format.

SCHEDULE 6 ROAD MARKINGS (contd.)

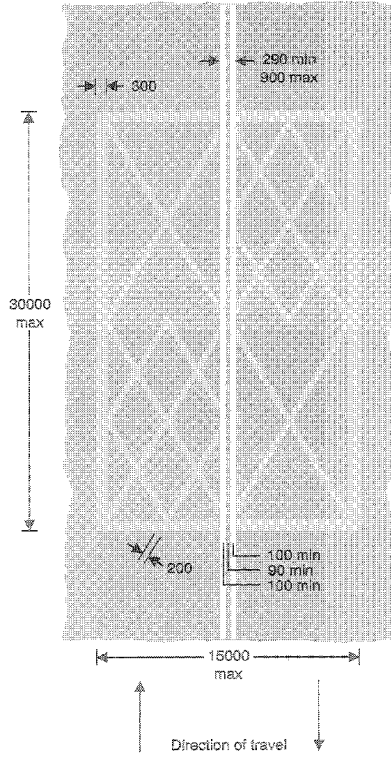

1045

Area of carriageway at a level crossing which vehicles must not enter in a manner which then causes any part of the vehicle to remain at rest within the marked area due to the presence of stationary vehicles

Item	
1	Regulations: 10(1)
2	Directions: None
3	Diagrams: None
4	Permitted variants: None
5	Illumination requirements: Schedule 17, item 12

**Status:** This is the original version (as it was originally made). This item of legislation is currently only available in its original format.

SCHEDULE 6 ROAD MARKINGS (contd.)

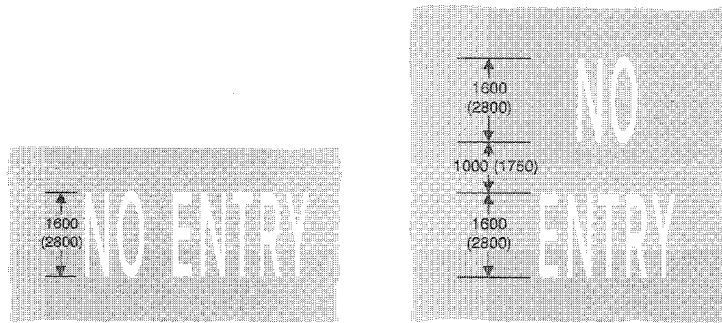

1046  
"No entry" for vehicular traffic  
(Alternative types)

Item	
1	Regulations: 28
2	Directions: 7
3	Diagrams: 616, 617 with 618
4	Permitted variants: "NO ENTRY" may be varied to "PLAY STREET"
5	Illumination requirements: Schedule 17, Item 12

**Status:** This is the original version (as it was originally made). This item of legislation is currently only available in its original format.

SCHEDULE 6 ROAD MARKINGS (contd.)

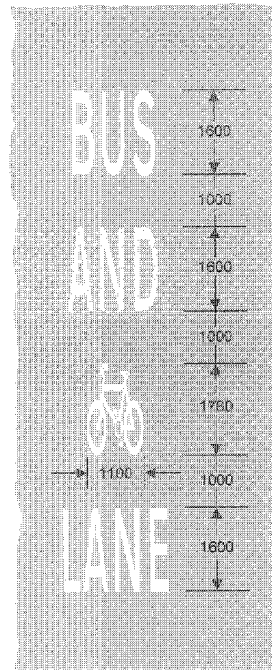
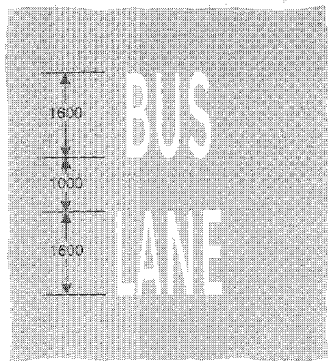

1048

With-flow lane reserved for buses and other vehicles as indicated on the sign shown in diagram 959 or a contra-flow lane reserved for buses

Item	
1	Regulations: 23
2	Directions: 7, 15, 16
3	Diagrams: 959, 980, 1049
4	Permitted variants: None
5	Illumination requirements: Schedule 17, item 12

1048.1

Contra-flow lane reserved for buses and pedal cycles

Item	
1	Regulations: 23
2	Directions: 7, 15, 16
3	Diagrams: 960 when varied to include the cycle symbol, 1049
4	Permitted variants: None
5	Illumination requirements: Schedule 17, item 12

**Status:** This is the original version (as it was originally made). This item of legislation is currently only available in its original format.

SCHEDULE 6 ROAD MARKINGS (contd.)

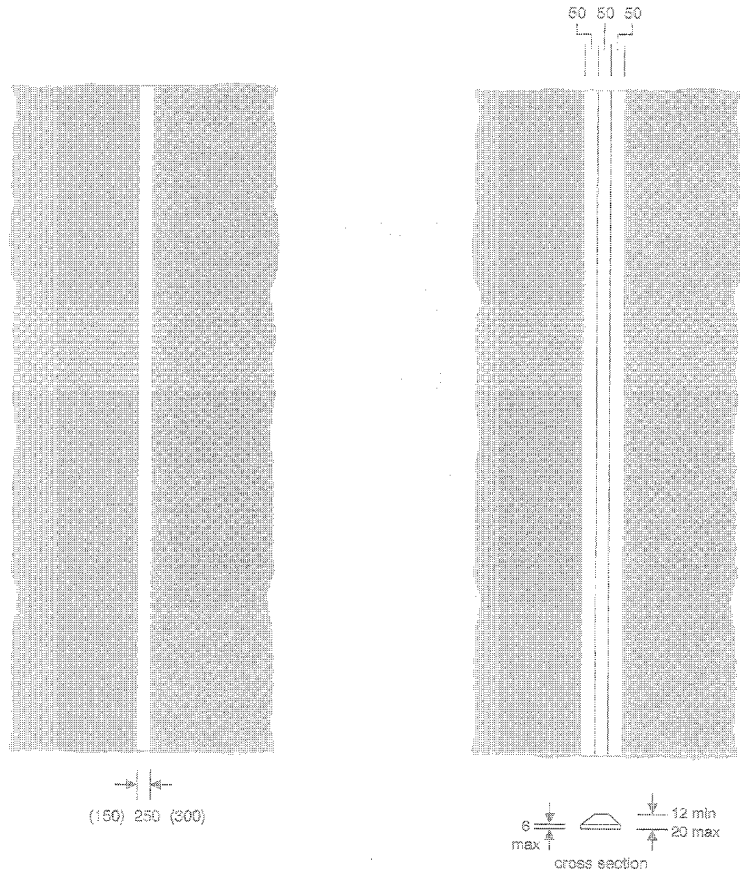

1049  
Boundary of a bus lane or a cycle lane. Where varied to 150mm wide and used in conjunction with the sign to diagram 957, the division of a route into that part reserved for pedal cycles and that part reserved for pedestrians

Item	
1	Regulations: 4, 28
2	Directions: 7, 15, 16, 30
3	Diagrams: 957, 959, 959.1, 960, 960.1, 1010, 1014, 1048, 1048.1, 1050, 1057, 1058
4	Permitted variants: None
5	Illumination requirements: Schedule 17, Item 12

1048.1  
Division of a route into that part reserved for pedal cycles and that part reserved for pedestrians

Item	
1	Regulations: 11(2), 29(2)
2	Directions: 7, 15, 30
3	Diagrams: 957, 1057, 1058
4	Permitted variants: None
5	Illumination requirements: Schedule 17, Item 12

**Status:** This is the original version (as it was originally made). This item of legislation is currently only available in its original format.

SCHEDULE 6 ROAD MARKINGS (contd.)

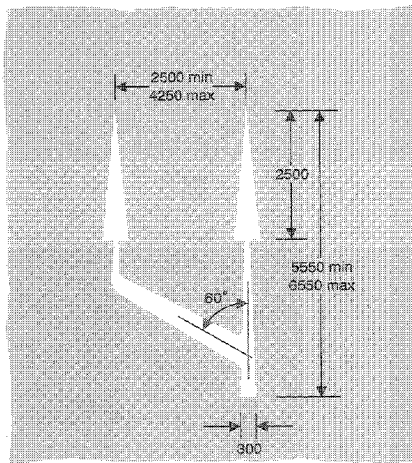

1050  
Direction of possible traffic movements at the end of a bus lane

Item	
1	Regulations: None
2	Directions: 7, 16
3	Diagrams: 964, 1049
4	Permitted variants: The left hand arrow head may indicate a left turn in the manner shown in diagram 1036.1
5	Illumination requirements: Schedule 17, Item 12

**Status:** This is the original version (as it was originally made). This item of legislation is currently only available in its original format.

SCHEDULE 6 ROAD MARKINGS (contd.)

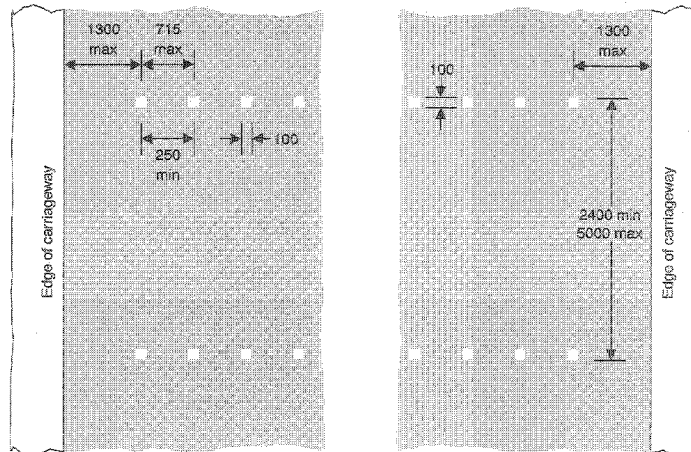

1055

Pedestrian crossing at which traffic is subject to control by a police constable in uniform or a traffic warden, being control which is normally in operation during periods amounting in the aggregate to not less than 20 hours in any week, or the most suitable place for pedestrians to cross a carriageway within 10 metres of light signals as shown in diagram 3000, or in that diagram as varied by regulation 31, or in that diagram in conjunction with the signals shown in diagram 4002

Item	
1	Regulations: 11(4)
2	Directions: None
3	Diagrams: 3000, 3000.2, 3000.3, 3000.4, 3000.5, 3000.6, 4002
4	Permitted variants: The square marks may be varied to circular ones with a diameter of 100mm. The number of marks shall be varied according to the width of the road.
5	Illumination requirements: Schedule 17, item 12

175

**Status:** This is the original version (as it was originally made). This item of legislation is currently only available in its original format.

SCHEDULE 6 ROAD MARKINGS (contd.)

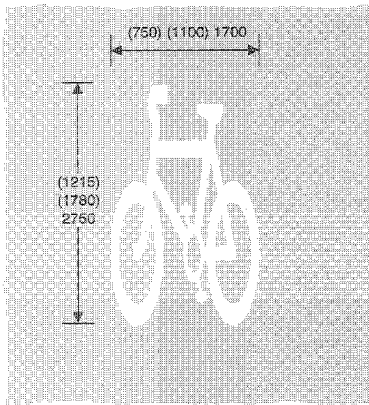

1057  
Cycle lane, track or route

Item	
1	Regulations: None
2	Directions: 15, 16
3	Diagrams: 955, 956, 957, 959.1, 960.1, 965, 967, 1004, 1004.1, 1049, 1049.1, 1052, 1059
4	Permitted variants: Schedule 16, item 28
5	Illumination requirements: Schedule 17, item 12

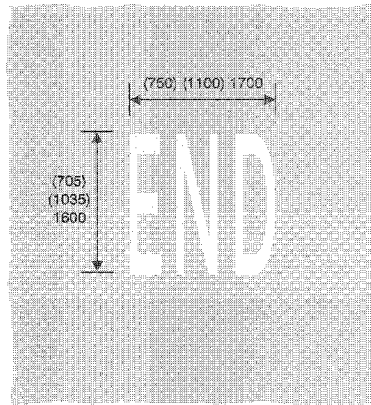

1058  
End of a cycle lane, track or route

Item	
1	Regulations: None
2	Directions: 16
3	Diagrams: 968, 1049, 1049.1, 1057
4	Permitted variants: None
5	Illumination requirements: Schedule 17, item 12



**Status:** This is the original version (as it was originally made). This item of legislation is currently only available in its original format.

SCHEDULE 6 ROAD MARKINGS (contd.)

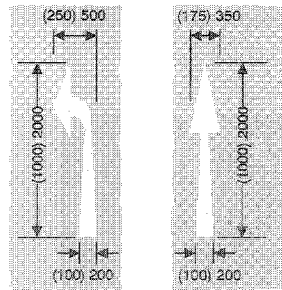

1059  
Directions in which pedal cycles should travel on a cycle lane, track or route

Item	
1	Regulations: None
2	Directions: 16
3	Diagrams: 1057
4	Permitted variants: The arrow pointing to the left may be reversed to point to the right
5	Illumination requirements: Schedule 17, item 12

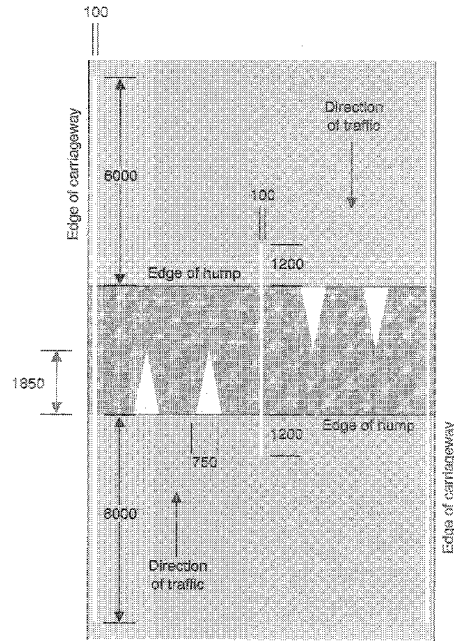

1060  
Road hump with a round top extending across the whole width of the carriageway

Item	
1	Regulations: 26
2	Directions: 15, 18
3	Diagrams: 537.1, 1017, 1018.1
4	Permitted variants: The longitudinal line adjacent to the edge of the carriageway may be omitted when diagram 1017 or 1018.1 is used. Where more than one traffic lane is available to traffic proceeding in the same direction the longitudinal white line shall be placed between each traffic lane and the two triangular white markings shall be placed on each traffic lane. Where traffic is permitted to proceed in one direction only across the road hump, the triangular white markings shall only be placed on the side of the road hump facing traffic approaching the road hump.
5	Illumination requirements: Schedule 17, item 12

**Status:** This is the original version (as it was originally made). This item of legislation is currently only available in its original format.

SCHEDULE 6 ROAD MARKINGS (contd.)

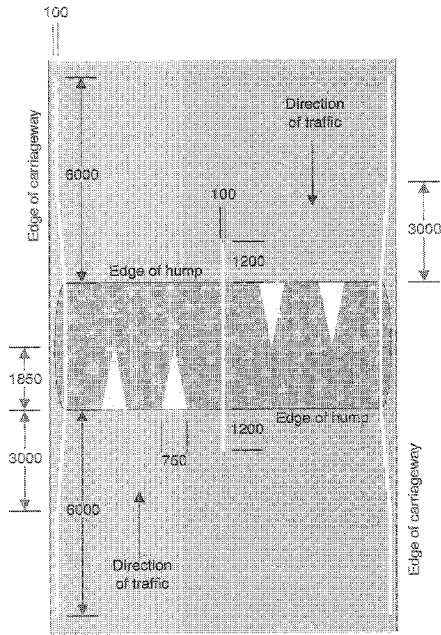

1060.1  
Road hump with a round top and tapered ends

Item	
1	Regulations: 28
2	Directions: 15, 16
3	Diagrams: 567.1, 1017, 1018.1
4	Permitted variants: Same as diagram 1060
5	Illumination requirements: Schedule 17, item 12

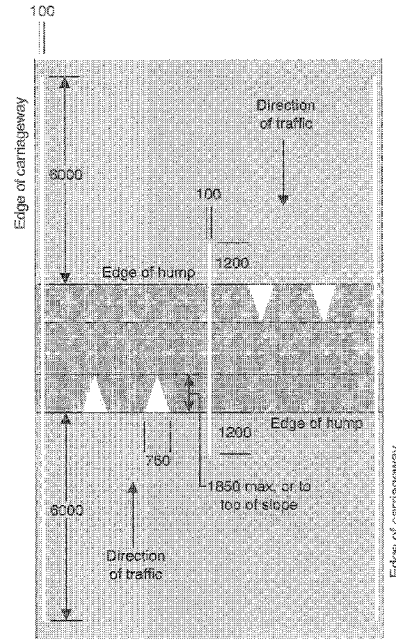

1061  
Road hump with a flat top extending across the whole width of a carriageway

Item	
1	Regulations: 28
2	Directions: 15, 16
3	Diagrams: 567.1, 1017, 1018.1
4	Permitted variants: Same as diagram 1060
5	Illumination requirements: Schedule 17, item 12

**Status:** This is the original version (as it was originally made). This item of legislation is currently only available in its original format.

SCHEDULE 6 ROAD MARKINGS (contd.)

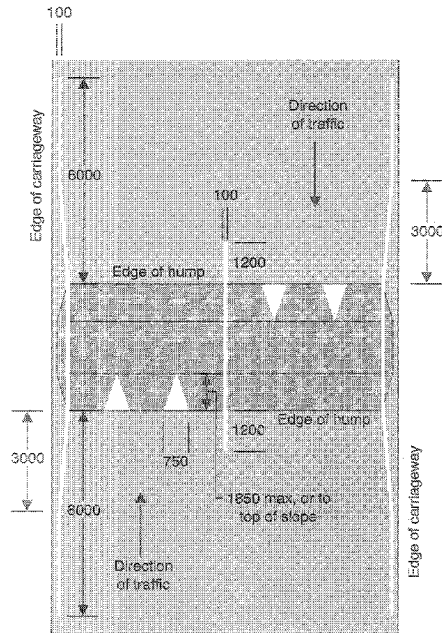

1061.1  
Road hump with a flat top and tapered ends

Item	
1	Regulations: 26
2	Directions: 15, 16
3	Diagrams: 557.1, 1017, 1016.1
4	Permitted variants: Same as diagram 1060
5	Illumination requirements: Schedule 17, Item 12

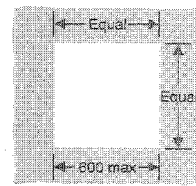
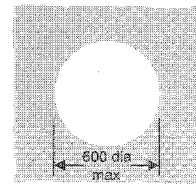

1063  
Limits of a measured length of road for assessing the speed of vehicular traffic by a police constable (Alternative types)

Item	
1	Regulations: None
2	Directions: 34(2)
3	Diagrams: None
4	Permitted variants: None
5	Illumination requirements: Schedule 17, Item 12

**Status:** This is the original version (as it was originally made). This item of legislation is currently only available in its original format.

## SCHEDULE 7

Regulation 11(1)

**Status:** This is the original version (as it was originally made). This item of legislation is currently only available in its original format.

## PART I

### PRIMARY ROUTE DIRECTIONAL SIGNS

#### SCHEDULE 7 PART I PRIMARY ROUTE DIRECTIONAL SIGNS

Regulation 11(1)

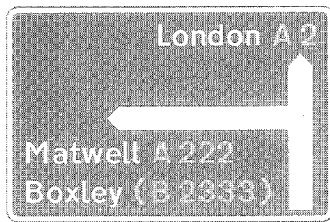

75 min  
300 max

Item	
1	Regulations: None
2	Directions: 11(1)
3	Diagrams: None
4	Permitted variants: Schedule 16, items 3, 5, 16, 18, 19, 20, 21, 23, 24, 25, 26, 27, 30, 31, 32, 34, 35, 36
5	Illumination requirements: Schedule 17, item 4

2001  
Junction ahead of two primary routes

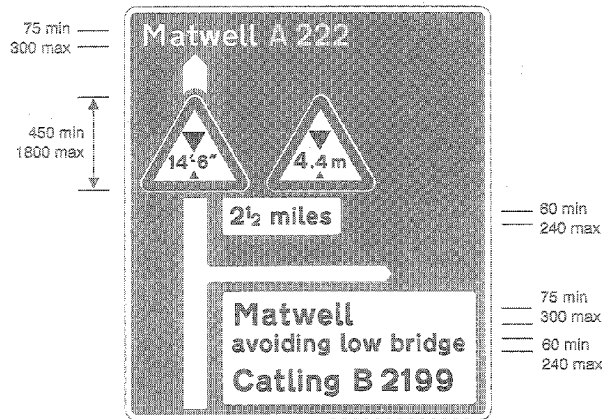

75 min  
300 max

450 min  
1800 max

80 min  
240 max

75 min  
300 max  
80 min  
240 max

2002  
Junction ahead of a primary route with a non-primary route which is the recommended alternative route avoiding a low bridge on the primary route

Item	
1	Regulations: None
2	Directions: 11(1)
3	Diagrams: None
4	Permitted variants: Schedule 16, items 3, 5, 16, 18, 19, 20, 21, 23, 24, 25, 26, 27, 30, 31, 32, 34, 35, 36
5	Illumination requirements: Schedule 17, item 4

**Status:** This is the original version (as it was originally made). This item of legislation is currently only available in its original format.

SCHEDULE 7 PART I PRIMARY ROUTE DIRECTIONAL SIGNS (contd.)

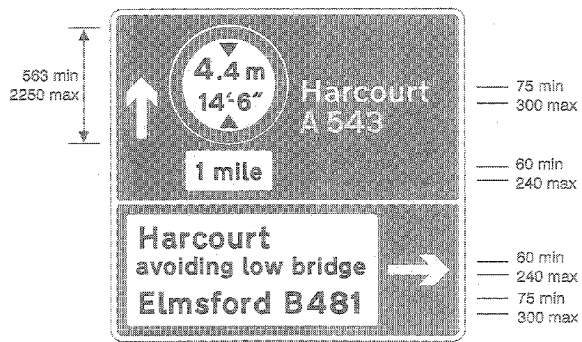

2003  
Same as diagram 2002

Item	
1	Regulations: None
2	Directions: 7, 11(1)
3	Diagrams: None
4	Permitted variants: Schedule 16, items 3, 5, 12, 16, 19, 20, 21, 23, 24, 25, 26, 27, 29, 30, 31, 32, 34, 35, 36
5	Illumination requirements: Schedule 17, item 4

**Status:** This is the original version (as it was originally made). This item of legislation is currently only available in its original format.

SCHEDULE 7 PART 1 PRIMARY ROUTE DIRECTIONAL SIGNS (contd.)

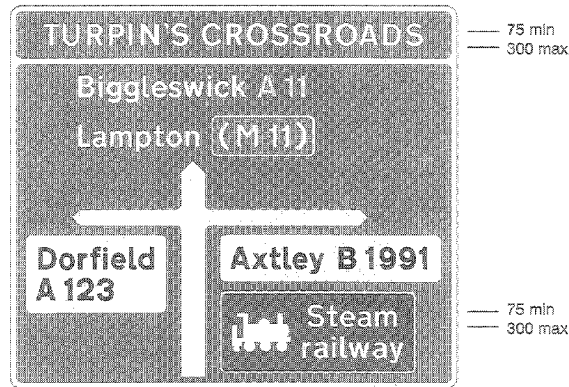

2004

Junction at named crossroads ahead between a primary route leading to a motorway and two non-primary routes, one of which also leads to a tourist attraction

Item	
1	Regulations: None
2	Directions: 11(1)
3	Diagrams: None
4	Permitted variants: Schedule 16, items 3, 5, 16, 18, 19, 20, 21, 23, 24, 25, 26, 27, 28, 29, 30, 31, 32, 33, 34, 36 Junction name may be omitted or shown on 2 lines.
5	Illumination requirements: Schedule 17, item 4

**Status:** This is the original version (as it was originally made). This item of legislation is currently only available in its original format.

SCHEDULE 7 PART I PRIMARY ROUTE DIRECTIONAL SIGNS (contd.)

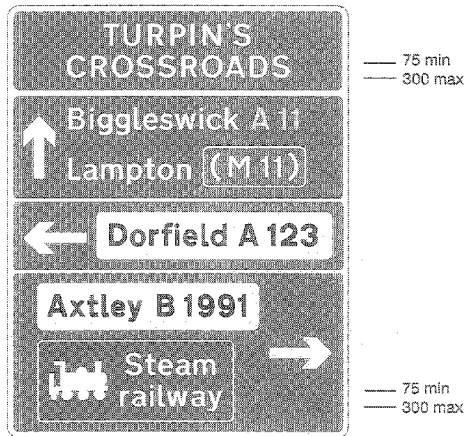

2005  
Same as diagram 2004

Item	
1	Regulations: None
2	Directions: 11(1)
3	Diagrams: None
4	Permitted variants: Schedule 16, items 3, 5, 12, 16, 19, 20, 21, 23, 24, 25, 26, 27, 28, 29, 30, 31, 32, 33, 34, 36 Junction name may be omitted or be shown on one line.
5	Illumination requirements: Schedule 17, item 4



2006  
Junction ahead with a non-primary route

Item	
1	Regulations: None
2	Directions: 11(1)
3	Diagrams: None
4	Permitted variants: Schedule 16, items 3, 5, 12, 19, 20, 23, 24, 25, 26, 27, 30, 31, 32, 34
5	Illumination requirements: Schedule 17, item 4



**Status:** This is the original version (as it was originally made). This item of legislation is currently only available in its original format.

SCHEDULE 7 PART I PRIMARY ROUTE DIRECTIONAL SIGNS (contd.)

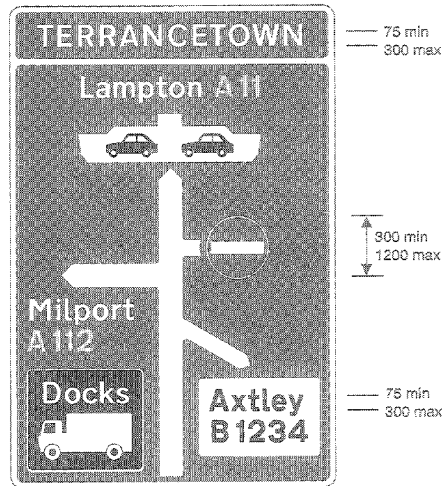

Item	
1	Regulations: None
2	Directions: 7, 11(1)
3	Diagrams: None
4	Permitted variants: Schedule 16, items 3, 5, 16, 18, 19, 20, 21, 23, 24, 26, 27, 28, 30, 31, 32, 34, 35 Location names may be omitted
5	Illumination requirements: Schedule 17, item 4

2007

Staggered junctions ahead between a primary route leading to a car ferry, a primary route which is the recommended route for goods vehicles to take to the docks, a non-primary route and a road to which entry is prohibited, in the village, town or suburb whose name is indicated at the top of the sign

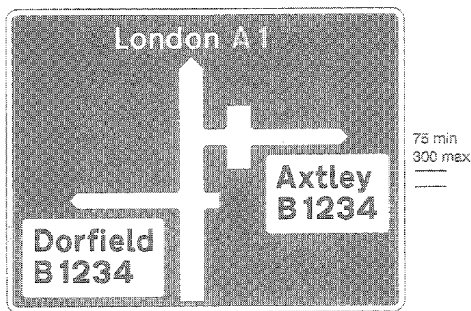

Item	
1	Regulations: None
2	Directions: 11(1)
3	Diagrams: None
4	Permitted variants: Schedule 16, items 3, 5, 16, 18, 19, 20, 21, 23, 24, 25, 26, 27, 30, 31, 32, 34, 35, 36
5	Illumination requirements: Schedule 17, item 4

2008

Staggered junction ahead at which a dual carriageway primary route is crossed by a non-primary route

**Status:** This is the original version (as it was originally made). This item of legislation is currently only available in its original format.

SCHEDULE 7 PART I PRIMARY ROUTE DIRECTIONAL SIGNS (contd.)



2009

Gyratory system ahead on a primary route which has junctions with a non-primary route and with another road along which there is a prohibition on vehicle entry at a specified distance from the junction

Item	
1	Regulations: None
2	Directions: 7, 11(1)
3	Diagrams: None
4	Permitted variants: Schedule 16, items 3, 5, 16, 18, 19, 20, 21, 23, 24, 25, 26, 27, 30, 31, 32, 34, 35, 36
5	Illumination requirements: Schedule 17, item 4

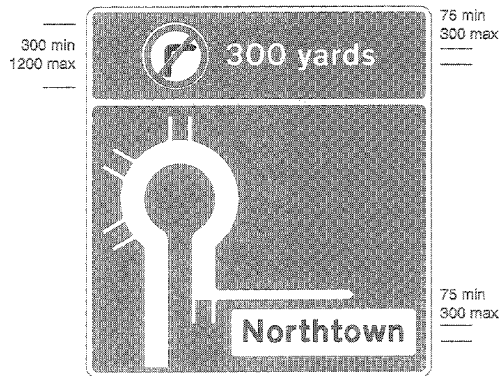

Item	
1	Regulations: None
2	Directions: 7, 11(1)
3	Diagrams: None
4	Permitted variants: Schedule 16, items 6, 16, 18, 19, 20, 23, 24, 26, 26, 27, 30, 34 The diagram 812 symbol may be varied to a diagram 613 or 614 symbol
5	Illumination requirements: Schedule 17, item 4

2010

Distance to a prohibited movement and direction to the destination shown, avoiding that prohibition

**Status:** This is the original version (as it was originally made). This item of legislation is currently only available in its original format.

SCHEDULE 7 PART I PRIMARY ROUTE DIRECTIONAL SIGNS (contd.)

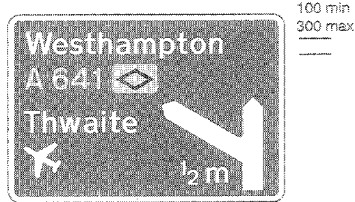

100 min  
300 max

2011  
Grade separated junction 1/2 mile ahead of a primary route with another primary route which leads to an airport and which forms part of an emergency diversion route

Item	
1	Regulations: None
2	Directions: 11(1)
3	Diagrams: None
4	Permitted variants: Schedule 16, items 7, 19, 20, 21, 23, 24, 25, 26, 30, 31, 34, 35
5	Illumination requirements: Schedule 17, item 4

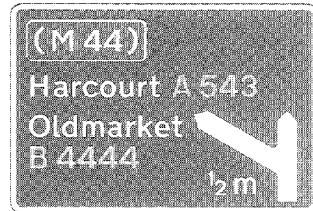

100 min  
300 max

2012  
Grade separated junction 1/2 mile ahead of a primary route with another primary route which leads to a motorway and with a non-primary route

Item	
1	Regulations: None
2	Directions: 11(1)
3	Diagrams: None
4	Permitted variants: Schedule 16, items 7, 19, 20, 21, 23, 24, 25, 26, 30, 31, 34, 35
5	Illumination requirements: Schedule 17, item 4

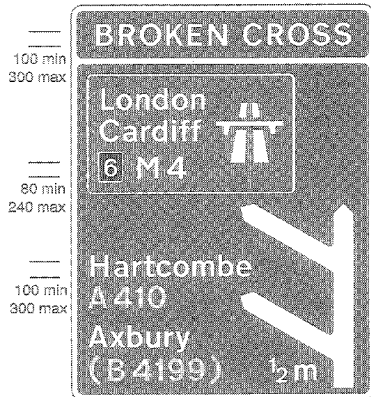

100 min  
300 max

80 min  
240 max

100 min  
300 max

2013  
Two grade separated junctions in quick succession 1/2 mile ahead, one with a primary route which leads to a non-primary route and the other with a motorway at the junction whose name is indicated at the top of the sign

Item	
1	Regulations: None
2	Directions: 11(1)
3	Diagrams: None
4	Permitted variants: Schedule 16, items 7, 19, 20, 21, 23, 24, 25, 26, 30, 31, 34 Junction name may be omitted or shown on two lines.
5	Illumination requirements: Schedule 17, item 4

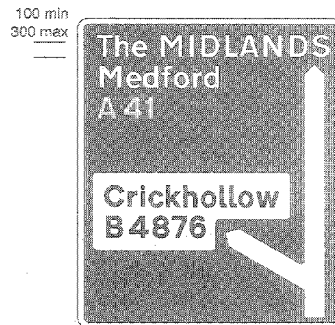

100 min  
300 max

2014  
Grade separated junction of a primary route with a non-primary route

Item	
1	Regulations: None
2	Directions: 11(1)
3	Diagrams: None
4	Permitted variants: Schedule 16, items 19, 20, 21, 23, 24, 25, 26, 30, 31, 32, 34
5	Illumination requirements: Schedule 17, item 4

**Status:** This is the original version (as it was originally made). This item of legislation is currently only available in its original format.

SCHEDULE 7 PART 1 PRIMARY ROUTE DIRECTIONAL SIGNS (contd.)

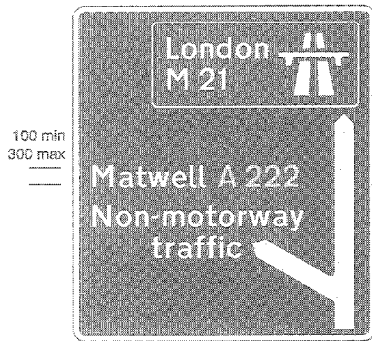

2015  
Grade separated junction ahead of a primary route, which leads directly onto a motorway, with another primary route which should be followed by traffic not wishing or permitted to use the motorway

Item	
1	Regulations: None
2	Directions: 11(1)
3	Diagrams: None
4	Permitted variants: Schedule 16, items 19, 20, 21, 23, 24, 25, 26, 30, 31, 32, 34, 35 Distance to junction may be added.
5	Illumination requirements: Schedule 17, item 4

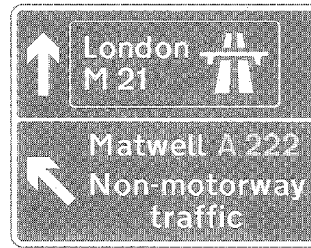

2016  
Same as diagram 2015

Item	
1	Regulations: None
2	Directions: 11(1)
3	Diagrams: None
4	Permitted variants: Schedule 16, items 19, 20, 21, 23, 24, 25, 26, 30, 31, 32, 34, 35
5	Illumination requirements: Schedule 17, item 4

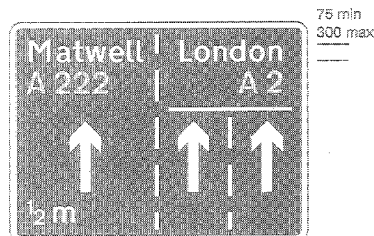

2017  
Junction 1/2 mile ahead where one lane of a primary route leaves that route and leads to another primary route

Item	
1	Regulations: None
2	Directions: 11(1)
3	Diagrams: None
4	Permitted variants: Schedule 16, items 7, 15, 19, 20, 21, 23, 24, 25, 26, 27, 30, 31, 32, 34, 35, 36
5	Illumination requirements: Schedule 17, item 4

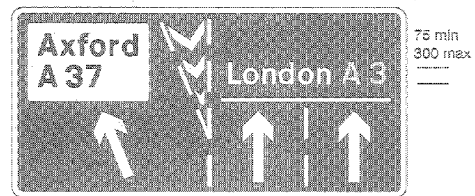

2018  
Junction where one lane of a primary route leaves that route and leads to a non-primary route

Item	
1	Regulations: None
2	Directions: 11(1)
3	Diagrams: None
4	Permitted variants: Schedule 16, items 15, 19, 20, 21, 23, 24, 25, 26, 27, 30, 31, 32, 34
5	Illumination requirements: Schedule 17, item 4

**Status:** This is the original version (as it was originally made). This item of legislation is currently only available in its original format.

SCHEDULE 7 PART 1 PRIMARY ROUTE DIRECTIONAL SIGNS (contd.)

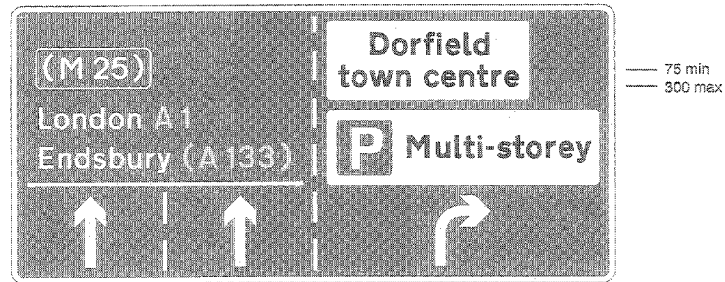

2019

Junction where one lane of a primary route is reserved for traffic turning onto a non-primary route; the primary route leads to a motorway

Item	
1	Regulations: None
2	Directions: 11(1)
3	Diagrams: None
4	Permitted variants: Schedule 16, items 12, 16, 19, 20, 21, 23, 24, 25, 26, 27, 30, 31, 32, 34, 35, 36
5	Illumination requirements: Schedule 17, item 4

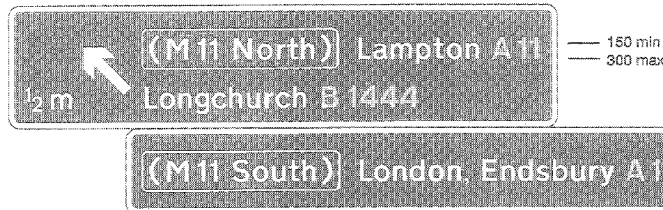

2020

Grade separated junction ahead of a primary route, which leads to one carriageway of a motorway, with another primary route, which leads to the other carriageway of the motorway, and with a non-primary route; the number of lanes on the main carriageway remains the same through the junction

(Gantry-mounted sign)

Item	
1	Regulations: None
2	Directions: 11(1)
3	Diagrams: None
4	Permitted variants: Schedule 16, items 7, 9, 19, 20, 21, 23, 30, 34, 35
5	Illumination requirements: Schedule 17, item 4

**Status:** This is the original version (as it was originally made). This item of legislation is currently only available in its original format.

SCHEDULE 7 PART I PRIMARY ROUTE DIRECTIONAL SIGNS (contd.)

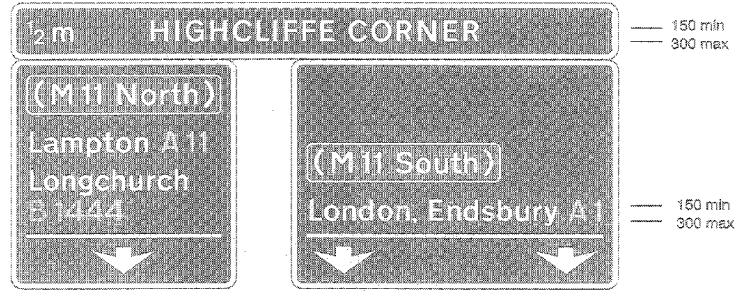

2021

Named grade separated junction on a primary route at a specified distance ahead where the left hand lane leads to a primary route, leading in turn to one carriageway of a motorway, and to a non-primary route, and the two right hand lanes continue on the main primary route and also lead to the other carriageway of the motorway, at the junction whose name is indicated at the top of the sign (Gantry-mounted sign)

Item	
1	Regulations: None
2	Directions: 11(1)
3	Diagrams: None
4	Permitted variants: Schedule 16, items 7, 9, 13, 19, 20, 21, 23, 30, 34 Junction name may be omitted
5	Illumination requirements: Schedule 17, item 4

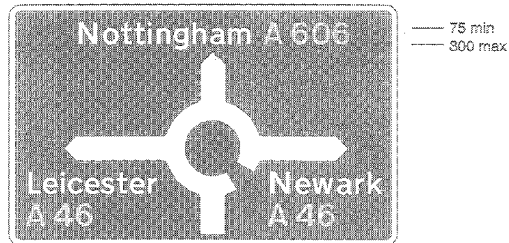

2022

Roundabout ahead at the junction of two primary routes

Item	
1	Regulations: None
2	Directions: 11(1)
3	Diagrams: None
4	Permitted variants: Schedule 16, items 3, 5, 16, 18, 19, 20, 21, 23, 24, 25, 26, 27, 30, 31, 32, 34, 35, 36
5	Illumination requirements: Schedule 17, item 4

**Status:** This is the original version (as it was originally made). This item of legislation is currently only available in its original format.

SCHEDULE 7 PART I PRIMARY ROUTE DIRECTIONAL SIGNS (contd.)

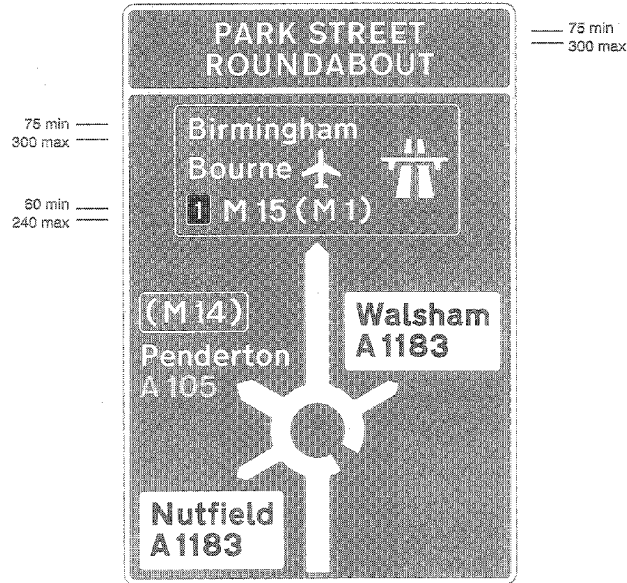

2023

Named roundabout ahead on a primary route with exits to a non-primary route in two directions, a primary route which leads to a motorway, and a motorway which leads to another motorway and an airport

Item	
1	Regulations: None
2	Directions: 11(1)
3	Diagrams: None
4	Permitted variants: Schedule 16, items 3, 5, 16, 18, 19, 20, 21, 23, 24, 25, 26, 27, 30, 31, 32, 34, 36 Junction name may be omitted or shown on one line
5	Illumination requirements: Schedule 17, item 4

**Status:** This is the original version (as it was originally made). This item of legislation is currently only available in its original format.

SCHEDULE 7 PART I PRIMARY ROUTE DIRECTIONAL SIGNS (contd.)

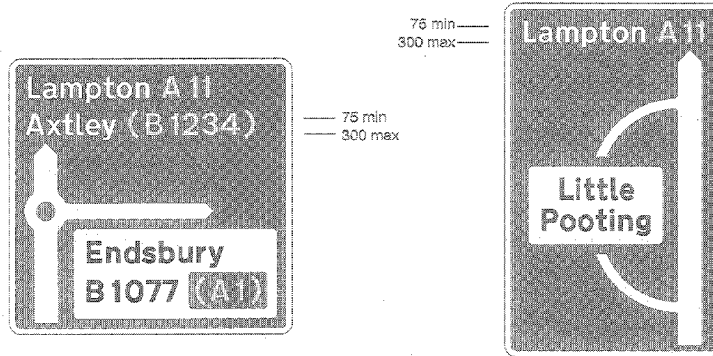

2024  
Mini-roundabout ahead with exits to a primary route, leading to a non-primary route, and a non-primary route, leading to another primary route

Item	
1	Regulations: None
2	Directions: 11(1)
3	Diagrams: None
4	Permitted variants: Schedule 16, items 3, 5, 16, 18, 19, 20, 21, 23, 24, 25, 26, 27, 30, 31, 32, 34, 35, 36
5	Illumination requirements: Schedule 17, item 4

2025  
Junction ahead of a primary route with a non-primary route through a town or village that has been by-passed

Item	
1	Regulations: None
2	Directions: 11(1)
3	Diagrams: None
4	Permitted variants: Schedule 16, items 3, 5, 16, 18, 19, 20, 21, 23, 24, 31, 32, 34, 35
5	Illumination requirements: Schedule 17, item 4

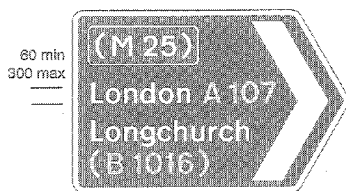

2026  
Direction to a primary route which leads to a motorway and a non-primary route

Item	
1	Regulations: None
2	Directions: 11(2)
3	Diagrams: None
4	Permitted variants: Schedule 16, items 3, 5, 15, 18, 20, 21, 24, 25, 26, 29, 30, 31, 32, 34
5	Illumination requirements: Schedule 17, item 4

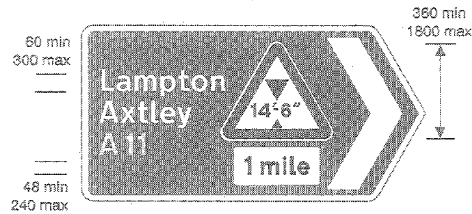

2027  
Direction to a primary route along which there is a low bridge

Item	
1	Regulations: None
2	Directions: 11(2)
3	Diagrams: None
4	Permitted variants: Schedule 16, items 3, 5, 15, 19, 20, 21, 24, 25, 26, 29, 30, 31, 32, 34
5	Illumination requirements: Schedule 17, item 4



**Status:** This is the original version (as it was originally made). This item of legislation is currently only available in its original format.

SCHEDULE 7 PART I PRIMARY ROUTE DIRECTIONAL SIGNS (contd.)

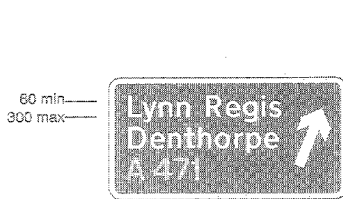

2028  
Direction to a primary route

Item	
1	Regulations: None
2	Directions: 11(2)
3	Diagrams: None
4	Permitted variants: Schedule 16, items 3, 5, 12, 18, 20, 21, 24, 25, 26, 30, 31, 32, 34 Place names may be omitted
5	Illumination requirements: Schedule 17, item 4

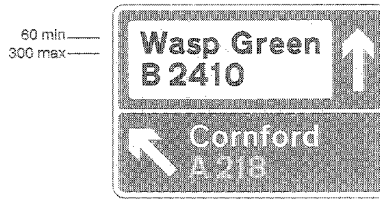

2029  
Directions to a primary route and a non-primary route

Item	
1	Regulations: None
2	Directions: 11(2)
3	Diagrams: None
4	Permitted variants: Schedule 16, items 3, 5, 12, 18, 19, 20, 21, 23, 24, 25, 26, 30, 31, 32, 34
5	Illumination requirements: Schedule 17, item 4

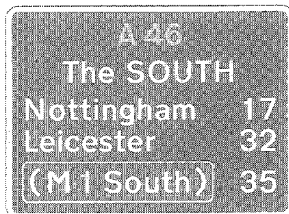

2030  
The number of a primary route with distances to destinations along or reached from that route

Item	
1	Regulations: None
2	Directions: 11(1)
3	Diagrams: None
4	Permitted variants: Schedule 16, items 5, 19, 20, 30
5	Illumination requirements: Schedule 17, item 4

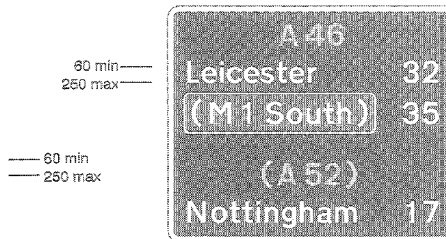

2030.1  
Same as diagram 2030 but with the number of another primary route reached from that route and leading to a named destination

Item	
1	Regulations: None
2	Directions: 11(1)
3	Diagrams: None
4	Permitted variants: Schedule 16, items 5, 19, 20, 30
5	Illumination requirements: Schedule 17, item 4

**Status:** This is the original version (as it was originally made). This item of legislation is currently only available in its original format.

SCHEDULE 7 PART I PRIMARY ROUTE DIRECTIONAL SIGNS (contd.)



Item	
1	Regulations: None
2	Directions: 12(3)
3	Diagrams: None
4	Permitted variants: Schedule 16, items 20, 21 Brackets may be added round the route number to indicate that the road on which the sign is sited leads to the route shown
5	Illumination requirements: Schedule 17, item 4

Item	
1	Regulations: 12(3)
2	Directions: 11(1)
3	Diagrams: None
4	Permitted variants: None
5	Illumination requirements: Schedule 17, item 4

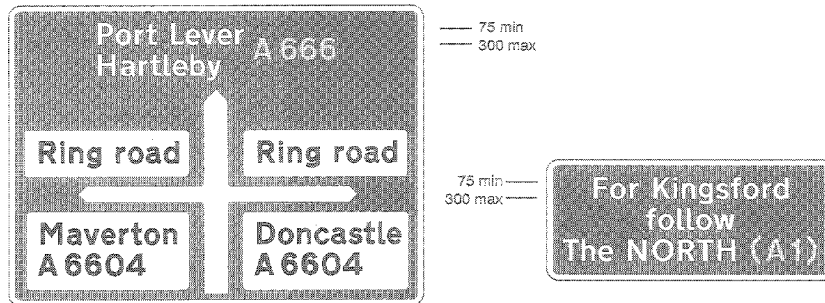

2033  
Crossroads ahead between a primary route and a ring road which is a non-primary route

2034  
Junction ahead indicating the route to be followed for destinations that are not otherwise signed at that junction

Item	
1	Regulations: None
2	Directions: 11(1)
3	Diagrams: None
4	Permitted variants: Schedule 16, items 3, 5, 16, 18, 19, 20, 21, 23, 24, 25, 26, 27, 30, 31, 32, 34, 35, 36
5	Illumination requirements: Schedule 17, item 4

Item	
1	Regulations: None
2	Directions: 11(1)
3	Diagrams: None
4	Permitted variants: Schedule 16, items 10, 20, 30, 34 "follow" and the route may be varied to "leave at next junction" or "leave at" and the name of a junction
5	Illumination requirements: Schedule 17, item 4

**Status:** This is the original version (as it was originally made). This item of legislation is currently only available in its original format.

## PART II

### NON-PRIMARY ROUTE DIRECTIONAL SIGNS

#### SCHEDULE 7 PART II NON-PRIMARY ROUTE DIRECTIONAL SIGNS

Regulation 11(1)

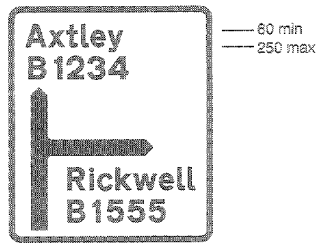

2101  
Junction ahead of two non-primary routes

Item	
1	Regulations: None
2	Directions: 12(1)
3	Diagrams: None
4	Permitted variants: Schedule 16, items 3, 5, 16, 18, 19, 20, 21, 22, 24, 25, 26, 27, 30, 31, 32, 34, 35, 36
5	Illumination requirements: Schedule 17, item 4

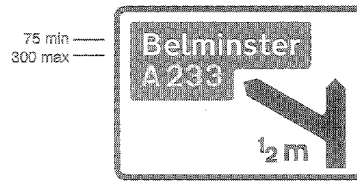

2101.1  
Grade separated junction ahead of a non-primary route and a primary route

Item	
1	Regulations: None
2	Directions: 12(1)
3	Diagrams: None
4	Permitted variants: Schedule 16, items 7, 19, 20, 21, 22, 24, 25, 26, 27, 30, 31, 32, 34, 35
5	Illumination requirements: Schedule 17, item 4

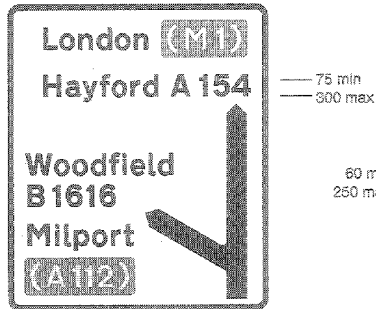

2101.2  
Grade separated junction of a non-primary route leading to a motorway with another non-primary route leading to a primary route

Item	
1	Regulations: None
2	Directions: 12(1)
3	Diagrams: None
4	Permitted variants: Schedule 16, items 19, 20, 21, 22, 24, 25, 26, 27, 30, 31, 32, 34
5	Illumination requirements: Schedule 17, item 4

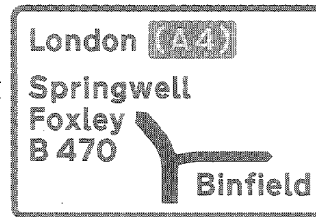

2102  
Junction ahead of two non-primary routes, one of which leads to a primary route

Item	
1	Regulations: None
2	Directions: 12(1)
3	Diagrams: None
4	Permitted variants: Schedule 16, items 3, 5, 16, 18, 19, 20, 21, 22, 23, 24, 25, 26, 27, 30, 31, 32, 34, 35, 36
5	Illumination requirements: Schedule 17, item 4

Status: This is the original version (as it was originally made). This item of legislation is currently only available in its original format.

SCHEDULE 7 PART II NON-PRIMARY ROUTE DIRECTIONAL SIGNS (contd.)

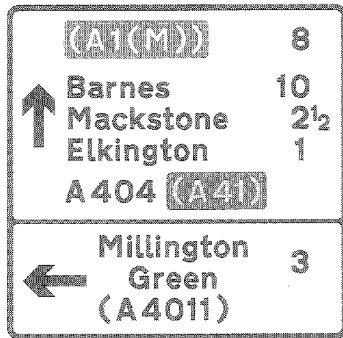

— 60 min  
— 250 max

Item	
1	Regulations: None
2	Directions: 12(1)
3	Diagrams: None
4	Permitted variants: Schedule 16, items 5, 9, 12, 16, 19, 20, 21, 22, 24, 25, 26, 27, 30, 31, 32, 34, 35, 36
5	Illumination requirements: Schedule 17, item 4

2103

Junction ahead of two non-primary routes, one of which leads to a primary route and a motorway

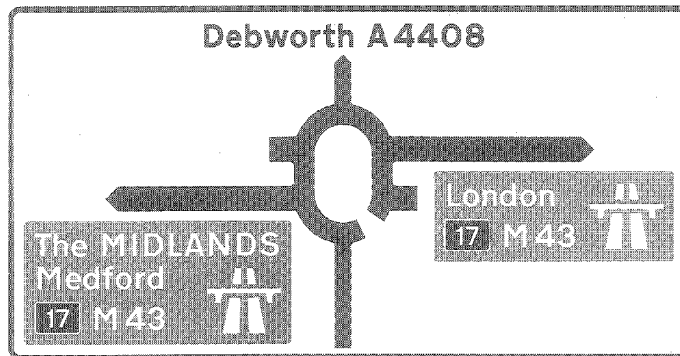

— 60 min  
— 250 max

2104

Junction ahead of a non-primary route with a motorway at the junction whose number is specified

Item	
1	Regulations: None
2	Directions: 12(1)
3	Diagrams: None
4	Permitted variants: Schedule 16, items 3, 5, 16, 18, 19, 20, 21, 22, 24, 25, 26, 27, 30, 31, 32, 34, 35, 36
5	Illumination requirements: Schedule 17, item 4

**Status:** This is the original version (as it was originally made). This item of legislation is currently only available in its original format.

SCHEDULE 7 PART II NON-PRIMARY ROUTE DIRECTIONAL SIGNS (contd.)



Item	
1	Regulations: None
2	Directions: 12(1)
3	Diagrams: None
4	Permitted variants: Schedule 16, items 3, 5, 16, 18, 19, 20, 21, 22, 24, 25, 26, 28, 29, 30, 31, 32, 34, 35, 36
5	Illumination requirements: Schedule 17, item 4

2105

Junction ahead of a non-primary route with an alternative route for pedal cycles

60 min —  
250 max —

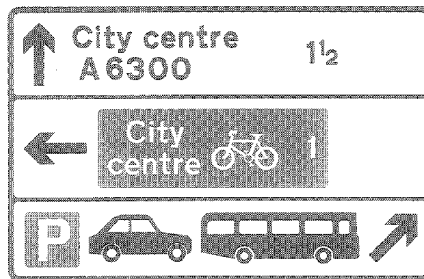

2106

Junction ahead of a non-primary route with an alternative route for pedal cycles and a route leading to parking for cars and buses

Item	
1	Regulations: 24(1)
2	Directions: 12(1)
3	Diagrams: None
4	Permitted variants: Schedule 16, items 5, 9, 12, 16, 18, 20, 21, 22, 24, 25, 26, 28, 29, 30, 31, 32, 34, 35, 36
5	Illumination requirements: Schedule 17, item 4

Status: This is the original version (as it was originally made). This item of legislation is currently only available in its original format.

SCHEDULE 7 PART II NON-PRIMARY ROUTE DIRECTIONAL SIGNS (contd.)

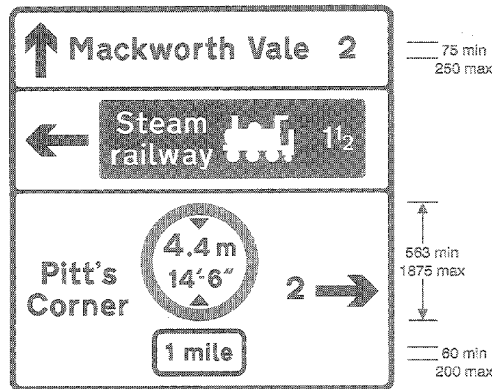

Item	
1	Regulations: None
2	Directions: 7, 12(1)
3	Diagrams: None
4	Permitted variants: Schedule 16, items 5, 9, 12, 16, 19, 20, 21, 22, 25, 26, 27, 28, 29, 30, 31, 32, 33, 34, 35, 36
5	Illumination requirements: Schedule 17, item 4

2107  
Junction ahead of a non-primary route with a route leading to a tourist attraction and another non-primary route on which there is a height restriction

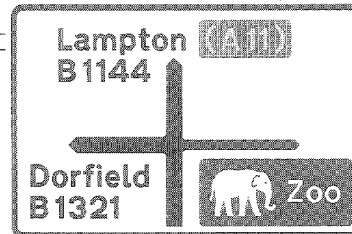
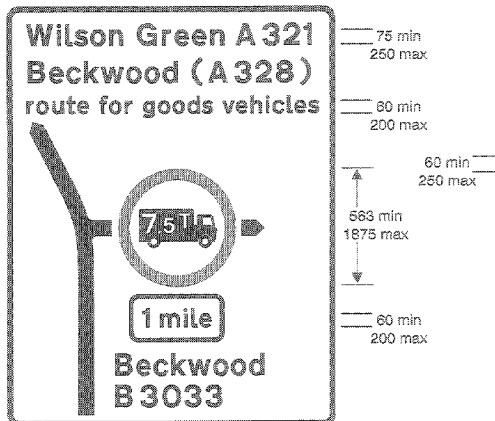

2108  
Junction ahead of two non-primary routes, on one of which there is a weight restriction, and the other is the alternative route to avoid the weight restriction

2109  
Junction ahead of two non-primary routes, one of which leads to a primary route, and a route leading to a tourist attraction

Item	
1	Regulations: None
2	Directions: 7, 12(1)
3	Diagrams: None
4	Permitted variants: Schedule 16, items 3, 5, 16, 18, 19, 20, 21, 22, 24, 25, 26, 27, 28, 30, 31, 32, 34, 35, 36
5	Illumination requirements: Schedule 17, item 4

Item	
1	Regulations: None
2	Directions: 12(1)
3	Diagrams: None
4	Permitted variants: Schedule 16, items 3, 5, 16, 18, 19, 20, 21, 22, 25, 26, 27, 28, 29, 30, 31, 32, 33, 34, 35, 36
5	Illumination requirements: Schedule 17, item 4

**Status:** This is the original version (as it was originally made). This item of legislation is currently only available in its original format.

SCHEDULE 7 PART II NON-PRIMARY ROUTE DIRECTIONAL SIGNS (contd.)

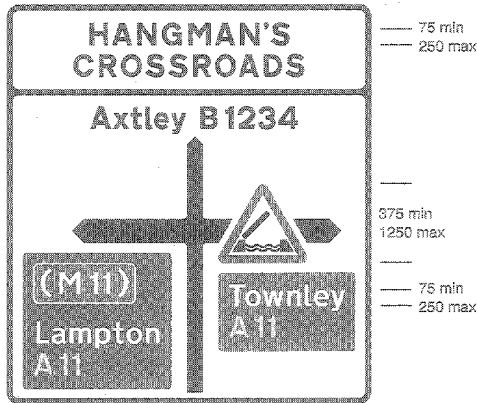

Item	
1	Regulations: None
2	Directions: 12(1)
3	Diagrams: None
4	Permitted variants: Schedule 16, items 3, 5, 16, 18, 19, 20, 21, 22, 24, 25, 26, 27, 30, 31, 32, 34, 36 Junction name may be omitted
5	Illumination requirements: Schedule 17, item 4

2110

Junction at named crossroads ahead of a non-primary route with a primary route, on which in one direction there is a lifting bridge and which in the other direction leads to a motorway

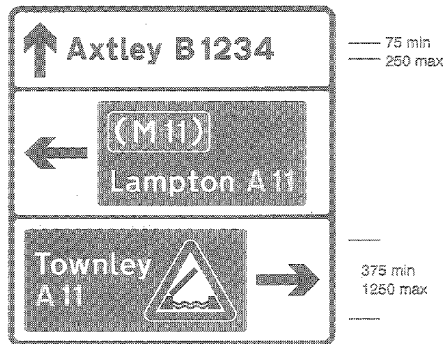

Item	
1	Regulations: None
2	Directions: 12(1)
3	Diagrams: None
4	Permitted variants: Schedule 16, items 3, 5, 12, 16, 19, 20, 21, 22, 24, 25, 26, 27, 29, 30, 31, 32, 34, 35, 36
5	Illumination requirements: Schedule 17, item 4

2111

Junction at crossroads ahead of a non-primary route with a primary route, on which in one direction there is a lifting bridge and which in the other direction leads to a motorway

**Status:** This is the original version (as it was originally made). This item of legislation is currently only available in its original format.

SCHEDULE 7 PART II NON-PRIMARY ROUTE DIRECTIONAL SIGNS (contd.)

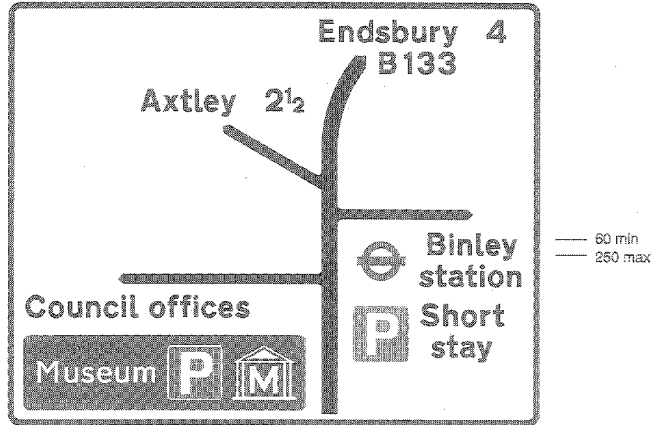

2112

Staggered junctions ahead between four non-primary routes leading to various destinations including parking for a tourist attraction, short stay parking and a London Regional Transport railway station

Item	
1	Regulations: None
2	Directions: 12(1)
3	Diagrams: None
4	Permitted variants: Schedule 16, items 3, 5, 9, 16, 18, 19, 20, 21, 22, 25, 26, 27, 28, 29, 30, 31, 32, 33, 34, 35, 38
5	Illumination requirements: Schedule 17, item 4



**Status:** This is the original version (as it was originally made). This item of legislation is currently only available in its original format.

SCHEDULE 7 PART II NON-PRIMARY ROUTE DIRECTIONAL SIGNS (contd.)

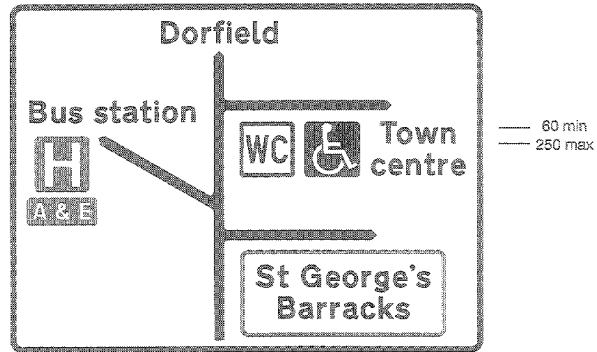

2113

Staggered junctions ahead between four non-primary routes leading to various destinations, including a Ministry of Defence establishment, a hospital with accident and emergency facilities and public toilets with facilities for disabled people

Item	
1	Regulations: None
2	Directions: 12(1)
3	Diagrams: None
4	Permitted variants: Schedule 16, items 3, 5, 16, 18, 19, 20, 21, 22, 24, 25, 27, 28, 29, 30, 31, 32, 34, 35, 36
5	Illumination requirements: Schedule 17, item 4

**Status:** This is the original version (as it was originally made). This item of legislation is currently only available in its original format.

SCHEDULE 7 PART II NON-PRIMARY ROUTE DIRECTIONAL SIGNS (contd.)

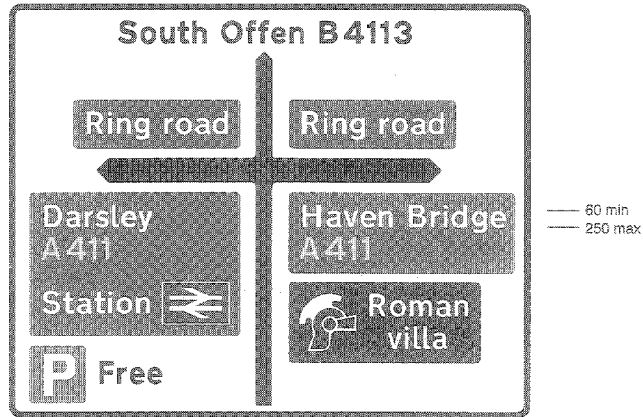

2113.1

Junction at crossroads ahead between a non-primary route and a primary route which is a ring road and which also leads to a railway station and free parking in one direction and to a tourist attraction in the other

Item	
1	Regulations: None
2	Directions: 12(1)
3	Diagrams: None
4	Permitted variants: Schedule 16, items 3, 5, 16, 18, 19, 20, 21, 22, 25, 26, 27, 28, 29, 30, 31, 32, 33, 34, 35, 36
5	Illumination requirements: Schedule 17, item 4

**Status:** This is the original version (as it was originally made). This item of legislation is currently only available in its original format.

SCHEDULE 7 PART II NON-PRIMARY ROUTE DIRECTIONAL SIGNS (contd.)

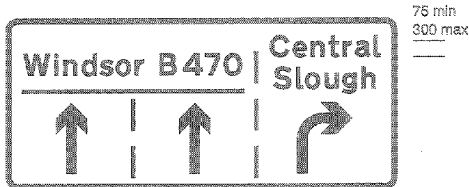

2114  
Junction ahead where one lane of a non-primary route is reserved for traffic turning to the right

Item	
1	Regulations: None
2	Directions: 12(1)
3	Diagrams: None
4	Permitted variants: Schedule 16, items 12, 16, 19, 20, 21, 22, 24, 25, 26, 27, 30, 31, 32, 34, 35, 36
5	Illumination requirements: Schedule 17, item 4

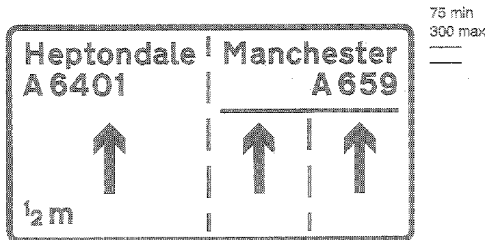

2115  
Grade separated junction 1/2 mile ahead where one lane of a non-primary route is reserved for traffic turning onto another non-primary route

Item	
1	Regulations: None
2	Directions: 12(1)
3	Diagrams: None
4	Permitted variants: Schedule 16, items 7, 16, 19, 20, 21, 22, 24, 25, 26, 27, 30, 31, 32, 34, 35, 36
5	Illumination requirements: Schedule 17, item 4

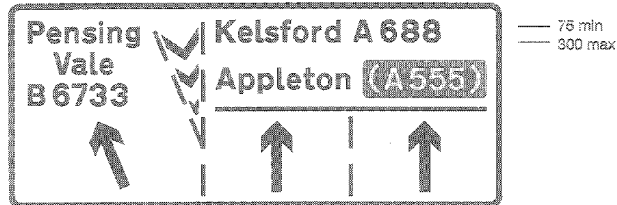

2115.1  
Grade separated junction where one lane of a non-primary route is reserved for traffic turning onto another non-primary route

Item	
1	Regulations: None
2	Directions: 12(1)
3	Diagrams: None
4	Permitted variants: Schedule 16, items 16, 19, 20, 21, 22, 24, 25, 26, 27, 30, 31, 32, 34
5	Illumination requirements: Schedule 17, item 4

**Status:** This is the original version (as it was originally made). This item of legislation is currently only available in its original format.

SCHEDULE 7 PART II NON-PRIMARY ROUTE DIRECTIONAL SIGNS (contd.)

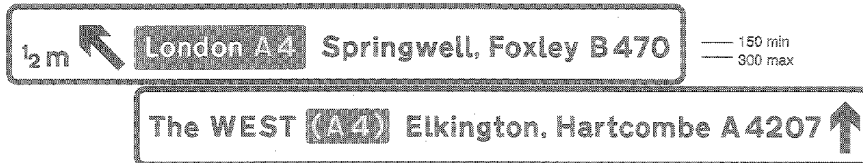

2116

Grade separated junction ahead of two non-primary routes, both of which lead to a primary route and the number of lanes on the main carriageway remains the same through the junction (Gantry-mounted sign)

Item	
1	Regulations: None
2	Directions: 12(1)
3	Diagrams: None
4	Permitted variants: Schedule 16, items 7, 8, 19, 20, 21, 22, 30, 34, 35
5	Illumination requirements: Schedule 17, item 4



2117

Grade separated junction ahead where the left hand lane of a non-primary route leads to another non-primary route, which in turn leads to a primary route and the two right hand lanes lead along the main route to another primary route (Gantry-mounted sign)

Item	
1	Regulations: None
2	Directions: 12(1)
3	Diagrams: None
4	Permitted variants: Schedule 16, items 7, 9, 19, 18, 20, 21, 22, 30, 34, 35
5	Illumination requirements: Schedule 17, item 4

**Status:** This is the original version (as it was originally made). This item of legislation is currently only available in its original format.

SCHEDULE 7 PART II NON-PRIMARY ROUTE DIRECTIONAL SIGNS (contd.)



2118

Roundabout ahead with a dedicated lane to a primary route which leads to a motorway and exits to two non-primary routes, one of which leads to car parking in the town centre and to a British Rail station

Item	
1	Regulations: None
2	Directions: 12(1)
3	Diagrams: None
4	Permitted variants: Schedule 16, items 3, 5, 16, 18, 19, 20, 21, 22, 24, 25, 26, 27, 29, 30, 31, 32, 34, 35, 36
5	Illumination requirements: Schedule 17, item 4

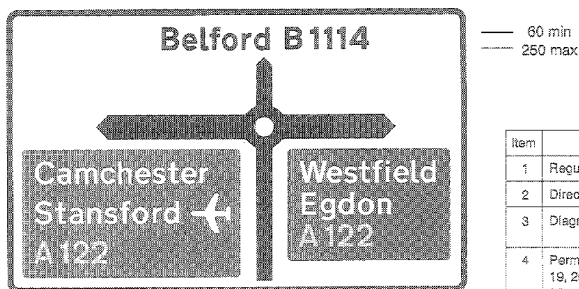

2119

Mini-roundabout ahead with exits to a non-primary route and a primary route in two directions, one of which leads to an airport

Item	
1	Regulations: None
2	Directions: 12(1)
3	Diagrams: None
4	Permitted variants: Schedule 16, items 3, 5, 16, 18, 19, 20, 21, 22, 24, 25, 26, 27, 29, 31, 32, 34, 35, 36
5	Illumination requirements: Schedule 17, item 4

**Status:** This is the original version (as it was originally made). This item of legislation is currently only available in its original format.

SCHEDULE 7 PART II NON-PRIMARY ROUTE DIRECTIONAL SIGNS (contd.)

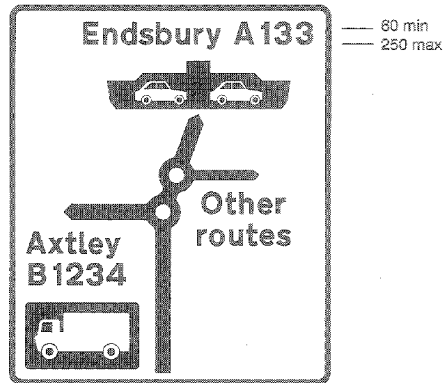

Item	
1	Regulations: None
2	Directions: 12(1)
3	Diagrams: None
4	Permitted variants: Schedule 16, items 3, 5, 16, 18, 19, 20, 21, 22, 24, 28, 27, 26, 29, 30, 31, 32, 34, 35, 38
5	Illumination requirements: Schedule 17, item 4

2120

Double mini-roundabout ahead with exits to three non-primary routes, one of which leads to a car ferry and another is an advisory lorry route

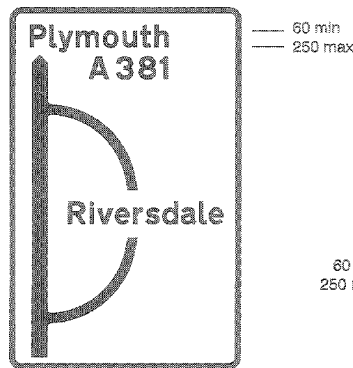

2121

Junction ahead of a non-primary route with another non-primary route leading to a town or village that has been bypassed

Item	
1	Regulations: None
2	Directions: 12(1)
3	Diagrams: None
4	Permitted variants: Schedule 16, items 3, 5, 16, 18, 19, 20, 21, 22, 24, 31, 32, 34, 35
5	Illumination requirements: Schedule 17, item 4

205



2122

Sharp bend in main route at a junction ahead with a minor road

Item	
1	Regulations: None
2	Directions: 12(1)
3	Diagrams: None
4	Permitted variants: Schedule 16, items 3, 5, 16, 18, 19, 20, 21, 22, 24, 25, 26, 27, 30, 31, 32, 34
5	Illumination requirements: Schedule 17, item 4

206

**Status:** This is the original version (as it was originally made). This item of legislation is currently only available in its original format.

SCHEDULE 7 PART II NON-PRIMARY ROUTE DIRECTIONAL SIGNS (contd.)

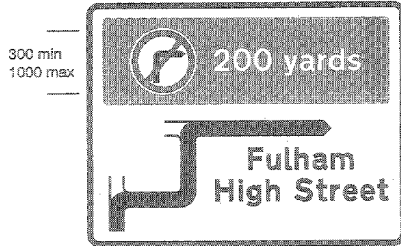

300 min  
1000 max

75 min  
250 max

2123

Distance to a prohibited movement and direction to the destination shown avoiding that prohibition

Item	
1	Regulations: None
2	Directions: 7, 12(1)
3	Diagrams: None
4	Permitted variants: Schedule 16, items 6, 16, 18, 19, 21, 22, 24, 25, 26, 27, 30, 34 The diagram 612 symbol may be varied to a diagram 613 or 614 symbol
5	Illumination requirements: Schedule 17, item 4

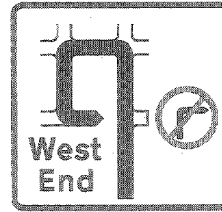

75 min  
250 max

300 min  
1000 max

2124

Direction to the destination shown avoiding a prohibited movement ahead

Item	
1	Regulations: None
2	Directions: 7, 12(1)
3	Diagrams: None
4	Permitted variants: Schedule 16, items 16, 18, 19, 21, 22, 24, 25, 26, 27, 30, 34 The diagram 612 symbol may be varied to a diagram 613 or 614 symbol
5	Illumination requirements: Schedule 17, item 4

50 min  
250 max



2125

Direction and distance to a destination on a non-primary route

Item	
1	Regulations: None
2	Directions: 12(2)
3	Diagrams: None
4	Permitted variants: Schedule 16, items 5, 9, 15, 19, 20, 21, 22, 24, 30, 31, 32, 34
5	Illumination requirements: Schedule 17, item 4

**Status:** This is the original version (as it was originally made). This item of legislation is currently only available in its original format.

SCHEDULE 7 PART II NON-PRIMARY ROUTE DIRECTIONAL SIGNS (contd.)



2126  
Direction and distances to a destination on a non-primary route and to a tourist attraction

Item	
1	Regulations: None
2	Directions: 12(2)
3	Diagrams: None
4	Permitted variants: Schedule 16, items 5, 9, 15, 19, 20, 21, 22, 24, 30, 31, 32, 34
5	Illumination requirements: Schedule 17, item 4

50 min  
250 max

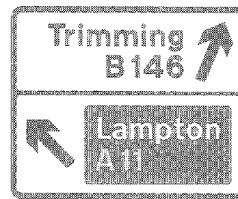

2127  
Directions to non-primary and primary routes

Item	
1	Regulations: None
2	Directions: 12(2)
3	Diagrams: None
4	Permitted variants: Schedule 16, items 3, 5, 12, 16, 19, 20, 21, 22, 24, 25, 26, 27, 30, 31, 32, 34 Place names may be omitted when the sign is varied to indicate only one direction
5	Illumination requirements: Schedule 17, item 4

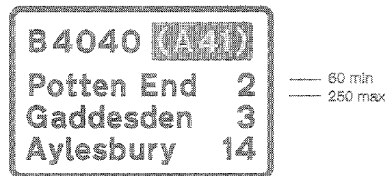

2128  
The number of a non-primary route leading to a primary route with destinations and distances

Item	
1	Regulations: None
2	Directions: 12(1)
3	Diagrams: None
4	Permitted variants: Schedule 16, items 5, 19, 20, 21, 22, 30
5	Illumination requirements: Schedule 17, item 4



2129  
The number of a non-primary route

Item	
1	Regulations: None
2	Directions: 12(3)
3	Diagrams: None
4	Permitted variants: Schedule 16, items 20, 21, 22 Brackets may be added round the route number to indicate that the road on which the sign is sited leads to the route shown
5	Illumination requirements: Schedule 17, item 4



**Status:** This is the original version (as it was originally made). This item of legislation is currently only available in its original format.

SCHEDULE 7 PART II NON-PRIMARY ROUTE DIRECTIONAL SIGNS (contd.)

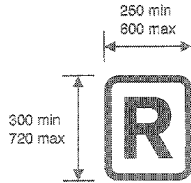

2130  
Non-primary route forming part of a ring road

Item	
1	Regulations: 12(8)
2	Directions: 12(1)
3	Diagrams: None
4	Permitted variants: None
5	Illumination requirements: Schedule 17, item 4



2131  
Alternative route from junction ahead to place named

Item	
1	Regulations: None
2	Directions: 12(1)
3	Diagrams: None
4	Permitted variants: Schedule 16, items 3, 5, 12, 19, 20, 21, 22, 32
5	Illumination requirements: Schedule 17, item 4



2132  
Direction of alternative route to place named

Item	
1	Regulations: None
2	Directions: 12(2)
3	Diagrams: None
4	Permitted variants: Schedule 16, items 3, 5, 15, 19, 20, 21, 22, 32
5	Illumination requirements: Schedule 17, item 4



2133  
Junction ahead leading to a London Regional Transport railway station

Item	
1	Regulations: None
2	Directions: 12(1)
3	Diagrams: None
4	Permitted variants: Schedule 16, items 3, 5, 12, 19, 20. The London Transport symbol may be replaced by the British Rail or a PTE symbol. The British Rail symbol may be used in addition to the London Transport or a PTE symbol.
5	Illumination requirements: Schedule 17, item 4

**Status:** This is the original version (as it was originally made). This item of legislation is currently only available in its original format.

SCHEDULE 7 PART II NON-PRIMARY ROUTE DIRECTIONAL SIGNS (contd.)



2134  
Direction to a railway station

Item	
1	Regulations: None
2	Directions: 12(2)
3	Diagrams: None
4	Permitted variants: Schedule 16, items 3, 6, 15, 19, 29 The PTE symbol may be replaced by another PTE symbol or London Transport symbol or omitted. The British Rail symbol may be omitted.
5	Illumination requirements: Schedule 17, item 4

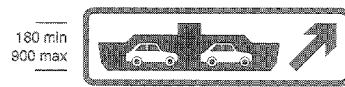

2135  
Junction ahead leading to a car ferry

Item	
1	Regulations: None
2	Directions: 12(1)
3	Diagrams: None
4	Permitted variants: Schedule 16, items 12, 28 The left hand car symbol may be replaced by the lorry symbol. The two symbols may be omitted and the words "Pedestrian ferry" added on the boat symbol. The name of the ferry or quay may be added above the boat symbol.
5	Illumination requirements: Schedule 17, item 4

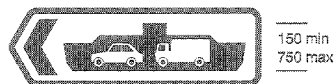

2136  
Direction to a vehicle ferry

Item	
1	Regulations: None
2	Directions: 12(2)
3	Diagrams: None
4	Permitted variants: Schedule 16, items 15, 28 The right hand symbol may be varied to a car symbol. The two symbols may be omitted and the words "Pedestrian ferry" added on the boat symbol. The name of the ferry or quay may be added above the boat symbol.
5	Illumination requirements: Schedule 17, item 4



2137  
Direction to a shopping area which provides a "Shopmobility" service for the disabled approved by the National Federation of Shopmobility

Item	
1	Regulations: None
2	Directions: 12(2)
3	Diagrams: None
4	Permitted variants: Schedule 16, items 15, 28, 29
5	Illumination requirements: Schedule 17, item 4

**Status:** This is the original version (as it was originally made). This item of legislation is currently only available in its original format.

SCHEDULE 7 PART II NON-PRIMARY ROUTE DIRECTIONAL SIGNS (contd.)

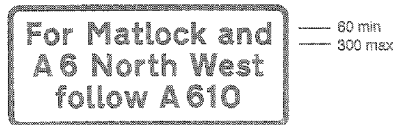

2138

indication of route to be followed at junction ahead for destinations that are not otherwise shown on the signs at that junction.

Item	
1	Regulations: None
2	Directions: 12(1)
3	Diagrams: None
4	Permitted variants: Schedule 16, items 19, 20, 21, 22, 30, 34 "follow" and the route may be varied to "leave at next junction" or "leave at" and the name of a junction
5	Illumination requirements: Schedule 17, item 4

**Status:** This is the original version (as it was originally made). This item of legislation is currently only available in its original format.

## PART III

### TOURIST ATTRACTION SIGNS

(other than on motorways or for pedestrians)

#### SCHEDULE 7 PART III TOURIST ATTRACTION SIGNS (other than on motorways or for pedestrians)

Regulation 11(1)



60 min  
250 max

60 min  
300 max



2201  
Distance ahead to a tourist attraction

2202  
Junction ahead leading to a tourist attraction

Item	
1	Regulations: None
2	Directions: 12(3)
3	Diagrams: None
4	Permitted variants: Schedule 16, items 6, 10, 11, 19, 28, 33
5	Illumination requirements: Schedule 17, item 8

Item	
1	Regulations: None
2	Directions: 12(3)
3	Diagrams: None
4	Permitted variants: Schedule 16, items 6, 9, 12, 19, 28, 29, 31, 32, 33, 34
5	Illumination requirements: Schedule 17, item 9



50 min  
250 max



50 min  
250 max

2203  
Direction and distance to a tourist attraction

2204  
Direction and distance to a Tourist Information Point or Centre

Item	
1	Regulations: None
2	Directions: 12(3)
3	Diagrams: None
4	Permitted variants: Schedule 16, items 6, 9, 15, 19, 24, 31, 32, 34
5	Illumination requirements: Schedule 17, item 9

Item	
1	Regulations: None
2	Directions: 12(3)
3	Diagrams: None
4	Permitted variants: Schedule 16, items 6, 9, 15, 29 The word "centre" may be added
5	Illumination requirements: Schedule 17, item 9

**Status:** This is the original version (as it was originally made). This item of legislation is currently only available in its original format.

SCHEDULE 7 PART III TOURIST ATTRACTION SIGNS (contd.)

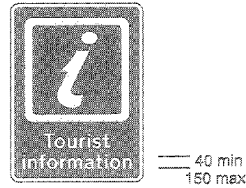

2205  
Location of a Tourist Information Point or Centre

Item	
1	Regulations: None
2	Directions: 12(5)
3	Diagrams: None
4	Permitted variants: Schedule 16, items 3, 6, 11 The word "centre" may be added. The name of a geographical area may be added.
5	Illumination requirements: Schedule 17, item 9

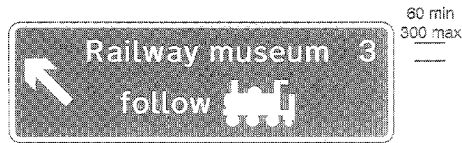

2206  
Junction ahead leading to a tourist attraction where the route is subsequently indicated by a symbol

Item	
1	Regulations: None
2	Directions: 12(3)
3	Diagrams: None
4	Permitted variants: Schedule 16, items 5, 9, 12, 19, 28, 33
5	Illumination requirements: Schedule 17, item 9

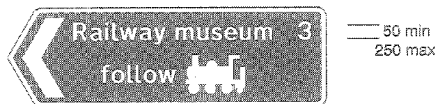

2207  
Direction and distance to a tourist attraction where the route is subsequently indicated by a symbol

Item	
1	Regulations: None
2	Directions: 12(3)
3	Diagrams: None
4	Permitted variants: Schedule 16, items 5, 9, 15, 18, 28, 33
5	Illumination requirements: Schedule 17, item 9



2208  
Direction to a tourist attraction indicated by a symbol

Item	
1	Regulations: 12(3)
2	Directions: 12(3)
3	Diagrams: None
4	Permitted variants: Schedule 16, items 15, 28, 33
5	Illumination requirements: Schedule 17, item 9

**Status:** This is the original version (as it was originally made). This item of legislation is currently only available in its original format.

SCHEDULE 7 PART III TOURIST ATTRACTION SIGNS (contd.)

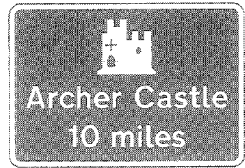

60 min  
250 max



60 min  
300 max

2209

Distance ahead to a tourist attraction

Item	
1	Regulations: None
2	Directions: 12(3)
3	Diagrams: None
4	Permitted variants: Schedule 16, items 5, 19, 33 Opening times may be added. The distance may be replaced by the word "CLOSED"
5	Illumination requirements: Schedule 17, item 9

2210

Junction ahead leading to or along a route passing through places of interest

Item	
1	Regulations: None
2	Directions: 12(3)
3	Diagrams: None
4	Permitted variants: Schedule 16, items 12, 19, 29, 33 The rose symbol may be varied to the thistle symbol in Scotland or the dragon symbol in Wales. The cycle symbol may be added.
5	Illumination requirements: Schedule 17, item 9



60 min  
250 max



60 min  
250 max

2211

Direction to or along a route passing through places of interest

Item	
1	Regulations: None
2	Directions: 12(3)
3	Diagrams: None
4	Permitted variants: Schedule 16, items 15, 19, 29, 33 Same as diagram 2210
5	Illumination requirements: Schedule 17, item 9

2212

Direction along a route passing through places of interest

Item	
1	Regulations: None
2	Directions: 12(3)
3	Diagrams: None
4	Permitted variants: Schedule 16, items 15, 33 Same as diagram 2210
5	Illumination requirements: Schedule 17, item 9

**Status:** This is the original version (as it was originally made). This item of legislation is currently only available in its original format.

SCHEDULE 7 PART III TOURIST ATTRACTION SIGNS (contd.)

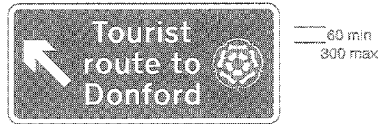

2213  
Junction ahead leading to a route of special interest to tourists

Item	
1	Regulations: None
2	Directions: 12(3)
3	Diagrams: None
4	Permitted variants: Schedule 16, items 3, 5, 12, 19, 28, 33 The place name and the word "to" may be omitted or replaced by a geographical or historical title. "Tourist" may be varied to "Scenic" or "Coastal". The rose symbol may be varied to the thistle symbol in Scotland or the dragon symbol in Wales. "route" may be varied to "trail" in Scotland.
5	Illumination requirements: Schedule 17, item 9



2214  
Direction to or along a route of special interest to tourists

Item	
1	Regulations: None
2	Directions: 12(3)
3	Diagrams: None
4	Permitted variants: Schedule 16, items 3, 5, 15, 16, 28, 33 Same as diagram 2213
5	Illumination requirements: Schedule 17, item 9

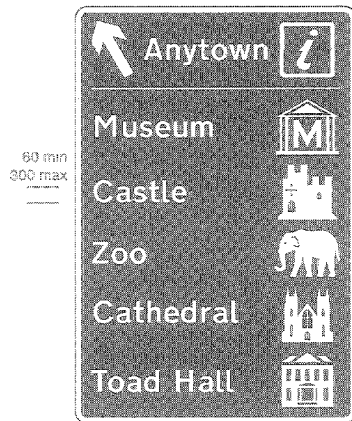

2215  
Junction ahead leading to a town or geographical area in England or Scotland containing several tourist attractions and a Tourist Information Point or Centre

Item	
1	Regulations: None
2	Directions: 12(3)
3	Diagrams: None
4	Permitted variants: Schedule 10, items 12, 19, 28, 29, 33
5	Illumination requirements: Schedule 17, item 9

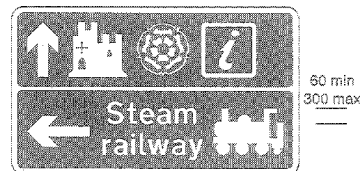

2216  
Junction ahead leading to tourist attractions and a Tourist Information Point or Centre reached in different directions

Item	
1	Regulations: None
2	Directions: 12(3)
3	Diagrams: None
4	Permitted variants: Schedule 16, items 3, 6, 12, 16, 19, 28, 29, 33
5	Illumination requirements: Schedule 17, item 9

214

**Status:** This is the original version (as it was originally made). This item of legislation is currently only available in its original format.

## PART IV SERVICES SIGNS (other than on motorways)

### SCHEDULE 7 PART IV SERVICES SIGNS (other than on motorways)

Regulation 11(f)

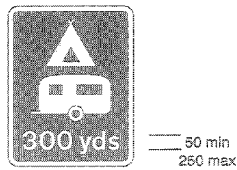

2301

Distance ahead to a camping and caravan site licensed under the Caravan Sites and Control of Development Act 1960 and/or the Public Health Act 1936 and having a minimum of 20 pitches for casual overnight use

Item	
1	Regulations: None
2	Directions: 12(3)
3	Diagrams: None
4	Permitted variants: Schedule 16, items 6, 10, 11 Either the caravan or the tent symbol may be omitted
5	Illumination requirements: Schedule 17, item 4



2302

Direction and distance to a camping and caravan site as defined in the caption under diagram 2301

Item	
1	Regulations: None
2	Directions: 12(3)
3	Diagrams: None
4	Permitted variants: Schedule 16, items 6, 9, 15 Same as diagram 2301
5	Illumination requirements: Schedule 17, item 4

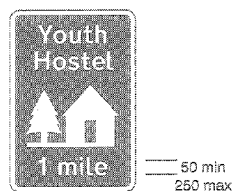

2303

Distance ahead to a hostel managed by the Youth Hostels Association or the Scottish Youth Hostels Association

Item	
1	Regulations: None
2	Directions: 12(3)
3	Diagrams: None
4	Permitted variants: Schedule 16, items 6, 10, 11
5	Illumination requirements: Schedule 17, item 4

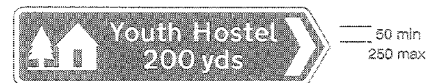

2304

Direction and distance to a hostel as defined in the caption under diagram 2303

Item	
1	Regulations: None
2	Directions: 12(3)
3	Diagrams: None
4	Permitted variants: Schedule 16, items 6, 9, 15, 29
5	Illumination requirements: Schedule 17, item 4



**Status:** This is the original version (as it was originally made). This item of legislation is currently only available in its original format.

SCHEDULE 7 PART IV SERVICES SIGNS (contd.)

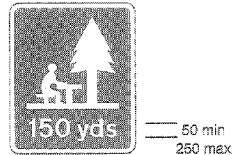

2305  
Distance ahead to a picnic area

Item	
1	Regulations: None
2	Directions: 12(3)
3	Diagrams: None
4	Permitted variants: Schedule 16, items 6, 10, 11
5	Illumination requirements: Schedule 17, item 4

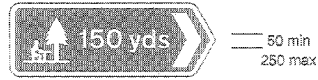

2306  
Direction and distance to a picnic area

Item	
1	Regulations: None
2	Directions: 12(3)
3	Diagrams: None
4	Permitted variants: Schedule 16, items 6, 9, 15, 29
5	Illumination requirements: Schedule 17, item 4

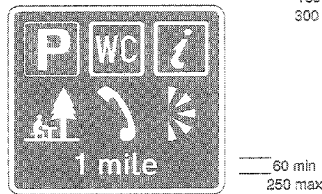

2307  
Distance ahead to a parking place with public toilets, Tourist Information Point or Centre, picnic site, public telephone and viewpoint

Item	
1	Regulations: None
2	Directions: 12(3)
3	Diagrams: None
4	Permitted variants: Schedule 16, items 6, 10 The AA or RAC logo may be added alongside the telephone symbol. Any of the symbols except the "P" and the "I" may be omitted. The name of a geographical area may be added at the top.
5	Illumination requirements: Schedule 17, item 4

150 min  
300 max



2308  
Junction ahead leading to a small town or village not on a main through route, which provides parking, public toilets, refreshments and fuel during normal shop opening hours at least

Item	
1	Regulations: None
2	Directions: 12(3)
3	Diagrams: None
4	Permitted variants: Schedule 16, items 12, 19 The spoon and fork (denoting restaurant), bed (denoting hotel) or tourist information "I" symbols shall be omitted where those facilities are not provided. A white pump symbol shall be substituted for the one shown where unleaded petrol is not available. In Wales the words "local services" may be omitted.
5	Illumination requirements: Schedule 17, item 4

Status: This is the original version (as it was originally made). This item of legislation is currently only available in its original format.

SCHEDULE 7 PART IV SERVICES SIGNS (contd.)



125 min  
250 max

2309

Direction and distance to a small town or village offering the services indicated on the sign in diagram 2308

Item	
1	Regulations: None
2	Directions: 12(3)
3	Diagrams: None
4	Permitted variants: Schedule 16, items 5, 8, 15, 19 Place name may be omitted
5	Illumination requirements: Schedule 17, item 4

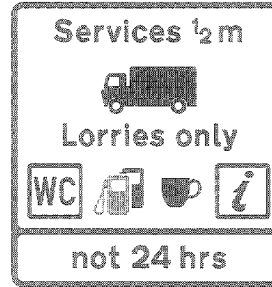

100 min  
300 max

2310

Distance ahead to services on a non-primary route at which fuel, parking, refreshments, telephones and toilets are available for goods vehicles at least between 8 am and 8 pm on every day except Christmas Day, Boxing Day and New Year's Day

Item	
1	Regulations: None
2	Directions: 12(1)
3	Diagrams: None
4	Permitted variants: Schedule 16, item 7 The spoon and fork symbol (denoting restaurant) may be substituted for the cup symbol. The bed symbol (denoting hotel) and wheelchair symbol (denoting disabled facilities) may be added. The tourist information "i" symbol shall be omitted where this facility is not provided. The lorry symbol and the words "Lorries only" shall be omitted where facilities are provided for all classes of traffic. The lorry symbol with the red bar shown in diagram 2311 shall be substituted for the lorry symbol shown and the words "Lorries only" omitted where there are no facilities for goods vehicles. The phrase "not 24 hrs" shall be omitted when the facilities are available at all times except Christmas Day, Boxing Day and New Year's Day
5	Illumination requirements: Schedule 17, item 4

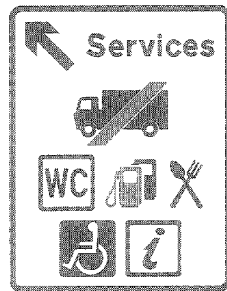

100 min  
300 max

2311

Direction to services on a non-primary route at which fuel, parking, refreshments, telephones and toilets are available for vehicles other than goods vehicles at all times except Christmas Day, Boxing Day and New Year's Day

Item	
1	Regulations: None
2	Directions: 12(1)
3	Diagrams: None
4	Permitted variants: Schedule 16, item 12 The lorry symbol with the red bar shall be omitted where facilities are provided for all classes of traffic. The lorry symbol shown in diagram 2310 and the words "Lorries only" shall be substituted for the lorry symbol with the red bar where the facilities provided are primarily for heavy goods vehicles. The cup symbol (denoting light refreshments) may be substituted for the spoon and fork symbol. The wheelchair and tourist "i" symbol shall be omitted where these facilities are not provided. The bed symbol (denoting hotel) may be added. The phrase "not 24 hrs" shall be added in a panel at the bottom of the sign as shown in diagram 2310 where the facilities are available between at least 8 am and 8 pm
5	Illumination requirements: Schedule 17, item 4



75 min  
300 max

2312

Entrance to services indicated by a sign shown in diagram 2310 or 2311

Item	
1	Regulations: None
2	Directions: 12(1)
3	Diagrams: None
4	Permitted variants: Schedule 18, item 15
5	Illumination requirements: Schedule 17, item 4

**Status:** This is the original version (as it was originally made). This item of legislation is currently only available in its original format.

SCHEDULE 7 PART IV SERVICES SIGNS (contd.)



2312.1  
Same as diagram 2312

Item	
1	Regulations: None
2	Directions: 12(1)
3	Diagrams: None
4	Permitted variants: Schedule 16, item 12
5	Illumination requirements: Schedule 17, item 4

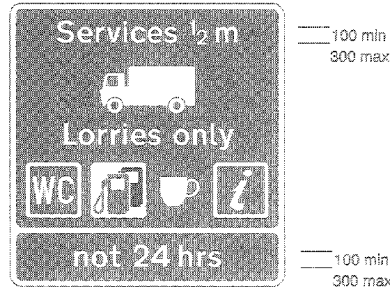

2313  
Distance ahead to services on a primary route at which fuel, parking, refreshments, telephones and toilets are available at least between 8 am and 8 pm on every day except Christmas Day, Boxing Day and New Year's Day

Item	
1	Regulations: None
2	Directions: 11(1)
3	Diagrams: None
4	Permitted variants: Schedule 16, item 7 Same as diagram 2310
5	Illumination requirements: Schedule 17, item 4

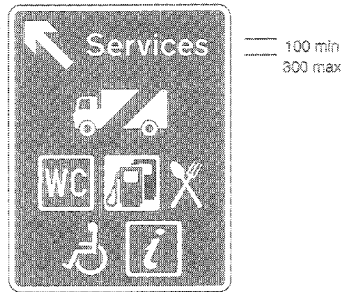

2314  
Direction to services on a primary route at which fuel, parking, refreshments, telephones and toilets are available for vehicles other than goods vehicles at all times on every day except Christmas Day, Boxing Day and New Year's Day

Item	
1	Regulations: None
2	Directions: 11(1)
3	Diagrams: None
4	Permitted variants: Schedule 16, item 12 Same as diagram 2311
5	Illumination requirements: Schedule 17, item 4



2315  
Entrance to services indicated by a sign shown in diagram 2313 or 2314

Item	
1	Regulations: None
2	Directions: 11(1)
3	Diagrams: None
4	Permitted variants: Schedule 16, item 15
5	Illumination requirements: Schedule 17, item 4

**Status:** This is the original version (as it was originally made). This item of legislation is currently only available in its original format.

SCHEDULE 7 PART IV SERVICES SIGNS (contd.)



75 min  
300 max

2315.1  
Same as diagram 2315

Item	
1	Regulations: None
2	Directions: 11(1)
3	Diagrams: None
4	Permitted variants: Schedule 16, item 12
5	Illumination requirements: Schedule 17, item 4



50 min  
250 max

2318  
Junction ahead leading to an Automobile Association service centre

Item	
1	Regulations: None
2	Directions: 12(3)
3	Diagrams: None
4	Permitted variants: Schedule 16, items 6, 9, 13, 14, 28 The word "Service" may be omitted
5	Illumination requirements: Schedule 17, item 9



50 min  
250 max

2317  
Direction and distance to an Automobile Association service centre

Item	
1	Regulations: None
2	Directions: 12(3)
3	Diagrams: None
4	Permitted variants: Schedule 16, items 6, 9, 15, 28, 29
5	Illumination requirements: Schedule 17, item 9



50 min  
250 max

2318  
Direction and distance to an Automobile Association telephone

Item	
1	Regulations: None
2	Directions: 12(3)
3	Diagrams: None
4	Permitted variants: Schedule 16, items 6, 9, 15, 28, 29
5	Illumination requirements: Schedule 17, item 9

**Status:** This is the original version (as it was originally made). This item of legislation is currently only available in its original format.

SCHEDULE 7 PART IV SERVICES SIGNS (contd.)



50 min  
250 max

2319  
Distance ahead to a Royal Automobile Club service centre

Item	
1	Regulations: None
2	Directions: 12(3)
3	Diagrams: None
4	Permitted variants: Schedule 16, items 6, 9, 10, 11, 26 The words "Service Centre" may be omitted
5	Illumination requirements: Schedule 17, item 9



50 min  
250 max

2320  
Direction and distance to a Royal Automobile Club service centre

Item	
1	Regulations: None
2	Directions: 12(3)
3	Diagrams: None
4	Permitted variants: Schedule 16, items 8, 9, 15, 26, 29
5	Illumination requirements: Schedule 17, item 9

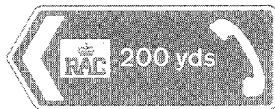

50 min  
250 max

2321  
Direction and distance to a Royal Automobile Club telephone

Item	
1	Regulations: None
2	Directions: 12(3)
3	Diagrams: None
4	Permitted variants: Schedule 16, items 6, 9, 15, 26, 29
5	Illumination requirements: Schedule 17, item 9



50 min  
250 max

2322  
Direction to a public telephone

Item	
1	Regulations: None
2	Directions: 12(2)
3	Diagrams: None
4	Permitted variants: Schedule 16, items 3, 6, 15, 28, 29 "Payphone" may be omitted or varied to "Carphone"
5	Illumination requirements: Schedule 17, item 9

**Status:** This is the original version (as it was originally made). This item of legislation is currently only available in its original format.

SCHEDULE 7 PART IV SERVICES SIGNS (contd.)



2323  
Direction to public toilets with facilities  
for disabled people

Item	
1	Regulations: None
2	Directions: 12(2)
3	Diagrams: None
4	Permitted variants: Schedule 16, items 2, 6, 15, 22 The wheelchair symbol may be omitted. The words "Ladies" or "Gents" may be added
5	Illumination requirements: Schedule 17, item 3

**Status:** This is the original version (as it was originally made). This item of legislation is currently only available in its original format.

**PART V**  
**BOUNDARY SIGNS**  
**(other than on motorways)**

SCHEDULE 7 PART V  
BOUNDARY SIGNS  
(other than on motorways)

Regulation 11(1)

70 min  
280 max



2401  
County or (in Scotland) regional boundary

Item	
1	Regulations: 10(1), 10(4)
2	Directions: 12(3)
3	Diagrams: None
4	Permitted variants: Schedule 16, item 19 The crest or logo may be omitted or varied as appropriate. The name of the county may be varied to "England", "Scotland" or "Wales". A message of welcome, or a phrase denoting an item of local geographical or historical interest, not exceeding 4 words may be added. The letters, border and background may be in any contrasting colours except red. The border may be omitted. In Scotland a reference to not more than two places outside the United Kingdom with which the Scottish local authority is twinned may be added as shown in diagram 2400
5	Illumination requirements: Schedule 17, item 9

**Status:** This is the original version (as it was originally made). This item of legislation is currently only available in its original format.

SCHEDULE 7 PART V BOUNDARY SIGNS (contd.)

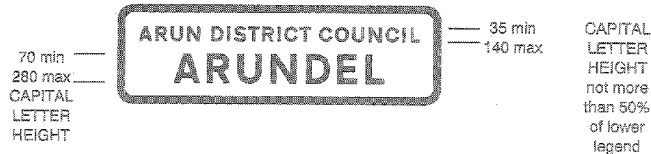

2402  
Name of a town or village commencing immediately ahead

Item	
1	Regulations: 13(1), 13(4)
2	Directions: 12(3)
3	Diagrams: None
4	Permitted variants: Schedules 16, item 19 The place name may be varied to the name of a river, inland waterway, bridge, tunnel, or road junction. A crest or logo may be added when the sign indicates the name of a place. The District Council name may be varied to that of a London Borough or omitted. The District Council name shall be omitted when the sign is varied to indicate a name other than that of a place. The name of a District Council or London Borough shall not be used without the place name. The letters, border and background may be in any contrasting colours except red. The border may be omitted
5	Illumination requirements: Schedule 17, item 9

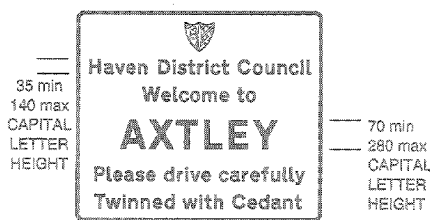

2403  
Name of a town or village commencing immediately ahead, together with extra local information and a road safety message

Item	
1	Regulations: 13(1), 13(4)
2	Directions: 12(3)
3	Diagrams: None
4	Permitted variants: Schedule 16, item 19 The crest may be omitted, varied as appropriate, or varied to a logo or pictorial representation of a local landmark or historical feature. "Welcome to" may be omitted. "Please drive carefully" may be omitted or varied to another road safety message, or phrase denoting an item of local geographical or historical interest, not exceeding 4 words. "Twinned with" may be varied to "Twin town" or "Twin towns". The name of the twin town shall be varied as appropriate. The name of a second twin town may be added. The reference to twin towns may be omitted. The letters, border and background may be in any contrasting colour except red. The border may be omitted
5	Illumination requirements: Schedule 17, item 9



**Status:** This is the original version (as it was originally made). This item of legislation is currently only available in its original format.

## PART VI

### DIRECTIONAL SIGNS TO PARKING PLACES

#### SCHEDULE 7 PART VI DIRECTIONAL SIGNS TO PARKING PLACES

Regulation 11(1)

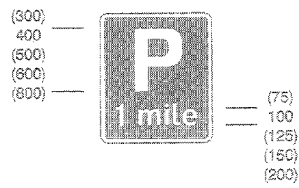

**2501**  
Distance to a parking place ahead

Item	
1	Regulations: None
2	Directions: 12(3)
3	Diagrams: None
4	Permitted variants: Schedule 16, items 8, 9, 10
5	Illumination requirements: Schedule 17, item 4

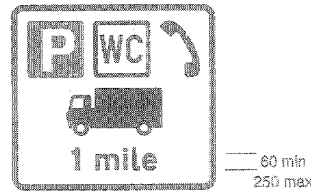

**2502**  
Distance to a commercial vehicles parking place ahead with public toilets and telephones

Item	
1	Regulations: None
2	Directions: 12(3)
3	Diagrams: None
4	Permitted variants: Schedule 16, items 8, 10 The 'WC' or 'WC' or telephone symbol may be omitted. The AA or RAC logos may be added alongside the telephone symbol.
5	Illumination requirements: Schedule 17, item 4

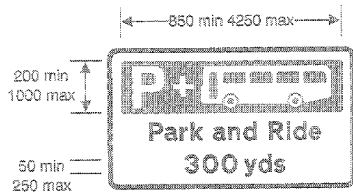

**2503**  
Distance to a parking place ahead from which a 'Park and Ride' scheme operates

Item	
1	Regulations: None
2	Directions: 12(3)
3	Diagrams: None
4	Permitted variants: Schedule 16, items 6, 10, 11, 28 The days of operation may be added. The bus symbol may be varied to the tram symbol shown in diagram 953.1 or the British Rail or London Transport symbol or a PTE symbol
5	Illumination requirements: Schedule 17, item 4

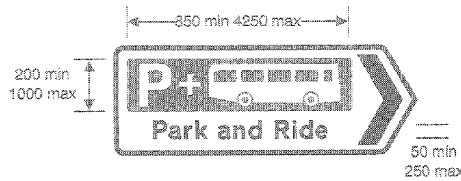

**2504**  
Direction to a parking place from which a 'Park and Ride' scheme operates

Item	
1	Regulations: None
2	Directions: 12(3)
3	Diagrams: None
4	Permitted variants: Schedule 16, items 3, 6, 15, 28 Same as diagram 2503
5	Illumination requirements: Schedule 17, item 4

**Status:** This is the original version (as it was originally made). This item of legislation is currently only available in its original format.

SCHEDULE 7 PART VI DIRECTIONAL SIGNS TO PARKING PLACES (contd.)

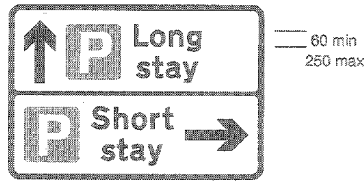

2505  
Directions to different types of parking place from a junction ahead

Item	
1	Regulations: None
2	Directions: 12(3)
3	Diagrams: None
4	Permitted variants: Schedule 16, items 3, 6, 12, 18, 28, 38 One of the following alternative legends may be used or the legend may be omitted: 1. "Free" 2. "Shoppers" 3. "Commuters" 4. "Long stay" 5. "Short stay" 6. "Pay and display" 7. "Multi-storey" 8. A geographical name 9. British Rail, London Transport or a PTE symbol Any one or two of the following symbols may be added: 1. Pedal cycle shown in diagram 968 2. Bus shown in diagram 969 3. Goods vehicle shown in diagram 804.1 4. Car shown in diagram 804.2 5. Caravan drawn by car shown in diagram 804.3 6. Tourist information "i" shown in diagram 2310 The total number of spaces in the parking place may be indicated in white figures in the bottom right hand corner of the "P" symbol as shown in diagram 2506
5	Illumination requirements: Schedule 17, item 4



2506  
Direction to a parking place for shoppers and showing the total number of parking places

Item	
1	Regulations: None
2	Directions: 12(3)
3	Diagrams: None
4	Permitted variants: Schedule 16, items 3, 6, 12, 28, 38 The number of spaces may be varied or omitted. Same as diagram 2505
5	Illumination requirements: Schedule 17, item 4



2507  
Direction to a parking place available only on the day specified

Item	
1	Regulations: None
2	Directions: 12(3)
3	Diagrams: None
4	Permitted variants: Schedule 16, items 3, 6, 15, 28, 37, 38 Same as diagram 2505
5	Illumination requirements: Schedule 17, item 4

**Status:** This is the original version (as it was originally made). This item of legislation is currently only available in its original format.

SCHEDULE 7 PART VI DIRECTIONAL SIGNS TO PARKING PLACES (contd.)

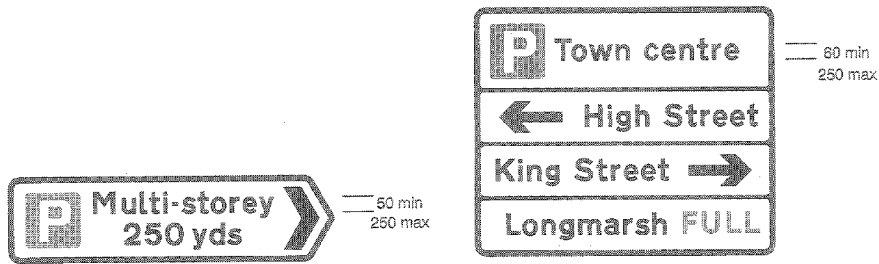

2508  
Direction and distance to a multi-storey parking place

Item	
1	Regulations: None
2	Directions: 12(3)
3	Diagrams: None
4	Permitted variants: Schedule 16, items 6, 9, 15, 28, 38 Same as diagram: 2505
5	Illumination requirements: Schedule 17, item 4

2509  
Directions to several alternative parking places with an indication of the availability of parking spaces at each one

Item	
1	Regulations: None
2	Directions: 12(3), 49
3	Diagrams: None
4	Permitted variants: Schedule 16, items 12, 16, 19 The name of a place may be added to or substituted for the words "Town centre". The legends "Long stay" or "Short stay" may be added to or substituted for each of the geographical names. The word "FULL" may be varied to "CLOSED" in red letters. The arrow symbols may remain displayed when the legends "FULL" or "CLOSED" are shown. The word "Spaces" in black or green letters or "Nearly full" in black letters may be displayed in addition to the arrow symbols
5	Illumination requirements: Schedule 17, item 4

**Status:** This is the original version (as it was originally made). This item of legislation is currently only available in its original format.

## PART VII

### DIRECTIONAL SIGNS FOR CYCLISTS AND PEDESTRIANS

#### SCHEDULE 7 PART VII DIRECTIONAL SIGNS FOR CYCLISTS AND PEDESTRIANS

Regulation 11(1)

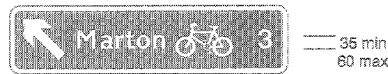

**2601**  
Junction ahead where route to destination shown recommended for pedal cycles differs from that for other traffic

Item	
1	Regulations: None
2	Directions: 12(3)
3	Diagrams: None
4	Permitted variants: Schedule 16, items 5, 9, 12, 19, 28, 29, 34
5	Illumination requirements: Schedule 17, item 9

**2602**  
Direction and distance to destination shown of route recommended for pedal cycles, which differs from that for other traffic

Item	
1	Regulations: None
2	Directions: 12(3)
3	Diagrams: None
4	Permitted variants: Schedule 16, items 5, 9, 15, 19, 28, 29, 34
5	Illumination requirements: Schedule 17, item 9

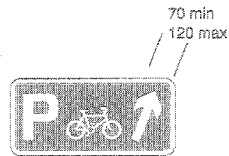

**2603**  
Junction ahead leading to a parking place for pedal cycles

Item	
1	Regulations: None
2	Directions: 12(3)
3	Diagrams: None
4	Permitted variants: Schedule 16, items 3, 6, 12, 28, 29
5	Illumination requirements: Schedule 17, item 9



**2604**  
Direction and distance to a free parking place for pedal cycles

Item	
1	Regulations: None
2	Directions: 12(3)
3	Diagrams: None
4	Permitted variants: Schedule 16, items 6, 9, 15, 28, 29 The word "Free" may be omitted.
5	Illumination requirements: Schedule 17, item 9

**Status:** This is the original version (as it was originally made). This item of legislation is currently only available in its original format.

SCHEDULE 7 PART VII DIRECTIONAL SIGNS FOR CYCLISTS AND PEDESTRIANS (cont'd.)



2605  
Direction of route to destination shown for pedestrians

Item	
1	Regulations: None
2	Directions: 12(3)
3	Diagrams: None
4	Permitted variants: Schedule 16, items 3, 6, 15, 19, 28, 29, 30, 34
5	Illumination requirements: Schedule 17, item 9

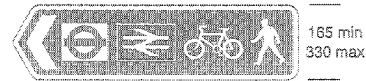

2606  
Direction of route to railway station for pedestrians and pedal cycles

Item	
1	Regulations: None
2	Directions: 12(3)
3	Diagrams: None
4	Permitted variants: Schedule 16, items 3, 6, 15, 28, 29 The British Rail or London Transport symbols may be omitted or varied to the symbol of a PTE. The British Rail symbol may be used with a PTE symbol. The cycle or pedestrian symbol, but not both may be omitted.
5	Illumination requirements: Schedule 17, item 9



2607  
Same as diagram 2605

Item	
1	Regulations: 13(1), 13(4)
2	Directions: 12(3)
3	Diagrams: None
4	Permitted variants: Schedule 16, items 3, 6, 15, 19, 24, 28, 29, 34 A border and chevron may be added, the colours may be varied to: 1. White on a blue background 2. White on a green background 3. Gold on a black background 4. White on a brown background where the sign indicates the direction to a tourist attraction.
5	Illumination requirements: Schedule 17, item 9



2608  
Direction of route to a tourist attraction for pedestrians

Item	
1	Regulations: None
2	Directions: 12(3)
3	Diagrams: None
4	Permitted variants: Schedule 16, items 3, 6, 15, 19, 28, 29, 33
5	Illumination requirements: Schedule 17, item 9

Status: This is the original version (as it was originally made). This item of legislation is currently only available in its original format.

SCHEDULE 7 PART VII DIRECTIONAL SIGNS FOR CYCLISTS AND PEDESTRIANS (contd.)



2603  
Direction of route for pedestrians to a parking place associated with a tourist attraction

Item
1 Regulations: None
2 Directions: 12(3)
3 Diagrams: None
4 Permitted variants: Schedule 16, items 3, 6, 15, 26, 29
5 Illumination requirements: Schedule 17, item 9

2810  
Direction to or along a public footpath or bridleway

Item
1 Regulations: 13(1), 13(4)
2 Directions: 12(3), 36, 37
3 Diagrams: None
4 Permitted variants: Schedule 16, items 3, 6, 15, 26, 29 The border and chevron may be omitted. The background, border, symbol and lettering may be any contrasting colours except red. The walking figure symbol may be omitted or varied to the ridden horse shown in diagram S22.6 or other appropriate symbol. The word "Public" may be omitted. The word "Footpath" may be varied to "Bridleway". The name of the route or destination may be added to or substituted for the legend "Public Footpath". An indication that a footpath over a railway level crossing is closed and of the direction of the alternative route may be added.
5 Illumination requirements: Schedule 17, item 9

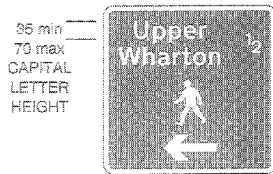

2610.1  
Same as diagram 2610

Item
1 Regulations: 13(1), 13(4)
2 Directions: 12(3), 36, 37
3 Diagrams: None
4 Permitted variants: Schedule 16, items 3, 6, 9, 10, 19, 26 The border may be omitted. The background, border, symbol and lettering may be any contrasting colours except red. The walking figure symbol may be omitted or varied to the ridden horse shown in diagram S22.6 or other appropriate symbol. The name of the destination may be varied to the name of the route or omitted. The words "Public Footpath", "Footpath" or "Bridleway" may be added to or substituted for the destination. An indication that a footpath over a level crossing is closed and the direction of the alternative route may be added.
5 Illumination requirements: Schedule 17, item 9

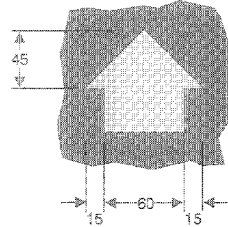

2610.2  
Direction along a footpath, bridleway or byway indicated by waymarks

Item
1 Regulations: 13(1), 13(4)
2 Directions: 12(3), 36, 37
3 Diagrams: None
4 Permitted variants: Schedule 16, items 3, 6, 12 The colour of the arrow may be varied to blue to indicate bridleways, or red to indicate byways open to all traffic. The name of a destination or route or the identifying symbol of a route may be added on or adjacent to the arrow. The background and any lettering may be any contrasting colours except red or yellow.
5 Illumination requirements: Schedule 17, item 9

**Status:** This is the original version (as it was originally made). This item of legislation is currently only available in its original format.

## PART VIII TEMPORARY AND EMERGENCY DIRECTIONAL SIGNS

### SCHEDULE 7 PART VIII TEMPORARY AND EMERGENCY DIRECTIONAL SIGNS

Regulation 11(1)



2701  
Direction to a new housing development

Item	
1	Regulations: None
2	Directions: 12(3), 33(2)
3	Diagrams: None
4	Permitted variants: Schedule 16, items 3, 8, 15, 19, 29 The lorry symbol in diagram 804.1 may be added
5	Illumination requirements: Schedule 17, item 6

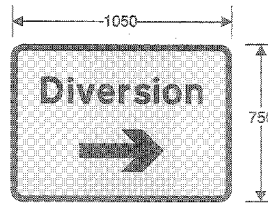

2702  
Start of temporary diversion route

Item	
1	Regulations: None
2	Directions: 12(3)
3	Diagrams: None
4	Permitted variants: Schedule 16, item 12 The arrow symbol may be replaced by the word 'ends' or a distance in yards up to 400 yards to the nearest 10 yards.
5	Illumination requirements: Schedule 17, item 4



2703  
Direction of temporary diversion route from junction ahead

Item	
1	Regulations: None
2	Directions: 12(3)
3	Diagrams: None
4	Permitted variants: Schedule 16, item 12 Route number may be added. Any symbol shown in Part VII of Schedule 13 may be substituted for "Diverted traffic".
5	Illumination requirements: Schedule 17, item 4



2704  
Direction of temporary diversion route

Item	
1	Regulations: None
2	Directions: 12(3)
3	Diagrams: None
4	Permitted variants: Schedule 16, item 15 Same as diagram 2703
5	Illumination requirements: Schedule 17, item 4

**Status:** This is the original version (as it was originally made). This item of legislation is currently only available in its original format.

SCHEDULE 7 PART VIII TEMPORARY AND EMERGENCY DIRECTIONAL SIGNS (contd.)

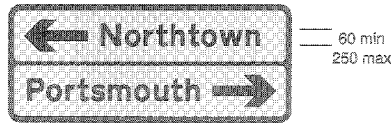

2705  
Junction ahead leading to temporary diversion routes to the destinations shown

Item	
1	Regulations: None
2	Directions: 12(3)
3	Diagrams: None
4	Permitted variants: Schedule 16, items 3, 5, 12, 16, 19, 20, 30
5	Illumination requirements: Schedule 17, item 4

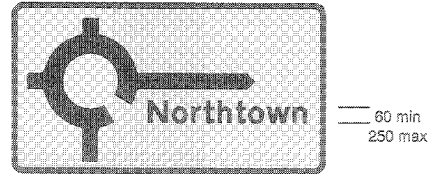

2708  
Roundabout ahead leading to a temporary diversion route to the destination shown

Item	
1	Regulations: None
2	Directions: 12(3)
3	Diagrams: None
4	Permitted variants: Schedule 16, items 3, 5, 16, 19, 20, 30
5	Illumination requirements: Schedule 17, item 4



2707  
Direction of temporary diversion route to destination shown

Item	
1	Regulations: None
2	Directions: 12(3)
3	Diagrams: None
4	Permitted variants: Schedule 16, items 3, 5, 16, 19, 20, 30
5	Illumination requirements: Schedule 17, item 4



2708  
Junction ahead leading to route for emergency vehicles to a temporary incident control point

Item	
1	Regulations: 12(6)
2	Directions: 12(3)
3	Diagrams: None
4	Permitted variants: Schedule 16, item 12 "EMERGENCY VEHICLES" may be varied to "INCIDENT CONTROL"
5	Illumination requirements: Schedule 17, item 4



**Status:** This is the original version (as it was originally made). This item of legislation is currently only available in its original format.

SCHEDULE 7 PART VIII TEMPORARY AND EMERGENCY DIRECTIONAL SIGNS (contd.)

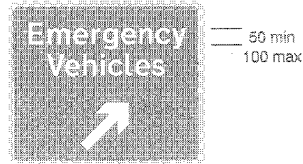

2709  
Direction of route for emergency vehicles to an emergency services incident point

Item	
1	Regulations: None
2	Directions: 12(3)
3	Diagrams: None
4	Permitted variants: Schedule 16, Item 12 Place name may be added
5	Illumination requirements: Schedule 17, Item 4



2710  
Direction of route for emergency vehicles to an emergency services incident point

Item	
1	Regulations: None
2	Directions: 12(3)
3	Diagrams: None
4	Permitted variants: Schedule 16, Item 13 Place name may be added
5	Illumination requirements: Schedule 17, Item 4

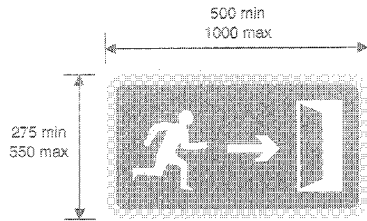

2711  
Direction to emergency exit for pedestrians from a tunnel

Item	
1	Regulations: 12(6)
2	Directions: None
3	Diagrams: None
4	Permitted variants: Schedule 16, Items 13, 28 Symbols may be arranged vertically
5	Illumination requirements: Schedule 17, Item 2

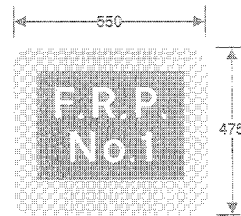

2712  
Location of fire rendezvous point

Item	
1	Regulations: 12(6)
2	Directions: 12(3)
3	Diagrams: None
4	Permitted variants: The legend "No. 1" may be varied to another number, a letter or a compass point. "F.R.P." may be varied to "R.V.P."
5	Illumination requirements: Schedule 17, Item 9

**Status:** This is the original version (as it was originally made). This item of legislation is currently only available in its original format.

SCHEDULE 7 PART VIII TEMPORARY AND EMERGENCY DIRECTIONAL SIGNS (contd.)

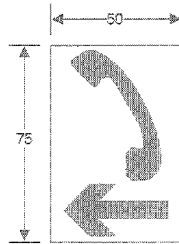

2713  
Direction to nearest emergency telephone box on same side of the road

Item	
1	Regulations: 12(8)
2	Directions: None
3	Diagrams: None
4	Permitted variants: Schedule 16, item 15
5	Illumination requirements: Schedule 17, item 5

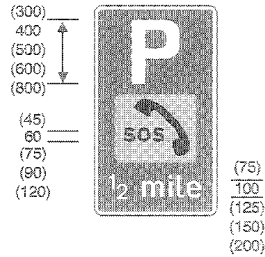

2713.1  
Distance ahead to emergency telephone in a lay-by

Item	
1	Regulations: None
2	Directions: 12(3)
3	Diagrams: 642.2, 1018.1
4	Permitted variants: Schedule 16, items 6, 9, 11, 28 The 'P' symbol may be placed to the left of the orange panel or omitted
5	Illumination requirements: Schedule 17, item 4

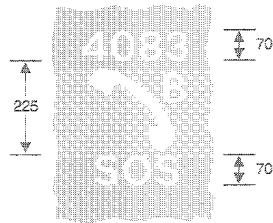

2714  
Side of emergency telephone box

Item	
1	Regulations: 12(6), 19(4)
2	Directions: None
3	Diagrams: None
4	Permitted variants: The identification number may be varied as appropriate. The colour of the legend and symbol may be varied to black
5	Illumination requirements: Schedule 17, item 15

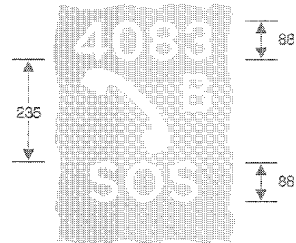

2715  
Back of emergency telephone box

Item	
1	Regulations: 12(6), 19(4)
2	Directions: None
3	Diagrams: None
4	Permitted variants: Same as diagram 2714
5	Illumination requirements: Schedule 17, item 15

**Status:** This is the original version (as it was originally made). This item of legislation is currently only available in its original format.

SCHEDULE 7 PART VIII TEMPORARY AND EMERGENCY DIRECTIONAL SIGNS (contd.)



2716

Junction ahead leading to a temporary diversion route, the direction along which is indicated by a symbol shown in Part VII of Schedule 13

Item	
1	Regulations: None
2	Directions: None
3	Diagrams: None
4	Permitted variants: Schedule 16, Item 20 The diversion symbol may be varied to any of those shown in Part VII of Schedule 13 or to a route number or numbers in which case the legend may be on an extra line; "follow" may be omitted when route numbers are shown
5	Illumination requirements: Schedule 17, Item 4

**Status:** This is the original version (as it was originally made). This item of legislation is currently only available in its original format.

## PART IX

### OTHER NON-MOTORWAY DIRECTIONAL SIGNS

#### SCHEDULE 7 PART IX OTHER NON-MOTORWAY DIRECTIONAL SIGNS

Regulation 11(1)

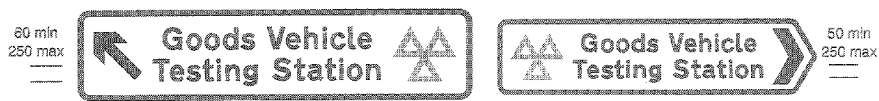

2801  
Junction ahead leading to Department of Transport testing station for goods vehicles

Item	
1	Regulations: None
2	Directions: 12(3)
3	Diagrams: None
4	Permitted variants: Schedule 16, items 3, 6, 12, 29
5	Illumination requirements: Schedule 17, item 9

2802  
Direction to Department of Transport testing station for goods vehicles

Item	
1	Regulations: None
2	Directions: 12(3)
3	Diagrams: None
4	Permitted variants: Schedule 16, items 3, 6, 15, 29
5	Illumination requirements: Schedule 17, item 9

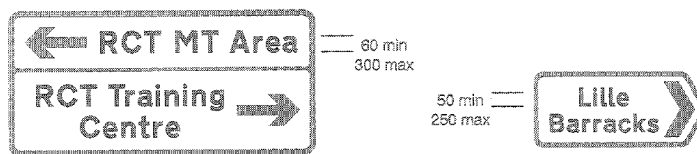

2803  
Junction ahead leading to routes to Ministry of Defence establishments

Item	
1	Regulations: None
2	Directions: 12(3)
3	Diagrams: None
4	Permitted variants: Schedule 16, items 3, 5, 12, 16, 19
5	Illumination requirements: Schedule 17, item 4

2804  
Direction to a Ministry of Defence establishment

Item	
1	Regulations: None
2	Directions: 12(3)
3	Diagrams: None
4	Permitted variants: Schedule 16, items 3, 5, 15, 19
5	Illumination requirements: Schedule 17, item 4

**Status:** This is the original version (as it was originally made). This item of legislation is currently only available in its original format.

SCHEDULE 7 PART IX OTHER NON-MOTORWAY DIRECTIONAL SIGNS (contd.)

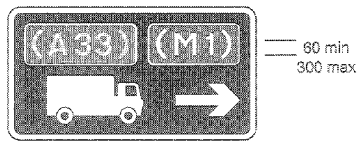

2805  
Junction ahead leading to route advised for goods vehicles, which differs from that for other traffic

Item	
1	Regulations: None
2	Directions: 12(3)
3	Diagrams: None
4	Permitted variants: Schedule 16, items 12, 18, 20, 21, 22, 28 Destinations may be added to or substituted for the route numbers. Non-primary route numbers shall be shown in white characters on the black background.
5	Illumination requirements: Schedule 17, item 4

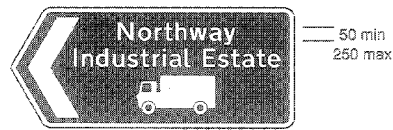

2806  
Direction to destination shown of route advised for goods vehicles, which differs from that for other traffic

Item	
1	Regulations: None
2	Directions: 12(5)
3	Diagrams: None
4	Permitted variants: Schedule 16, items 15, 19, 20, 21, 22, 28 Route numbers may be added to or substituted for the destination. Non-primary route numbers shall be shown in white characters on the black background.
5	Illumination requirements: Schedule 17, item 4



2807  
Direction to destination shown along minor rural roads

Item	
1	Regulations: None
2	Directions: 12(2)
3	Diagrams: None
4	Permitted variants: Schedule 16, items 3, 5, 15, 19
5	Illumination requirements: Schedule 17, item 9

**Status:** This is the original version (as it was originally made). This item of legislation is currently only available in its original format.

## PART X MOTORWAY SIGNS

### SCHEDULE 7 PART X MOTORWAY SIGNS

Regulation 11(1)



2901  
Regulations in force under section 17 of the 1984 Act start to apply to the road at this point

Item	
1	Regulations: None
2	Directions: 13(1)
3	Diagrams: None
4	Permitted variants: Schedule 16, item 20
5	Illumination requirements: Schedule 17, item 1

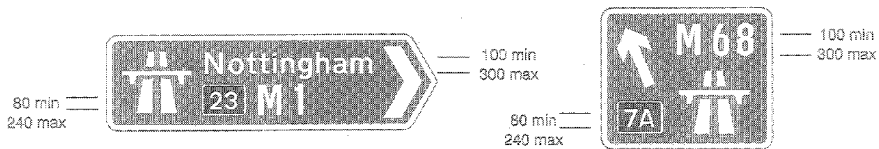

2902  
Direction to a motorway at the junction shown, indicating route number and destination reached along the motorway

Item	
1	Regulations: None
2	Directions: 13(2)
3	Diagrams: None
4	Permitted variants: Schedule 16, items 15, 19, 20, 28, 30 The motorway regulations symbol shall be omitted and the letters and numerals in Part 1 of Schedule 13 used for the motorway route number where that part of the junction leads indirectly to the motorway
5	Illumination requirements: Schedule 17, item 1

2902.1  
Direction to a motorway at the junction shown, indicating route number and destination

Item	
1	Regulations: None
2	Directions: 13(2)
3	Diagrams: None
4	Permitted variants: Schedule 16, items 12, 20, 29
5	Illumination requirements: Schedule 17, item 1

**Status:** This is the original version (as it was originally made). This item of legislation is currently only available in its original format.

SCHEDULE 7 PART X MOTORWAY SIGNS (contd.)

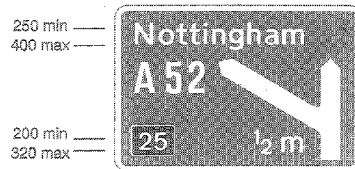

2903

Motorway junction ahead, identified by the number shown on a black background, leading to the destination and route shown. The number of lanes on the motorway remains the same through the junction

Item	
1	Regulations: None
2	Directions: 19(1)
3	Diagrams: None
4	Permitted variants: Schedule 16, items 7, 19, 20, 30, 34
5	Illumination requirements: Schedule 17, item 1

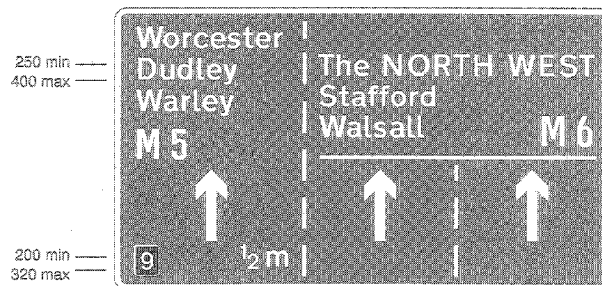

2904

Motorway junction ahead, identified by the number shown on a black background, where the left hand lane of a motorway leads to another motorway and the other two lanes continue along the main motorway route

Item	
1	Regulations: 13(2)
2	Directions: 19(1)
3	Diagrams: None
4	Permitted variants: Schedule 16, items 7, 19, 20, 30, 34
5	Illumination requirements: Schedule 17, item 1

**Status:** This is the original version (as it was originally made). This item of legislation is currently only available in its original format.

SCHEDULE 7 PART X MOTORWAY SIGNS (contd.)

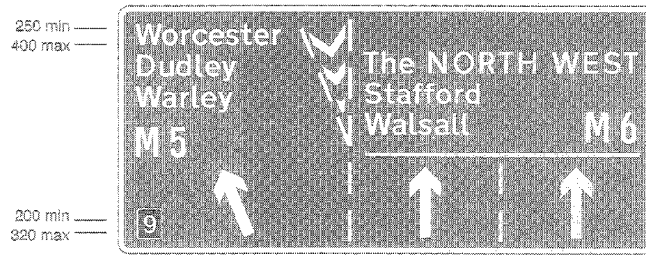

2904.1

Motorway junction identified by the number shown on a black background, where the left hand lane of a motorway leads to another motorway and the other two lanes continue along the main motorway route

Item	
1	Regulations: 13(2)
2	Directions: 13(1)
3	Diagrams: None
4	Permitted variants: Schedule 16, items 16, 19, 20, 30, 34
5	Illumination requirements: Schedule 17, item 1

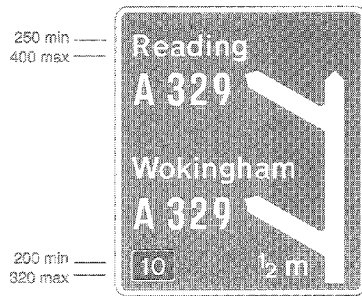

Item	
1	Regulations: 13(2)
2	Directions: 13(1)
3	Diagrams: None
4	Permitted variants: Schedule 16, items 7, 8, 19, 20, 30, 34
5	Illumination requirements: Schedule 17, item 1

2905

Two motorway junctions ahead in quick succession, identified by the number shown on a black background, leading to the destinations and routes shown. The number of lanes on the motorway remains the same through the junction



**Status:** This is the original version (as it was originally made). This item of legislation is currently only available in its original format.

SCHEDULE 7 PART X MOTORWAY SIGNS (contd.)

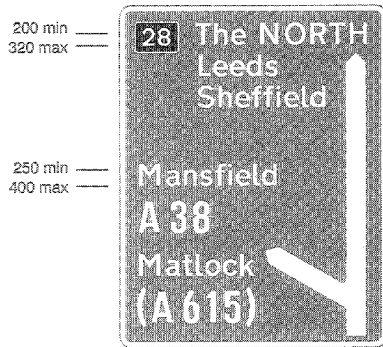

Item	
1	Regulations: 13(2)
2	Directions: 13(1)
3	Diagrams: None
4	Permitted variants: Schedule 16, items 19, 20, 30, 34
5	Illumination requirements: Schedule 17, item 1

2906  
Motorway junction, identified by the number shown on a black background, leading to the destination and route shown and with an indication of the destinations reached by remaining on the motorway. The number of lanes on the motorway remains the same through the junction.

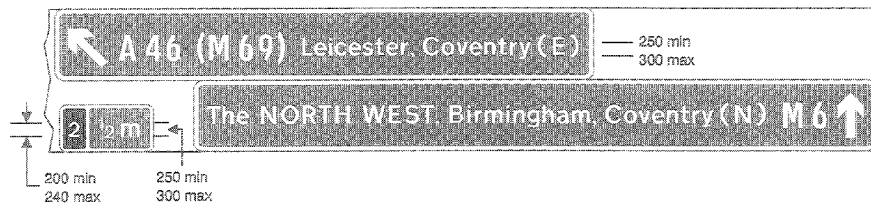

2908  
Motorway junction ahead, identified by the number shown on a black background, leading to the destinations and routes shown and with an indication of the destinations reached by remaining on the motorway. The number of lanes on the motorway remains the same through the junction

Item	
1	Regulations: 13(2)
2	Directions: 13(1)
3	Diagrams: None
4	Permitted variants: Schedule 16, items 7, 8, 19, 20, 30, 34
5	Illumination requirements: Schedule 17, item 1

**Status:** This is the original version (as it was originally made). This item of legislation is currently only available in its original format.

SCHEDULE 7 PART X MOTORWAY SIGNS (contd.)

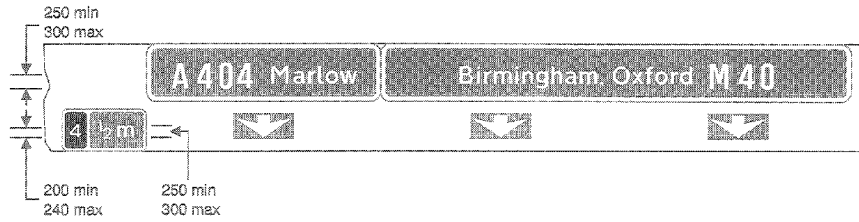

2809

Motorway junction ahead, identified by the number shown on a black background, where the left hand lane of a motorway leads to the route and destination shown and the other two lanes continue along the main motorway route to the destinations shown

Item	
1	Regulations: 13(2)
2	Directions: 13(1)
3	Diagrams: None
4	Permitted variants: Schedule 16, items 7, 8, 16, 19, 20, 30, 34
5	Illumination requirements: Schedule 17, item 1



— 200 min  
— 400 max



— 200 min  
— 400 max

2910

Number of route reached from a motorway exit road

2910.1

Same as diagram 2910

Item	
1	Regulations: None
2	Directions: 13(1)
3	Diagrams: None
4	Permitted variants: Schedule 16, item 20 The word "Services" may be added below the route number.
5	Illumination requirements: Schedule 17, item 1

Item	
1	Regulations: None
2	Directions: 13(1)
3	Diagrams: None
4	Permitted variants: Schedule 16, item 20 The word "Services" may be added below the route number.
5	Illumination requirements: Schedule 17, item 1

**Status:** This is the original version (as it was originally made). This item of legislation is currently only available in its original format.

SCHEDULE 7 PART X MOTORWAY SIGNS (contd.)

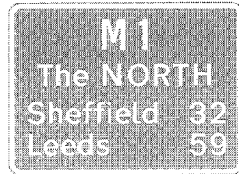

— 250 min  
— 400 max



— 250 min  
— 400 max

2911  
Route number of the motorway with destinations and distances to places along or reached from that route

2912  
Junction ahead with another motorway

Item	
1	Regulations: None
2	Directions: 13(1)
3	Diagrams: None
4	Permitted variants: Schedule 16, items 4, 19, 20, 30
5	Illumination requirements: Schedule 17, item 1

Item	
1	Regulations: None
2	Directions: 13(1)
3	Diagrams: None
4	Permitted variants: Schedule 16, items 4, 20
5	Illumination requirements: Schedule 17, item 1

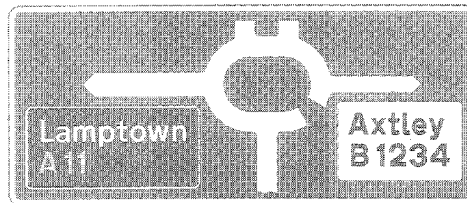

— 150 min  
— 300 max

2913  
Roundabout ahead leading from a motorway exit slip road to a primary and a non-primary route

Item	
1	Regulations: 13(2)
2	Directions: 13(1)
3	Diagrams: None
4	Permitted variants: Schedule 16, items 16, 18, 20, 21, 22, 23, 24, 25, 26, 30, 31, 32, 34
5	Illumination requirements: Schedule 17, item 4

**Status:** This is the original version (as it was originally made). This item of legislation is currently only available in its original format.

SCHEDULE 7 PART X MOTORWAY SIGNS (contd.)

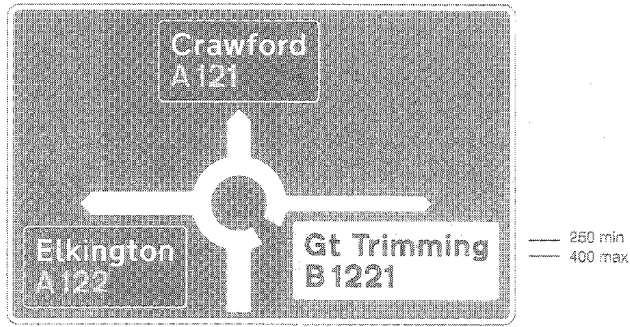

2914  
Termination of a motorway at a roundabout ahead leading to two primary routes and a non-primary route

Item	
1	Regulations: 13(2)
2	Directions: 13(1)
3	Diagrams: None
4	Permitted variants: Schedule 16, items 19, 16, 18, 20, 21, 22, 23, 24, 25, 26, 30, 31, 32, 34
5	Illumination requirements: Schedule 17, item 4



2915  
Motorway junction ahead indicating the route to be followed for destinations not otherwise signed at that junction

Item	
1	Regulations: None
2	Directions: 13(1)
3	Diagrams: None
4	Permitted variants: Schedule 16, items 19, 20, 30, 34 "follow" and the route may be varied to "leave at next junction" or "leave at junction" and the junction number; "Junction" may be varied to "J"
5	Illumination requirements: Schedule 17, item 1



2916  
Absence of hard shoulder for the distance shown

Item	
1	Regulations: None
2	Directions: 13(1)
3	Diagrams: None
4	Permitted variants: Schedule 16, items 6 Legend may be shown on four lines
5	Illumination requirements: Schedule 17, item 4

**Status:** This is the original version (as it was originally made). This item of legislation is currently only available in its original format.

SCHEDULE 7 PART X MOTORWAY SIGNS (contd.)



2917  
Availability of motorway service areas ahead with distances and names of operators

Item	
1	Regulations: None
2	Directions: 13(1)
3	Diagrams: None
4	Permitted variants: Schedule 16, items 4, 19, 20
5	Illumination requirements: Schedule 17, item 1



2918  
Distance to next motorway service area

Item	
1	Regulations: None
2	Directions: 13(1)
3	Diagrams: None
4	Permitted variants: Schedule 16, item 4, 20 Legend may be varied to "No services on motorway" or "No services on" and a motorway route number. When the sign is varied in either of these ways the sign may be placed on a road leading to the motorway.
5	Illumination requirements: Schedule 17, item 1

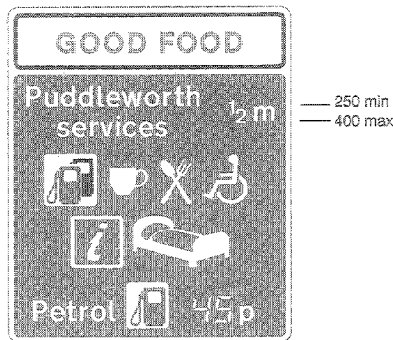

2919  
Distance ahead to a named motorway service area at which fuel, parking, toilets, telephones, refreshments, facilities for disabled people, overnight accommodation and a Tourist Information Point or Centre are available 24 hours a day throughout the year, and showing the name of the operator and the price per litre of unleaded petrol

Item	
1	Regulations: 13(1), 13(4)
2	Directions: 13(1)
3	Diagrams: None
4	Permitted variants: Schedule 16, item 8, 19 The name of the operator may be varied or omitted. Either or both of the second row of symbols may be omitted. The petrol price row may be omitted. The green pump symbol on a white panel may be replaced by a four star symbol. The price where shown shall accord with that currently being charged for 1 litre of unleaded or 4 star petrol as appropriate.
5	Illumination requirements: Schedule 17, item 1

**Status:** This is the original version (as it was originally made). This item of legislation is currently only available in its original format.

SCHEDULE 7 PART X MOTORWAY SIGNS (contd.)



2920  
Direction to a named motorway service area and showing the name of the operator

Item	
1	Regulations: 13(1), 13(4)
2	Directions: 13(1)
3	Diagrams: None
4	Permitted variants: Schedule 16, item 19 The name of the operator may be varied or omitted
5	Illumination requirements: Schedule 17, item 1



2921  
Entrance to motorway service area

Item	
1	Regulations: None
2	Directions: None
3	Diagrams: None
4	Permitted variants: Schedule 16, item 15
5	Illumination requirements: Schedule 17, item 1

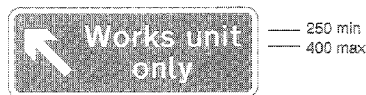

2922  
Entrance for works traffic only

Item	
1	Regulations: 12(8)
2	Directions: 13(1)
3	Diagrams: None
4	Permitted variants: None
5	Illumination requirements: Schedule 17, item 4

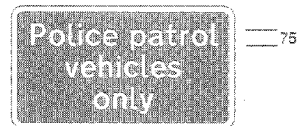

2923  
Waiting place for police vehicles only

Item	
1	Regulations: 12(8)
2	Directions: 13(1)
3	Diagrams: None
4	Permitted variants: None
5	Illumination requirements: Schedule 17, item 4

**Status:** This is the original version (as it was originally made). This item of legislation is currently only available in its original format.

SCHEDULE 7 PART X MOTORWAY SIGNS (contd.)



2924  
Motorway junction ahead leading to the tourist attractions shown

Item	
1	Regulations: None
2	Directions: 13(1)
3	Diagrams: None
4	Permitted variants: Schedule 16, Items 12, 33
5	Illumination requirements: Schedule 17, item 4

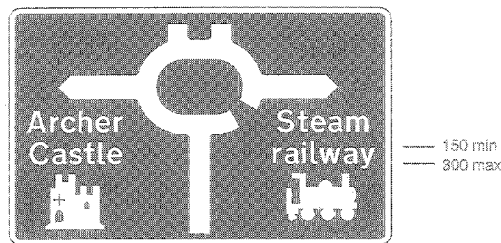

2925  
Roundabout ahead leading from a motorway exit side road to the tourist attractions shown

Item	
1	Regulations: None
2	Directions: 13(1)
3	Diagrams: None
4	Permitted variants: Schedule 16, Items 5, 6, 16, 18, 19, 25, 21, 32, 33
5	Illumination requirements: Schedule 17, item 4

**Status:** This is the original version (as it was originally made). This item of legislation is currently only available in its original format.

SCHEDULE 7 PART X MOTORWAY SIGNS (contd.)

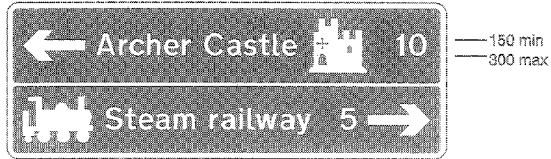

2926  
Junction ahead from a motorway exit slip road to the tourist attractions shown

Item	
1	Regulations: None
2	Directions: 13(1)
3	Diagrams: None
4	Permitted variants: Schedule 16, items 5, 12, 16, 19, 20, 29, 31, 32, 33
5	Illumination requirements: Schedule 17, item 4

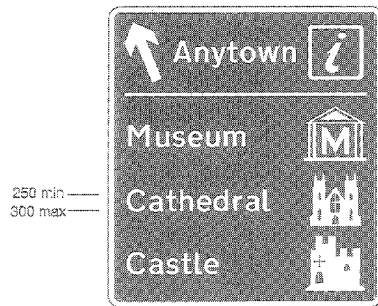

2927  
Motorway junction ahead leading to a town or geographical area in England or Scotland containing a Tourist Information Point or Centre and several tourist attractions

Item	
1	Regulations: None
2	Directions: 13(1)
3	Diagrams: None
4	Permitted variants: Schedule 16, items 18, 33
5	Illumination requirements: Schedule 17, item 4



**Status:** This is the original version (as it was originally made). This item of legislation is currently only available in its original format.

SCHEDULE 7 PART X MOTORWAY SIGNS (contd.)



2928  
County or (in Scotland) regional boundary

Item	
1	Regulations: None
2	Directions: 13(1)
3	Diagrams: None
4	Permitted variants: Schedule 16, item 19 The county's crest and either a message of welcome or a phrase denoting an item of local geographical or historical interest, not exceeding 3 words in either case, may be added
5	Illumination requirements: Schedule 17, item 4

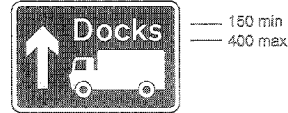

2929  
Motorway junction ahead leading to route advised for goods vehicles to the destination shown, which differs from that for other traffic

Item	
1	Regulations: None
2	Directions: 13(1)
3	Diagrams: None
4	Permitted variants: Schedule 16, items 12, 19, 20, 28 Route numbers shall be shown in white characters on the black background
5	Illumination requirements: Schedule 17, item 1

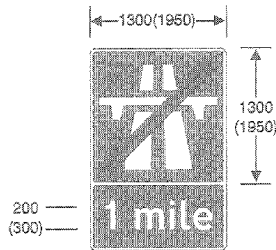

2930  
Regulations referred to in the caption under diagram 2901 cease to apply ahead

Item	
1	Regulations: None
2	Directions: 13(1)
3	Diagrams: None
4	Permitted variants: "1 mile" may be varied to "1/2 mile"
5	Illumination requirements: Schedule 17, item 1

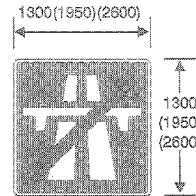

2931  
Regulations referred to in the caption under diagram 2901 cease to apply at this point

Item	
1	Regulations: None
2	Directions: 13(1)
3	Diagrams: None
4	Permitted variants: None
5	Illumination requirements: Schedule 17, item 1

**Status:** This is the original version (as it was originally made). This item of legislation is currently only available in its original format.

SCHEDULE 7 PART X MOTORWAY SIGNS (contd.)

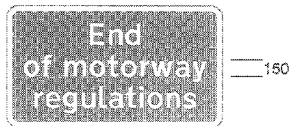

2932  
Entrance to motorway service area, maintenance compound or similar facility contained within the length of a motorway and indicating that the Regulations referred to in the caption under diagram 2901 cease to apply at this point

Item	
1	Regulations: 12(3)
2	Directions: 13(1)
3	Diagrams: None
4	Permitted variants: None
5	Illumination requirements: Schedule 17, Item 4

**Status:** This is the original version (as it was originally made). This item of legislation is currently only available in its original format.

SCHEDULE 8

Regulations 30, 31, 32

LIGHT SIGNALS FOR THE CONTROL OF VEHICULAR TRAFFIC

SCHEDULE 8

Regulations 30,31,32

LIGHT SIGNALS FOR THE CONTROL OF VEHICULAR TRAFFIC

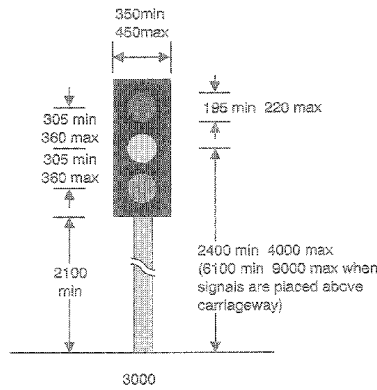

3000  
Light signals for the control of vehicular traffic at road junctions, at places where the headroom or width of the road is permanently reduced or at places where pedestrians cross the road (other than "Pelican" crossings)

Item	
1	Regulations: 10(1), 10(2), 30(2), 30(4), 31, 33(1), 33(2)
2	Directions: 16, 19, 41, 42, 46, 49
3	Diagrams: 543.1, 1001, 1055
4	Permitted variants: A green arrow may be substituted for the green aspect in the manner shown in diagram 3003 or added below the green lens in the manner shown in diagram 3003.1

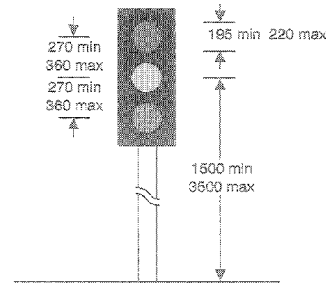

3000.1  
Portable light signals

Item	
1	Regulations: 10(1), 10(2), 30(4), 32, 33(1), 33(2)
2	Directions: 16, 41, 47, 49
3	Diagrams: 1001, 7011
4	Permitted variants: None

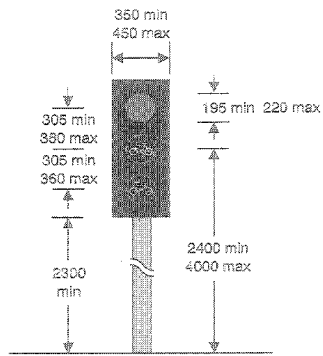

3000.2  
Light signals for the control of vehicular traffic consisting solely of pedal cycles

Item	
1	Regulations: 10(1), 10(2), 30(3), 30(4), 33(1), 33(2)
2	Directions: 16, 41, 42, 46, 49
3	Diagrams: 1001, 1055
4	Permitted variants: None

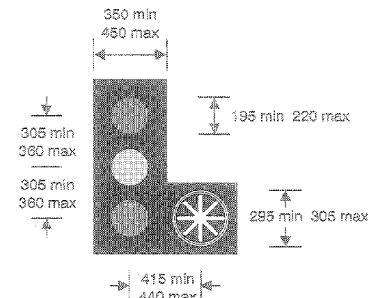

3000.3  
As for diagram 3000 with an additional signal as shown in diagram 3001, 3001.1, or 3013

Item	
1	Regulations: 10(1), 10(2), 30(2), 30(4), 30(10), 30(11), 31, 33(1), 33(2), 33(5)
2	Directions: 16, 18, 41, 42, 46, 49
3	Diagrams: 543.1, 1001, 1055
4	Permitted variants: The tram signal aspect may be mounted to the left of the signal head. A green arrow may be substituted for the tram signal aspect and/or the green aspect in the manner shown in diagrams 3002, 3004, 3005 or 3008

**Status:** This is the original version (as it was originally made). This item of legislation is currently only available in its original format.

SCHEDULE 8 LIGHT SIGNALS FOR THE CONTROL OF VEHICULAR TRAFFIC (contd.)

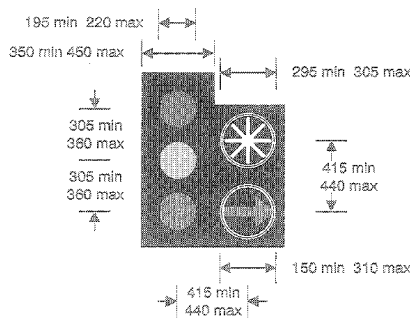

3000.4

As for diagram 3000 with two additional signals as shown in diagram 3001, 3001.1 or 3013

Item	
1	Regulations: 10(1), 10(2), 30(2), 30(4), 30(10), 30(11), 31, 33(1), 33(2), 33(5).
2	Directions: 16, 19, 41, 42, 48, 49
3	Diagrams: 543.1, 1001, 1055.
4	Permitted variants: The tram signal aspect and green arrow may be mounted on the left of the signal head. A green arrow may be substituted for the tram signal aspect in the manner shown in the diagrams 3007 or 3008

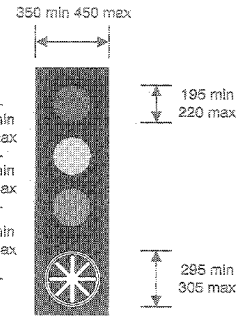

3000.5

Alternative arrangement of the signals shown in diagram 3000.3

Item	
1	Regulations: 10(1), 10(2), 30(2), 30(4), 30(10), 30(11), 31, 33(1), 33(2), 33(5)
2	Directions: 16, 19, 41, 42, 48, 49
3	Diagrams: 543.1, 1001, 1055
4	Permitted variants: A green arrow may be substituted for the tram signal aspect and the green aspect in the manner shown in diagrams 3009.1, 3011.1 or 3011.2. The tram signal aspect may be mounted above the red aspect

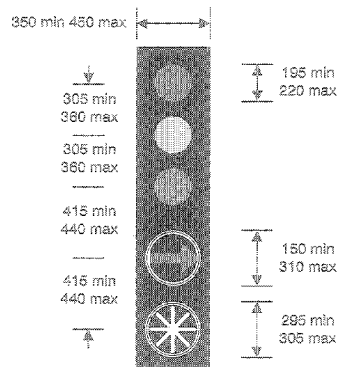

3000.6

Alternative arrangement of the signals shown in diagram 3000.4

Item	
1	Regulations: 10(1), 10(2), 30(2), 30(4), 30(10), 30(11), 31, 33(1), 33(2), 33(5)
2	Directions: 16, 19, 41, 42, 48, 49
3	Diagrams: 543.1, 1001, 1055
4	Permitted variants: A green arrow may be substituted for the tram signal aspect in the manner shown in diagram 3007 except that the two green arrows shall be mounted vertically below the green aspect.

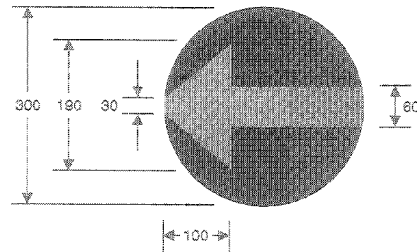

3001

Green arrow for inclusion in light signals in accordance with regulation 31

Item	
1	Regulations: 31
2	Directions: None
3	Diagrams: None
4	Permitted variants: Direction in which the arrow points may be varied as shown in diagrams 3002, 3003, 3004, 3005, 3008, 3007, 3009, 3009.1, 3011.1 or 3011.2

**Status:** This is the original version (as it was originally made). This item of legislation is currently only available in its original format.

SCHEDULE 8 LIGHT SIGNALS FOR THE CONTROL OF VEHICULAR TRAFFIC (contd.)

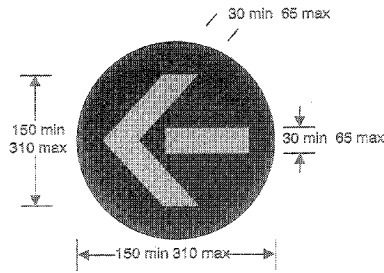

3001.1  
Same as diagram 3001

Item	
1	Regulations: 31
2	Directions: None
3	Diagrams: None
4	Permitted variants: Same as diagram 3001

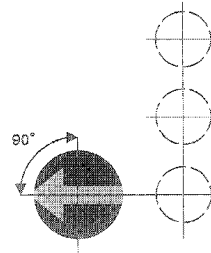

3002  
Light signals shown in diagram 3000.3 with a green arrow shown in diagram 3001 or 3001.1 substituted for the tram signal shown in diagram 3013

Item	
1	Regulations: 10(1), 10(2), 31, 33(1)
2	Directions: None
3	Diagrams: None
4	Permitted variants: The green arrow may be varied to the type shown in diagram 3001.1 See regulation 31(2)

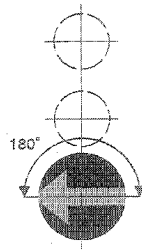

3003  
Light signals shown in diagram 3000 with a green arrow shown in diagram 3001 or 3001.1 substituted for the green signal

Item	
1	Regulations: 10(1), 10(2), 31, 33(1)
2	Directions: None
3	Diagrams: None
4	Permitted variants: The green arrow may be varied to the type shown in diagram 3001.1 See regulation 31(3)

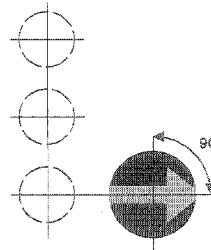

3004  
Same as diagram 3002

Item	
1	Regulations: 10(1), 10(2), 31, 33(1)
2	Directions: None
3	Diagrams: None
4	Permitted variants: The green arrow may be varied to the type shown in diagram 3001.1 See regulation 31(2)

**Status:** This is the original version (as it was originally made). This item of legislation is currently only available in its original format.

SCHEDULE 8 LIGHT SIGNALS FOR THE CONTROL OF VEHICULAR TRAFFIC (contd.)

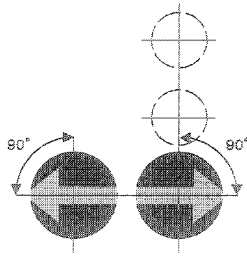

3005

Light signals shown in diagram 3000.3 with green arrows shown in diagrams 3001 or 3001.1 substituted for the green aspect and the tram signal shown in diagram 3013

Item	
1	Regulations: 10(1), 10(2), 31, 33(1)
2	Directions: None
3	Diagrams: None
4	Permitted variants: Both green arrows may be varied to the type shown in diagram 3001.1 See regulation 31(4)

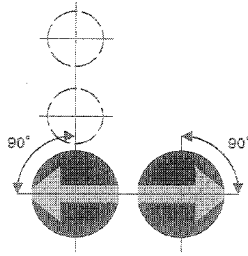

3006

Same as diagram 3005

Item	
1	Regulations: 10(1), 10(2), 31, 33(1)
2	Directions: None
3	Diagrams: None
4	Permitted variants: Both green arrows may be varied to the type shown in diagram 3001.1 See regulation 31(4)

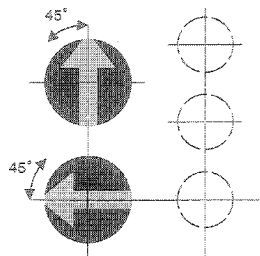

3007

Light signals shown in diagram 3000.4 with a green arrow shown in diagrams 3001 or 3001.1 substituted for the tram signal shown in diagram 3013

Item	
1	Regulations: 10(1), 10(2), 31, 33(1)
2	Directions: None
3	Diagrams: None
4	Permitted variants: Both green arrows may be varied to the type shown in diagram 3001.1 See regulation 31(5) The two green arrows may be mounted below the signal head in the manner shown in diagram 3000.6

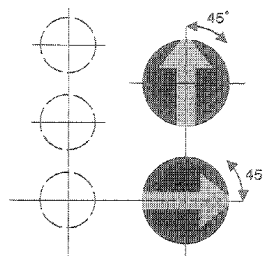

3008

Same as diagram 3007

Item	
1	Regulations: 10(1), 10(2), 31, 33(1)
2	Directions: None
3	Diagrams: None
4	Permitted variants: Same as diagram 3007

**Status:** This is the original version (as it was originally made). This item of legislation is currently only available in its original format.

SCHEDULE 8 LIGHT SIGNALS FOR THE CONTROL OF VEHICULAR TRAFFIC (contd.)

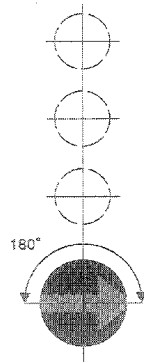

3009.1  
Light signals shown in diagram 3000 with a green arrow shown in diagram 3001 or 3001.1 added below the green signal.

Item	
1	Regulations: 10(1), 10(2), 31, 33(1)
2	Directions: None
3	Diagrams: None
4	Permitted variants: The green arrow may be varied to the type shown in diagram 3001.1 See regulation 31(3)

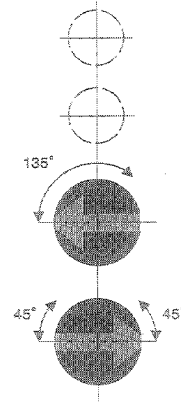

3011.1  
Light signals shown in diagram 3000 with a green arrow shown in diagram 3001 or 3001.1 substituted for the green signal and a second arrow added below that. The arrows shall be illuminated and extinguished simultaneously.

Item	
1	Regulations: 10(1), 10(2), 31, 33(1)
2	Directions: None
3	Diagrams: None
4	Permitted variants: Both green arrows may be varied to the type shown in diagram 3001.1 See regulation 31(6)

**Status:** This is the original version (as it was originally made). This item of legislation is currently only available in its original format.

SCHEDULE 8 LIGHT SIGNALS FOR THE CONTROL OF VEHICULAR TRAFFIC (contd.)

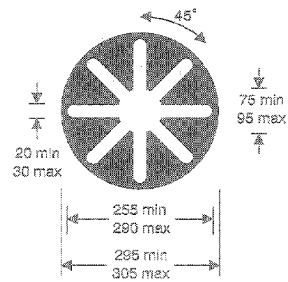
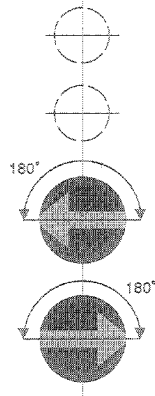

3011.2

Same as diagram 3011.1 except that the arrows shall be illuminated and extinguished separately.

Item	
1	Regulations: 10(1), 10(2), 31, 33(1)
2	Directions: None
3	Diagrams: None
4	Permitted variants: Both green arrows may be varied to the type shown in diagram 3001.1 See regulation 31(6)

3013

Light signal for the control of tramcars

Item	
1	Regulations: 10(1), 30(8), 30(10), 30(11), 33(5)
2	Directions: 41, 48
3	Diagrams: 1001, 3000.3, 3000.4, 3000.5, 3000.6
4	Permitted variants: None



**Status:** This is the original version (as it was originally made). This item of legislation is currently only available in its original format.

SCHEDULE 8 LIGHT SIGNALS FOR THE CONTROL OF VEHICULAR TRAFFIC (contd.)

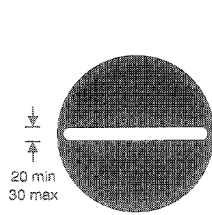

3013.1  
As diagram 3013, conveying the prohibition prescribed by regulation 33(5)(a)

Item	
1	Regulations: 10(1), 30(9), 30(10), 30(11), 33(5)
2	Directions: None
3	Diagrams: None
4	Permitted variants: None

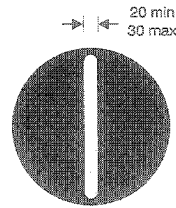

3013.2  
As diagram 3013, conveying the indication prescribed by regulation 33(5)(b)

Item	
1	Regulations: 30(9), 30(10), 30(11), 33(5)
2	Directions: None
3	Diagrams: None
4	Permitted variants: None

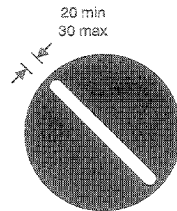

3013.3  
As diagram 3013, conveying the indication prescribed by regulation 33(5)(c)

Item	
1	Regulations: 30(9), 30(10), 30(11), 33(5)
2	Directions: None
3	Diagrams: None
4	Permitted variants: None

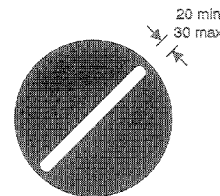

3013.4  
As diagram 3013, conveying the indication prescribed by regulation 33(5)(d)

Item	
1	Regulations: 30(9), 30(10), 30(11), 33(5)
2	Directions: None
3	Diagrams: None
4	Permitted variants: None

**Status:** This is the original version (as it was originally made). This item of legislation is currently only available in its original format.

SCHEDULE 8 LIGHT SIGNALS FOR THE CONTROL OF VEHICULAR TRAFFIC (contd.)

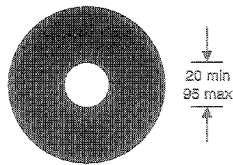
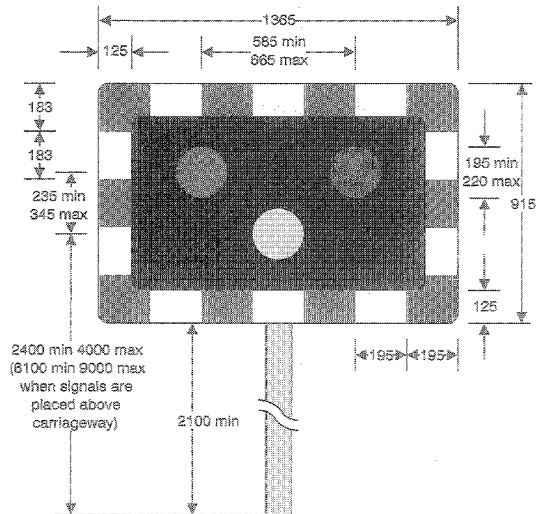

3013.5

As diagram 3013, conveying the requirement prescribed by regulation 33(5)(e)

Item	
1	Regulations: 30(9), 30(10), 30(11), 33(5)
2	Directions: None
3	Diagrams: None
4	Permitted variants: None

3014

Light signals for the control of road traffic at level crossings, swing or lifting bridges, tunnels, airfields or in the vicinity of premises used regularly by fire, police or ambulance service vehicles

Item	
1	Regulations: 10(1), 10(2), 30(7), 30(8), 33(4)
2	Directions: 16, 41, 42, 48, 49
3	Diagrams: 774, 775, 776, 777, 1001, 1003.2, 4006
4	Permitted variants: None
5	Illumination requirements: Schedule 17, item 15

**Status:** This is the original version (as it was originally made). This item of legislation is currently only available in its original format.

SCHEDULE 9

Regulations 37-40

LIGHT SIGNALS FOR PEDESTRIANS AND ANIMAL CROSSINGS

SCHEDULE 9  
LIGHT SIGNALS FOR PEDESTRIANS AND ANIMAL CROSSINGS

Regulations 37-40

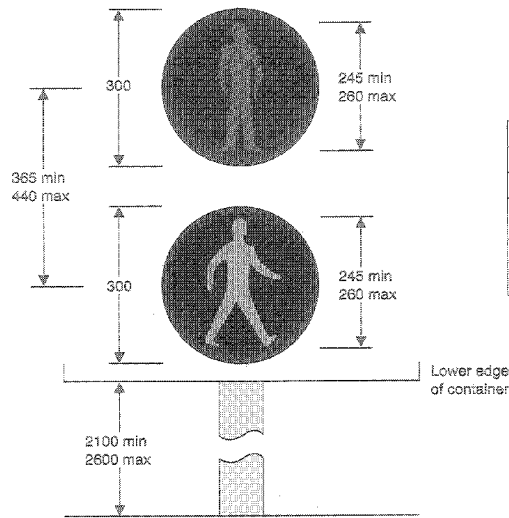

4002  
Light signals for pedestrians

Item	
1	Regulations: 37
2	Directions: 41, 48, 49
3	Diagrams: 4003, 1055
4	Permitted variants: None

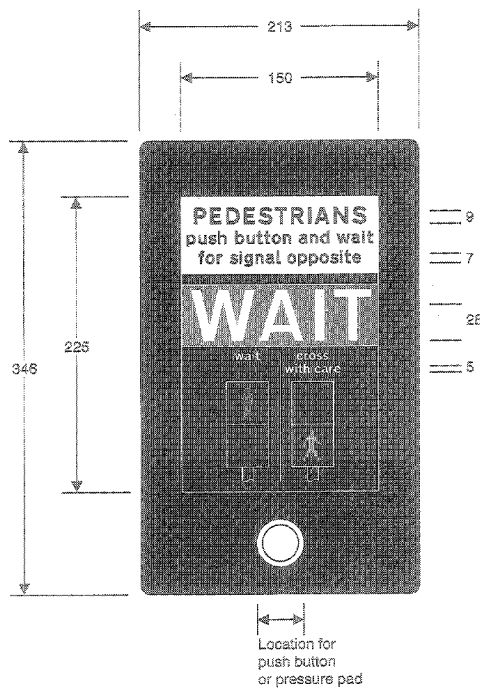

4003  
Instructions to pedestrians above the push button control for calling up pedestrian phases at light signals

Item	
1	Regulations: 37(3)
2	Directions: 48, 49
3	Diagrams: 4002
4	Permitted variants: None

**Status:** This is the original version (as it was originally made). This item of legislation is currently only available in its original format.

SCHEDULE 9 LIGHT SIGNALS FOR PEDESTRIANS AND ANIMAL CROSSINGS (contd.)

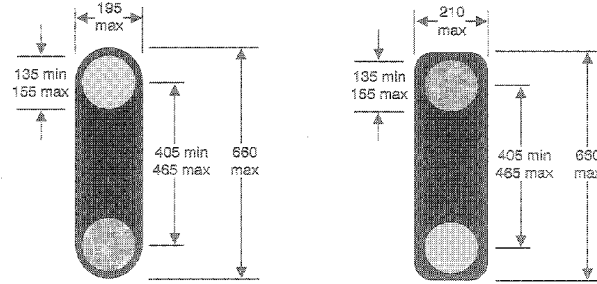

4004

Children likely to be crossing the road on their way to or from school ahead (Alternative types)

item	
1	Regulations: 39(2)
2	Directions: 16, 25, 41, 48, 49
3	Diagrams: 546, 548, 547.1
4	Permitted variants: Container may be coloured grey

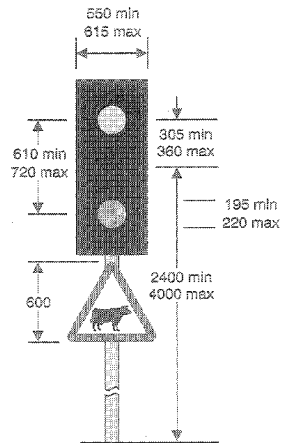

4005

Cattle crossing ahead

item	
1	Regulations: 40
2	Directions: 19, 41, 48, 49
3	Diagrams: None
4	Permitted variants: None
5	Illumination requirements: Schedule 17 item 4 (in respect of warning sign)

**Status:** This is the original version (as it was originally made). This item of legislation is currently only available in its original format.

SCHEDULE 9 LIGHT SIGNALS FOR PEDESTRIANS AND ANIMAL CROSSINGS (contd.)

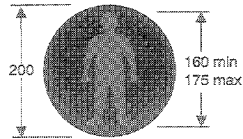

4006  
Light signal at level crossings for pedestrians

Item	
1	Regulations: 38
2	Directions: 41, 42, 49
3	Diagrams: 1003.2, 3D14
4	Permitted variants: None

**Status:** This is the original version (as it was originally made). This item of legislation is currently only available in its original format.

## SCHEDULE 10

Regulation 34

**Status:** This is the original version (as it was originally made). This item of legislation is currently only available in its original format.

## PART I LANE CONTROL SIGNALS

### SCHEDULE 10 PART 1 LANE CONTROL SIGNALS

Regulation 34

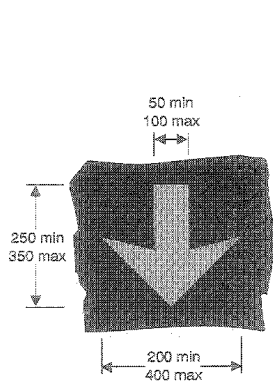

5001.1  
Lane open to vehicular traffic

Item	
1	Regulations: 13(1), 19(1), 34
2	Directions: 7, 41, 49
3	Diagrams: None
4	Permitted variants: None

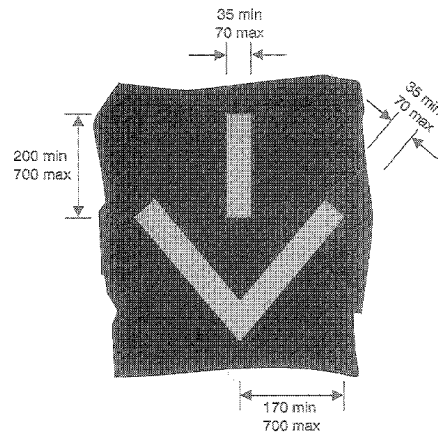

5001.2  
Same as diagram 5001.1

Item	
1	Regulations: 13(1), 19(1), 34
2	Directions: 7, 41, 49
3	Diagrams: None
4	Permitted variants: None

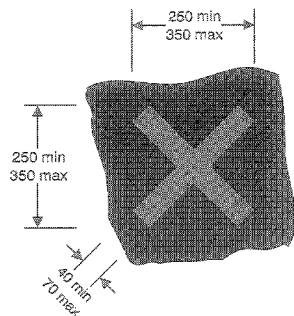

5003  
Lane closed to vehicular traffic

Item	
1	Regulations: 13(1), 19(1), 34
2	Directions: 7, 41, 49
3	Diagrams: None
4	Permitted variants: None

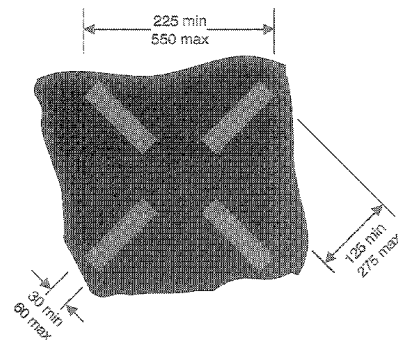

5003.1  
Same as diagram 5003

Item	
1	Regulations: 13(1), 19(1), 34
2	Directions: 7, 41, 49
3	Diagrams: None
4	Permitted variants: None

**Status:** This is the original version (as it was originally made). This item of legislation is currently only available in its original format.

SCHEDULE 10 PART 1 LANE CONTROL SIGNALS (contd.)

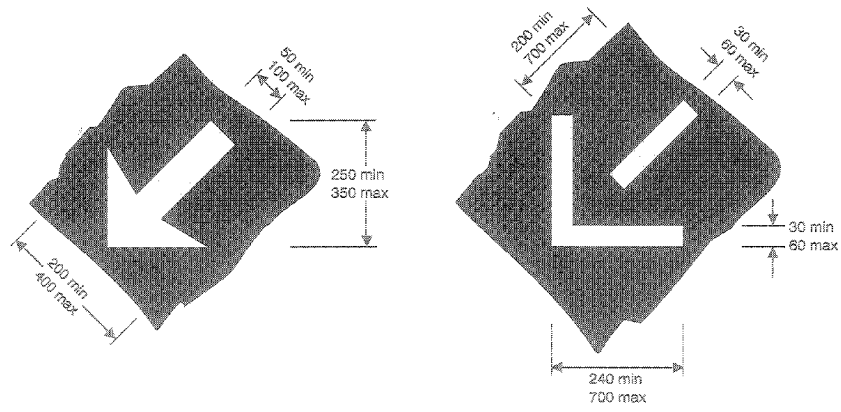

5005  
Lane closed ahead and vehicular traffic should move to the next lane on the left

Item	
1	Regulations: 13(1), 19(1), 34
2	Directions: 7, 41, 49
3	Diagrams: None
4	Permitted variants: None

5005.1  
Same as diagram 5005

Item	
1	Regulations: 13(1), 19(1), 34
2	Directions: 7, 41, 49
3	Diagrams: None
4	Permitted variants: None



**Status:** This is the original version (as it was originally made). This item of legislation is currently only available in its original format.

## PART II

### LANE CONTROL SIGNS

#### SCHEDULE 10 PART II LANE CONTROL SIGNS

Regulation 11(1)

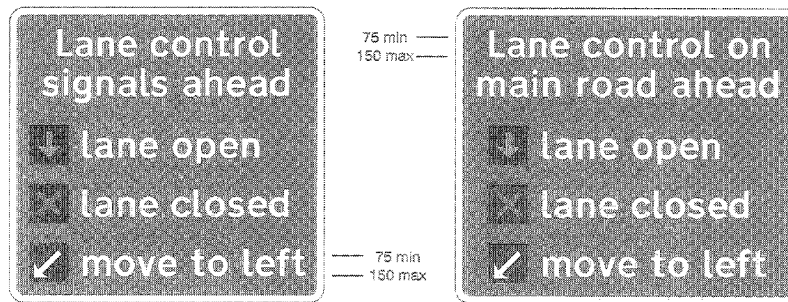

**5010**  
Lane control light signals ahead  
as shown in diagrams 5001.1, 5003 and 5005  
or diagrams 5001.2, 5003.1 and 5005.1

Item	
1	Regulations: None
2	Directions: None
3	Diagrams: None
4	Permitted variants: The diagonal white arrow symbol and the words "Move to the left" shall be omitted where the signals shown in diagram 5005 or 5005.1 are not used in the lane control system.
5	Illumination requirements: Schedule 17, item 1

**5011**  
Lane control light signals as shown in diagrams 5001.1, 5003 and 5005 or diagrams 5001.2, 5003.1 and 5005.1 on a road extending from a junction ahead

Item	
1	Regulations: None
2	Directions: None
3	Diagrams: None
4	Permitted variants: Same as diagram 5010
5	Illumination requirements: Schedule 17, item 1

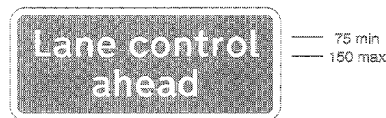

**5012**  
System of lane control signals ahead

Item	
1	Regulations: None
2	Directions: None
3	Diagrams: None
4	Permitted variants: None
5	Illumination requirements: Schedule 17, item 4

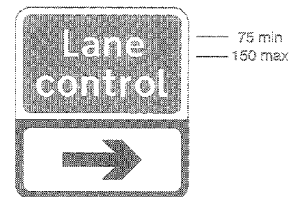

**5013**  
Direction of a system  
of lane control light signals

Item	
1	Regulations: None
2	Directions: None
3	Diagrams: None
4	Permitted variants: Schedule 16, item 13
5	Illumination requirements: Schedule 17, item 4

**Status:** This is the original version (as it was originally made). This item of legislation is currently only available in its original format.

SCHEDULE 10 PART II LANE CONTROL SIGNS (contd.)

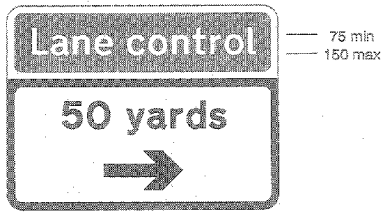

5014  
Distance to and direction of  
a system of lane control light signals

Item	
1	Regulations: None
2	Directions: None
3	Diagrams: None
4	Permitted variants: Schedule 16, items 6, 13
5	Illumination requirements: Schedule 17, item 4

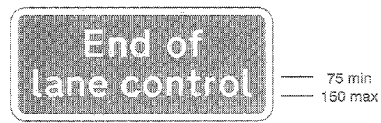

5015  
End of a system of lane  
control light signals

Item	
1	Regulations: 34(4)
2	Directions: None
3	Diagrams: None
4	Permitted variants: None
5	Illumination requirements: Schedule 17, item 4

## SCHEDULE 11

### Regulation 36

Status: This is the original version (as it was originally made). This item of legislation is currently only available in its original format.

# PART I

## MATRIX SIGNS

(for motorways and dual carriageway roads)

### SCHEDULE 11 PART I MATRIX SIGNS (for motorways and dual carriageway roads)

Regulation 36

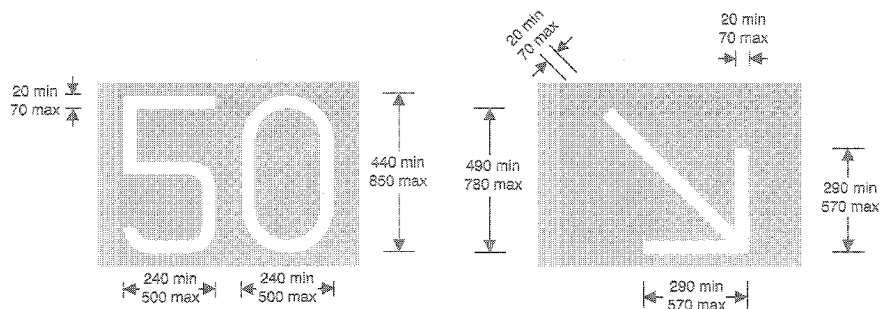

6001  
Temporary maximum speed advised

Item	
1	Regulations: 34(4), 36
2	Directions: 41, 44, 45, 49
3	Diagrams: 6021, 6022
4	Permitted variants: Schedule 16, Item 1

6002  
Vehicular traffic must move to the next lane on the right

Item	
1	Regulations: 36
2	Directions: 41, 44, 45, 49
3	Diagrams: 6021
4	Permitted variants: Arrow may point downwards to the left

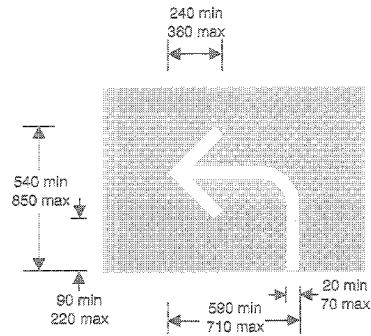

6003  
Vehicular traffic must leave at next junction

Item	
1	Regulations: 35
2	Directions: 41, 44, 45, 49
3	Diagrams: 6021, 6022
4	Permitted variants: Schedule 16, Item 26

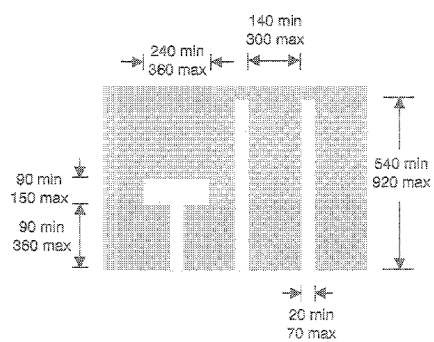

6006  
Closure of one lane of a three lane carriageway ahead

Item	
1	Regulations: 35
2	Directions: 41, 44, 45, 48, 49
3	Diagrams: 6022
4	Permitted variants: Schedule 16, Item 15

**Status:** This is the original version (as it was originally made). This item of legislation is currently only available in its original format.

SCHEDULE 11 PART I MATRIX SIGNS (contd.)

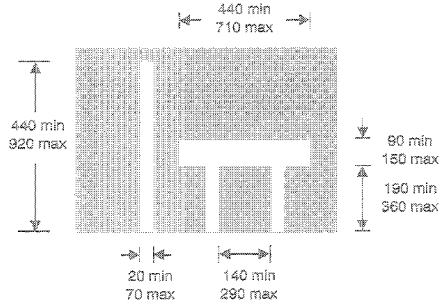

6006.1  
Closure of two lanes  
of a three lane carriageway ahead

Item	
1	Regulations: 36
2	Directions: 41, 44, 45, 48, 49
3	Diagrams: 6022
4	Permitted variants: Schedule 16, Item 16

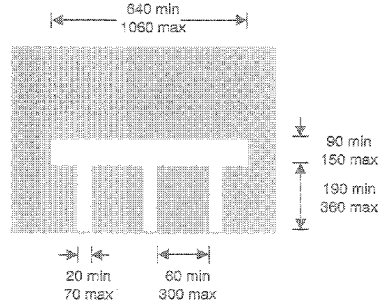

6006.2  
Closure of all lanes  
of a three lane carriageway ahead

Item	
1	Regulations: 36
2	Directions: 41, 44, 48, 49
3	Diagrams: 6031.1, 6032.1
4	Permitted variants: None

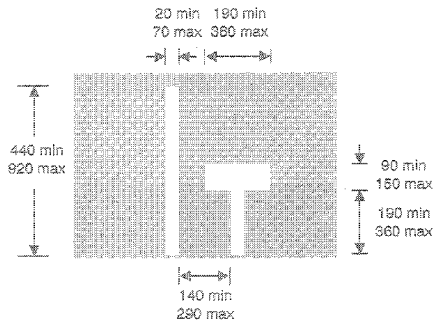

6008  
Closure of right hand lane  
of a two lane carriageway ahead

Item	
1	Regulations: 36
2	Directions: 41, 44, 45, 48, 49
3	Diagrams: 6022
4	Permitted variants: Schedule 16, Item 16

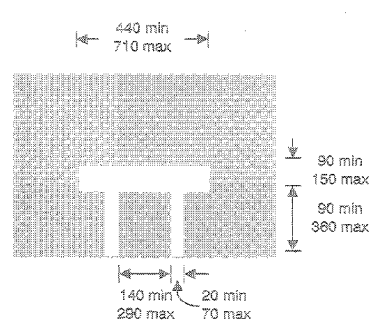

6008.1  
Closure of both lanes  
of a two lane carriageway ahead

Item	
1	Regulations: 36
2	Directions: 41, 44, 46, 49
3	Diagrams: 6031.1, 6032.1
4	Permitted variants: None

**Status:** This is the original version (as it was originally made). This item of legislation is currently only available in its original format.

SCHEDULE 11 PART I MATRIX SIGNS (contd.)

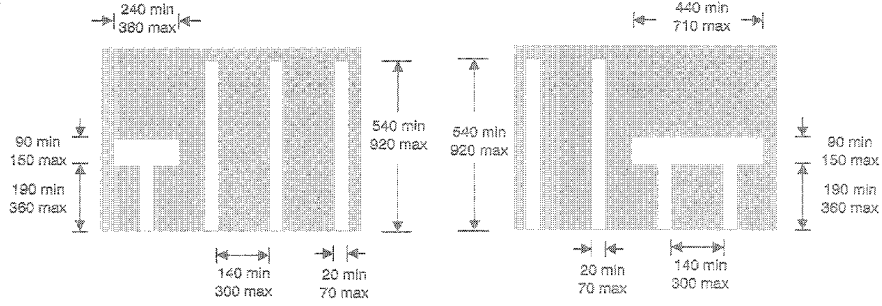

6009  
Closure of one lane  
of a four lane carriageway ahead

Item	
1	Regulations: 36
2	Directions: 41, 44, 45, 46, 49
3	Diagrams: 6022
4	Permitted variants: Schedule 16, Item 16

6009.1  
Closure of two lanes  
of a four lane carriageway ahead

Item	
1	Regulations: 36
2	Directions: 41, 44, 45, 46, 49
3	Diagrams: 6022
4	Permitted variants: Schedule 16, Item 16

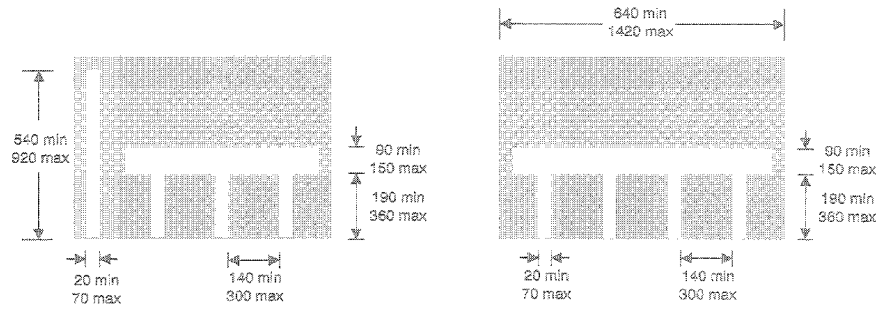

6009.2  
Closure of three lanes  
of a four lane carriageway ahead

Item	
1	Regulations: 36
2	Directions: 41, 44, 45, 46, 49
3	Diagrams: 6022
4	Permitted variants: Schedule 16, Item 16

6009.3  
Closure of all lanes  
of a four lane carriageway ahead

Item	
1	Regulations: 36
2	Directions: 41, 44, 45, 49
3	Diagrams: 6009.1, 6009.2
4	Permitted variants: None

**Status:** This is the original version (as it was originally made). This item of legislation is currently only available in its original format.

SCHEDULE 11 PART I MATRIX SIGNS (contd.)

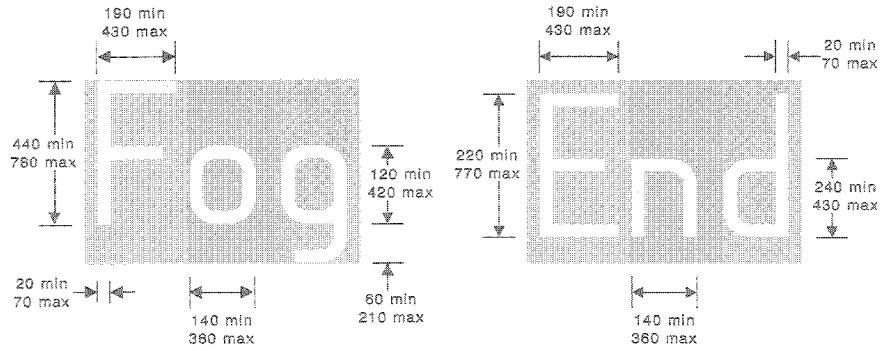

8011  
Risk of fog ahead

8012  
End of temporary restrictions  
indicated by previous signs

Item	
1	Regulations: 36
2	Directions: 41, 44, 45, 49
3	Diagrams: 6021, 6022
4	Permitted variants: None

Item	
1	Regulations: 36
2	Directions: 41, 44, 45, 49
3	Diagrams: None
4	Permitted variants: None

**Status:** This is the original version (as it was originally made). This item of legislation is currently only available in its original format.

SCHEDULE 11 PART I MATRIX SIGNS (contd.)

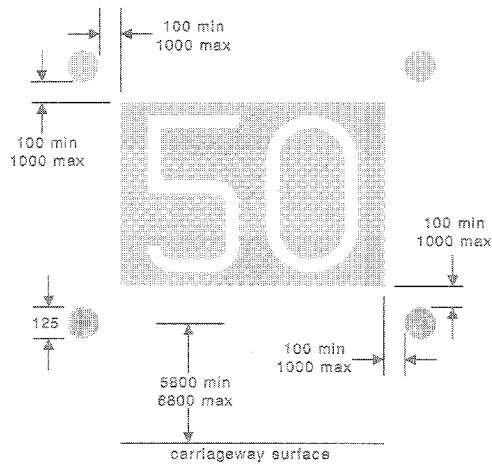

6021  
Gantry mounted signal with flashing  
amber lamps for displaying the signs shown in  
diagrams 6001, 6002, 6003 or 6011

Item	
1	Regulations: 36
2	Directions: 41, 44, 46, 49
3	Diagrams: 6001, 6002, 6003, 6011
4	Permitted variants: "50" maybe varied to any of the legends shown in diagrams 6001, 6002, 6003 or 6011



**Status:** This is the original version (as it was originally made). This item of legislation is currently only available in its original format.

SCHEDULE 11 PART I MATRIX SIGNS (contd.)

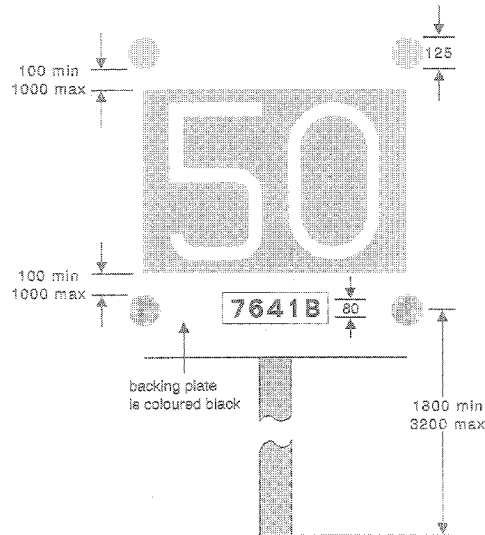

6022  
 Post mounted signal with flashing amber lamps for displaying the signs shown in diagrams 6001, 6003, 6006, 6006.1, 6008, 6009, 6009.1, 6009.2 or 6011

Item	
1	Regulations: 36
2	Directions: 41, 44, 46, 48
3	Diagrams: 6001, 6003, 6006, 6006.1, 6008, 6009, 6009.1, 6009.2, 6011.
4	Permitted variants: "50" may be varied to any of the legends shown in diagrams 6001, 6003, 6006, 6006.1, 6008, 6009, 6009.1, 6009.2 or 6011

**Status:** This is the original version (as it was originally made). This item of legislation is currently only available in its original format.

## PART II

### LIGHT SIGNALS

(for motorways and dual carriageway roads)

SCHEDULE 11 PART II  
LIGHT SIGNALS  
(for motorways and dual carriageway roads)

Regulations 30 and 35

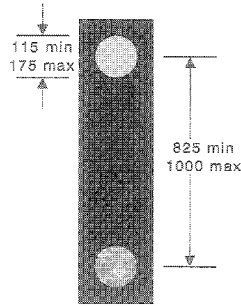

6023  
Light signal conveying the warning prescribed in regulation 35

Item	
1	Regulations: 35
2	Directions: 41, 44, 48
3	Diagrams: None
4	Permitted variants: None

**Status:** This is the original version (as it was originally made). This item of legislation is currently only available in its original format.

SCHEDULE 11 PART II LIGHT SIGNALS (contd.)

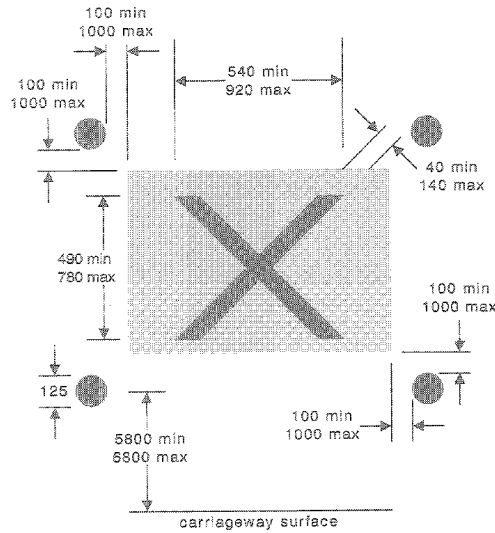

6031.1  
Light signals for conveying the requirements prescribed in regulation 33(3)(b)

Item	
1	Regulations: 30(5), 30(6), 33(3)
2	Directions: 41, 44, 45, 46, 49
3	Diagrams: 6006.2, 6008.1, 6009.3
4	Permitted variants: A sign shown in diagram 6002.2, 6008.1 or 6009.3 may be substituted for the red cross symbol

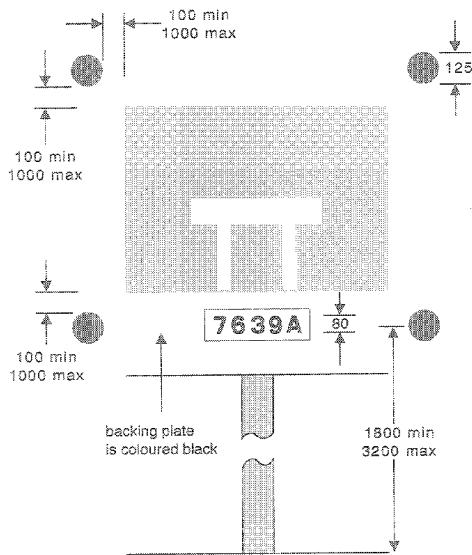

6032.1  
Light signals conveying the requirements prescribed in regulation 33(3)(a)

Item	
1	Regulations: 30(5), 30(6), 33(3)
2	Directions: 41, 44, 45, 46, 49
3	Diagrams: 6006.2, 6009.3
4	Permitted variants: The diagram 6008.1 symbol may be varied to the symbol shown in diagram 6006.2 or 6009.3

**Status:** This is the original version (as it was originally made). This item of legislation is currently only available in its original format.

## SCHEDULE 12

Regulation 11(1)

**Status:** This is the original version (as it was originally made). This item of legislation is currently only available in its original format.

# PART I

## MISCELLANEOUS WARNING, INFORMATORY AND REGULATORY SIGNS FOR ROAD WORKS

### SCHEDULE 12 PART I MISCELLANEOUS WARNING, INFORMATORY AND REGULATORY SIGNS FOR ROAD WORKS

Regulation 11(1)

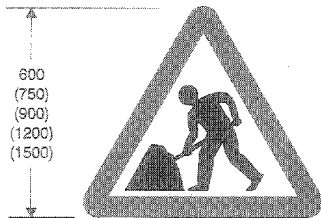

**7001**  
Road works or temporary obstruction  
of the carriageway ahead

Item	
1	Regulations: 14, 42
2	Directions: 9, 19, 31
3	Diagrams: 570, 572, 573, 645, 7001.1, 7001.2, 7021
4	Permitted variants: None
5	Illumination requirements: Schedule 17, item 1

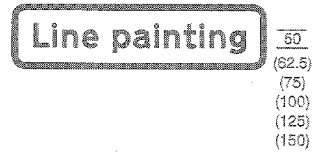

**7001.1**  
Nature of road works

Item	
1	Regulations: 14
2	Directions: 19, 31
3	Diagrams: 7001
4	Permitted variants: "Line painting" may be shown on two lines or varied to: 1. "Grass cutting" 2. "Tree cutting" 3. "Hedge cutting" 4. "Ditching" 5. "Weed spraying" 6. "Sign erection" 7. "Sign maintenance" 8. "Lighting maintenance" 9. "Overhead works" 10. "On slip road" 11. "Surveying" 12. "Mobile road works" 13. "Road sweeping" 14. "Gully emptying" 15. "Gutting" 16. "Salting" 17. "Snow ploughing" 18. "Blasting" 19. "On hard shoulder"
5	Illumination requirements: Schedule 17, item 3

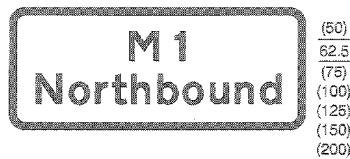

**7001.2**  
Location of road works immediately ahead  
on route indicated

Item	
1	Regulations: None
2	Directions: 19, 31
3	Diagrams: 7001
4	Permitted variants: Schedule 16, item 20 Direction may be varied or omitted and "On" added before route number
5	Illumination requirements: Schedule 17, item 8

Status: This is the original version (as it was originally made). This item of legislation is currently only available in its original format.

SCHEDULE 12 PART I MISCELLANEOUS WARNING, INFORMATORY AND REGULATORY SIGNS FOR ROAD WORKS (contd.)

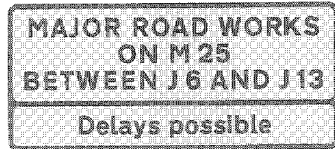

75 min  
250 max

7002  
Major road works at a specified location ahead

Item	
1	Regulations: None
2	Directions: 13(1), 31
3	Diagrams: None
4	Permitted variants: Schedule 16, item 20 The route number and the word "ON" may be omitted. "BETWEEN" may be varied to "AT" and the second junction number and the word "AND" omitted. "J" may be varied to "JUNCTION". Junction numbers may be varied to local place names. The motorway number may be varied to an all-purpose road number or the name of a road. A date may be added to the top panel. "MAJOR ROAD WORKS" may be on two lines. "BETWEEN" may be on a separate line. The legend in the top panel may be on two lines
5	Illumination requirements: Schedule 17, item 1

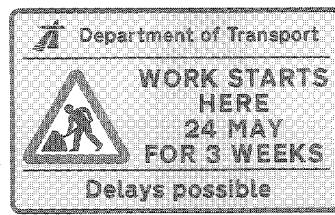

60 min  
200 max  
75 min  
250 max

7003  
Starting date and duration of road works

Item	
1	Regulations: None
2	Directions: 31
3	Diagrams: None
4	Permitted variants: Schedule 16, items 37, 39 Duration of work may be varied
5	Illumination requirements: Schedule 17, item 4

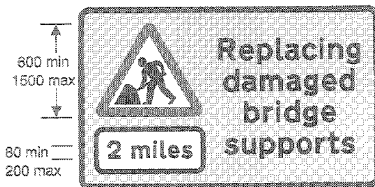

100 min  
250 max

800 min  
1500 max  
80 min  
200 max

7004  
Road works ahead and the nature of works indicated

Item	
1	Regulations: None
2	Directions: 31
3	Diagrams: None
4	Permitted variants: "Replacing damaged bridge supports" may be varied to a short description of the work in progress or explanation of why work is suspended. The distance plate may be replaced with a plate of the type shown in diagram 570 in which case item 5 of Schedule 16 applies. The diagram 7001 sign and distance plate may be omitted
5	Illumination requirements: Schedule 17, item 1



100 min  
250 max

800 min  
1500 max  
80 min  
200 max

7005  
Delays possible for specified period due to road works ahead

Item	
1	Regulations: None
2	Directions: 31
3	Diagrams: None
4	Permitted variants: Schedule 16, item 37 The phrase "until Sept 99" may be omitted
5	Illumination requirements: Schedule 17, item 1

**Status:** This is the original version (as it was originally made). This item of legislation is currently only available in its original format.

SCHEDULE 12 PART I MISCELLANEOUS WARNING, INFORMATORY AND REGULATORY SIGNS FOR ROAD WORKS (contd.)



7006  
End of road works and of any associated temporary statutory restrictions

Item	
1	Regulations: None
2	Directions: 9, 31
3	Diagrams: None
4	Permitted variants: Schedule 16, item 39
5	Illumination requirements: Schedule 17, item 1

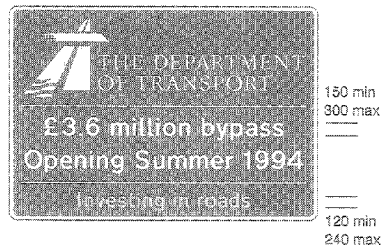

7007  
Relevant particulars of major construction or improvement scheme being carried out on road ahead

Item	
1	Regulations: None
2	Directions: 31
3	Diagrams: None
4	Permitted variants: Schedule 18, items 37, 38 Details of the scheme shall be varied as appropriate. A reference to EC support may be added
5	Illumination requirements: Schedule 17, item 9

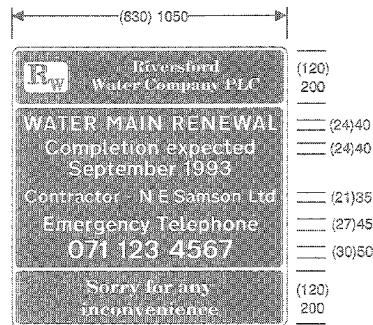

7008  
Nature of street works, giving names of employer and contractor, emergency telephone number, and apology for inconvenience

Item	
1	Regulations: 13(1), 13(4)
2	Directions: 31
3	Diagrams: None
4	Permitted variants: Details shown shall be varied as appropriate, but the emergency telephone number must be the most prominent item. The top and bottom panels may be in any colours and style of lettering. The bottom panel may be omitted. The top panel may be omitted and the Undertaker's name shown on the main panel
5	Illumination requirements: Schedule 17, item 9

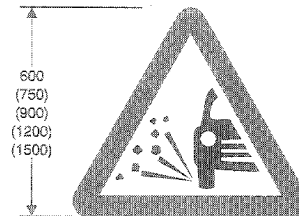

7009  
Loose chippings on road ahead

Item	
1	Regulations: 42
2	Directions: 19, 31
3	Diagrams: 513.2, 570, 572, 573
4	Permitted variants: None
5	Illumination requirements: Schedule 17, item 1

Status: This is the original version (as it was originally made). This item of legislation is currently only available in its original format.

SCHEDULE 12 PART I MISCELLANEOUS WARNING, INFORMATORY AND REGULATORY SIGNS FOR ROAD WORKS (contd.)



7010  
Vehicular traffic should proceed slowly owing to temporary hazard resulting from wet tar on the road

Item	
1	Regulations: 42
2	Directions: 31
3	Diagrams: None
4	Permitted variants: "SLOW WET TAR" may be varied to: 1. "RAMP AHEAD" 2. "ROAD AHEAD CLOSED" 3. "ROAD CLOSED" (name of road may be substituted for "ROAD") 4. "TEMPORARY ROAD SURFACE" 5. "TRAFFIC CONTROL AHEAD" 6. "TRAFFIC SIGN MAINTENANCE" 7. "TRAFFIC SIGNAL MAINTENANCE" 8. "WORK IN CENTRE OF ROAD"
5	Illumination requirements: Schedule 17, item 1

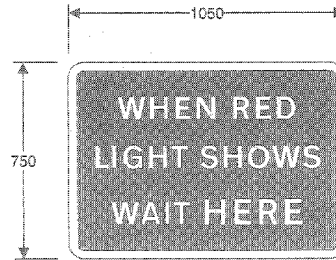

7011  
Point beyond which vehicular traffic must not proceed when required to stop by regulation 33 in accordance with the indication given by the portable light signals shown in diagram 3000.1 and when the road marking shown in diagram 1001 is not placed on the carriageway

Item	
1	Regulations: 33
2	Directions: 31
3	Diagrams: 3000.1, 7023
4	Permitted variants: "RED LIGHT" may be varied to "STOP SIGN"
5	Illumination requirements: Schedule 17, item 1

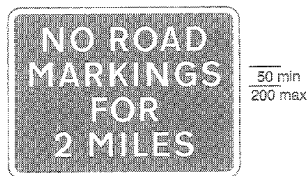

7012  
Temporary absence of road markings

Item	
1	Regulations: 42
2	Directions: 31
3	Diagrams: None
4	Permitted variants: Schedule 16, item 6 "NO ROAD MARKINGS FOR 2 MILES" may be varied to: 1. "NO GIVE WAY MARKINGS" 2. "NO STOP MARKINGS" 3. "NO ROAD MARKINGS" 4. "NO ROAD MARKINGS AT JUNCTION" 5. "NO ROAD MARKINGS AT LEVEL CROSSING"
5	Illumination requirements: Schedule 17, item 1



**Status:** This is the original version (as it was originally made). This item of legislation is currently only available in its original format.

SCHEDULE 12 PART 1 MISCELLANEOUS WARNING, INFORMATORY AND REGULATORY SIGNS FOR ROAD WORKS (contd.)

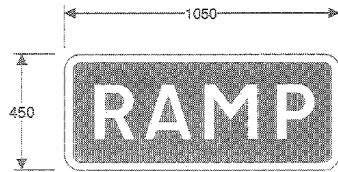

7013  
Temporary sudden change in level of carriageway surface

Item	
1	Regulations: 42
2	Directions: 31
3	Diagrams: None
4	Permitted variants: None
5	Illumination requirements: Schedule 17, item 1

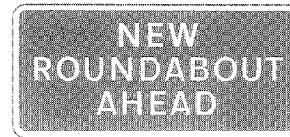

7014  
Permanent change in road layout ahead

Item	
1	Regulations: None
2	Directions: 31, 32
3	Diagrams: None
4	Permitted variants: Schedule 16, item 3 "NEW ROUNDABOUT" may be varied to: 1. "CHANGED PRIORITIES" 2. "GAP CLOSED" 3. "NEW ONE WAY SYSTEM" 4. "NEW ROAD LAYOUT" 5. "NEW TRAFFIC ISLANDS" 6. "NEW TRAFFIC SIGNALS" 7. "SIGNAL PRIORITIES CHANGED" 8. "SIGNAL TIMINGS CHANGED" A distance in yards to the nearest 10 yards may be added before the word "AHEAD" on a separate line where necessary
5	Illumination requirements: Schedule 17, item 4

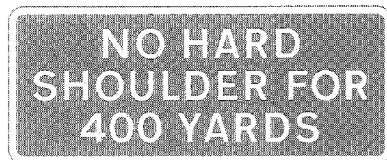

7015  
Temporary absence of hard shoulder for distance specified

Item	
1	Regulations: None
2	Directions: 31
3	Diagrams: None
4	Permitted variants: Schedule 16, item 6 "SHOULDER FOR" may be on two lines. Legend may be varied to "SETTING OUT ROAD WORKS AHEAD"
5	Illumination requirements: Schedule 17, item 4

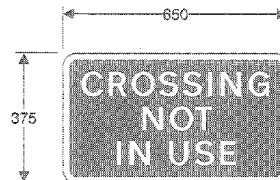

7016  
Zebra or Pelican crossing temporarily out of use (Sign for pedestrians)

Item	
1	Regulations: None
2	Directions: 31
3	Diagrams: None
4	Permitted variants: None
5	Illumination requirements: Schedule 17, item 9

**Status:** This is the original version (as it was originally made). This item of legislation is currently only available in its original format.

SCHEDULE 12 PART I MISCELLANEOUS WARNING, INFORMATORY AND REGULATORY SIGNS FOR ROAD WORKS (contd.)

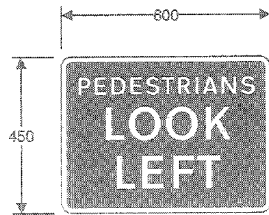

7017  
Direction in which pedestrians should look for approaching traffic (Sign for pedestrians)

Item	
1	Regulations: None
2	Directions: 31
3	Diagrams: None
4	Permitted variants: "LEFT" may be varied to "RIGHT" or "BOTH WAYS"
5	Illumination requirements: Schedule 17, item 9

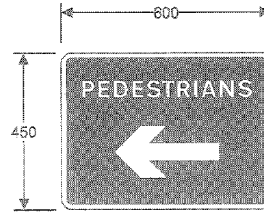

7018  
Direction of temporary route for pedestrians (Sign for pedestrians)

Item	
1	Regulations: None
2	Directions: 31
3	Diagrams: None
4	Permitted variants: Schedule 16, item 12 "USE OTHER FOOTWAY" may be added in the place of the arrow
5	Illumination requirements: Schedule 17, item 9

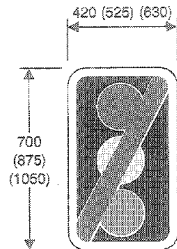

7019  
Light signals ahead not in use

Item	
1	Regulations: 42
2	Directions: 31
3	Diagrams: None
4	Permitted variants: None
5	Illumination requirements: Schedule 17, item 4

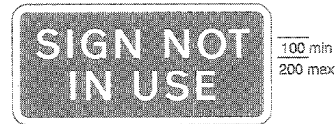

7020  
Variable message sign ahead not in use or being tested

Item	
1	Regulations: 42
2	Directions: 31
3	Diagrams: None
4	Permitted variants: "SIGN" may be varied to "SIGNAL" "NOT IN USE" may be varied to "UNDER TEST". The legend may be on three lines
5	Illumination requirements: Schedule 17, item 4

**Status:** This is the original version (as it was originally made). This item of legislation is currently only available in its original format.

SCHEDULE 12 PART I MISCELLANEOUS WARNING,  
INFORMATORY AND REGULATORY SIGNS  
FOR ROAD WORKS (contd.)

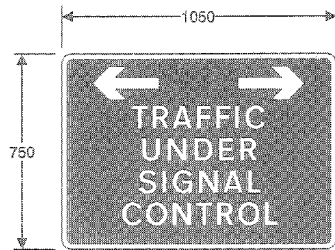

7021  
Traffic on road ahead is being controlled by portable light signals  
(Indication to traffic joining that road)

Item	
1	Regulations: 42
2	Directions: 19, 31
3	Diagrams: 7001
4	Permitted variants: None
5	Illumination requirements: Schedule 17, item 3

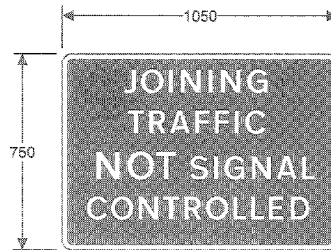

7022  
Traffic joining a length of road being controlled by portable light signals is not controlled by such signals

Item	
1	Regulations: 42
2	Directions: 19, 31
3	Diagrams: 562
4	Permitted variants: None
5	Illumination requirements: Schedule 17, item 3

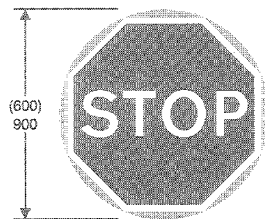

7023  
Vehicular traffic must not proceed into a length of road where one-way working is temporarily necessary  
(Manually operated sign)

Item	
1	Regulations: 10(1), 49(6)
2	Directions: 31, 34(1)
3	Diagrams: 7011, 7024
4	Permitted variants: None
5	Illumination requirements: Schedule 17, item 5

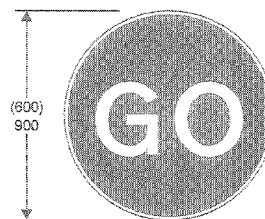

7024  
Vehicular traffic may proceed into a length of road where one-way working is temporarily necessary  
(Manually operated sign)

Item	
1	Regulations: 49(6)
2	Directions: 31, 34(1)
3	Diagrams: 7023
4	Permitted variants: None
5	Illumination requirements: Schedule 17, item 5

**Status:** This is the original version (as it was originally made). This item of legislation is currently only available in its original format.

## PART II

### ROAD WORKS DELINEATORS AND BARRIERS

#### SCHEDULE 12 PART II ROAD WORKS DELINEATORS AND BARRIERS

Regulation 11(1)

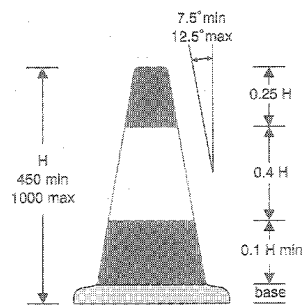

Item	
1	Regulations: 44(1), 44(2)
2	Directions: 31, 37
3	Diagrams: None
4	Permitted variants: None
5	Illumination requirements: Schedule 17, item 16

7101  
Edge of a route for vehicular traffic through or past a temporary obstruction (Traffic cone)

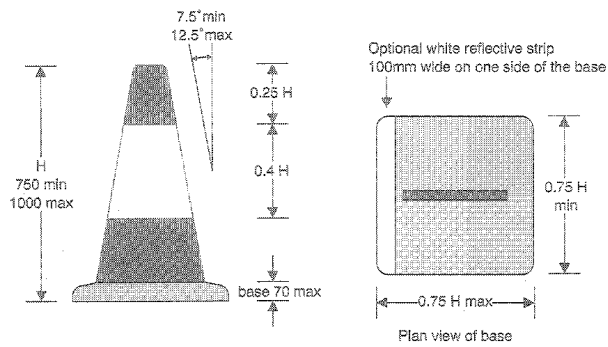

7102  
Edge of a route for vehicular traffic through or past a temporary obstruction on a motorway or dual carriageway road (Flat traffic delineator)

Item	
1	Regulations: 11(2), 44(3)
2	Directions: 31, 37
3	Diagrams: None
4	Permitted variants: None
5	Illumination requirements: Schedule 17, item 18

**Status:** This is the original version (as it was originally made). This item of legislation is currently only available in its original format.

SCHEDULE 12 PART II ROAD WORKS DELINEATORS AND BARRIERS (contd.)

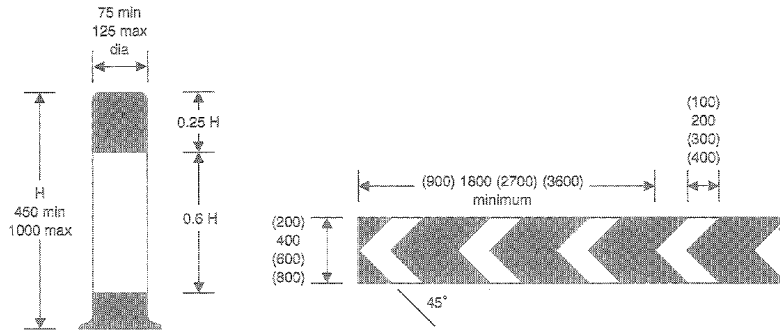

7103

Line of division of traffic flows on one carriageway, or to indicate the edge of a route for vehicular traffic through or past a temporary obstruction, or to mark a boundary between two carriageways of a dual carriageway which may not be crossed except for fire brigade, ambulance or police purposes (Traffic cylinder)

Item	
1	Regulations: 44(4)
2	Directions: 31, 37
3	Diagrams: None
4	Permitted variants: None
5	Illumination requirements: Schedule 17, item 16

7104

Sharp deviation of route to the left at or near road works or other temporary obstructions

Item	
1	Regulations: None
2	Directions: 31, 36, 37
3	Diagrams: None
4	Permitted variants: Schedule 16, item 13
5	Illumination requirements: Schedule 17, item 4

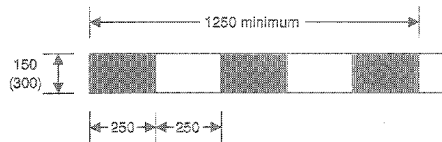

7105

Position of barrier to mark length of road closed to traffic or to guide traffic past an obstruction

Item	
1	Regulations: 42
2	Directions: 31, 36, 37
3	Diagrams: None
4	Permitted variants: None
5	Illumination requirements: Schedule 17, item 4

Status: This is the original version (as it was originally made). This item of legislation is currently only available in its original format.

## PART III

### SIGNS FOR LANE CLOSURES AND CONTRA-FLOW WORKING AT ROAD WORKS

#### SCHEDULE 12 PART III SIGNS FOR LANE CLOSURES AND CONTRA-FLOW WORKING AT ROAD WORKS

Regulation 11(1)

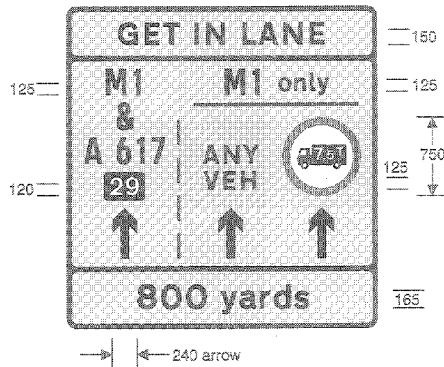

7201

Restrictions ahead on motorway owing to road works

Item	
1	Regulations: 12(8)
2	Directions: 7, 31
3	Diagrams: See table of combinations
4	Permitted variants: Schedule 16, items 16, 41
5	Illumination requirements: Schedule 17, item 1

Table of combinations

Item 1	Top panel:	None	7262	7263	7264
Item 2	Bottom panels	7270 7273 7275 None	7270 7271	7271 7276 None	7271 7273 7275 None

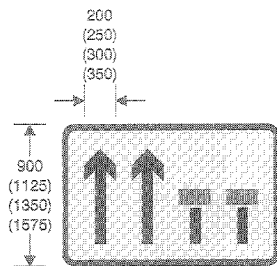

7202

Right hand two lanes of a four lane dual carriageway closed to traffic ahead

Item	
1	Regulations: 12(8)
2	Directions: 19, 31
3	Diagrams: 7208
4	Permitted variants: Schedule 16, item 16
5	Illumination requirements: Schedule 17, item 1

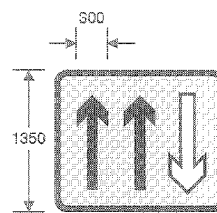

7203

Two lanes of carriageway open with off side contra-flow working

Item	
1	Regulations: 12(8)
2	Directions: 19, 31
3	Diagrams: 7209
4	Permitted variants: Schedule 16, item 16
5	Illumination requirements: Schedule 17, item 1

**Status:** This is the original version (as it was originally made). This item of legislation is currently only available in its original format.

SCHEDULE 12 PART III SIGNS FOR LANE CLOSURES AND CONTRA-FLOW WORKING AT ROAD WORKS (contd.)

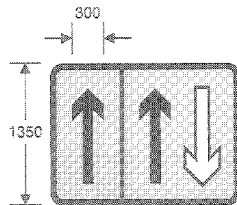

7203.1

Two lanes open to traffic, one of which uses the hard shoulder, with off side contra-flow working

Item	
1	Regulations: 12(8)
2	Directions: 7, 19, 31
3	Diagrams: 7209
4	Permitted variants: Schedule 16, item 16
5	Illumination requirements: Schedule 17, item 1

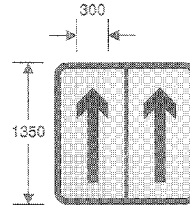

7204

Two lanes open to traffic one of which uses the hard shoulder

Item	
1	Regulations: 12(8)
2	Directions: 7, 19, 31
3	Diagrams: 7209
4	Permitted variants: Schedule 16, item 16
5	Illumination requirements: Schedule 17, item 1

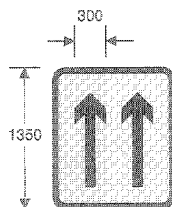

7205

Two lanes of carriageway open ahead

Item	
1	Regulations: 12(8)
2	Directions: 19, 31
3	Diagrams: 7209
4	Permitted variants: Schedule 16, item 16
5	Illumination requirements: Schedule 17, item 1

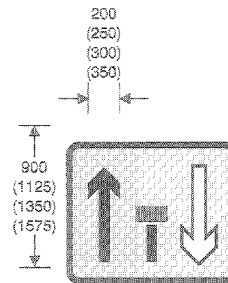

7206

Centre lane of a three lane single carriageway road closed with traffic on the off side of the works travelling in the opposite direction

Item	
1	Regulations: 12(8)
2	Directions: 19, 31
3	Diagrams: 7209
4	Permitted variants: Schedule 16, item 16
5	Illumination requirements: Schedule 17, item 1

**Status:** This is the original version (as it was originally made). This item of legislation is currently only available in its original format.

SCHEDULE 12 PART III SIGNS FOR LANE CLOSURES AND CONTRA-FLOW WORKING AT ROAD WORKS (contd.)

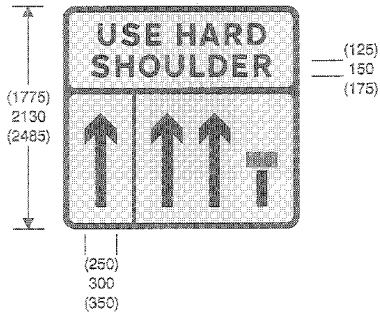

Item	
1	Regulations: 12(3)
2	Directions: 7, 19, 31
3	Diagrams: 7208
4	Permitted variants: Schedule 16, item 16
5	Illumination requirements: Schedule 17, item 1

7207

Right hand lane of a three lane dual carriageway closed ahead, traffic may use left hand lanes and hard shoulder now

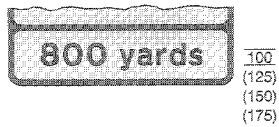

7208

Distance ahead at which conditions indicated by signs shown in the diagrams in item 3 of the table start to apply

Item	
1	Regulations: None
2	Directions: 19, 31
3	Diagrams: 7202, 7206, 7207
4	Permitted variants: Schedule 16, item 6 The legend may be on two lines
5	Illumination requirements: Schedule 17, item 8



7209

Distance over which conditions indicated by signs shown in the diagrams in item 3 of the table will apply

Item	
1	Regulations: None
2	Directions: 19, 31
3	Diagrams: 7203, 7203.1, 7204, 7205
4	Permitted variants: Schedule 16, item 6 The legend may be on one line
5	Illumination requirements: Schedule 17, item 8



**Status:** This is the original version (as it was originally made). This item of legislation is currently only available in its original format.

SCHEDULE 12 PART III SIGNS FOR LANE CLOSURES AND CONTRA-FLOW WORKING AT ROAD WORKS (contd.)

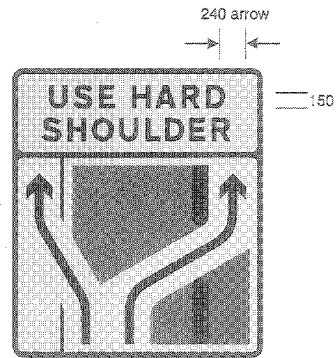
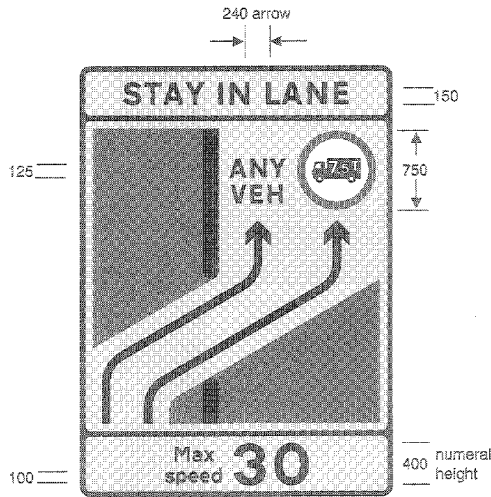

7210  
Diversion of two traffic lanes to the other carriageway, with heavy goods vehicles prohibited from the right hand lane

Item	
1	Regulations: 12(8)
2	Directions: 7, 31
3	Diagrams: See table of combinations
4	Permitted variants: Schedule 16, items 16, 41
5	Illumination requirements: Schedule 17, item 1

Table of combinations

Item 1	Top panel	None	7263	7264
Item 2	Bottom panels	7271	7271	7271
		7275	7274	7275
		None	7275	None
		None	None	None

7211  
Diversion of the two lanes open to traffic; the left hand lane uses the hard shoulder, and the right hand lane goes to the other carriageway

Item	
1	Regulations: 12(8)
2	Directions: 7, 31
3	Diagrams: See table of combinations
4	Permitted variants: Schedule 16, items 16, 41
5	Illumination requirements: Schedule 17, item 1

Table of combinations

Item 1	Top panel	None	7260	7262	7263	7264
Item 2	Bottom panels	7271	7272	7271	7271	7271
			7274			
			7275			
			None			

Status: This is the original version (as it was originally made). This item of legislation is currently only available in its original format.

SCHEDULE 12 PART III SIGNS FOR LANE CLOSURES AND CONTRA-FLOW WORKING AT ROAD WORKS (contd.)

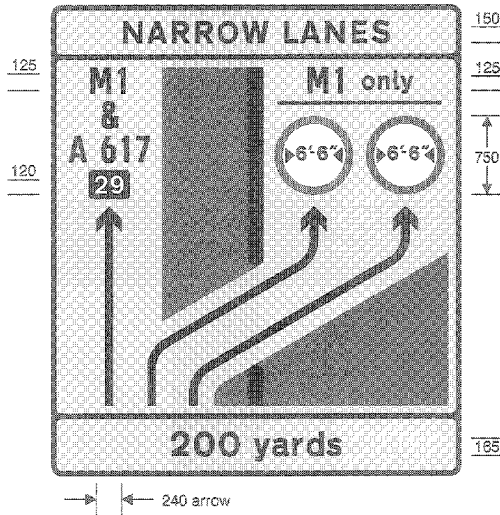

7212  
Diversion of two right hand lanes of three lanes open to traffic to the other carriageway of a motorway; vehicles over 6' 6" wide are prohibited from the two right hand lanes

Item	
1	Regulations: 12(8)
2	Directions: 7, 13(1), 31
3	Diagrams: See table of combinations
4	Permitted variants: Schedule 16, items 16, 41
5	Illumination requirements: Schedule 17, item 1

Table of combinations

Item 1	Top panel:	None	7262	7263	7264
Item 2	Bottom panels:	7271 7272 7275 None	7271	7271 7272 7274 7275 None	7271 7272 7275 None

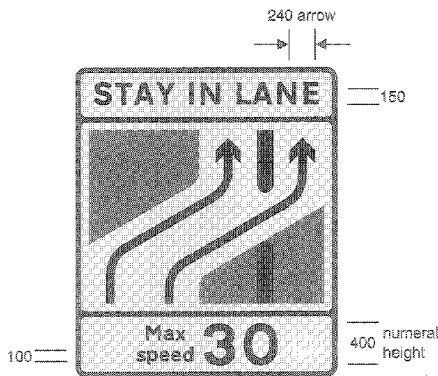

7213  
Diversion of two lanes open to traffic; the left hand lane moves to the right hand side of the carriageway, and the right hand lane goes to the other carriageway

Item	
1	Regulations: 12(8)
2	Directions: 7, 31
3	Diagrams: See table of combinations
4	Permitted variants: Schedule 16, items 16, 41
5	Illumination requirements: Schedule 17, item 1

Table of combinations

Item 1	Top panel:	None	7262	7263	7264
Item 2	Bottom panels:	7271 7272 7275 None	7271	7271 7272 7274 7275 None	7271 7272 7275 None

**Status:** This is the original version (as it was originally made). This item of legislation is currently only available in its original format.

SCHEDULE 12 PART III SIGNS FOR LANE CLOSURES AND CONTRA-FLOW WORKING AT ROAD WORKS (contd.)

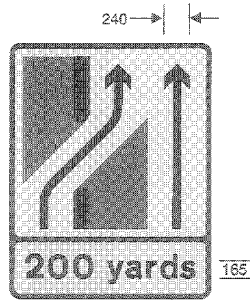

7214

Diversion of left hand lane from original carriageway to join right hand lane already diverted to the other carriageway

Item	
1	Regulations: 12(8)
2	Directions: 7, 31
3	Diagrams: See table of combinations
4	Permitted variants: Schedule 16, items 16, 41
5	Illumination requirements: Schedule 17, item 1

Table of combinations

Item 1	Top panel	None	7263	7264
Item 2	Bottom panels	7271	7271	7271
		7272	7272	7272
		7275	7274	7275
		None	7275	None
		None	None	None

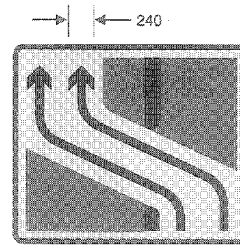

7215

Two lanes open to traffic return to original carriageway

Item	
1	Regulations: 12(8)
2	Directions: 7, 31
3	Diagrams: See table of combinations
4	Permitted variants: Schedule 16, items 16, 41
5	Illumination requirements: Schedule 17, item 1

Table of combinations

Item 1	Top panel	None	7263	7264
Item 2	Bottom panels	7271	7271	7271
		7275	7274	7275
		None	7275	None
		None	None	None
		None	None	None

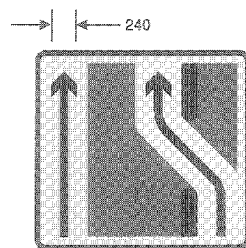

7216

Right hand lane returns to right hand side of original carriageway ahead, but remains separated by works area from left hand lane

Item	
1	Regulations: 12(8)
2	Directions: 7, 31
3	Diagrams: See table of combinations
4	Permitted variants: Schedule 16, items 16, 41
5	Illumination requirements: Schedule 17, item 1

Table of combinations

Item 1	Top panel	None	7263	7264
Item 2	Bottom panels	7271	7271	7271
		7275	7274	7275
		None	7275	None
		None	None	None
		None	None	None

Status: This is the original version (as it was originally made). This item of legislation is currently only available in its original format.

SCHEDULE 12 PART III SIGNS FOR LANE CLOSURES AND CONTRA-FLOW WORKING AT ROAD WORKS (contd.)

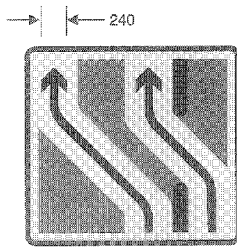

7217

Left hand lane returns from right hand side of original carriageway to left hand side ahead and right hand lane returns from other carriageway to right hand side of original carriageway

Item 1	Regulations: 12(8)
Item 2	Directions: 7, 31
Item 3	Diagrams: See table of combinations
Item 4	Permitted variants: Schedule 16, items 16, 41
Item 5	Illumination requirements: Schedule 17, item 1

Table of combinations

Item 1	Top panel	None	7263	7264
Item 2	Bottom panels	7271	7271	7271
		7275	7274	7275
		None	7275	None

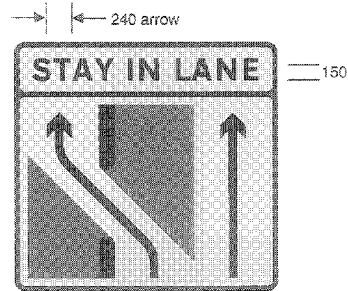

7218

Left hand lane returns from other carriageway to original carriageway ahead; right hand lane continues on other carriageway

Item 1	Regulations: 12(8)
Item 2	Directions: 7, 31
Item 3	Diagrams: See table of combinations
Item 4	Permitted variants: Schedule 16, items 16, 41
Item 5	Illumination requirements: Schedule 17, item 1

Table of combinations

Item 1	Top panel	None	7262	7263	7264
Item 2	Bottom panels	7271	7271	7271	7271
		7272	7271	7272	7272
		7275	7274	7274	7275
		None	7275	None	None

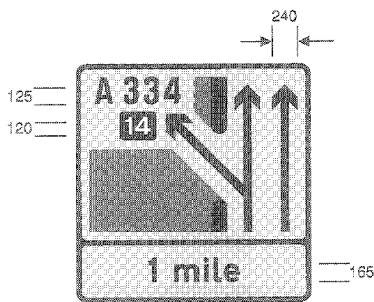

7220

Destinations reached from a junction where traffic is in contra-flow on other carriageway of a motorway

Item 1	Regulations: 12(8)
Item 2	Directions: 7, 13(1), 31
Item 3	Diagrams: See table of combinations
Item 4	Permitted variants: Schedule 16, items 16, 20, 41 Place names may be added to the route number.
Item 5	Illumination requirements: Schedule 17, item 1

Table of combinations

Item 1	Top panel	None
Item 2	Bottom panels	7270
		7271
		None

**Status:** This is the original version (as it was originally made). This item of legislation is currently only available in its original format.

SCHEDULE 12 PART III SIGNS FOR LANE CLOSURES AND CONTRA-FLOW WORKING AT ROAD WORKS (contd.)

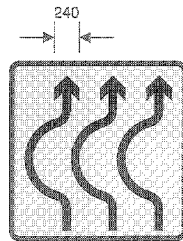

7221

Sharp bends ahead where traffic is diverted onto a temporary road for a short distance

Item	
1	Regulations: 12(6)
2	Directions: 31
3	Diagrams: See table of combinations
4	Permitted variants: Schedule 16, items 16, 28, 41
5	Illumination requirements: Schedule 17, item 1

Table of combinations

Item 1	Top panel	None	7262	7263	7264
Item 2	Bottom panels	7271 7275 None	7271	7271 7274 7275 None	7271 7275 None

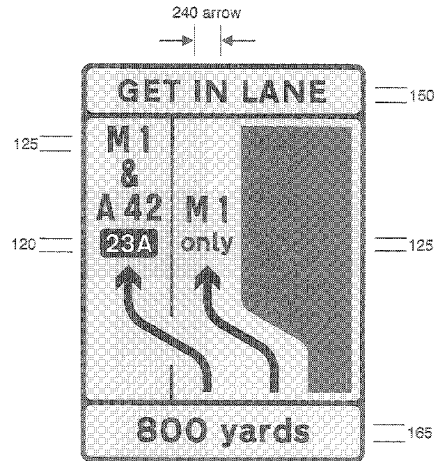

7230

Diversion of traffic from left and centre lanes of a motorway carriageway to use hard shoulder and left hand lane; hard shoulder is to be used by traffic leaving at the junction specified

Item	
1	Regulations: 12(6)
2	Directions: 7, 13(1), 31
3	Diagrams: See table of combinations
4	Permitted variants: Schedule 16, items 16, 41
5	Illumination requirements: Schedule 17, item 1

Table of combinations

Item 1	Top panel	None	7260	7262	7263	7264
Item 2	Bottom panels	7271	7272 7274 7275 None	7271	7271	7271

**Status:** This is the original version (as it was originally made). This item of legislation is currently only available in its original format.

SCHEDULE 12 PART III SIGNS FOR LANE CLOSURES AND CONTRA-FLOW WORKING AT ROAD WORKS (contd.)

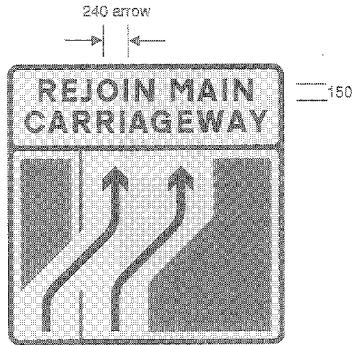

7231

Return of traffic from hard shoulder and left lane of carriageway to left and centre lanes

Item	
1	Regulations: 12(8)
2	Directions: 7, 31
3	Diagrams: See table of combinations
4	Permitted variants: Schedule 16, items 16, 41
5	Illumination requirements: Schedule 17, item 1

Table of combinations

Item 1	Top panel	None	7261	7262	7263	7284
Item 2	Bottom panels	7271	7272 7274 7275 None	7271	7271	7271

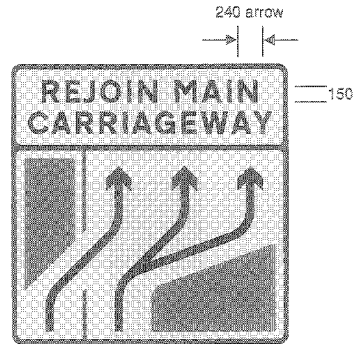

7232

Return of traffic from hard shoulder and left lane of carriageway to use three lanes

Item	
1	Regulations: 12(8)
2	Directions: 7, 31
3	Diagrams: See table of combinations
4	Permitted variants: Schedule 16, items 16, 41
5	Illumination requirements: Schedule 17, item 1

Table of combinations

Item 1	Top panel	None	7261
Item 2	Bottom panels	7271	7272 7275 None

**Status:** This is the original version (as it was originally made). This item of legislation is currently only available in its original format.

SCHEDULE 12 PART III SIGNS FOR LANE CLOSURES AND CONTRA-FLOW WORKING AT ROAD WORKS (contd.)

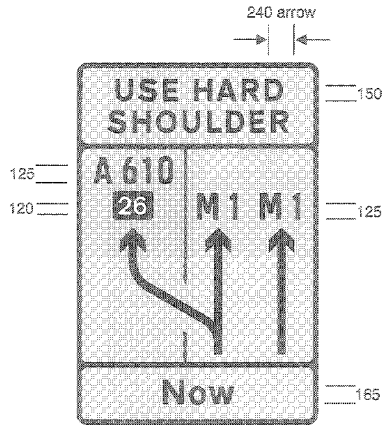

7233  
Traffic from left hand lane of carriageway of a motorway to use hard shoulder to leave at junction ahead

Item	
1	Regulations: 12(8)
2	Directions: 7, 13(1), 31
3	Diagrams: See table of combinations
4	Permitted variants: Schedule 16, items 16, 20, 41
5	Illumination requirements: Schedule 17, item 1

Table of combinations

Item 1	Top panel	None	7260
Item 2	Bottom panels	7271	7272 None

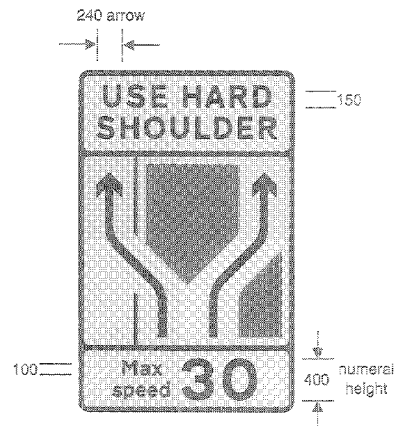

7234  
Traffic from left hand lane to use hard shoulder ahead; traffic from centre lane to move to right hand side of carriageway

Item	
1	Regulations: 12(8)
2	Directions: 7, 31
3	Diagrams: See table of combinations
4	Permitted variants: Schedule 16, items 16, 41
5	Illumination requirements: Schedule 17, item 1

Table of combinations

Item 1	Top panel	None	7260	7262	7263	7264
Item 2	Bottom panels	7271	7272 7274 7275 None	7271	7271	7271

Status: This is the original version (as it was originally made). This item of legislation is currently only available in its original format.

SCHEDULE 12 PART III SIGNS FOR LANE CLOSURES AND CONTRA-FLOW WORKING AT ROAD WORKS (contd.)

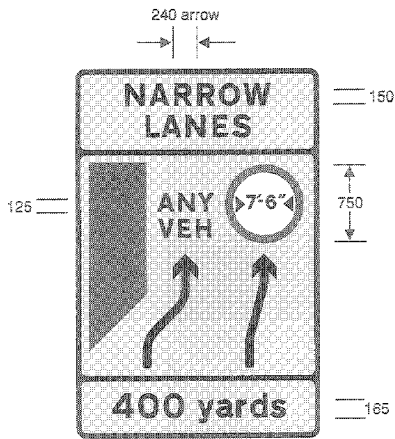

7235  
Lanes ahead are narrower than normal: wide vehicles are prohibited from the right hand lane

Item	
1	Regulations: 12(8)
2	Directions: 31
3	Diagrams: See table of combinations
4	Permitted variants: Schedule 16, items 16, 41
5	Illumination requirements: Schedule 17, item 1

Table of combinations

Item 1	Top panel	7264
Item 2	Bottom panels	7271 None

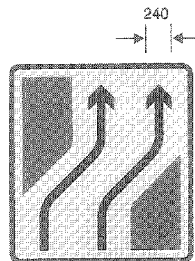

7237  
Diversion of traffic from left and centre lanes to centre and right hand lanes

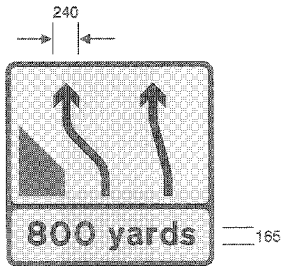

7236  
Lanes return to normal width

Item	
1	Regulations: 12(8)
2	Directions: 31
3	Diagrams: See table of combinations
4	Permitted variants: Schedule 16, items 16, 41
5	Illumination requirements: Schedule 17, item 1

Table of combinations

Item 1	Top panel	None
Item 2	Bottom panels	7271 None

Item	
1	Regulations: 12(6)
2	Directions: 31
3	Diagrams: See table of combinations
4	Permitted variants: Schedule 16, items 16, 41
5	Illumination requirements: Schedule 17, item 1

Table of combinations

Item 1	Top panel	None	7263	7264
Item 2	Bottom panels	7271 7275 None	7271 7274 7275 None	7271 7275 None



**Status:** This is the original version (as it was originally made). This item of legislation is currently only available in its original format.

SCHEDULE 12 PART III SIGNS FOR LANE CLOSURES AND CONTRA-FLOW WORKING AT ROAD WORKS (contd.)

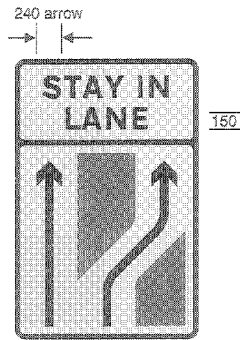

7238  
 Diversion of traffic from centre lane to right hand lane; traffic in the left hand lane is unaffected

Item	
1	Regulations: 12(8)
2	Directions: 3†
3	Diagrams: See table of combinations
4	Permitted variants: Schedule 16, items 16, 41
5	Illumination requirements: Schedule 17, item 1

Table of combinations

Item 1	Top panel	None	7262	7265	7264
Item 2	Bottom panels	7271	7271	7271	7271
		7272		7272	7272
		7275		7274	7275
		None		7275	None

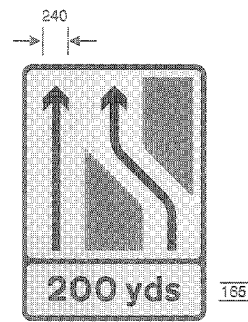

7239  
 Traffic diverted into right hand lane to rejoin centre lane

Item	
1	Regulations: 12(8)
2	Directions: 3†
3	Diagrams: See table of combinations
4	Permitted variants: Schedule 16, items 16, 41
5	Illumination requirements: Schedule 17, item 1

Table of combinations

Item 1	Top panel	None	7263	7264
Item 2	Bottom panels	7271	7271	7271
		7272	7272	7272
		7275	7274	7275
		None	7275	None

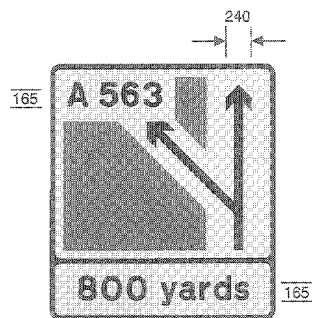

7240  
 Destination reached from a junction where permanent sign is obscured by presence of road works on an all-purpose road

Item	
1	Regulations: 12(3)
2	Directions: 12(3), 3†
3	Diagrams: See table of combinations
4	Permitted variants: Schedule 16, items 16, 20, 41
5	Illumination requirements: Schedule 17, item 1

Table of combinations

Item 1	Top panel	None
Item 2	Bottom panels	7270
		7271

**Status:** This is the original version (as it was originally made). This item of legislation is currently only available in its original format.

SCHEDULE 12 PART III SIGNS FOR LANE CLOSURES AND CONTRA-FLOW WORKING AT ROAD WORKS (contd.)

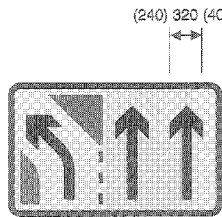

7250  
Near side traffic lane diverges from main carriageway at a junction as part of temporary traffic management scheme

Item	
1	Regulations: 12(8)
2	Directions: 19, 31
3	Diagrams: 7256
4	Permitted variants: Schedule 16, item 16
5	Illumination requirements: Schedule 17, item 1

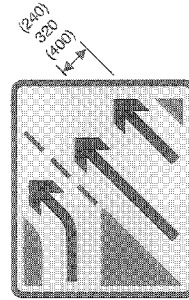

7251  
Additional traffic lanes joining from the right at a junction as part of temporary traffic management scheme

Item	
1	Regulations: 12(8)
2	Directions: 19, 31
3	Diagrams: 7256
4	Permitted variants: Schedule 16, item 16
5	Illumination requirements: Schedule 17, item 1

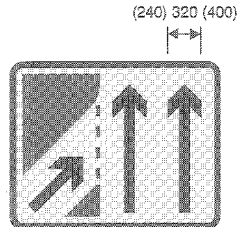

7252  
Traffic joining from the left at a junction as part of temporary traffic management scheme. Traffic on the main carriageway has priority

Item	
1	Regulations: 12(8)
2	Directions: 19, 31
3	Diagrams: 7256
4	Permitted variants: Schedule 16, item 16
5	Illumination requirements: Schedule 17, item 1

**Status:** This is the original version (as it was originally made). This item of legislation is currently only available in its original format.

SCHEDULE 12 PART III SIGNS FOR LANE CLOSURES AND CONTRA-FLOW WORKING AT ROAD WORKS (contd.)

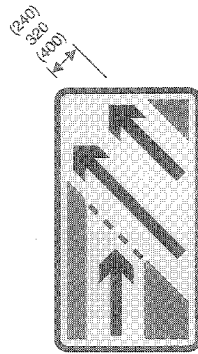

7253

Traffic joining main carriageway at a junction as part of temporary traffic management scheme; traffic on the main carriageway has priority

Item	
1	Regulations: 12(8)
2	Directions: 19, 31
3	Diagrams: 7256
4	Permitted variants: Schedule 16, item 16
5	Illumination requirements: Schedule 17, item 1

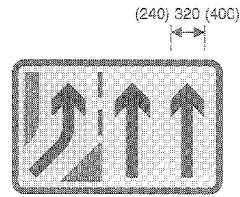

7254

Additional traffic lane joining from the left at a junction as part of temporary traffic management scheme

Item	
1	Regulations: 12(8)
2	Directions: 19, 31
3	Diagrams: 7256
4	Permitted variants: Schedule 16, item 16
5	Illumination requirements: Schedule 17, item 1

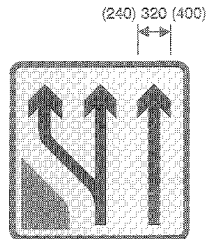

7255

Additional traffic lane available at a junction as part of temporary traffic management scheme

Item	
1	Regulations: 12(8)
2	Directions: 19, 31
3	Diagrams: 7256
4	Permitted variants: Schedule 16, item 16
5	Illumination requirements: Schedule 17, item 1

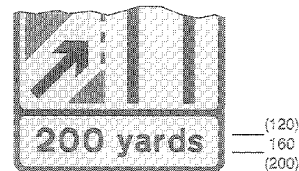

7256

Distance ahead at which the change in road layout occurs

Item	
1	Regulations: 12(8)
2	Directions: 19, 31
3	Directions: 7250, 7251, 7252, 7253, 7254, 7255
4	Permitted variants: Schedule 16, item 6
5	Illumination requirements: Schedule 17, item 6

**Status:** This is the original version (as it was originally made). This item of legislation is currently only available in its original format.

SCHEDULE 12 PART III SIGNS FOR LANE CLOSURES AND CONTRA-FLOW WORKING AT ROAD WORKS (contd.)

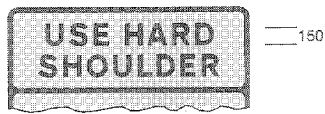

7260  
Panel to appear at top of road works sign allowing traffic to use hard shoulder as indicated on main part of sign

Item	
1	Regulations: None
2	Directions: 7, 31
3	Diagrams: 7211, 7230, 7233, 7234
4	Permitted variants: Legend may be shown on one line
5	Illumination requirements: Schedule 17, item 1



7261  
Panel to appear at top of road works sign instructing traffic using hard shoulder to rejoin main carriageway

Item	
1	Regulations: None
2	Directions: 7, 31
3	Diagrams: 7231, 7232
4	Permitted variants: Legend may be shown on one line
5	Illumination requirements: Schedule 17, item 1



7262  
Panel to appear at top of road works sign instructing traffic to get into the appropriate lane as indicated on main part of sign

Item	
1	Regulations: None
2	Directions: 7, 31
3	Diagrams: 7201, 7211, 7212, 7213, 7218, 7221, 7230, 7231, 7234, 7235
4	Permitted variants: Legend may be shown on two lines
5	Illumination requirements: Schedule 17, item 1



7263  
Panel to appear at top of road works sign instructing traffic to remain in appropriate lane

Item	
1	Regulations: None
2	Directions: 7, 31
3	Diagrams: 7201, 7210, 7211, 7212, 7213, 7214, 7215, 7216, 7217, 7218, 7221, 7230, 7231, 7234, 7237, 7238, 7239
4	Permitted variants: Legend may be shown on one line
5	Illumination requirements: Schedule 17, item 1

**Status:** This is the original version (as it was originally made). This item of legislation is currently only available in its original format.

SCHEDULE 12 PART III SIGNS FOR LANE CLOSURES AND  
CONTRA-FLOW WORKING AT ROAD WORKS (contd.)



7264

Panel to appear at top of road works sign indicating that traffic lanes are narrower than normal

Item	
1	Regulations: None
2	Directions: 31
3	Diagrams: 7201, 7210, 7211, 7212, 7213, 7214, 7215, 7216, 7217, 7218, 7221, 7230, 7231, 7234, 7235, 7237, 7238, 7239
4	Permitted variants: Legend may be shown on one line
5	Illumination requirements: Schedule 17, item 1

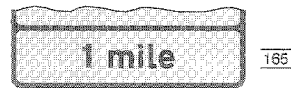

7270

Panel to appear at bottom of road works sign indicating distance in miles to junction indicated on signs shown in diagrams in item 3 of the table

Item	
1	Regulations: None
2	Directions: 31
3	Diagrams: 7201, 7220, 7240
4	Permitted variants: "1 mile" may be varied to "2/3 mile"
5	Illumination requirements: Schedule 17, item 1

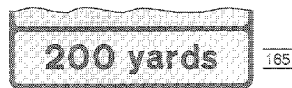

7271

Panel to appear at bottom of road works sign indicating distance in yards to point at which condition indicated by signs shown in diagrams in item 3 of the table start to apply

Item	
1	Regulations: None
2	Directions: 31
3	Diagrams: 7201, 7210, 7211, 7212, 7213, 7214, 7215, 7216, 7217, 7218, 7220, 7221, 7230, 7231, 7232, 7233, 7234, 7235, 7236, 7237, 7238, 7239, 7240
4	Permitted variants: Schedule 16, item 11 "200" may be varied to the appropriate distance to the nearest 50 yards. The legend may be on two lines. "yards" may be varied to "yds"
5	Illumination requirements: Schedule 17, item 1



7272

Panel to appear at bottom of road works sign indicating that the change to the road layout indicated by sign shown in diagrams in item 3 of the table occurs at that point

Item	
1	Regulations: None
2	Directions: 31
3	Diagrams: 7211, 7212, 7213, 7214, 7215, 7216, 7230, 7231, 7232, 7233, 7234, 7238, 7239
4	Permitted variants: None
5	Illumination requirements: Schedule 17, item 1

Status: This is the original version (as it was originally made). This item of legislation is currently only available in its original format.

SCHEDULE 12 PART III SIGNS FOR LANE CLOSURES AND CONTRA-FLOW WORKING AT ROAD WORKS (contd.)



7273  
Panel to appear at bottom of road works sign indicating distance over which conditions indicated by sign shown in the diagram in item 3 of the table will apply

7274  
Panel to appear at bottom of road works sign indicating that traffic lanes are narrower than normal

Item	
1	Regulations: None
2	Directions: 31
3	Diagrams: 7201
4	Permitted variants: Schedule 16, item 5 Legend may be shown on one line
5	Illumination requirements: Schedule 17, item 1

Item	
1	Regulations: None
2	Directions: 31
3	Diagrams: 7210, 7211, 7212, 7213, 7214, 7215, 7216, 7217, 7218, 7221, 7230, 7231, 7234, 7237, 7238, 7239
4	Permitted variants: Legend may be shown on one line
5	Illumination requirements: Schedule 17, item 1

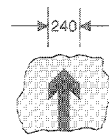
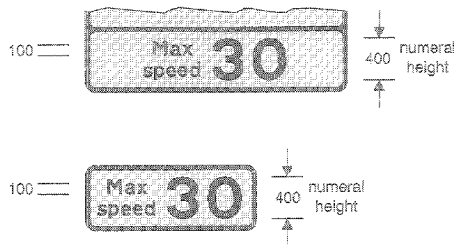

7275  
Advisory temporary maximum speed (Alternative types)

7280  
Symbol that may be incorporated into a road works sign to indicate a lane open to traffic

Item	
1	Regulations: None
2	Directions: 31
3	Diagrams: 7201, 7210, 7211, 7212, 7213, 7214, 7215, 7216, 7217, 7218, 7221, 7230, 7231, 7232, 7233, 7234, 7235, 7238, 7237, 7238, 7239
4	Permitted variants: Schedule 16, item 1
5	Illumination requirements: Schedule 17, item 1

Item	
1	Regulations: None
2	Directions: 31
3	Diagrams: 7201, 7210, 7211, 7212, 7213, 7214, 7215, 7216, 7217, 7218, 7220, 7221, 7230, 7231, 7232, 7233, 7234, 7235, 7238, 7237, 7238, 7239, 7240
4	Permitted variants: None
5	Illumination requirements: Not applicable

**Status:** This is the original version (as it was originally made). This item of legislation is currently only available in its original format.

SCHEDULE 12 PART III SIGNS FOR LANE CLOSURES AND CONTRA-FLOW WORKING AT ROAD WORKS (contd.)



7281  
Symbol that may be incorporated into a road works sign to indicate a lane open to any vehicle

Item	
1	Regulations: None
2	Directions: 31
3	Diagrams: Same as 7280
4	Permitted variants: None
5	Illumination requirements: Not applicable

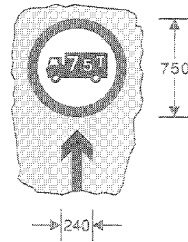

7282  
Symbol that may be incorporated into a road works sign to indicate a lane subject to a temporary prohibition on goods vehicles exceeding the maximum gross weight shown

Item	
1	Regulations: None
2	Directions: 7, 31
3	Diagrams: Same as 7280
4	Permitted variants: Same as diagram 622.1A
5	Illumination requirements: Not applicable

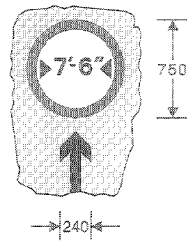

7283  
Symbol that may be incorporated into a road works sign to indicate a lane subject to a temporary width restriction

Item	
1	Regulations: None
2	Directions: 7, 31
3	Diagrams: Same as 7280
4	Permitted variants: Schedule 16, item 1
5	Illumination requirements: Not applicable

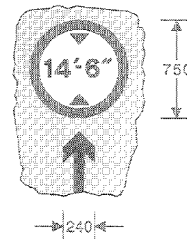

7284  
Symbol that may be incorporated into a road works sign to indicate a lane subject to a temporary height restriction

Item	
1	Regulations: None
2	Directions: 7, 31
3	Diagrams: Same as 7280
4	Permitted variants: Schedule 16, item 1 The height limit roundel may be varied to the one shown in diagram 629.2A
5	Illumination requirements: Not applicable

Status: This is the original version (as it was originally made). This item of legislation is currently only available in its original format.

SCHEDULE 12 PART III SIGNS FOR LANE CLOSURES AND CONTRA-FLOW WORKING AT ROAD WORKS (contd.)

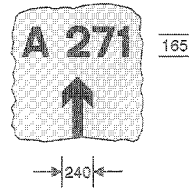

7285  
Symbol that may be incorporated into a road works sign on an all-purpose road to indicate that a lane leads to a particular destination

Item	
1	Regulations: None
2	Directions: 31
3	Diagrams: Same as 7280
4	Permitted variants: Schedule 16, item 23 Place names may be added to or substituted for the route number. The angle of the arrow may be varied to point at 45° upwards to the left
5	Illumination requirements: Not applicable

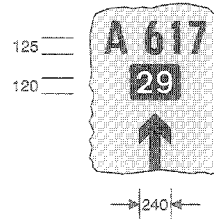

7286  
Symbol that may be incorporated into a road works sign on a motorway to indicate that a lane leads to a particular destination at the junction shown

Item	
1	Regulations: None
2	Directions: 31
3	Diagrams: Same as 7280
4	Permitted variants: Schedule 16, item 23 Same as 7285. The angle of the arrow may be varied to 45° pointing upwards to the left
5	Illumination requirements: Not applicable

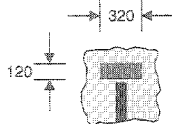

7287  
Symbol that may be incorporated into a road works sign to indicate a lane is closed

Item	
1	Regulations: None
2	Directions: 31
3	Diagrams: 7201
4	Permitted variants: None
5	Illumination requirements: Not applicable

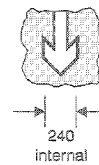

7288  
Symbol that may be incorporated into a road works sign to indicate that traffic is moving in the opposite direction to traffic in other lanes which are segregated

Item	
1	Regulations: None
2	Directions: 31
3	Diagrams: 7201, 7214, 7218
4	Permitted variants: None
5	Illumination requirements: Not applicable



**Status:** This is the original version (as it was originally made). This item of legislation is currently only available in its original format.

SCHEDULE 12 PART III SIGNS FOR LANE CLOSURES AND  
CONTRA-FLOW WORKING AT ROAD WORKS (contd.)

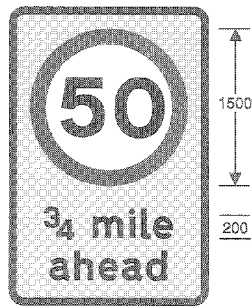

7290  
Mandatory speed limit ahead at road works

Item:	
1	Regulations: None
2	Directions: 7, 31
3	Diagrams: None
4	Permitted variants: Schedule 16, item 1 The distance legend may be shown on one line and "m" substituted for "mile"
5	Illumination requirements: Schedule 17, item 1

Status: This is the original version (as it was originally made). This item of legislation is currently only available in its original format.

## PART IV

### SIGNS FOR ROAD WORKS ENTRANCES AND EXITS

#### SCHEDULE 12 PART IV SIGNS FOR ROAD WORKS ENTRANCES AND EXITS

Regulation 11(1)

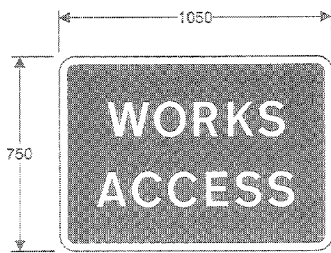

**7301**  
Temporary access to a construction or road works site

Item	
1	Regulations: None
2	Directions: 31
3	Diagrams: 506.1
4	Permitted variants: "WORKS ACCESS" may be varied to "WORKS TRAFFIC ONLY" or "NO WORKS TRAFFIC"
5	Illumination requirements: Schedule 17, item 4

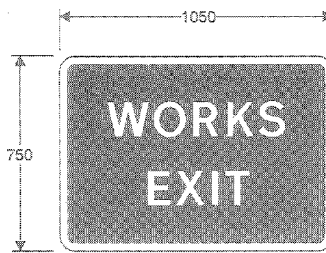

**7302**  
Temporary exit from a construction or road works site

Item	
1	Regulations: None
2	Directions: 31
3	Diagrams: 506.1
4	Permitted variants: None
5	Illumination requirements: Schedule 17, item 4

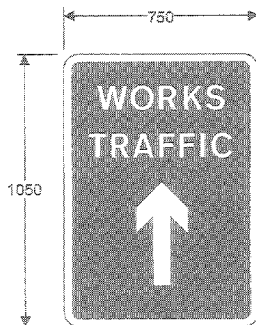

**7303**  
Direction to be taken by road works or construction traffic at a junction ahead

Item	
1	Regulations: None
2	Directions: 31
3	Diagrams: None
4	Permitted variants: Schedule 16, item 12
5	Illumination requirements: Schedule 17, item 4

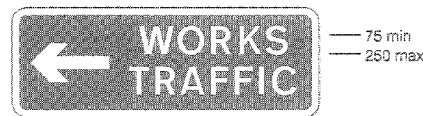

**7304**  
Direction to be taken by road works or construction traffic at a junction or works entrance ahead

Item	
1	Regulations: None
2	Directions: 31
3	Diagrams: None
4	Permitted variants: Schedule 16, item 12
5	Illumination requirements: Schedule 17, item 4

**Status:** This is the original version (as it was originally made). This item of legislation is currently only available in its original format.

SCHEDULE 12 PART IV SIGNS FOR ROAD WORKS ENTRANCES AND EXITS (contd.)

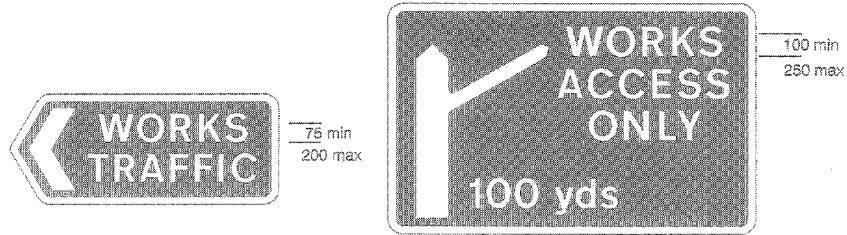

7305  
Direction to be taken by road works or construction traffic at a junction or works entrance

item	
1	Regulations: None
2	Directions: S1
3	Diagrams: None
4	Permitted variants: Schedule 16, item 15
5	Illumination requirements: Schedule 17, item 4

7306  
Direction to be taken by road works or construction traffic to an access to a works site ahead

item	
1	Regulations: None
2	Directions: S1
3	Diagrams: None
4	Permitted variants: Schedule 16, items 8, 16
5	Illumination requirements: Schedule 17, item 4

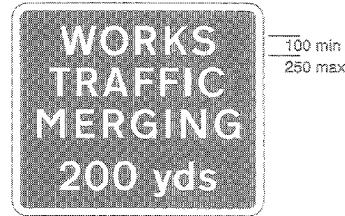

7307  
Exit from a works site ahead

item	
1	Regulations: None
2	Directions: S1
3	Diagrams: None
4	Permitted variants: Schedule 16, item 6
5	Illumination requirements: Schedule 17, item 4

**Status:** This is the original version (as it was originally made). This item of legislation is currently only available in its original format.

## PART V

### SIGNS MOUNTED ON ROAD WORKS VEHICLES

SCHEDULE 12 PART V  
SIGNS MOUNTED ON ROAD WORKS VEHICLES

Regulation 11(1), 14

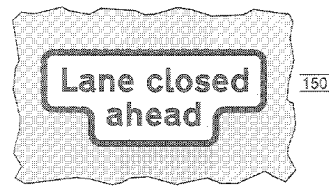
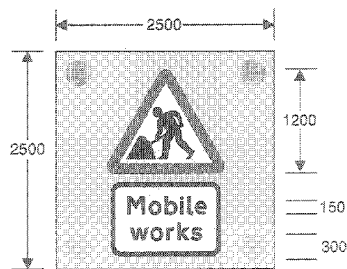

7401.1  
Nature or effect of mobile road works

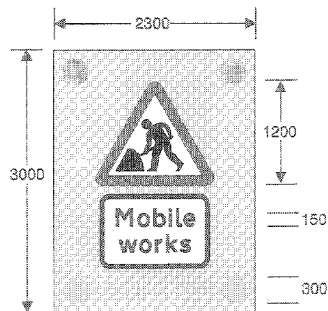

7401  
Mobile road works ahead  
(Alternative types)

Item:	
1	Regulations: 14
2	Directions: 19, 31
3	Diagrams: 7401
4	Permitted variants: "Lane closed ahead" may be varied to: 1. "Surveying" 2. "Line painting" 3. "On hard shoulder" 4. "Weed spraying" 5. "Mobile works" "Lane" may be varied to "Lanes" Legend may be on one line Plate may be rectangular
5	Illumination requirements: Schedule 17, item 6

Item	
1	Regulations: 14
2	Directions: 19, 31
3	Diagrams: None
4	Permitted variants: See diagram 7401.1
5	Illumination requirements: Schedule 17, item 6

**Status:** This is the original version (as it was originally made). This item of legislation is currently only available in its original format.

SCHEDULE 12 PART V SIGNS MOUNTED ON ROAD WORKS VEHICLES (contd.)

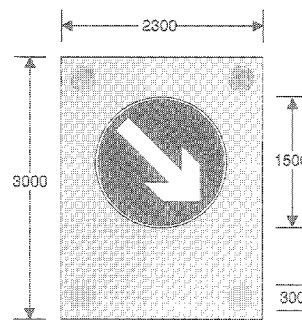
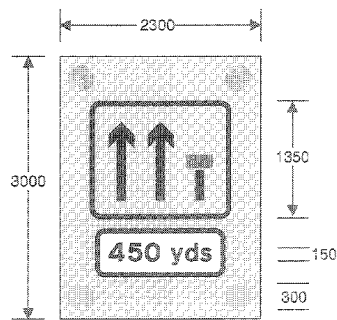
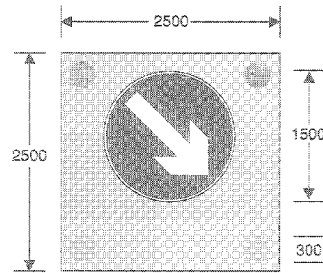
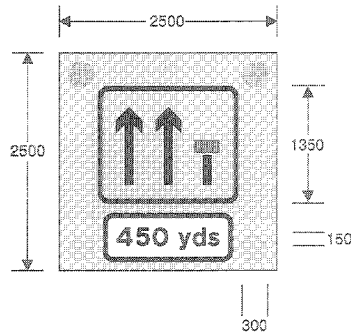

7402  
Lanes closed to traffic ahead by vehicles carrying out mobile road works (Alternative types)

Item	
1	Regulations: 14
2	Directions: 31
3	Diagrams: None
4	Permitted variants: Schedule 16, item 16 "450 yds" may be varied to an alternative distance to the nearest 50 yards or omitted
5	Illumination requirements: Schedule 17, item 5

7403  
Other traffic to keep to the right of vehicles carrying out mobile road works (Alternative types)

Item	
1	Regulations: 14, 28(4)
2	Directions: 31
3	Diagrams: None
4	Permitted variants: Arrow may point downwards to the left
5	Illumination requirements: Schedule 17, item 5

**Status:** This is the original version (as it was originally made). This item of legislation is currently only available in its original format.

SCHEDULE 12 PART V SIGNS MOUNTED ON ROAD WORKS VEHICLES (contd.)



7404  
Nature of work being done by vehicle working on the highway

Item	
1	Regulations: 14
2	Directions: 31
3	Diagrams: None
4	Permitted variants: "HIGHWAY" may be varied to "MOTORWAY"
5	Illumination requirements: Schedule 17, Item 9

## SCHEDULE 13

### Regulation 13(1)

*Status: This is the original version (as it was originally made). This item of legislation is currently only available in its original format.*

## PART I

### PROPORTIONS AND FORM OF LETTERS, NUMERALS AND OTHER CHARACTERS

(for use on a sign or parts of a sign with red, blue, brown, black or green background and on the signs shown in diagrams 2714 and 2715)

#### SCHEDULE 13 PART I

Regulation 13 (1)

#### PROPORTIONS AND FORM OF LETTERS, NUMERALS AND OTHER CHARACTERS

(for use on a sign or parts of a sign with a red, blue, brown, black or green background and on the signs shown in diagrams 2714 and 2715)

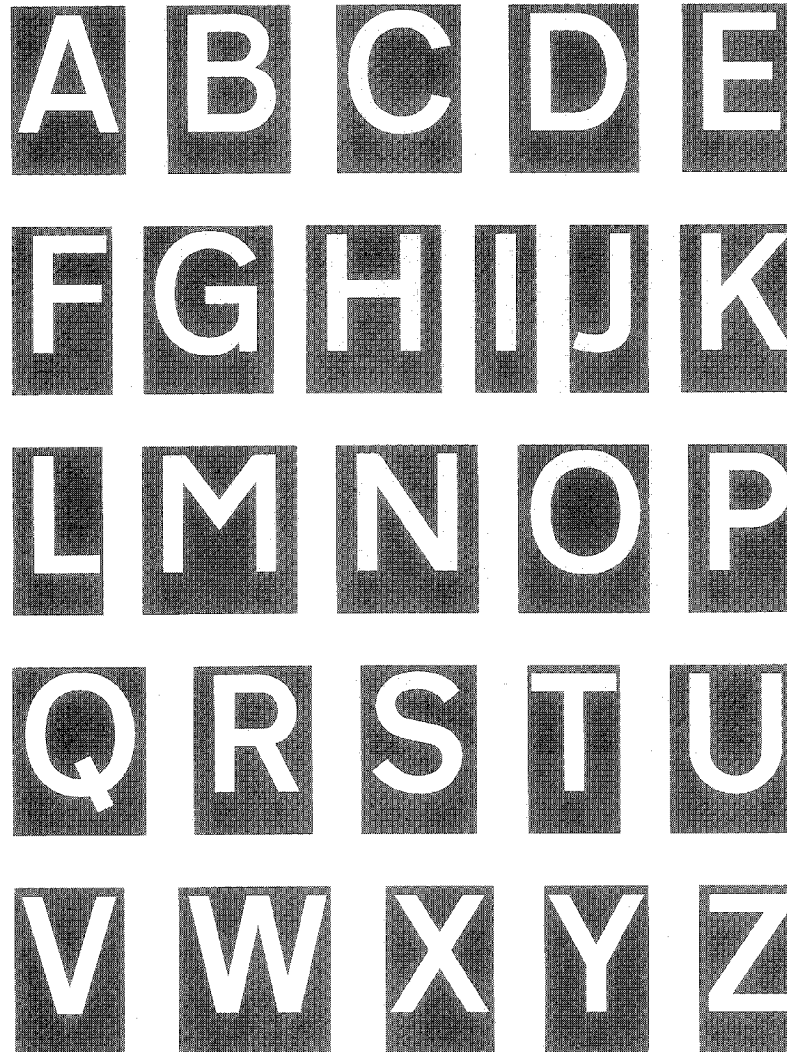



**Status:** This is the original version (as it was originally made). This item of legislation is currently only available in its original format.

SCHEDULE 13 PART I PROPORTIONS AND FORM OF LETTERS, NUMERALS  
AND OTHER CHARACTERS (contd.)

(for use on a sign or parts of a sign with a red, blue, brown, black or green  
background and on the signs shown in diagrams 2714 and 2715)

a b c d e

f g h i j k

l m n o p

q r s t u

v w x y z

**Status:** This is the original version (as it was originally made). This item of legislation is currently only available in its original format.

SCHEDULE 13 PART I PROPORTIONS AND FORM OF LETTERS, NUMERALS  
AND OTHER CHARACTERS (contd.)

(for use on a sign or parts of a sign with a red, blue, brown, black or green background and on the signs shown in diagrams 2714 and 2715)

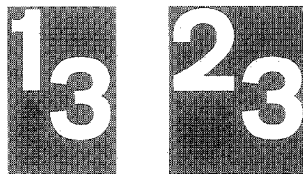
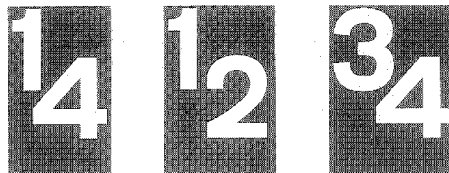
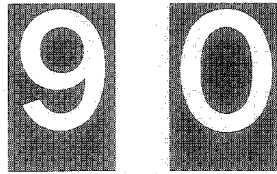
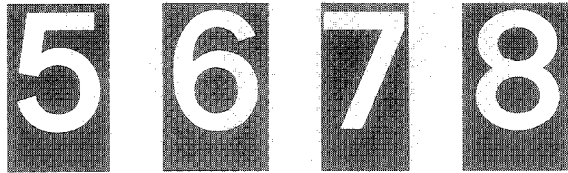
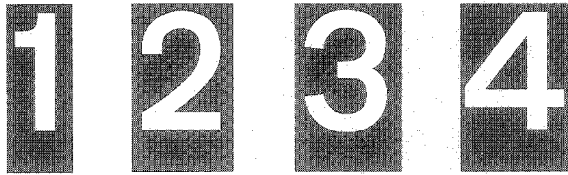

**Status:** This is the original version (as it was originally made). This item of legislation is currently only available in its original format.

SCHEDULE 13 PART I PROPORTIONS AND FORM OF LETTERS, NUMERALS  
AND OTHER CHARACTERS (contd.)

(for use on a sign or parts of a sign with a red, blue, brown, black or green background and on the signs shown in diagrams 2714 and 2715)

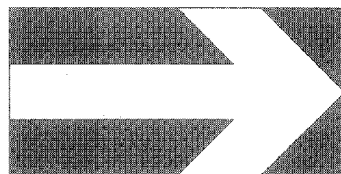
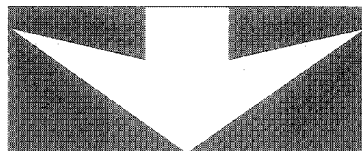
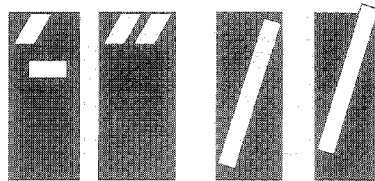
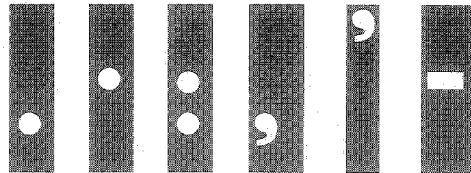
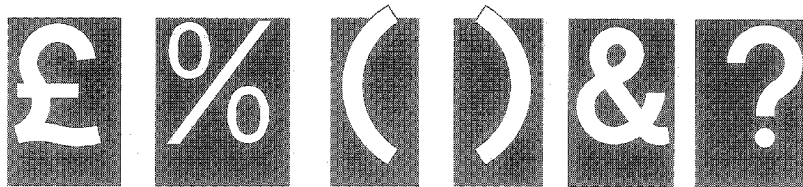

**Status:** This is the original version (as it was originally made). This item of legislation is currently only available in its original format.

## PART II

### PROPORTIONS AND FORM OF LETTERS, NUMERALS AND OTHER CHARACTERS

(for use on a sign or parts of a sign with a white, yellow or orange background and on the signs shown in diagrams 2714 and 2715)

#### SCHEDULE 13 PART II

Regulation 13 (1)

#### PROPORTIONS AND FORM OF LETTERS, NUMERALS AND OTHER CHARACTERS

(for use on a sign or parts of a sign with a white, yellow or orange background other than the signs shown in diagrams 2714 and 2715)

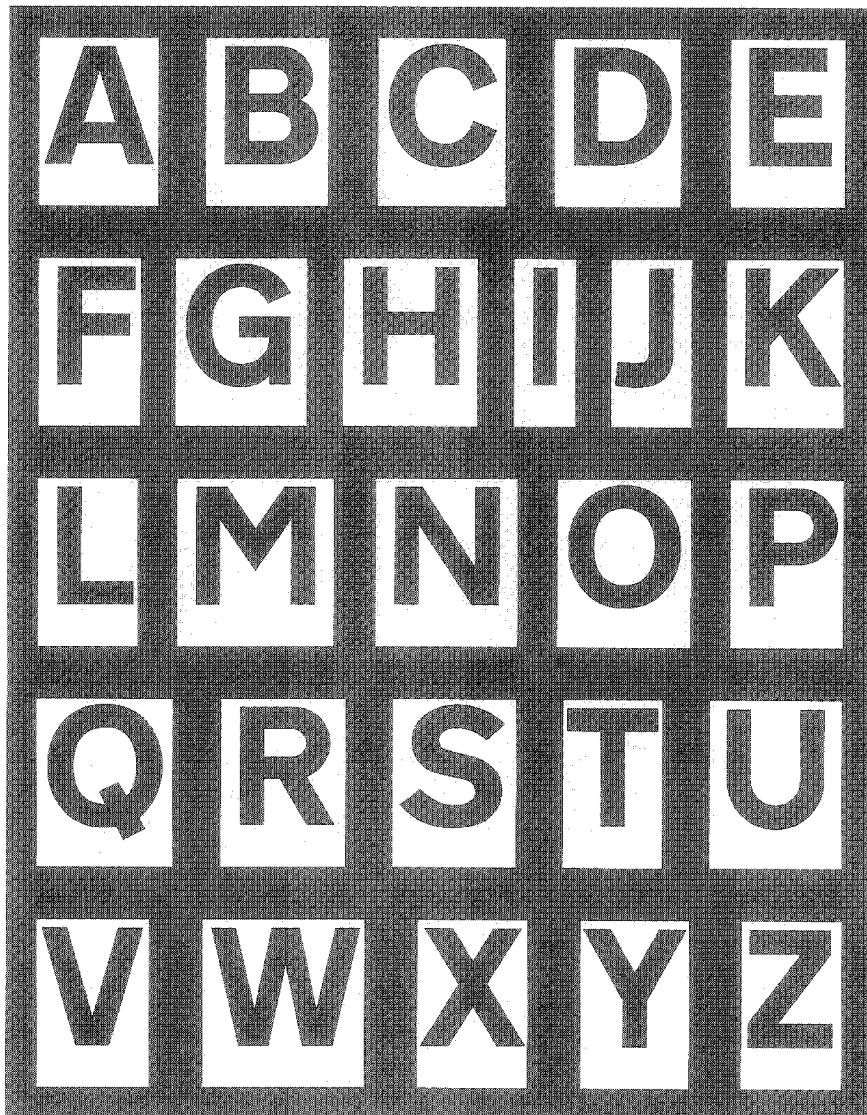

**Status:** This is the original version (as it was originally made). This item of legislation is currently only available in its original format.

SCHEDULE 13 PART II PROPORTIONS AND FORM OF LETTERS, NUMERALS  
AND OTHER CHARACTERS (contd.)

(for use on a sign or parts of a sign with a white, yellow or orange  
background other than the signs shown in diagrams 2714 and 2715)

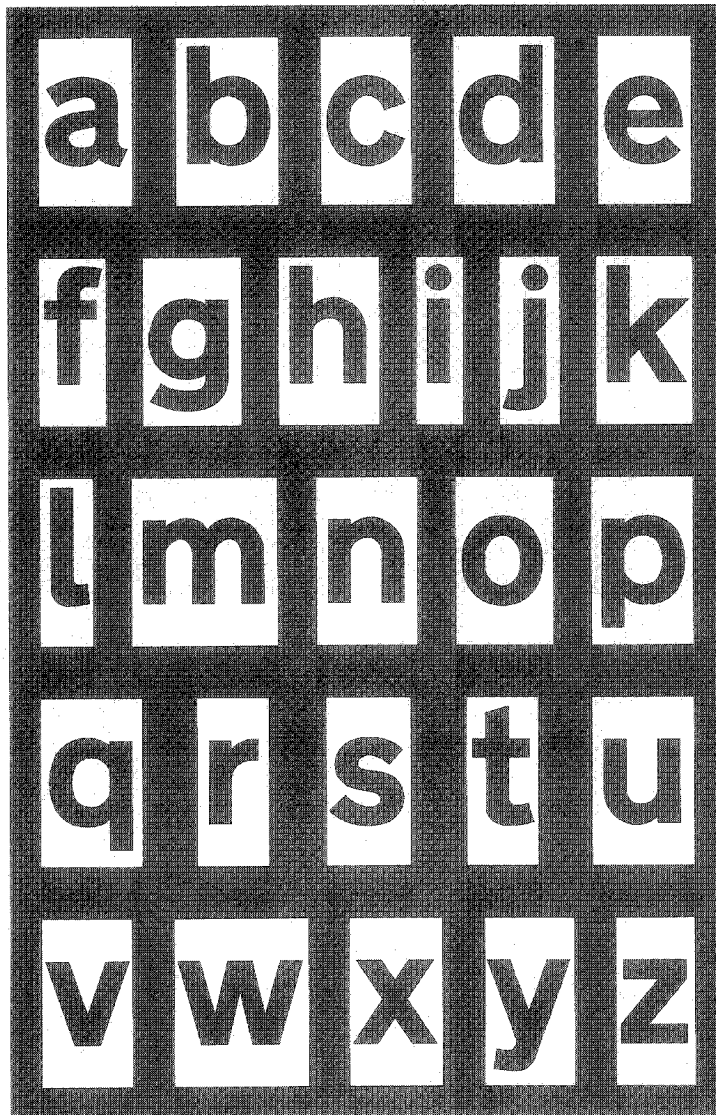

**Status:** This is the original version (as it was originally made). This item of legislation is currently only available in its original format.

SCHEDULE 13 PART II PROPORTIONS AND FORM OF LETTERS, NUMERALS  
AND OTHER CHARACTERS (contd.)

(for use on a sign or parts of a sign with a white, yellow or orange background other than the signs shown in diagrams 2714 and 2715)

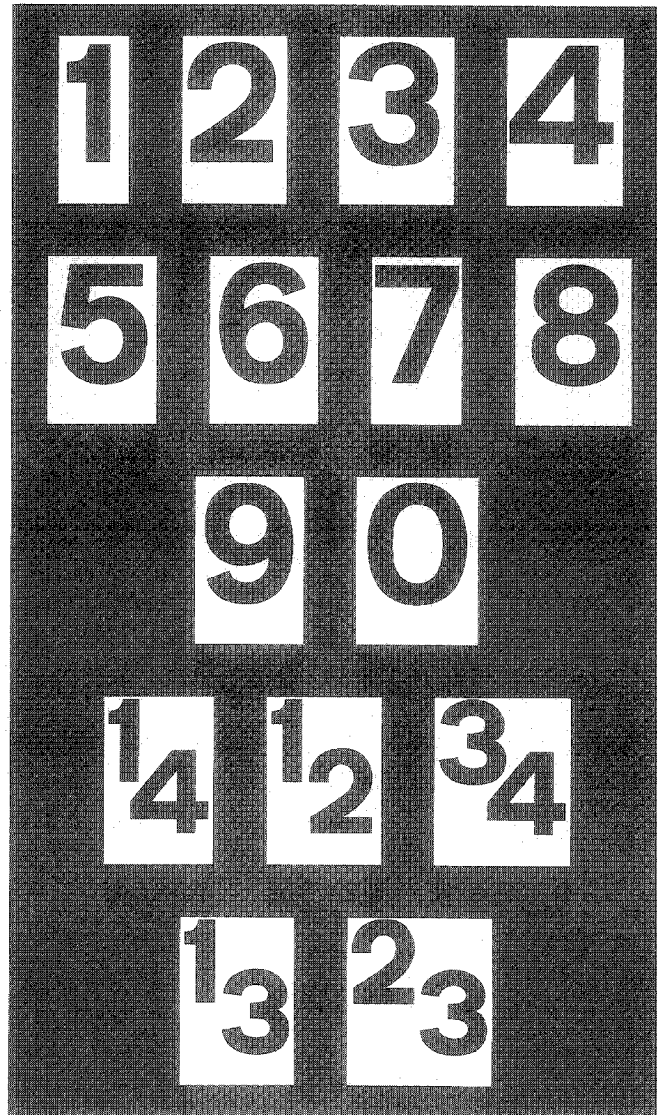

**Status:** This is the original version (as it was originally made). This item of legislation is currently only available in its original format.

SCHEDULE 13 PART II PROPORTIONS AND FORM OF LETTERS, NUMERALS  
AND OTHER CHARACTERS (contd.)

(for use on a sign or parts of a sign with a white, yellow or orange  
background other than the signs shown in diagrams 2714 and 2715)

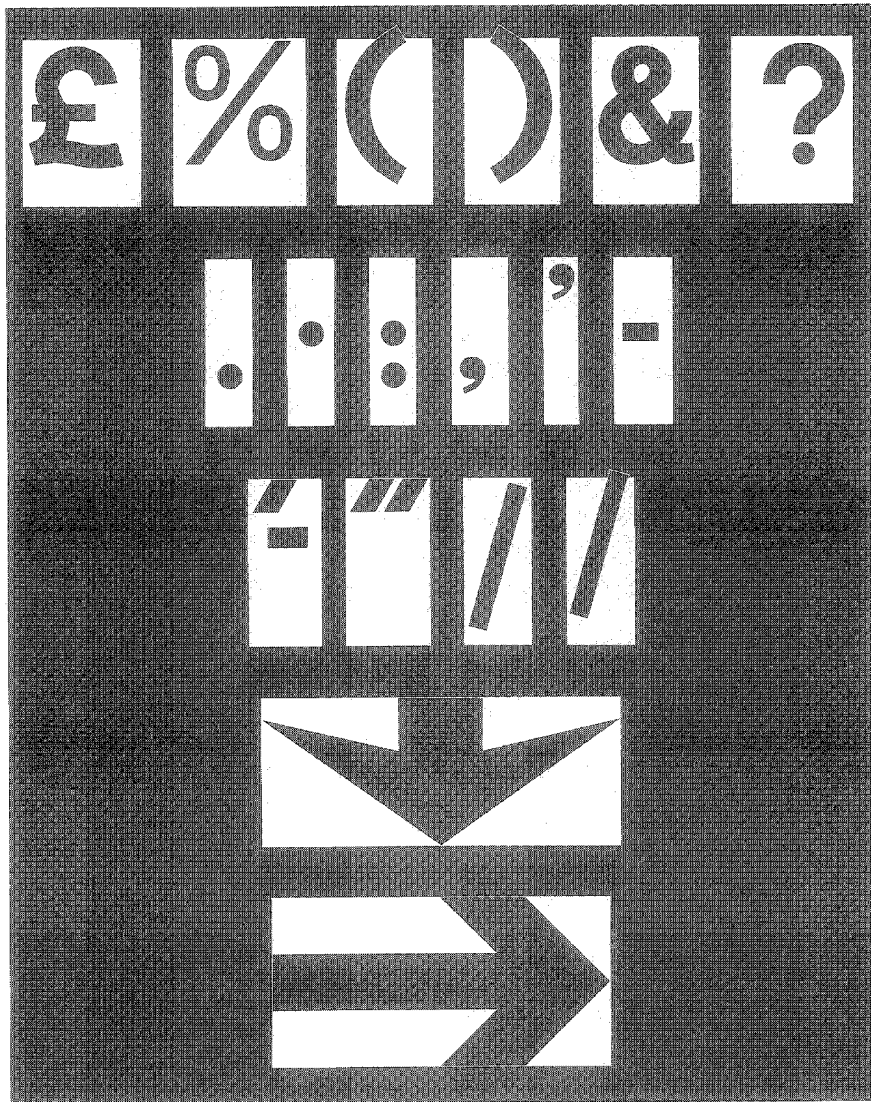

*Status: This is the original version (as it was originally made). This item of legislation is currently only available in its original format.*

### PART III

#### PROPORTIONS AND FORM OF LETTERS, NUMERALS AND OTHER CHARACTERS

(for route numbers on permanent motorway signs with blue backgrounds)

SCHEDULE 13 PART III

Regulation 13 (3)

PROPORTIONS AND FORM OF LETTERS, NUMERALS AND OTHER CHARACTERS  
(for route numbers on permanent motorway signs with blue backgrounds)

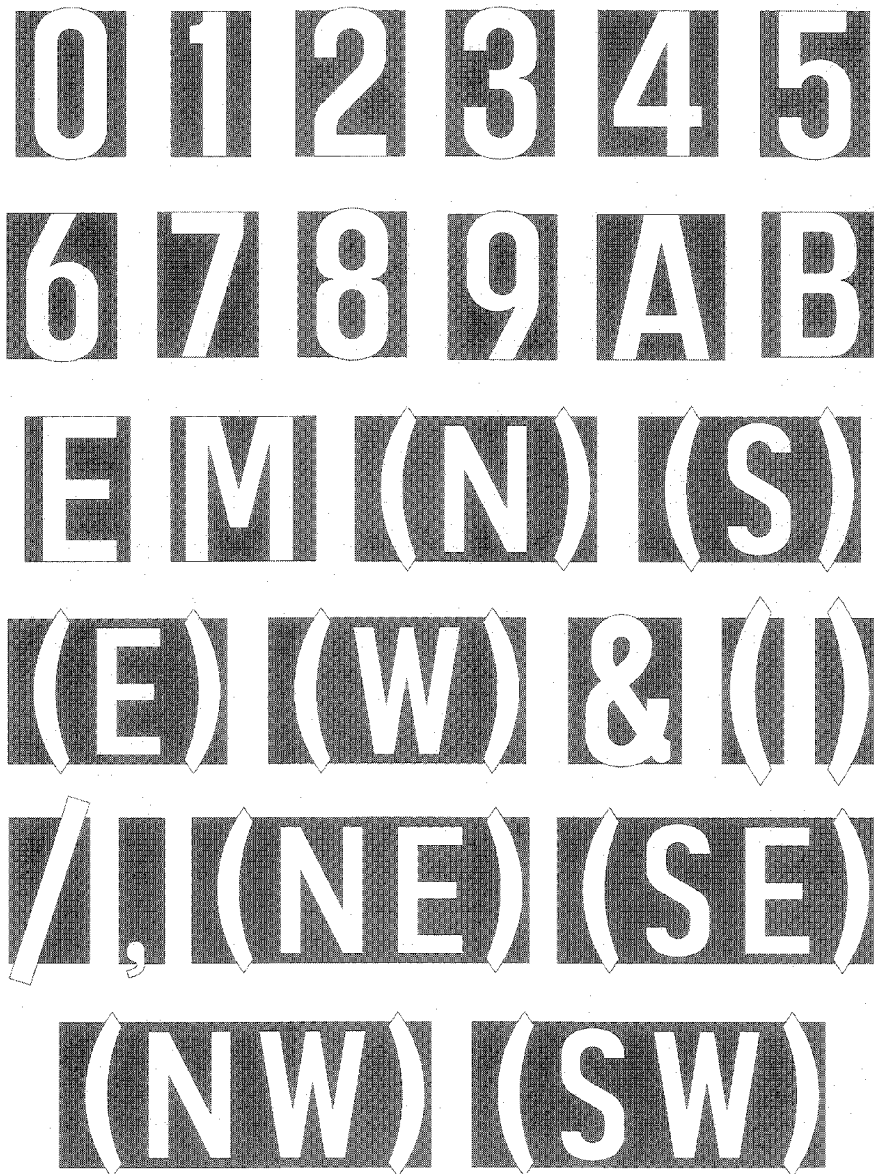



*Document Generated: 2023-08-10*

**Status:** *This is the original version (as it was originally made). This item of legislation is currently only available in its original format.*

Regulation 13(3)

*Status: This is the original version (as it was originally made). This item of legislation is currently only available in its original format.*

## PART IV

### PROPORTIONS AND FORM OF LETTERS, NUMERALS AND OTHER CHARACTERS

(for route numbers on temporary motorway signs with yellow backgrounds)

#### SCHEDULE 13 PART IV

Regulation 13 (3)

PROPORTIONS AND FORM OF LETTERS, NUMERALS AND OTHER CHARACTERS  
(for route numbers on temporary motorway signs with yellow backgrounds)



*Document Generated: 2023-08-10*

**Status:** *This is the original version (as it was originally made). This item of legislation is currently only available in its original format.*

Regulation 13(5)

**Status:** This is the original version (as it was originally made). This item of legislation is currently only available in its original format.

## PART V

### PROPORTIONS AND FORM OF LETTERS, NUMERALS AND OTHER CHARACTERS FOR USE ON VARIABLE MESSAGE SIGNS

(where the characters shown in Parts I, II, III and IV cannot be used because of the method of construction or operation of the sign)

#### SCHEDULE 13 PART V

Regulation 13(5)

#### PROPORTIONS AND FORM OF LETTERS, NUMERALS AND OTHER CHARACTERS FOR USE ON VARIABLE MESSAGE SIGNS

(where the characters shown in Parts I, II, III and IV cannot be used because of the method of construction or operation of the sign)

A B C D E E F

G H I J K L L

M N O P Q R S

T U V W X Y Z

0 1 2 3 4 4

5 6 7 8 9

& £ . , ' "

*Document Generated: 2023-08-10*

**Status:** *This is the original version (as it was originally made). This item of legislation is currently only available in its original format.*

Regulation 13(6)

**Status:** This is the original version (as it was originally made). This item of legislation is currently only available in its original format.

## PART VI

### PROPORTIONS AND FORM OF LETTERS, NUMERALS AND OTHER CHARACTERS FOR USE IN THE ROAD MARKINGS SHOWN IN SCHEDULE 6

(a) with a height of 1.6 metres

SCHEDULE 13 PART VI Regulation 13(6)  
PROPORTIONS AND FORM OF LETTERS, NUMERALS AND OTHER CHARACTERS FOR USE IN THE ROAD MARKINGS SHOWN IN SCHEDULE 6  
(a) with a height of 1.8 metres

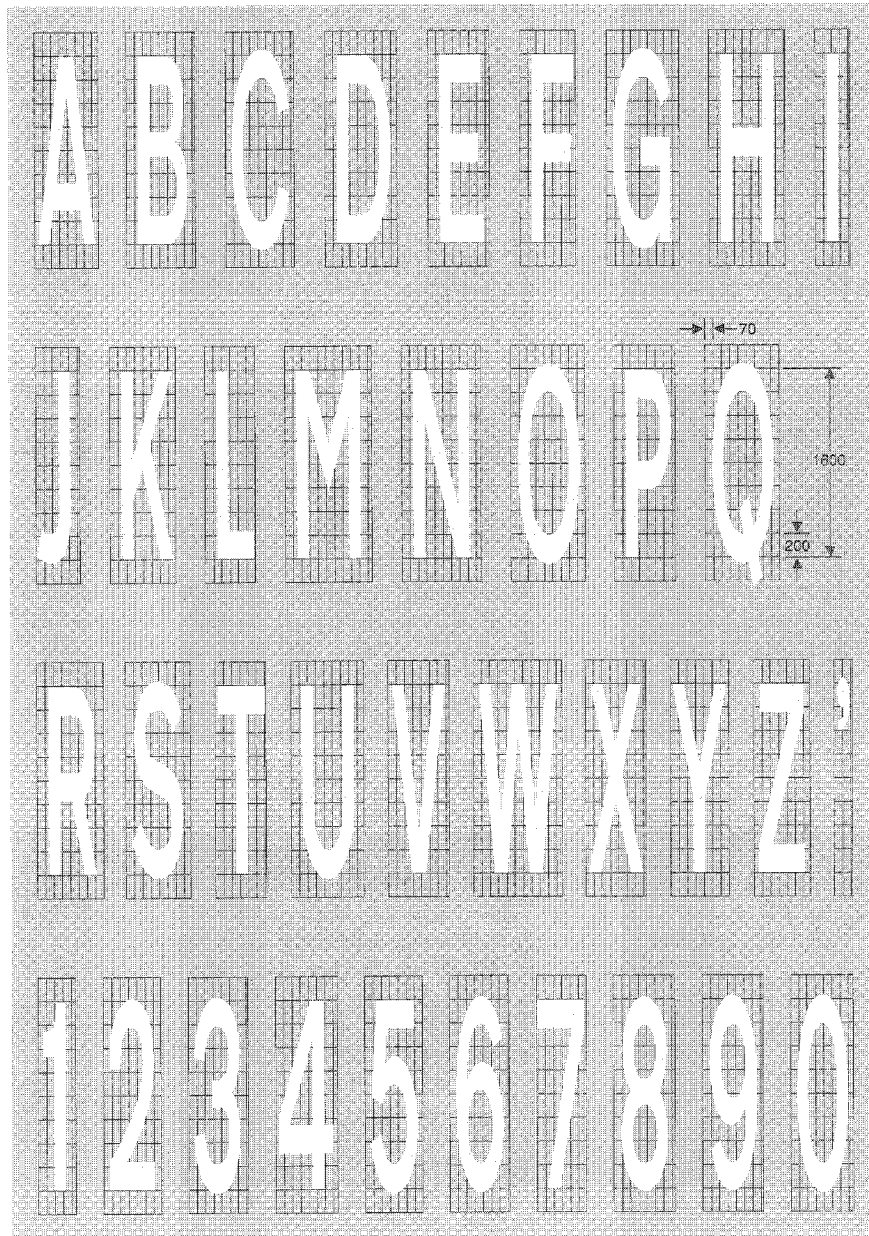

**Status:** This is the original version (as it was originally made). This item of legislation is currently only available in its original format.

(b) with a height of 2.8 metres

SCHEDULE 13 PART VI Regulation 13(8)  
PROPORTIONS AND FORM OF LETTERS, NUMERALS AND OTHER  
CHARACTERS FOR USE IN THE ROAD MARKINGS SHOWN IN SCHEDULE 6  
(b) with a height of 2.8 metres

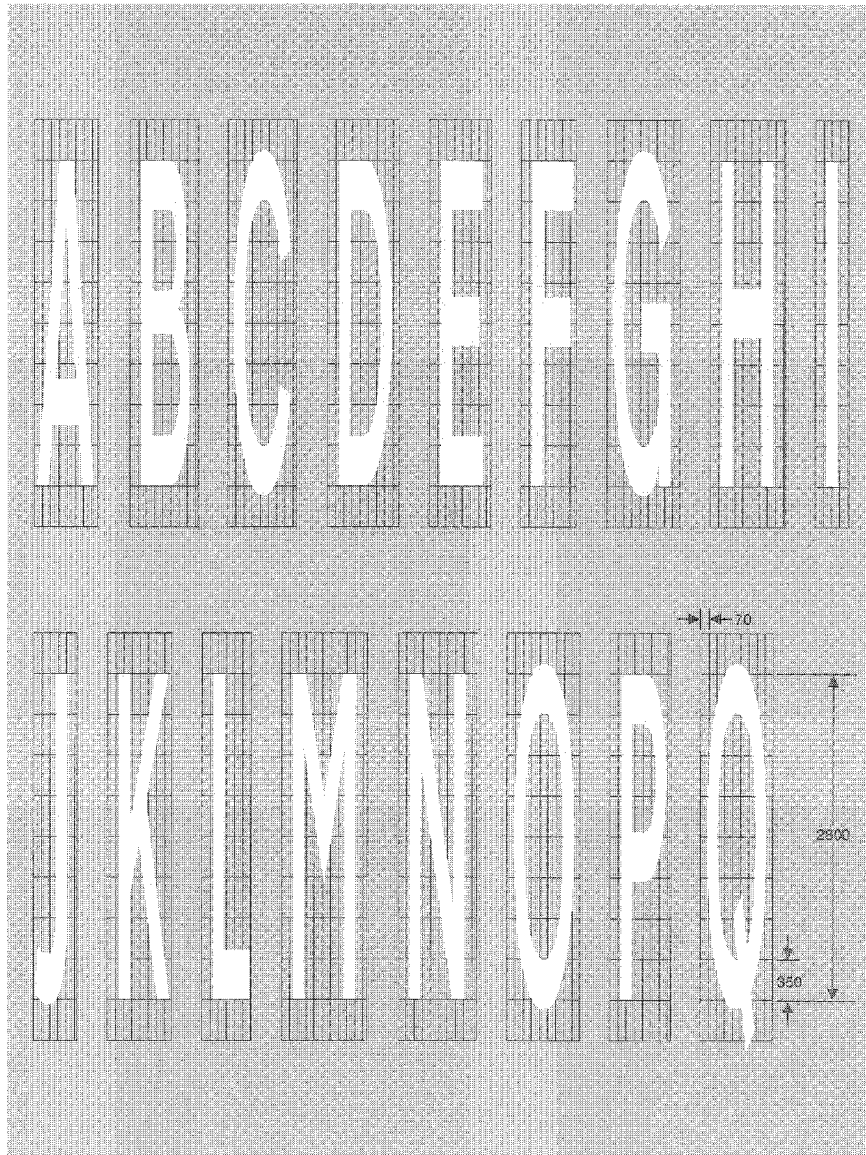

**Status:** This is the original version (as it was originally made). This item of legislation is currently only available in its original format.

SCHEDULE 13 PART VI PROPORTIONS AND FORM OF LETTERS, NUMERALS AND OTHER CHARACTERS FOR USE IN THE ROAD MARKINGS SHOWN IN SCHEDULE 6 (contd.)  
(b) with a height of 2.8 metres

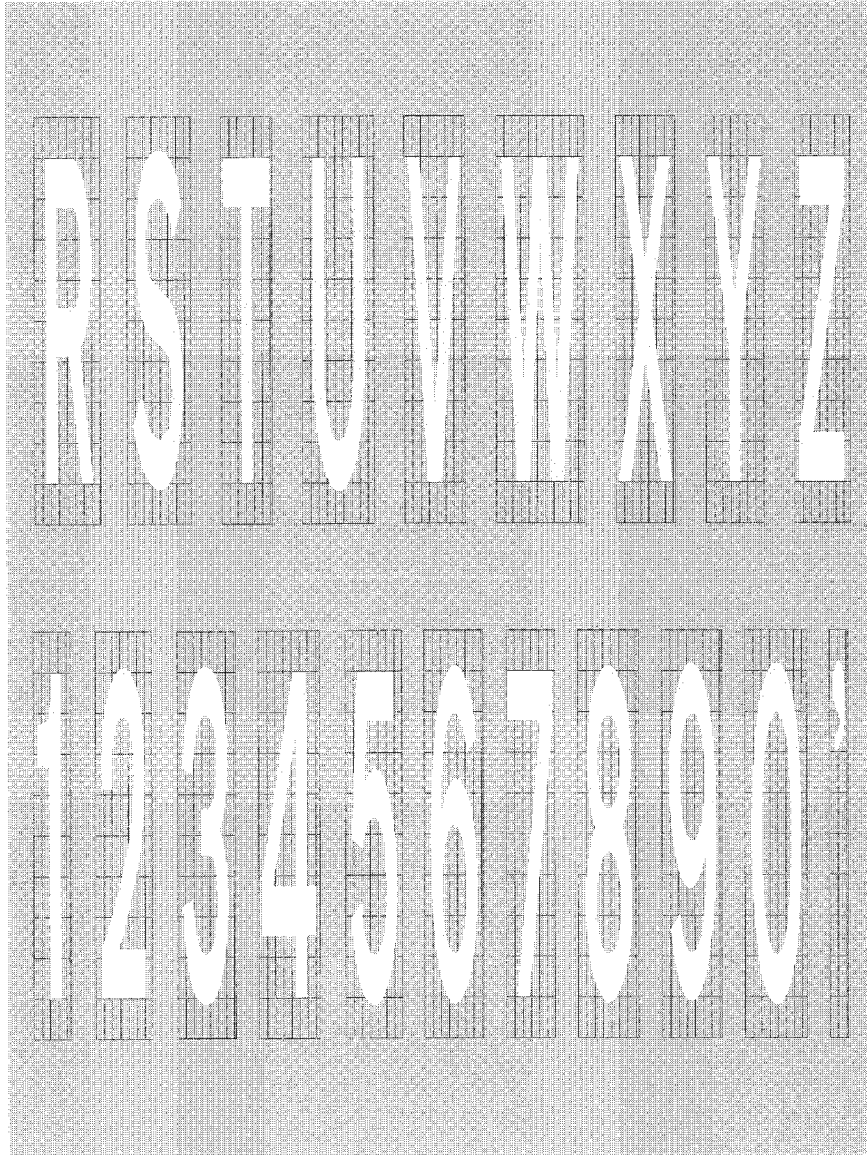



**Status:** This is the original version (as it was originally made). This item of legislation is currently only available in its original format.

*(c) for use in the road markings shown in diagrams  
1027.1, 1028.2, 1028.3, 1028.4, 1029 and 1033*

SCHEDULE 13 PART VI Regulation 13(6)  
PROPORTIONS AND FORM OF LETTERS, NUMERALS AND OTHER CHARACTERS  
FOR USE IN THE ROAD MARKINGS SHOWN IN SCHEDULE 6  
(c) for use in the road markings shown in diagrams 1027.1, 1028.2, 1028.3, 1028.4, 1029 and 1033

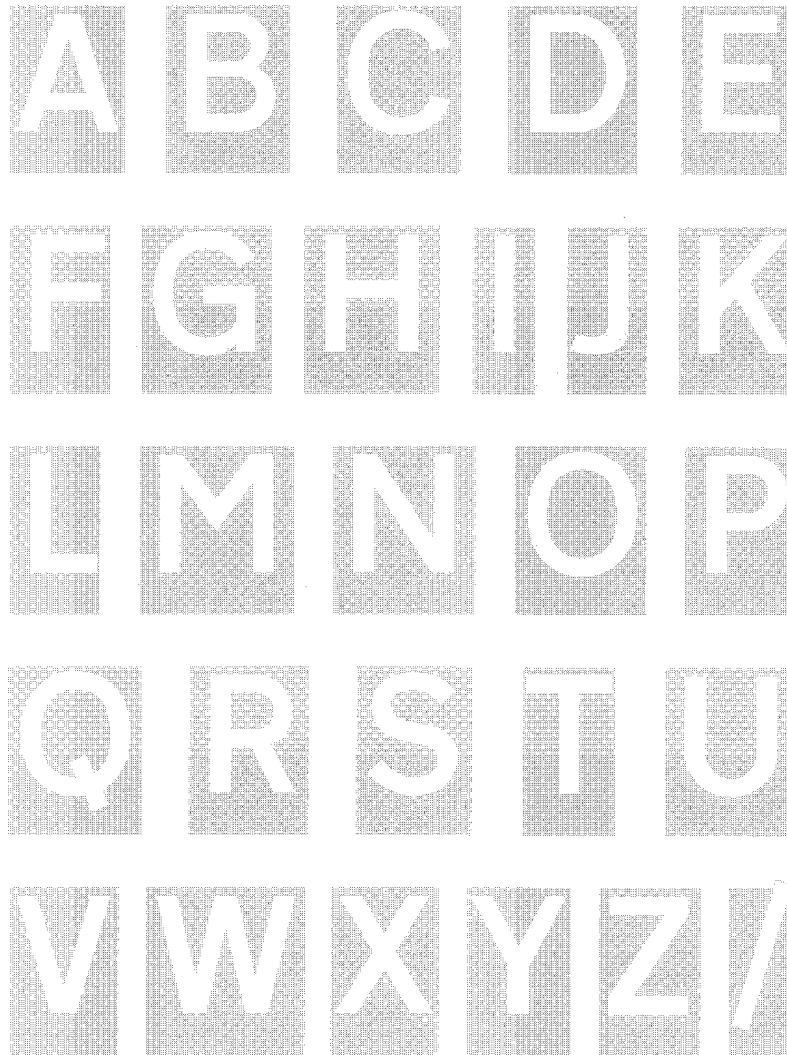

**Status:** This is the original version (as it was originally made). This item of legislation is currently only available in its original format.

## PART VII

### PROPORTIONS AND FORM OF LETTERS, NUMERALS AND OTHER CHARACTERS

(Symbols for use on directional signs to indicate diversion routes)

#### SCHEDULE 13 PART VII

Regulation 13

PROPORTIONS AND FORM OF LETTERS, NUMERALS AND OTHER CHARACTERS  
(Symbols for use on directional signs to indicate diversion routes)

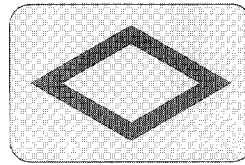
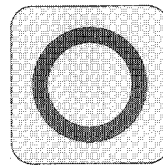
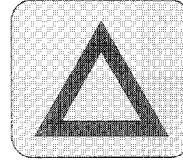
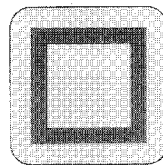
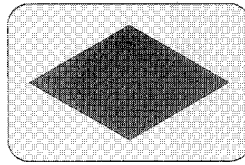
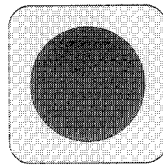
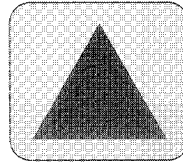
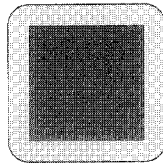

## SCHEDULE 14

Regulation 13(8)

**Status:** This is the original version (as it was originally made). This item of legislation is currently only available in its original format.

## PART I

### PROPORTIONS AND FORM OF SYMBOLS INDICATING THE TYPE OF TOURIST ATTRACTION IN ENGLAND, SCOTLAND AND WALES

#### SCHEDULE 14 PART I

Regulation 13(8)

#### PROPORTIONS AND FORM OF SYMBOLS INDICATING THE TYPE OF TOURIST ATTRACTION IN ENGLAND, SCOTLAND AND WALES

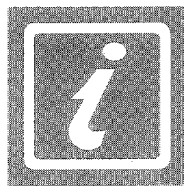

T1  
Tourist Information Point

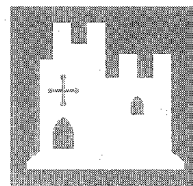

T2  
Castle of historic  
or architectural interest

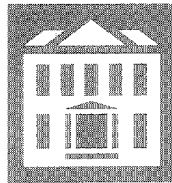

T3  
House of historic  
or architectural interest

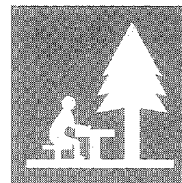

T4  
Picnic area



T5  
Youth Hostel  
(See caption under diagram 2303 for usage)

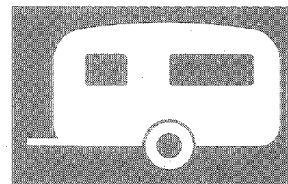

T6  
Caravan site  
(See caption under diagram 2301 for usage)

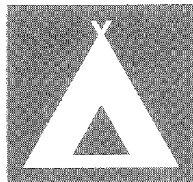

T7  
Camping site  
(See caption under diagram 2301 for usage)

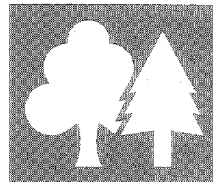

T8  
Woodland recreation area



T9  
Viewpoint

## Regulation 13(8)

**Status:** This is the original version (as it was originally made). This item of legislation is currently only available in its original format.

## PART II

### PROPORTIONS AND FORM OF SYMBOLS INDICATING THE TYPE OF TOURIST ATTRACTION IN ENGLAND AND WALES

#### SCHEDULE 14 PART II

Regulation 13(8)

#### PROPORTIONS AND FORM OF SYMBOLS INDICATING THE TYPE OF TOURIST ATTRACTION IN ENGLAND AND WALES

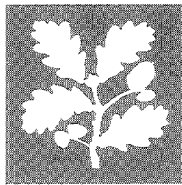

T101  
National Trust property

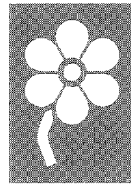

T102  
Flower garden

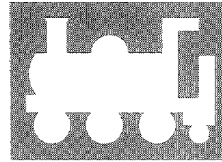

T103  
Preserved or tourist railway  
or railway museum

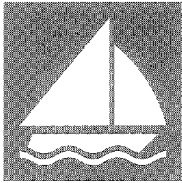

T104  
Water sport activities

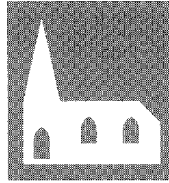

T105  
Church of historic or  
architectural interest

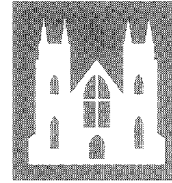

T106  
Cathedral of historic or  
architectural interest

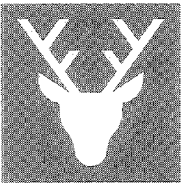

T107  
Wildlife park

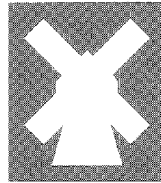

T108  
Windmill of historic or  
architectural interest

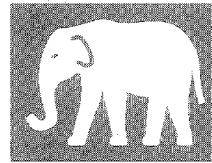

T109  
Zoo

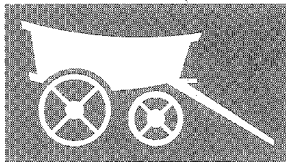

T110  
Agricultural museum

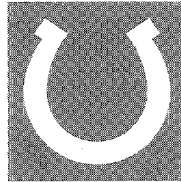

T111  
Equestrian centre

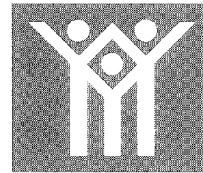

T112  
Country park

**Status:** This is the original version (as it was originally made). This item of legislation is currently only available in its original format.

SCHEDULE 14 PART II PROPORTIONS AND FORM OF SYMBOLS INDICATING THE TYPE OF TOURIST ATTRACTION IN ENGLAND AND WALES (contd.)



T113  
Bird garden

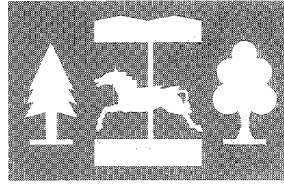

T114  
Pleasure or theme park  
(Both trees may be of the same type,  
and either or both trees may be omitted)

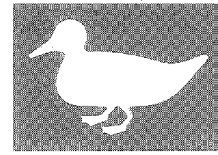

T115  
Nature reserve

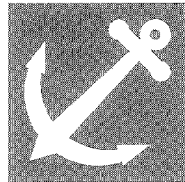

T116  
Historic dockyard or attraction  
of maritime interest

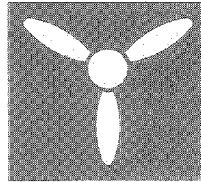

T117  
Air museum

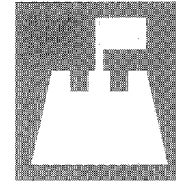

T118  
Beach

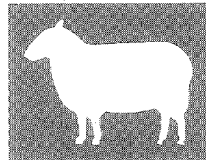

T119  
Farm park



T120  
Pottery or craft centre

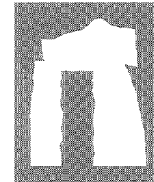

T121  
Prehistoric site or  
monument

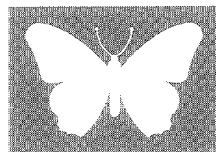

T122  
Butterfly farm

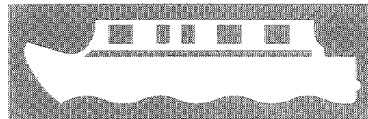

T123  
Canal-side attraction

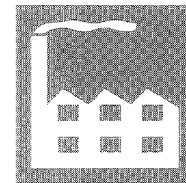

T124  
Industrial heritage  
museum or attraction

**Status:** This is the original version (as it was originally made). This item of legislation is currently only available in its original format.

SCHEDULE 14 PART II PROPORTIONS AND FORM OF SYMBOLS INDICATING THE TYPE OF TOURIST ATTRACTION IN ENGLAND AND WALES (contd.)

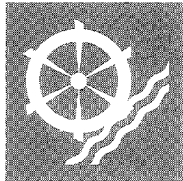

T125  
Watermill of historic or architectural interest

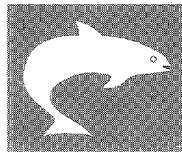

T126  
Aquarium or oceanarium

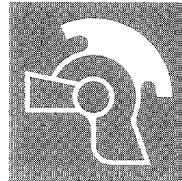

T127  
Site with Roman remains

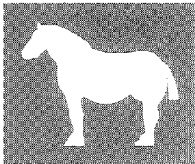

T128  
Shire horse centre

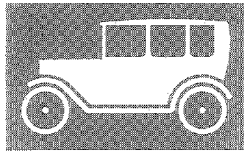

T129  
Motor museum

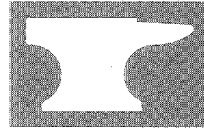

T130  
Craft centre or forge

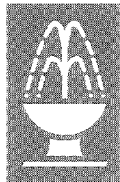

T131  
Spa, spring or fountain of particular interest

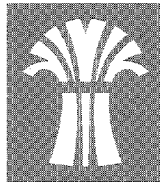

T132  
Farm trail

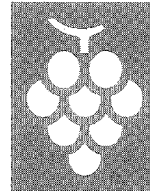

T133  
Vineyard



**Status:** This is the original version (as it was originally made). This item of legislation is currently only available in its original format.

### PART III

#### PROPORTIONS AND FORM OF SYMBOLS INDICATING THE TYPE OF TOURIST ATTRACTION IN ENGLAND ONLY

##### SCHEDULE 14 PART III

Regulation 13(8)

##### PROPORTIONS AND FORM OF SYMBOLS INDICATING THE TYPE OF TOURIST ATTRACTION IN ENGLAND ONLY

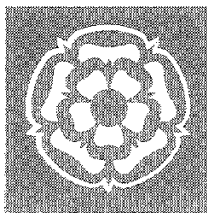

T201  
Tourist attraction recognised by a regional tourist board of the English Tourist Board

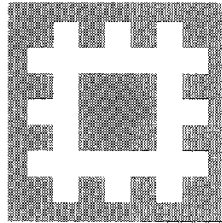

T202  
Property in the care of English Heritage

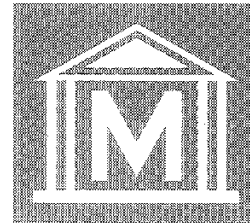

T203  
Museum or art gallery

Regulation 13(8)

### PART IV

#### PROPORTIONS AND FORM OF SYMBOLS INDICATING THE TYPE OF TOURIST ATTRACTION IN SCOTLAND ONLY

##### SCHEDULE 14 PART IV

Regulation 13(8)

##### PROPORTIONS AND FORM OF SYMBOLS INDICATING THE TYPE OF TOURIST ATTRACTION IN SCOTLAND ONLY

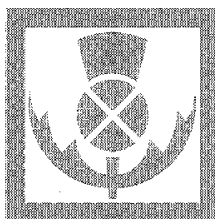

T301  
Tourist attraction recognised by the Scottish Tourist Board  
(The thistle symbol may be shown in white on a brown sign indicating a National Tourist Route)

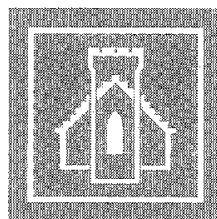

T302  
Property in the care of the Historic Buildings and Monuments Directorate

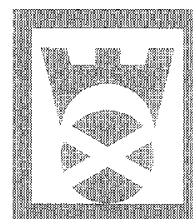

T303  
National Trust for Scotland property  
(The words "National Trust for Scotland" may be added and the symbol varied to white on a brown background)

Regulation 13(8)

*Status: This is the original version (as it was originally made). This item of legislation is currently only available in its original format.*

## PART V

### PROPORTIONS AND FORM OF SYMBOLS INDICATING THE TYPE OF TOURIST ATTRACTION IN WALES ONLY

#### SCHEDULE 14 PART V

Regulation 13(8)

#### PROPORTIONS AND FORM OF SYMBOLS INDICATING THE TYPE OF TOURIST ATTRACTION IN WALES ONLY

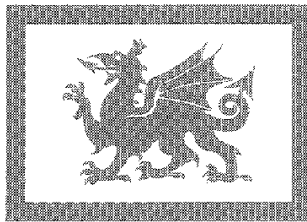

T401  
Tourist attraction recognised by  
the Wales Tourist Board

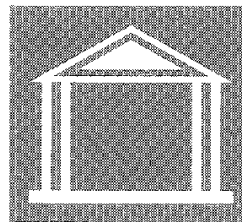

T402  
Museum or art gallery

#### SCHEDULE 15

Regulation 46

#### LEGENDS FOR USE ON VARIABLE MESSAGE SIGNS

### PART I

#### SIGNS AUTOMATICALLY ACTIVATED BY VEHICULAR TRAFFIC

1. One of the following legends may be displayed on a sign which is activated automatically by a particular type of vehicle approaching the equipment which controls the sign

- (a) "OVERHEIGHT VEHICLE DIVERT" with
  - (i) an arrow;
  - (ii) "USE" and a route number; or
  - (iii) "FOLLOW" and a symbol shown in Part VII of Schedule 13;
- (b) "OVERHEIGHT VEHICLE TURN BACK";
- (c) "HIGH VEHICLE USE MIDDLE OF ROAD"; or
- (d) "ONCOMING VEHICLE IN MIDDLE OF ROAD".

**Status:** This is the original version (as it was originally made). This item of legislation is currently only available in its original format.

## PART II

### LEGENDS GIVING WARNINGS OF ADVERSE WEATHER OR OTHER TEMPORARY HAZARDS

2. A legend shown in an item in column (2) of the Table may be used only in conjunction with one of the legends shown in any item in column (3). In addition one of the legends shown in any item in column (4) may also be displayed. The information indicated in square brackets may be omitted. The number of a motorway junction should be shown on the sign in the format of the letter “J” followed by the number of the junction.

**Table**

(1) <i>Item</i>	(2) <i>Type of hazard</i>	(3) <i>Location of hazard (for use with any item in column (2))</i>	(4) <i>Additional information (optional-for use with any appropriate combination of items in columns (2) and (3))</i>
1.	“HIGH WINDS”	A route number, including abbreviated compass point directions where appropriate	“[LONG] DELAYS”
2.	“SNOW”	“AT” and a place name, the name of a bridge or tunnel, or a junction name or number	A number and “HR DELAYS”
3.	“FOG”	“AFTER” and a place name, the name of a bridge or tunnel, or a junction name or number	[“CARS”, “HGV'S”, “CARAVANS” or “M'CYCLES”] “USE” and a route number or numbers, including abbreviated compass point directions where appropriate
4.	“FLOODS”	A number and “MILES AHEAD”	[“CARS”, “HGV'S”, “CARAVANS” or “M'CYCLES”] “FOLLOW” and a symbol shown in Part VII of Schedule 13 or a place name
5.	“QUEUE”	“AHEAD”	[“CARS”, “HGV'S”, “CARAVANS” or “M'CYCLES”] and “LEAVE AT NEXT JCT”, “LEAVE AT”

**Status:** This is the original version (as it was originally made). This item of legislation is currently only available in its original format.

(1) <i>Item</i>	(2) <i>Type of hazard</i>	(3) <i>Location of hazard (for use with any item in column (2))</i>	(4) <i>Additional information (optional-for use with any appropriate combination of items in columns (2) and (3))</i>
			and a junction name or number
6.	“ACCIDENT”		“SLOW DOWN”
7.	“SETTING OUT ROAD WORKS”		

### PART III

#### INFORMATION ON DIVERSION ROUTES

3. One of the legends shown in any item in column (3) of the Table may be used in conjunction with a legend shown in any item in column (2). The information indicated in square brackets may be omitted. The number of a motorway junction should be shown on the sign in the format of the letter “J” followed by the number of the junction.

**Table**

(1) <i>Item</i>	(2) <i>Basic Message</i>	(3) <i>Alternative route information (optional-for use with any item in column (2))</i>
1.	A route number, including abbreviated compass point direction where appropriate, or junction name including abbreviated compass point directions where appropriate	“[ALTERNATIVE ROUTE] USE” and a route number or numbers, or number and the word “CLOSED”.
2.	“ROAD CLOSED”	“[ALTERNATIVE ROUTE] FOLLOW” and a symbol shown in Part VII of Schedule 13 or a place name
3.	[Name] “BRIDGE CLOSED”	“FOR” and a place name “USE” and a route number or numbers, including abbreviated compass point directions where appropriate
4.	[Name] “TUNNEL CLOSED”	“FOR” and a place name “FOLLOW” and a symbol shown in Part VII of

**Status:** This is the original version (as it was originally made). This item of legislation is currently only available in its original format.

(1) <i>Item</i>	(2) <i>Basic Message</i>	(3) <i>Alternative route information (optional-for use with any item in column (2))</i>
		Schedule 13 or another place name
5.	“ROAD WORKS”	“LEAVE AT NEXT JCT”, “LEAVE AT” and a junction name or number

## PART IV

### OTHER LEGENDS

4. The following legends may also be displayed on a variable message sign
- “SIGNAL UNDER TEST”
  - “SIGN UNDER TEST”

In either case the message may be used with a pattern displayed which has no particular meaning but which is designed to test the functioning of the sign or signal.

### SCHEDULE 16

Regulation 17

#### PERMITTED VARIANTS

(1) <i>Item</i>	(2) <i>Diagram numbers</i>	(3) <i>Permitted variant</i>
1.	513.2, 523.1, 524.1, 530, 531.1, 532.2, 532.3, 629, 629.1, 629.2, 629.2A, 669.1 (other than in respect of distance), 670, 672, 673, 675, 780, 780.1 (in respect of height), 780.2, 6001, 7275, 7283, 7284, 7290 (in respect of speed limit)	Numerals may be varied but (with the exception of 0.5 tonne and one decimal place of a metre indicating a height, width or length) no fractions or decimal places shall be used.
2.	629, 629.1, 780, 780.1 (in respect of height), 780.2	Metric units to one decimal place of a metre may be substituted for imperial units.
3.	2001, 2002, 2003, 2004, 2005, 2006, 2007, 2008, 2009, 2022, 2023, 2024, 2025, 2026, 2027, 2028, 2029, 2033, 2101, 2102, 2104, 2105, 2108, 2109, 2110, 2111, 2112, 2113, 2113.1, 2118, 2119, 2120, 2121, 2122, 2127, 2131, 2132, 2133, 2134, 2205, 2213, 2214, 2216, 2322,	An indication of distance to the destination may be shown in accordance with item 4, 5 or 6.

**Status:** This is the original version (as it was originally made). This item of legislation is currently only available in its original format.

(1) <i>Item</i>	(2) <i>Diagram numbers</i>	(3) <i>Permitted variant</i>
	2323, 2504, 2505, 2506, 2507, 2603, 2605, 2606, 2607, 2608, 2609, 2610, 2610.2, 2701, 2705, 2706, 2707, 2801, 2802, 2803, 2804, 2807, 2925	
4.	2911, 2912, 2917, 2918	Numerals indicating distance may be varied with distances being expressed in miles to the nearest mile.
5.	527, 583.1, 2001, 2002, 2003, 2004, 2005, 2006, 2007, 2008, 2009, 2022, 2023, 2024, 2025, 2026, 2027, 2028, 2029, 2030, 2030.1, 2033, 2101, 2102, 2103, 2104, 2105, 2106, 2107, 2108, 2109, 2110, 2111, 2112, 2113, 2113.1, 2118, 2119, 2120, 2121, 2122, 2125, 2126, 2127, 2128, 2131, 2132, 2206, 2207, 2209, 2213, 2214, 2309, 2601, 2602, 2705, 2706, 2707, 2803, 2804, 2807, 2925, 2926, 7273	Numerals indicating distance may be varied with distances being expressed in miles except that the fractions $\frac{3}{4}$ , $\frac{1}{2}$ and $\frac{1}{4}$ may be used for distances of less than 3 miles.
6.	502, 503, 547.3, 548.1, 556.2, 557.2, 557.3, 557.4, 570, 572, 573, 669 and 669.1 (in respect of distance), 780.1 (in respect of distance), 818.1, 876, 2010, 2123, 2133, 2134, 2201, 2202, 2203, 2204, 2205, 2216, 2301, 2302, 2303, 2304, 2305, 2306, 2307, 2316, 2317, 2318, 2319, 2320, 2321, 2322, 2323, 2501, 2502, 2503, 2504, 2505, 2506, 2507, 2508, 2603, 2604, 2605, 2606, 2607, 2608, 2609, 2610, 2610.1, 2610.2, 2701, 2713.1, 2801, 2802, 2916, 5014, 7012, 7015, 7208, 7209, 7306, 7307	Numerals indicating distance may be varied with— (a) distances of over 3 miles being expressed in miles to the nearest mile; (b) distances of $\frac{1}{2}$ mile or more but less than 3 miles being expressed to the nearest $\frac{1}{4}$ mile with the fractions $\frac{3}{4}$ , $\frac{1}{2}$ and $\frac{1}{4}$ being used; and (c) distances of less than $\frac{1}{2}$ mile being expressed in yards to the nearest 10 yards; “yards” or “YARDS” and the abbreviation “yds” may be used interchangeably.
7.	832.6, 832.7, 2011, 2012, 2013, 2017, 2020, 2021, 2101.1, 2115, 2116, 2117, 2310, 2313, 2903, 2904, 2905, 2908, 2909	Numerals indicating distance to a junction ahead may be varied by the substitution of the figure 1 or the fractions $\frac{1}{3}$ or $\frac{2}{3}$ as appropriate for the location of the sign.

**Status:** This is the original version (as it was originally made). This item of legislation is currently only available in its original format.

(1) <i>Item</i>	(2) <i>Diagram numbers</i>	(3) <i>Permitted variant</i>
8.	2919	“ $\frac{1}{2}m$ ” may be varied to “ $1\frac{1}{2}m$ ” or “ $1/3m$ ”.
9.	556.2, 573, 2020, 2021, 2103, 2106, 2107, 2112, 2116, 2117, 2125, 2126, 2202, 2203, 2204, 2206, 2207, 2302, 2304, 2306, 2309, 2316, 2317, 2318, 2319, 2320, 2321, 2501, 2508, 2601, 2602, 2604, 2610.1, 2713.1, 2905, 2908, 2909	The indication of distance may be omitted from the sign.
10.	669, 669.1, 2201, 2301, 2303, 2305, 2307, 2319, 2501, 2502, 2503	The indication of distance may be replaced by an arrow pointing horizontally to the left or to the right as appropriate.
11.	637, 637.1, 637.3, 638, 639.1A, 650.1, 650.2, 651, 660, 660.3, 660.4, 660.5, 661, 661.1, 662, 669, 669.1, 2201, 2205, 2301, 2303, 2305, 2319, 2503, 2713.1, 7271	An arrow may be added to the sign, pointing to the left or to the right as appropriate.
12.	780.1, 2003, 2005, 2006, 2019, 2028, 2029, 2103, 2106, 2107, 2111, 2114, 2127, 2131, 2133, 2135, 2202, 2206, 2210, 2213, 2215, 2216, 2308, 2311, 2312.1, 2314, 2315.1, 2505, 2506, 2509, 2601, 2603, 2610.2, 2702, 2703, 2705, 2708, 2709, 2801, 2803, 2805, 2902.1, 2926, 2929, 7018, 7303, 7304	The direction in which the arrow or arrows point may be varied.
13.	515, 515.1, 553, 557.3, 557.4, 573, 606, 638.1, 639, 640, 640.2A, 644, 788, 810, 962, 962.1, 962.2, 2316, 2610.1, 2711, 5013, 5014, 7104	The direction of the arrow or chevron may be varied with the arrow or chevron pointing horizontally to the left or to the right. The arrow may also point vertically upwards.
14.	557.4, 638.1, 639, 640, 640.2A, 780.1, 962, 962.1, 962.2, 2316	The arrow may be omitted from the sign.
15.	832.9, 2026, 2027, 2125, 2126, 2132, 2134, 2136, 2137, 2203, 2204, 2207, 2208, 2211, 2212, 2214, 2302, 2304, 2306, 2309, 2312, 2315, 2317, 2318, 2320, 2321, 2322, 2323, 2504, 2507, 2508, 2602, 2604, 2605, 2606,	The direction in which the sign points may be reversed.

*Status: This is the original version (as it was originally made). This item of legislation is currently only available in its original format.*

(1) <i>Item</i>	(2) <i>Diagram numbers</i>	(3) <i>Permitted variant</i>
	2607, 2608, 2609, 2610, 2701, 2704, 2707, 2710, 2713, 2802, 2804, 2806, 2807, 2902, 2921, 7305	
16.	817, 817.2, 868, 868.1, 872, 873, 874, 875, 877, 960, 960.1, 2001, 2002, 2003, 2004, 2005, 2007, 2008, 2009, 2010, 2017, 2018, 2019, 2021, 2022, 2023, 2024, 2025, 2029, 2033, 2101, 2102, 2103, 2104, 2105, 2106, 2107, 2108, 2109, 2110, 2111, 2112, 2113, 2113.1, 2114, 2115, 2115.1, 2117, 2118, 2119, 2120, 2121, 2122, 2123, 2124, 2127, 2216, 2505, 2509, 2705, 2706, 2803, 2805, 2904, 2904.1, 2909, 2913, 2914, 2925, 2926, 6006, 6006.1, 6008, 6009, 6009.1, 6009.2, 7201, 7202, 7203, 7203.1, 7204, 7205, 7206, 7207, 7210, 7211, 7212, 7213, 7214, 7215, 7216, 7217, 7218, 7220, 7221, 7230, 7231, 7232, 7233, 7234, 7235, 7236, 7237, 7238, 7239, 7240, 7250, 7251, 7252, 7253, 7254, 7255, 7306, 7402	Route symbols, or the number of arrows, or symbols indicating which lanes are open or closed to traffic, may be varied.
17.	504.1, 506.1, 507.1	The thickness of the route symbols may be varied to indicate which is the major road at the junction ahead.
18.	2001, 2002, 2004, 2007, 2008, 2009, 2010, 2022, 2023, 2024, 2025, 2033, 2101, 2102, 2104, 2105, 2108, 2109, 2110, 2112, 2113, 2113.1, 2118, 2119, 2120, 2121, 2122, 2123, 2124, 2913, 2914, 2925	The thickness of the route symbols may be varied to reflect the status of the routes indicated.
19.	674, 1035, 2001, 2002, 2003, 2004, 2005, 2006, 2007, 2008, 2009, 2010, 2011, 2012, 2013, 2014, 2015, 2016, 2017, 2018, 2019, 2020, 2021, 2022, 2023, 2024, 2025, 2026, 2027, 2028, 2029, 2030, 2030.1, 2033, 2034, 2101, 2101.1, 2101.2, 2102, 2103, 2104, 2105, 2106, 2107, 2108, 2109, 2110, 2111,	The destination, other place name or junction name shown may be varied. The words “Other routes” or “Ring road” may be substituted for the destination. The phrases “via toll road”, “Byway to” and “Single track road” may be used in addition to the destination.



**Status:** This is the original version (as it was originally made). This item of legislation is currently only available in its original format.

(1) <i>Item</i>	(2) <i>Diagram numbers</i>	(3) <i>Permitted variant</i>
	2112, 2113, 2113.1, 2114, 2115, 2115.1, 2116, 2117, 2118, 2119, 2120, 2121, 2122, 2123, 2124, 2125, 2126, 2127, 2128, 2131, 2132, 2133, 2134, 2138, 2201, 2202, 2203, 2206, 2207, 2209, 2210, 2211, 2213, 2214, 2215, 2216, 2308, 2309, 2401, 2402, 2403, 2509, 2601, 2602, 2605, 2607, 2608, 2610.1, 2701, 2705, 2706, 2707, 2803, 2804, 2806, 2807, 2902, 2903, 2904, 2904.1, 2905, 2906, 2908, 2909, 2911, 2913, 2914, 2915, 2917, 2919, 2920, 2924, 2925, 2926, 2927, 2928, 2929	
20.	2001, 2002, 2003, 2004, 2005, 2006, 2007, 2008, 2009, 2010, 2011, 2012, 2013, 2014, 2015, 2016, 2017, 2018, 2019, 2020, 2021, 2022, 2023, 2024, 2025, 2026, 2027, 2028, 2029, 2030, 2030.1, 2031, 2033, 2034, 2101, 2101.1, 2101.2, 2102, 2103, 2104, 2105, 2106, 2107, 2108, 2109, 2110, 2111, 2112, 2113, 2113.1, 2114, 2115, 2115.1, 2116, 2117, 2118, 2119, 2120, 2121, 2122, 2125, 2126, 2127, 2128, 2129, 2131, 2132, 2138, 2705, 2706, 2707, 2716, 2805, 2806, 2901, 2902, 2902.1, 2903, 2904, 2904.1, 2905, 2906, 2908, 2909, 2910, 2910.1, 2911, 2912, 2913, 2914, 2915, 2917, 2918, 2929, 7001.2, 7002, 7220, 7233, 7240, 7285, 7286	<p>Identification numbers of routes may be added where not shown. The identification numbers of any route may be varied or omitted.</p> <p>A compass point (“North”, “South”, “East” or “West”) may be added to the route number, shown in brackets in the same colour as the route number. Superseded route numbers may be retained provided they are cancelled with a diagonal red bar.</p> <p>Any motorway junction numbers may be varied or omitted. The junction number may be shown in either the bottom left hand or top left hand corner of a sign on a motorway.</p> <p>The emergency diversion route symbols shown in Part VII of Schedule 13 may be added.</p>
21.	2001, 2002, 2003, 2004, 2005, 2007, 2008, 2009, 2011, 2012, 2013, 2014, 2015, 2016, 2017, 2018, 2019, 2020, 2021, 2022, 2023, 2024, 2025*, 2026*, 2027*, 2028*, 2029, 2031*,	(a) (a) Where a route leads directly onto a motorway, route number, destinations and motorway symbol shall be

**Status:** This is the original version (as it was originally made). This item of legislation is currently only available in its original format.

(1) <i>Item</i>	(2) <i>Diagram numbers</i>	(3) <i>Permitted variant</i>
	2033, 2101, 2101.1, 2101.2, 2102, 2103, 2104, 2105, 2106, 2107, 2108, 2109, 2110, 2111, 2112, 2113, 2113.1, 2114, 2115, 2115.1, 2116, 2117, 2118, 2119, 2120, 2121*, 2122*, 2123*, 2124*, 2125*, 2126*, 2127*, 2128*, 2129*, 2131*, 2132*, 2138*, 2805*, 2806*, 2913*, 2914*	<p>shown in white on a blue panel and the motorway junction number may be shown in white on a black patch on the blue panel in the manner shown in diagrams 2023 and 2104.</p> <p>(b) Where the route leads indirectly to a motorway, the motorway route number with or without a compass point (“North”, “South”, “East” or “West”) shall be shown in brackets in white on a blue patch. The blue patch shall have a white border on signs with green or black backgrounds.</p> <p>(c) The emergency diversion route symbols shown in Part VII of Schedule 13 may be added.</p>
22.	2101, 2101.1, 2101.2, 2102, 2103, 2104, 2105, 2106, 2107, 2108, 2109, 2110, 2111, 2112, 2113, 2113.1, 2114, 2115, 2115.1, 2116, 2117, 2118, 2119, 2120, 2121, 2122, 2123*, 2124*, 2125*, 2126*, 2127, 2128*, 2131*, 2132*, 2138*, 2805*, 2806*, 2913, 2914	<p>(a) (a) Where a route leads directly onto a primary route, the destinations shall appear in white letters and the route number in yellow both on a green panel. The green panel shall have a white border on signs with blue backgrounds.</p> <p>(b) Where a route leads indirectly to a primary route, the route number with or without</p>
	<p>*Permitted variant (a) does not apply to these signs.</p>	

**Status:** This is the original version (as it was originally made). This item of legislation is currently only available in its original format.

(1) <i>Item</i>	(2) <i>Diagram numbers</i>	(3) <i>Permitted variant</i>
		<p>a compass point (“North”, “South”, “East” or “West”) shall be shown in brackets in yellow on a green patch. The green patch shall have a white border on signs with black backgrounds.</p> <p>(c) The emergency diversion route symbols shown in Part VII of Schedule 13 may be added.</p>
23.	2001, 2002, 2003, 2004, 2005, 2006, 2007, 2008, 2009, 2010, 2011, 2012, 2013, 2014, 2015, 2016, 2017, 2018, 2019, 2020, 2021, 2022, 2023, 2024, 2025, 2029, 2033, 2913, 2914	Where a route leads directly onto a non-primary route, the destination, and route number if appropriate, shall appear in black letters on a white panel.
24.	2001, 2002, 2003, 2004, 2005, 2006, 2007, 2008, 2009, 2010, 2011, 2012, 2013, 2014, 2015, 2016, 2017, 2018, 2019, 2022, 2023, 2024, 2025, 2026, 2027, 2028, 2029, 2033, 2101, 2101.1, 2101.2, 2102, 2103, 2104, 2105, 2106, 2108, 2110, 2111, 2113, 2114, 2115, 2115.1, 2118, 2119, 2120, 2121, 2122, 2123, 2124, 2125, 2126, 2127, 2203, 2607, 2913, 2914	A symbol shown in Schedule 14, or the name of a tourist attraction, or such a symbol and such a name together may be shown in white on a brown panel. The direction in which the symbol faces and the relative positions of the symbol and name shall be reversed as necessary. The brown panel shall have a white border on signs with green or blue backgrounds.
25.	2001, 2002, 2003, 2004, 2005, 2006, 2008, 2009, 2010, 2011, 2012, 2013, 2014, 2015, 2016, 2017, 2018, 2019, 2022, 2023, 2024, 2026, 2027, 2028, 2029, 2033, 2101, 2101.1, 2101.2, 102, 2103, 2104, 2105, 2106, 2107, 2108, 2109, 2110, 2111, 2112, 2113, 2113.1, 2114, 2115, 2115.1, 2118, 2119, 2122, 2123, 2124, 2127, 2913, 2914	The white lorry symbol shown in diagram 2805 may be incorporated on a black panel to indicate a route recommended for goods vehicles. The lorry symbol may be reversed. The black panel shall have a white border on signs with green or blue backgrounds.

**Status:** This is the original version (as it was originally made). This item of legislation is currently only available in its original format.

(1) <i>Item</i>	(2) <i>Diagram numbers</i>	(3) <i>Permitted variant</i>
26.	2001, 2002, 2003, 2004, 2005, 2006, 2007, 2008, 2009, 2010, 2011, 2012, 2013, 2014, 2015, 2016, 2017, 2018, 019, 2022, 2023, 2024, 2026, 2027, 2028, 2029, 2033, 2101, 2101.1, 2101.2, 2102, 2103, 2104, 2105, 2106, 2107, 2108, 2109, 2110, 2111, 2112, 2113.1, 2114, 2115, 2115.1, 2118, 2119, 2120, 2122, 2123, 2124, 2127, 2913, 2914	Directions to a Ministry of Defence establishment may be shown, with destinations appearing in black letters on a white panel with a red border as shown in diagram 2113. There shall be a white rim round the red border on signs with green or blue backgrounds.
27.	2001, 2002, 2003, 2004, 2005, 2006, 2007, 2008, 2009, 2010, 2017, 2018, 2019, 2022, 2023, 2024, 2033, 2101, 2101.1, 2101.2, 2102, 2103, 2104, 2107, 2108, 2109, 2110, 2111, 2112, 2113, 2113.1, 2114, 2115, 2115.1, 2118, 2119, 2120, 2122, 2123, 2124, 2127	A route recommended for pedal cyclists may be shown, with destinations appearing in white letters together with a white cycle symbol on a blue panel as shown in diagram 2105. The blue panel shall have a white border on signs with a green background.
28.	505.1, 506.1, 507.1, 512, 512.1, 512.2, 513, 517, 559, 609, 789, 789.1, 789.2, 823, 824, 825, 950, 962, 962.1, 962.2, 963, 963.1, 963.2, 1039, 1057, 2004, 2005, 2007, 2105, 2106, 2107, 2108, 2109, 2112, 2113, 2113.1, 2120, 2135, 2136, 2137, 2201, 2202, 2206, 2207, 2208, 2215, 2216, 2316, 2317, 2318, 2319, 2320, 2321, 2322, 2323, 2503, 2504, 2505, 2506, 2507, 2508, 2601, 2602, 2603, 2604, 2605, 2606, 2607, 2608, 2609, 2610, 2610.1, 2711, 2713.1, 2805, 2806, 2925, 2926, 2929, 6003, 7221	The symbol may be reversed. Where a bus symbol faces left a door shall be shown at the front of that side; when the symbol is reversed to face right a window shall be substituted for the door.
29.	2003, 2004, 2005, 2027, 2105, 2106, 2107, 2109, 2111, 2112, 2113, 2113.1, 2118, 2119, 2133, 2134, 2137, 2202, 2204, 2210, 2211, 2213, 2214, 2215, 2216, 2304, 2306, 2317, 2318, 2320, 2321, 2322, 2601, 2602, 2603, 2604, 2605, 2606, 2607, 2608, 2609, 2610, 2701, 2801, 2802, 2902, 2902.1, 2926	The relative positions of the symbol and other legend may be reversed.

**Status:** This is the original version (as it was originally made). This item of legislation is currently only available in its original format.

(1) <i>Item</i>	(2) <i>Diagram numbers</i>	(3) <i>Permitted variant</i>
30.	2001, 2002, 2003, 2004, 2005, 2006, 2007, 2008, 2009, 2010, 2012, 2013, 2014, 2015, 2016, 2017, 2018, 2019, 2020, 2021, 2022, 2024, 2026, 2027, 2028, 2029, 2030, 2030.1, 2033, 2034, 2101, 2101.1, 2101.2, 2102, 2103, 2104, 2105, 2106, 2107, 2108, 2109, 2110, 2111, 2112, 2113, 2113.1, 2114, 2115, 2115.1, 2116, 2117, 2118, 2120, 2122, 2123, 2124, 2125, 2126, 2127, 2128, 2138, 2605, 2705, 2706, 2707, 2902, 2903, 2904, 2904.1, 2905, 2906, 2908, 2909, 2911, 2913, 2914, 2915	The aircraft symbol shown in diagram 2011 may be incorporated either with or without the name of an airport. The direction in which the symbol points may be varied. The symbol shall be coloured white when placed on a green or blue background and be coloured black when placed on a white or yellow background.
31.	2001, 2002, 2003, 2004, 2005, 2006, 2007, 2008, 2009, 2011, 2012, 2013, 2014, 2015, 2016, 2017, 2018, 2019, 2022, 2023, 2024, 2025, 2026, 2027, 2028, 2029, 2033, 2101, 2101.1, 2101.2, 2102, 2103, 2104, 2105, 2106, 2107, 2108, 2109, 2110, 2111, 2112, 2113, 2113.1, 2114, 2115, 2115.1, 2118, 2119, 2120, 2121, 2122, 2125, 2126, 2127, 2202, 2203, 2913, 2914, 2925, 2926	A sign shown in diagram 523.1, 524.1, 528, 529, 530, 554 (“Ford” or “Gate”), 612, 613, 616, 617 (with 618.1 “No vehicles”), 619, 619.1, 619.2, 622.1A (with symbol reversed where appropriate), 622.5 (with symbol reversed where appropriate), 626.2 (prohibitory roundel only), 629, 629.1 (with symbol reversed where appropriate), 629.2, 629.2A, 770, 771, 772, 779, the red bar shown in 816, 952 (with symbol reversed where appropriate), 953 (with 953.2) or 953.1 (with 953.2) may be incorporated as a symbol, and the plate shown in diagram 572 may also be incorporated as a panel beneath the symbol to indicate the distance to the hazard or prohibition indicated by the symbol.  A white border shall be added round the red triangle or roundel and the black border omitted from the plate shown in diagram 572 when the symbol or plate are placed on a green, brown or blue

**Status:** This is the original version (as it was originally made). This item of legislation is currently only available in its original format.

(1) <i>Item</i>	(2) <i>Diagram numbers</i>	(3) <i>Permitted variant</i>
32.	2001, 2002, 2003, 2004, 2005, 2006, 2007, 2008, 2009, 2014, 2015, 2016, 2017, 2018, 2019, 2022, 2023, 2024, 2025, 2026, 2027, 2028, 2029, 2033, 2101, 2101.1, 2101.2, 2102, 2103, 2104, 2105, 2106, 2107, 2108, 2109, 2110, 2111, 2112, 2113, 2113.1, 2114, 2115, 2115.1, 2118, 2119, 2120, 2121, 2122, 2125, 2126, 2127, 2131, 2132, 2202, 2203, 2913, 2914, 2925, 2926	<p>background on that part of the sign. Such a sign may be omitted from a diagram where it is shown.</p> <p>The following legend may be incorporated to show the route avoiding a hazard or prohibition indicated by the appropriate symbol referred to in item 31—</p> <p>“avoiding steep hill”;</p> <p>“avoiding swing bridge”;</p> <p>“avoiding lifting bridge”;</p> <p>“avoiding low bridge”;</p> <p>“avoiding weak bridge”;</p> <p>“avoiding ford”;</p> <p>“avoiding gated road”;</p> <p>“avoiding toll road”;</p> <p>“avoiding town centre”;</p> <p>“avoiding level crossing”;</p> <p>“alternative route for goods vehicles”;</p> <p>“alternative route for light vehicles only”;</p> <p>“alternative route for heavy vehicles”;</p> <p>“alternative route for high vehicles”;</p> <p>“alternative route for long vehicles”.</p>
33.	2004, 2005, 2107, 2109, 2112, 2113.1, 2201, 2202, 2206, 2207, 2208, 2209, 2210, 2211, 2212, 2213, 2214, 2215, 2216, 2608, 2924, 2925, 2926, 2927	<p>The symbol denoting the type of tourist attraction may be omitted or varied to any one of the symbols shown in Schedule 14 or other</p>

**Status:** This is the original version (as it was originally made). This item of legislation is currently only available in its original format.

(1) <i>Item</i>	(2) <i>Diagram numbers</i>	(3) <i>Permitted variant</i>
34.	<p>2001, 2002, 2003, 2004, 2005, 2006, 2007, 2008, 2009, 2010, 2011, 2012, 2013, 2014, 2015, 2016, 2017, 2018, 2019, 2020, 2021, 2022, 2023, 2024, 2025, 2026, 2027, 2028, 2029, 2033, 2034, 2101, 2101.1, 2101.2, 2102, 2103, 2104, 2105, 2106, 2107, 2108, 2109, 2110, 2111, 2112, 2113, 2113.1, 2114, 2115, 2115.1, 2116, 2117, 2118, 2119, 2120, 2121, 2122, 2123, 2124, 2125, 2126, 2127, 2138, 2202, 2203, 2601, 2602, 2605, 2607, 2903*, 2904*, 2904.1*, 2905*, 2906*, 2908*, 2909*, 2913, 2914, 2915*</p> <p>*In respect of symbol No.1 only.</p>	<p>approved symbol, except that the symbols shown in diagrams T4 (picnic area), T5 (youth hostel), T6 (caravan park) and T7 (camping site) shall not be used on a motorway. The symbol shall be reversed where appropriate.</p> <p>The following symbols (shown in the manner specified) may be substituted for or added to the place name—</p> <ol style="list-style-type: none"> <li>1. The white on red double arrow symbol indicating British Railways shown in diagram 2134. A white border shall be added round the symbol when placed on a green, brown or blue background on that part of the sign.</li> <li>2. The red circle and crossbar indicating London Transport shown in diagram 2133. The symbol shall be shown on a white rectangular patch when placed on a green, brown or blue background on that part of the sign.</li> <li>3. A symbol representing a Passenger Transport Executive. Where necessary a white border or rectangular patch may be used to ensure adequate contrast between the colour of the symbol and the background of that part of the sign.</li> <li>4. The parking symbol shown in diagram 2505. A white border shall be added round the blue symbol when placed on a green or brown background on that part of the sign.</li> <li>5. The telephone symbol shown in diagram 2322. The symbol shall be coloured black when placed on a white or yellow background and be</li> </ol>

**Status:** This is the original version (as it was originally made). This item of legislation is currently only available in its original format.

(1) <i>Item</i>	(2) <i>Diagram numbers</i>	(3) <i>Permitted variant</i>
		<p>coloured white when placed on a green, brown or blue background on that part of the sign.</p> <p><b>6.</b> The disabled person symbol shown in diagram 2323. The symbol shall be coloured black when placed on a white or yellow background and be coloured white when placed on a green, brown or blue background on that part of the sign.</p> <p><b>7.</b> The “WC” symbol denoting toilets shown in diagram 2323. The symbol shall be coloured black when placed on a white or yellow background and be coloured white when placed on a green, brown or blue background on that part of the sign.</p> <p><b>8.</b> The “H” symbol and associated plate denoting hospital shown in diagram 827.1 or 827.2. The associated plate may be placed either below or to the right of the “H” symbol. A white border shall be added round the blue or red symbol when placed on a green background on that part of the sign.</p> <p><b>9.</b> The ferry boat symbol shown in diagram 2007 or 2120 as appropriate. The symbol shall be coloured black with white vehicles when placed on a white or yellow background and be coloured white with black vehicles when placed on a green, brown, black or blue background on that part of the sign.</p> <p><b>10.</b> The white on blue “Park and Ride” symbol shown in diagram 2503 with the words “Park and Ride”. A white</p>



**Status:** This is the original version (as it was originally made). This item of legislation is currently only available in its original format.

(1) <i>Item</i>	(2) <i>Diagram numbers</i>	(3) <i>Permitted variant</i>
35.	2001, 2002, 2003, 2007, 2008, 2009, 2011, 2012, 2015, 2016, 2017, 2019, 2020, 2022, 2024, 2025, 2033, 2101, 2101.1, 2101.2, 2102, 2103, 2104, 2004, 2005, 2013, 2021, 2023 or 2105, 2106, 2107, 2108, 2109, 2111, 2110 2112, 2113, 2113.1, 2114, 2115, 2116, 2117, 2118, 2119, 2120, 2121	border shall be added round the blue symbol when placed on a green or brown background on that part of the sign.  The name of the junction may be indicated in a panel at the top of the sign as shown in diagram provided a place name is not indicated as described in item 36.
36.	2001, 2002, 2003, 2004, 2005, 2008, 2009, 2017, 2019, 2022, 2023, 2024, 2033, 2101, 2102, 2103, 2104, 2105, 2106, 2107, 2108, 2109, 2110, 2111, 2112, 2113, 2113.1, 2114, 2115, 2118, 2119, 2120	Where the sign is situated at or near the boundary of a town, village or suburb, the name alone of that town, village or suburb may be indicated in a panel at the top of the sign as shown in diagram 2007, provided that a junction name is not shown. Where the sign is not on a primary route the name shall be in black letters on a white background.
37.	618, 618.1, 618.2, 618.3, 637.2, 637.3, 638.1, 639, 639.1A, 640, 640.2A, 640.3, 640.4, 642.2, 646, 650.1, 650.2, 660.5, 661.1, 662, 663, 663.1, 665, 667.1, 668.1, 961, 972, 974, 975, 2507, 7003, 7005, 7007	References to the time of day, the day of the week, the month of the year, or the year may be varied.
38.	618.2, 618.3, 620, 620.1, 660, 660.3, 660.4, 661, 661.2, 661.3, 962, 962.1, 962.2, 2505, 2506, 2507, 2508	A reference to the time of day, the day of the week or the month of the year may be added.
39.	7003, 7006, 7007	The words “Department of Transport” or “The Department of Transport” may be varied to “The Highways Agency”, “The Welsh Office”, “The Scottish Office” or the name of the appropriate traffic authority in England or Wales or roads authority in Scotland and the

**Status:** This is the original version (as it was originally made). This item of legislation is currently only available in its original format.

(1) <i>Item</i>	(2) <i>Diagram numbers</i>	(3) <i>Permitted variant</i>
40.	781	Department of Transport logo varied accordingly.  The number of bells may be increased or decreased according to the width of the road over which the sign is placed. The colour of the bells may be varied.
41.	7201, 7210, 7211, 7212, 7213, 7214, 7215, 7216, 7217, 7218, 7220, 7221, 7230, 7231, 7232, 7233, 7234, 7235, 7236, 7237, 7238, 7239, 7240	The symbols or other legends shown in diagrams 7280 to 7288 may be incorporated or omitted.
42.	515.1, 515.1A	The number of elements making up the sign face may be varied.

## SCHEDULE 17

Regulations 18, 19

## ILLUMINATION OF SIGNS

(1) <i>Item</i>	(2) <i>Diagram numbers</i>	(3) <i>Method of Illumination</i>
1.	501, 504.1, 505.1, 506.1, 507.1, 510, 512, 512.1, 512.2, 513, 516, 517, 520, 521, 522, 523.1, 524.1, 528, 529, 529.1, 530, 531.1, 532.2 (in respect of the triangle symbols), 532.3 (in respect of the triangle symbols), 543 (other than when used with 547.6), 544 (other than when used with 547.5), 544.1, 544.2, 545, 555, 601.1, 602, 606 (other than when used as described in item 6 or item 7), 609, 610 (other than when used as described in item 7), 611 (other than when used as described in item 7), 611.1, 612 (other than when used as described in item 6), 613 (other than when used as described in item 6), 614 (other than when used as described in item 6), 615, 616 (other	(1) Where the sign is erected on a road within 50 metres of any lamp lit by electricity which forms part of a system of street-lighting furnished by means of at least three such lamps placed not more than 183 metres apart, that sign shall be illuminated by a means of internal or external lighting either for so long as that system is illuminated, or throughout the hours of darkness, unless it is erected temporarily for any of the following reasons—  (a) for the purpose of a temporary statutory provision;  (b) by reason of some emergency; or  (c) if that road is a road subject to a speed

**Status:** This is the original version (as it was originally made). This item of legislation is currently only available in its original format.

(1) <i>Item</i>	(2) <i>Diagram numbers</i>	(3) <i>Method of Illumination</i>
	than when used as described in item 7), 617 (other than when used with 618), 618.2, 618.3, 618.3A, 618.4, 619, 619.1, 619.2, 622.1A, 622.2, 622.4, 626.2, 629, 629.1, 629.2, 629.2A, 632, 642 (if the diameter is more than 450mm), 652, 669, 669.1, 770, 771, 772, 779, 782, 784, 790, 818, 818.1, 818.1A, 868, 868.1, 872, 873, 874, 875, 950 (other than when used with 950.1), 952, 953, 953.1, 2901, 2902, 2902.1, 2903, 2904, 2904.1, 2905, 2906, 2908, 2909, 2910, 2910.1, 2911, 2912, 2915, 2917, 2918, 2919, 2920, 2921, 2929, 2930, 2931, 5010, 5011, 7001, 7002, 7004, 7005, 7006, 7009, 7010, 7011, 7012, 7013, 7201, 7202, 7203, 7203.1, 7204, 7205, 7206, 7207, 7210, 7211, 7212, 7213, 7214, 7215, 7216, 7217, 7218, 7220, 7221, 7230, 7231, 7232, 7233, 7234, 7235, 7236, 7237, 7238, 7239, 7240, 7250, 7251, 7252, 7253, 7254, 7255, 7260, 7261, 7262, 7263, 7264, 7265, 7266, 7270, 7271, 7272, 7273, 7274, 7275, 7290	limit of 30 mph or under, by reason of the execution of works, or of any obstruction on the road.  (2) Where any such sign is erected in such a manner that it is not required to be illuminated throughout the hours of darkness by a means of internal or external lighting, it shall be illuminated by the use of retroreflecting material in accordance with the provisions of regulation 19.
2.	2711	The sign shall be internally illuminated.
3.	955 (other than when used as described in item 7), 956, 957	(1) Where the sign is a terminal sign and is erected on a road within 50 metres of any lamp lit by electricity which forms part of a system of street-lighting furnished by means of at least three such lamps placed not more than 183 metres apart, that sign shall be illuminated by a system is illuminated, or throughout the hours of darkness.  (2) Where the sign is erected in such a manner that it is not required to

**Status:** This is the original version (as it was originally made). This item of legislation is currently only available in its original format.

(1) <i>Item</i>	(2) <i>Diagram numbers</i>	(3) <i>Method of Illumination</i>
4.	515, 515.1, 515.1A, 528.1, 548, 549, 550, 550.1, 551, 551.1, 551.2, 552, 553.1, 554, 554.1, 554.2, 556, 556.1, 557, 558, 558.1, 559, 562, 574, 581, 582, 583, 633, 642 (if the diameter is 450mm or less), 646, 647, 663, 663.1, 664, 665, 666, 774, 775, 777, 783, 785, 786, 787, 788, 789, 789.1, 789.2, 801, 811, 816, 817, 820, 821, 822, 823, 824, 825, 827.1, 827.2, 829.1, 829.2, 829.3, 829.4, 830, 830.1, 830.2, 830.3, 831, 831.1, 832, 832.1, 832.2, 832.3, 832.4, 832.5, 832.6, 832.7, 832.8, 832.9, 832.10, 877, 950 (when used with 950.1), 951, 958, 958.1, 959, 959.1, 960, 960.1, 962, 962.1, 962.2, 964, 969, 2001, 2002, 2003, 2004, 2005, 2006, 2007, 2008, 2009, 2010, 2011, 2012, 2013, 2014, 2015, 2016, 2017, 2018, 2019, 2020, 2021, 2022, 2023, 2024, 2025, 2026, 2027, 2028, 2029, 2030, 2030.1, 2031, 2032, 2033, 2034, 2101, 2101.1, 2101.2, 2102, 2103, 2104, 2105, 2106, 2107, 2108, 2109, 2110, 2111, 2112, 2113, 2113.1, 2114, 2115, 2115.1, 2116, 2117, 2118, 2119, 2120, 2121, 2122, 2123, 2124, 2125, 2126, 2127, 2128, 2129, 2130, 2131, 2132, 2133, 2134, 2135, 2136, 2137, 2138, 2301, 2302, 2303, 2304, 2305, 2306, 2307, 2308, 2309, 2310, 2311, 2312, 2312.1, 2313, 2314, 2315, 2315.1, 2501, 2502, 2503, 2504, 2505, 2506, 2507, 2508, 2509, 2702,	<p>be illuminated throughout the hours of darkness by a means of internal or external lighting, it shall be illuminated by the use of retroreflecting material in accordance with the provisions of regulation 19.</p> <p>The sign may be illuminated by a means of internal or external lighting but if not so illuminated throughout the hours of darkness, it shall be illuminated by the use of retroreflecting material in accordance with the provisions of regulation 19.</p>

**Status:** This is the original version (as it was originally made). This item of legislation is currently only available in its original format.

(1) <i>Item</i>	(2) <i>Diagram numbers</i>	(3) <i>Method of Illumination</i>
	2703, 2704, 2705, 2706, 2707, 2708, 2709, 2710, 2713.1, 2716, 2803, 2804, 2805, 2806, 2913, 2914, 2916, 2922, 2923, 2924, 2925, 2926, 2927, 2928, 2932, 5012, 5013, 5014, 5015, 7003, 7014, 7015, 7019, 7020, 7104, 7105, 7301, 7302, 7303, 7304, 7305, 7306, 7307	
5.	543 (when used with 547.6), 544 (when used with 547.5), 557.1, 7023, 7024, 7401, 7402, 7403	The sign shall be illuminated by a means of internal or external lighting throughout the hours of darkness.
6.	606, 612, 613, 614	Where the sign is fixed to light signals prescribed by regulation 30, or by regulation 30 as varied by regulation 31, it shall be illuminated by a means of internal lighting at all times except when the light signals to which it is fixed are being maintained or repaired.
7.	606, 610, 611, 616, 955	Where the sign is mounted in a bollard fitted with a means of lighting it internally, the sign shall be illuminated throughout the hours of darkness by that means of internal lighting.
8.	502, 503, 511, 513.1, 513.2, 518, 519, 525, 526, 527, 530.1, 531.2, 543.1, 546, 547.1, 547.2, 547.3, 547.4, 547.5, 547.6, 547.7, 548.1, 553, 553.2, 554.3, 556.2, 557.2, 557.3, 557.4, 558.2, 563, 563.1, 570, 572, 573, 575, 583.1, 607, 608, 615.1, 618, 618.1, 620, 620.1, 627.1, 643, 644, 645, 773, 778, 778.1, 780, 780.1, 780.2, 804.1, 804.2, 804.3, 811.1, 817.2, 876, 950.1, 953.2, 954, 954.1, 954.2, 954.3, 954.4, 961, 7001.1, 7001.2, 7021, 7022, 7208, 7209, 7256, 7401.1	See regulation 20.
9.	530.2, 532.2 and 532.3 in respect of parts of the	The sign or plate may be left unlit, or be illuminated

**Status:** This is the original version (as it was originally made). This item of legislation is currently only available in its original format.

(1) <i>Item</i>	(2) <i>Diagram numbers</i>	(3) <i>Method of Illumination</i>
	signs other than the triangle symbols, 617 when used with 618, 622.5, 622.6, 625.1, 636, 636.1, 637, 637.1, 637.2, 637.3, 638, 638.1, 639, 639.1A, 640, 640.1, 640.2A, 640.3, 640.4, 640.5, 642.2, 642.3, 650.1, 650.2, 651, 660, 660.3, 660.4, 660.5, 661, 661.1, 661.2, 661.3, 661.4, 662, 667, 667.1, 667.2, 668, 668.1, 668.2, 810, 814.1, 814.2, 814.3, 814.4, 816.1, 826, 826.1, 833, 834, 835, 836, 857, 857.1, 864, 865, 963, 963.1, 963.2, 963.3, 965, 966, 967, 968, 968.1, 970, 971, 972, 973, 973.1, 974, 975, 2201, 2202, 2203, 2204, 2205, 2206, 2207, 2208, 2209, 2210, 2211, 2212, 2213, 2214, 2215, 2216, 2316, 2317, 2318, 2319, 2320, 2321, 2322, 2323, 2401, 2402, 2403, 2601, 2602, 2603, 2604, 2605, 2606, 2607, 2608, 2609, 2610, 2610.1, 2610.2, 2701, 2712, 2713, 2801, 2802, 2807, 7007, 7008, 7016, 7017, 7018, 7404	either by means of internal or external lighting or by the use of retroreflecting material.
10.	670, 671, 672, 673 (if the diameter is 600mm, 900mm or 1500mm)	(1) Where the sign is a terminal sign and is erected on a trunk or principal road within 50 metres of a street lamp lit by electricity, it shall throughout the hours of darkness— <ul style="list-style-type: none"> <li data-bbox="1050 1559 1348 1809">(a) be continuously illuminated by means of internal or external lighting and may also be illuminated by the use of retroreflecting material; or</li> <li data-bbox="1050 1823 1348 2011">(b) while the street lamp is lit, be continuously illuminated by means of external lighting and shall also be illuminated by the</li> </ul>

**Status:** This is the original version (as it was originally made). This item of legislation is currently only available in its original format.

(1) Item	(2) Diagram numbers	(3) Method of Illumination
		<p>use of retroreflecting material.</p> <p>(2) If any sign is required to be illuminated in the manner and at the times described in paragraph (1) above—</p> <p>(a) every sign shown in the same diagram as the first-mentioned sign which is erected at or near the same point on the road or the same junction for the same purpose as the first-mentioned sign shall be continuously illuminated throughout the same period by the same means of lighting as the first-mentioned sign; and</p> <p>(b) if any of the signs is illuminated by the use of retroreflecting material, every other such sign shall be similarly illuminated.</p>
11.	670, 671, 672, 673, 674, 675	<p>If the sign is not required by item 10 to be illuminated by lighting throughout the hours of darkness or throughout such hours while a street lamp is lit, it may be illuminated—</p> <p>(a) throughout the hours of darkness by means of internal or external lighting; or</p> <p>(b) throughout any period during the hours of darkness by the use of retroreflecting material; and if so illuminated paragraph (2) of item 10 shall apply as if the sign were a sign required by paragraph (1) of item 10 to be illuminated by lighting throughout the hours</p>

**Status:** This is the original version (as it was originally made). This item of legislation is currently only available in its original format.

(1) <i>Item</i>	(2) <i>Diagram numbers</i>	(3) <i>Method of Illumination</i>
12.	1001, 1002.1, 1003, 1003.1, 1003.2, 1003.3, 1003.4, 1004, 1004.1, 1005, 1005.1, 1008, 1008.1, 1009, 1010, 1012.1, 1012.2, 1012.3, 1013.1, 1013.3, 1014, 1017, 1018.1, 1019, 1020.1, 1022, 1023, 1024, 1024.1, 1025, 1025.1, 1025.2, 1025.3, 1026, 1026.1, 1027.1, 1028.2, 1028.3, 1028.4, 1029, 1032, 1033, 1035, 1036.1, 1036.2, 1037.1, 1038, 1039, 1040, 1040.2, 1040.3, 1040.4, 1040.5, 1041, 1042, 1043, 1044, 1045, 1046, 1048, 1048.1, 1049, 1049.1, 1050, 1055, 1057, 1058, 1059, 1060, 1060.1, 1061, 1061.1, 1063	See regulation 28.
13.	560, 561	See regulation 21.
14.	776	The sign shall be illuminated by an intermittent red light flashing at a rate of not less than 54 nor more than 90 flashes per minute.
15.	515.2, 532.2, 605.2, 2714, 2715, 3014 (in respect of the backing board)	The parts of the sign coloured other than black or orange shall be illuminated by the use of retroreflecting material in accordance with the provisions of regulation 19. Any parts of the sign coloured orange may be so illuminated. The part of the sign in diagram 605.2 coloured yellow shall be fluorescent, except as provided in regulation 19(4).
16.	7101, 7102, 7103	See regulation 44.

## SCHEDULE 18

Regulation 4

## INTERPRETATION OF “UNLADEN VEHICLE”

1. In these Regulations “unladen vehicle” means, subject to paragraph 3 of this Schedule—



(a) a motor vehicle not drawing a trailer or otherwise forming part of a combination of vehicles; or  
(b) a combination of vehicles comprising one motor vehicle drawing one or more trailers,  
in relation to which the conditions specified in paragraph 2 below are satisfied.

2. The conditions mentioned in paragraph 1 above are—

- (a) that the motor vehicle is a motor car, a heavy motor car, or a motor tractor;
- (b) that no goods or burden are being carried in the motor vehicle or if the motor vehicle is drawing one or more trailers, in that combination of vehicles; and
- (c) that not more than 2 persons (excluding the driver) are being carried in the motor vehicle or, if the motor vehicle is drawing one or more trailers, in that combination of vehicles.

3. For the purposes of this Schedule—

- (a) in the case of a motor vehicle so constructed that it is fitted with a crane, dynamo, plant or other special appliance or apparatus which is a permanent or essentially permanent fixture, the appliance or apparatus is not to be deemed to constitute goods or burden of any description; and
- (b) water, fuel or accumulators used for the purpose of the supply of power for the propulsion of a vehicle or, as the case may be, of any vehicle by which a trailer is drawn, and loose tools and loose equipment are not to be deemed to constitute goods or burden of any description.

## PART II

### THE TRAFFIC SIGNS GENERAL DIRECTIONS 1994

#### **Citation and commencement**

1. This Part of this Instrument—

- (a) may be cited—
  - (i) as the Traffic Signs General Directions 1994, and
  - (ii) together with Part I above, as the Traffic Signs Regulations and General Directions 1994; and
- (b) shall come into force on 12th August 1994.

#### **Revocations**

2. The Instruments specified in Appendix 2 to this Instrument, so far as they consist of or comprise directions, are hereby revoked except that for the purposes of the Traffic Signs (Welsh and English Language Provisions) Regulations and General Directions 1985(26) the revocations of the Directions marked with an asterisk in Appendix 2 shall have no effect.

#### **Interpretation**

3.—(1) In these Directions—

---

(26) S.I. 1985/713.

*Status: This is the original version (as it was originally made). This item of legislation is currently only available in its original format.*

“the 1971 Regulations” means the “Zebra” Pedestrian Crossings Regulations 1971(27);  
“controlled parking zone” has the meaning given in direction 23;  
“former Directions” means the Directions revoked by these Directions;  
“the Regulations” means the Traffic Signs Regulations 1994(28),  
and the expressions listed in paragraph (2) have the same meaning as in the Regulations.

(2) Those expressions are—

“the 1981 Regulations”;  
“the 1984 Act”;  
“automatic level crossing”;  
“central reservation”;  
“cycle lane”;  
“dual carriageway road”;  
“hours of darkness”;  
“level crossing”;  
“manually operated”;  
“maximum gross weight”;  
“motorway”;  
“national speed limit”;  
“non-primary route”;  
“pedal cycle”;  
“pedestrian zone”;  
“plate”;  
“primary route”;  
“principal road”;  
“road marking”;  
“route”;  
“sign”;  
“speed limit”;  
“stud”;  
“temporary statutory provision”;  
“traffic lane”; and  
“variable message sign”.

#### **References in the Directions**

4. In these Directions, unless it is expressly provided otherwise or the context otherwise requires,

(a) a reference to a numbered direction is a reference to the direction so numbered in these Directions;

---

(27) S.I. 1971/1524.

(28) Part I of this Instrument.

*Status: This is the original version (as it was originally made). This item of legislation is currently only available in its original format.*

- (b) a reference to a numbered paragraph is a reference to the paragraph so numbered in the direction in which the reference occurs;
- (c) a reference to a sub-paragraph followed by a number or letter is a reference to the sub-paragraph bearing that number or letter in the direction in which the reference occurs;
- (d) a reference to a numbered diagram is a reference to the diagram so numbered in a Schedule to the Regulations;
- (e) a reference to a sign shown in a diagram in a Schedule to the Regulations includes a reference to that sign as varied in accordance with the Regulations;
- (f) a reference to a numbered regulation or Schedule is a reference to the regulation of, or to the Schedule to, the Regulations so numbered; and
- (g) in any direction which includes a table, references to a table are to the table in that direction.

### **Saving**

5. Any sign, which immediately before the coming into force of these Directions was placed on or near any road in conformity with the former Directions, so long as it continues to conform with those Directions as though they had not been revoked, shall be treated as if placed in conformity with these Directions, notwithstanding any provision of these Directions to the contrary.

### **Signs to be placed only at sites approved by the Secretary of State**

6. A sign shown in diagram 601.1, or in diagram 1040 or 1040.2 (when either is varied to include a continuous white line bounding the hatched marking), shall not be placed for the first time at any site except with the approval of the Secretary of State.

### **Signs to be placed only to indicate the effect of a statutory prohibition**

7.—(1) Except as provided by paragraph (3), the signs to which this paragraph applies may be placed on or near a road only to indicate the effect of an Act, order, regulation, byelaw or notice (“the effect of a statutory provision”) which prohibits or restricts the use of the road by traffic.

(2) Paragraph (1) applies to—

- (a) the signs shown in diagrams 606, 607, 609, 612, 613, 614, 616, 617, 618, 618.1, 618.2, 618.3, 618.3A, 618.4, 619, 619.1, 619.2, 620, 620.1, 622.1A, 622.2, 622.4, 622.5, 622.6, 625.1, 626.2, 627.1, 629, 629.1, 629.2, 629.2A, 632, 636, 636.1, 637, 637.1, 637.2, 637.3, 638, 638.1, 639, 639.1A, 640, 640.2A, 640.3, 640.4, 640.5, 642, 642.2, 642.3, 643, 644, 646, 647, 650.1, 650.2, 651, 652, 660, 660.3, 660.4, 660.5, 661, 661.1, 661.2, 661.3, 661.4, 662, 663, 663.1, 664, 665, 666, 667, 667.1, 667.2, 668, 668.1, 668.2, 669, 669.1, 670, 671, 672, 673, 674, 675, 804.1, 804.2, 804.3, 810, 951, 952, 953, 953.1, 953.2, 954, 954.1, 954.2, 954.3, 954.4, 955, 956, 957, 958, 958.1, 959, 959.1, 960, 960.1, 961, 962, 962.1, 962.2, 963, 963.1, 963.2, 963.3, 964, 969, 974, 975, 1017, 1018.1, 1019, 1020.1, 1025.1, 1025.3, 1028.2, 1028.3, 1028.4, 1032, 1033, 1036.1, 1036.2, 1037.1, 1046, 1048, 1048.1, 1049, 1049.1, 1050, 2003, 2007, 2009, 2010, 2107, 2108, 2123, 2124, 5001.1, 5001.2, 5003, 5003.1, 5005, 5005.1, 7201, 7203.1, 7204, 7207, 7210, 7211, 7212, 7213, 7214, 7215, 7216, 7217, 7218, 7220, 7230, 7231, 7232, 7233, 7234, 7260, 7261, 7262, 7263, 7282, 7283 and 7284; and
- (b) any sign which, by virtue of regulation 17 and item 31 of Schedule 16, incorporates as a symbol a sign shown in a diagram specified in sub-paragraph (a).

(3) The sign shown in a diagram whose number is specified in an item in column (2) of the Table may be placed at the place or in the circumstances specified in column (3) of that item notwithstanding that it does not in those circumstances indicate the effect of a statutory provision.

**Status:** This is the original version (as it was originally made). This item of legislation is currently only available in its original format.

**Table**

(1) <i>Item</i>	(2) <i>Diagram</i>	(3) <i>Circumstances</i>
1.	606	On the central island of a roundabout or in combination with a plate of the type shown in diagram 608.
2.	609	On a road approaching its junction with a dual carriageway road or in combination with a plate of the type shown in diagram 608.
3.	616, 1046	At a site which has been approved by the Secretary of State.
4.	629.2, 629.2A	On— (a) a road which passes under or through a bridge, tunnel or other structure which limits the height of vehicles using that road; or (b) any such bridge, tunnel or other structure.
5.	2003, 2007, 2009, 2107, 2108	When including a symbol represented in— (a) any diagram in Schedule 1; or (b) diagram 629.2 or 629.2A in the circumstances specified in item 4 above.
6.	669, 669.1	When placed to indicate that the prohibition indicated by the sign shown in diagram 629.2 or 629.2A is ahead, provided that that sign has been placed in the circumstances specified in item 4 above.

(4) The sign shown in diagram 626.2 may be placed only to indicate the effect of a statutory provision which restricts the use of a road carried by a bridge or other structure—

- (a) in the case of vehicles required to be marked with their maximum gross weight, to any vehicle with a maximum gross weight not exceeding that indicated on the sign; or
- (b) in the case of vehicles not required to be marked with their maximum gross weight but required to be marked with their unladen weight, to any vehicle with an unladen weight not exceeding the maximum gross weight indicated on the sign.

### **The placing of certain signs to indicate the beginning of a restriction, requirement, prohibition or speed limit**

8.—(1) This direction applies to a sign which is shown in diagram 616, 617, 618, 618.1, 618.2, 618.3, 618.3A, 619, 619.1, 619.2, 620, 620.1, 622.1A, 622.4, 622.5, 622.6, 625.1, 626.2, 627.1, 629, 629.1, 629.2, 629.2A, 632, 642, 646, 663, 663.1, 665, 667, 667.1, 668, 668.1, 670, 672, 674, 951, 952, 953, 953.1, 955, 956 or 957 and which is placed to indicate the point at which a restriction, requirement, prohibition or speed limit applying to traffic on a road (in this direction called “the relevant road”) begins.

(2) Subject to paragraphs (3) and (4), a sign to which this direction applies shall be placed on the relevant road at or as near as practicable to the point referred to in paragraph (1)—

- (a) where the road has only one carriageway, on each side of the carriageway of the road; or
- (b) where the road has more than one carriageway, on each side of each carriageway in relation to which the restriction, requirement, prohibition or speed limit begins.

(3) Where the relevant road has one carriageway, signs to which this direction applies need only be placed on one side of the relevant road to indicate the point at which a restriction, requirement, prohibition (but not a speed limit) begins—

- (a) where the restriction, requirement or prohibition applies only to traffic on one side of the relevant road; or
- (b) at a junction where—
  - (i) traffic proceeding on another road on which it is permitted to proceed only in one direction turns into the relevant road; or
  - (ii) the relevant road is less than 5 metres wide.

(4) Where a length of road which passes under or through a bridge, tunnel or other structure is subject to a prohibition on vehicles exceeding a particular height, the sign shown in diagram 629.2 or 629.2A may be placed on the bridge, tunnel or other structure to indicate the prohibition in addition to or instead of the signs placed as required by paragraph (2).

### **The placing of certain signs to indicate the end of a restriction, requirement, prohibition or speed limit**

9.—(1) When a sign shown in diagram 618.4, 622.2, 645, 647, 664, 666, 667.2, 668.2, 673, 675 or 964 is placed to indicate the point at which traffic on a road ceases to be subject to a restriction, requirement, prohibition or speed limit, the sign shall be placed on the road as near as practicable to that point.

(2) Where a length of road ceases to be subject to a speed limit and becomes subject to a national speed limit, the sign shown in diagram 671 shall be placed at or as near as practicable to the point where the speed limit ends and a national speed limit begins, except in a case where a restriction of speed has been imposed under section 14 of the 1984 Act by reason of works which are being or are proposed to be executed on or near the road in which case

- (a) the sign shown—
  - (i) in diagram 7006; or
  - (ii) in diagram 7001 when placed in combination with the plate shown in diagram 645; shall be placed as indicated above in this paragraph; and
- (b) the sign shown in diagram 671 may also be so placed.

(3) When a sign shown in diagram 671, 673 or 675 is placed to indicate the point at which traffic on a road ceases to be subject to a speed limit—

*Status: This is the original version (as it was originally made). This item of legislation is currently only available in its original format.*

- (a) where the road has only one carriageway, one such sign shall be placed on each side of the carriageway of the road; or
- (b) where the road has more than one carriageway, one such sign shall be placed on each side of each carriageway on which the speed limit ends.

### **Repeater signs**

**10.**—(1) Paragraph (2) applies to the signs shown in diagrams 614, 632, 636, 636.1, 637, 637.1, 637.2, 637.3, 638, 638.1 when the arrow is omitted, 639 when the arrow is omitted, 640 when the arrow is omitted, 642, 646, 670, 672, 956, 957, 959, 959.1, 960, 960.1 and 961.

(2) Signs to which this paragraph applies shall be placed at regular intervals along a road which is subject to a restriction, requirement, prohibition or speed limit which can be indicated by the signs, except that the sign shown in diagram 670 shall not be placed along a road which is—

- (a) in England and Wales a restricted road as defined by section 82 of the 1984 Act and in Scotland a road as respects which there is in force an order prohibiting the driving of motor vehicles at a speed exceeding 30 miles per hour and on which there is provided a system of carriageway lighting furnished by means of lamps placed not more than 185 metres apart; or
- (b) a motorway on which a national speed limit is in force.

(3) The sign shown in diagram 671 shall be placed at regular intervals along the length of a road (other than a motorway) on which—

- (a) there is a system of street or carriageway lighting furnished by lamps lit by electricity placed not more than 183 metres apart in England and Wales or not more than 185 metres apart in Scotland; and
- (b) a national speed limit is in force.

### **Signs to be placed only on specified types of road**

**11.**—(1) The signs shown in diagrams 2001, 2002, 2003, 2004, 2005, 2006, 2007, 2008, 2009, 2010, 2011, 2012, 2013, 2014, 2015, 2016, 2017, 2018, 2019, 2020, 2021, 2022, 2023, 2024, 2025, 2030, 2030.1, 2032, 2033, 2034, 2313, 2314, 2315 and 2315.1 may be placed only on or near a primary route.

(2) The signs shown in diagrams 2026, 2027, 2028 and 2029 may be placed only on a primary route, or on a non-primary route at a junction with a primary route.

**12.**—(1) The signs shown in diagrams 2101, 2101.1, 2101.2, 2102, 2103, 2104, 2105, 2106, 2107, 2108, 2109, 2110, 2111, 2112, 2113, 2113.1, 2114, 2115, 2115.1, 2116, 2117, 2118, 2119, 2120, 2121, 2122, 2123, 2124, 2128, 2130, 2131, 2133, 2135, 2138, 2310, 2311, 2312 and 2312.1 may be placed only on or near a non-primary route.

(2) The signs shown in diagrams 2125, 2126, 2127, 2132, 2134, 2136, 2137, 2322, 2323 and 2807 may be placed only on or near a non-primary route, or on a primary route at a junction with a non-primary route.

(3) The signs shown in diagrams 1012.3, 2031, 2129, 2201, 2202, 2203, 2204, 2205, 2206, 2207, 2208, 2209, 2210, 2211, 2212, 2213, 2214, 2215, 2216, 2301, 2302, 2303, 2304, 2305, 2306, 2307, 2308, 2309, 2316, 2317, 2318, 2319, 2320, 2321, 2401, 2402, 2403, 2501, 2502, 2503, 2504, 2505, 2506, 2507, 2508, 2509, 2601, 2602, 2603, 2604, 2605, 2606, 2607, 2608, 2609, 2610, 2610.1, 2610.2, 2701, 2702, 2703, 2704, 2705, 2706, 2707, 2708, 2709, 2710, 2712, 2713.1, 2801, 2802, 2803, 2804, 2805, 2806 and 7240 may not be placed on a motorway.

**Status:** This is the original version (as it was originally made). This item of legislation is currently only available in its original format.

**13.**—(1) The signs shown in diagrams 832.3, 1012.2, 1042, 2901, 2903, 2904, 2904.1, 2905, 2906, 2908, 2909, 2910, 2910.1, 2911, 2912, 2913, 2914, 2915, 2916, 2917, 2918, 2919, 2920, 2922, 2923, 2924, 2925, 2926, 2927, 2928, 2929, 2930, 2931, 2932, 7002, 7212, 7220, 7230 and 7233 may be placed only on or near a motorway.

(2) The signs shown in diagrams 2902 and 2902.1 may be placed only on a motorway or on another road at a junction with a motorway.

**14.**—(1) The signs shown in diagrams 823, 824, 825, 868, 868.1, 872, 873, 874, 875 and 876 may be placed only on or near—

- (a) a motorway when the colour of the background of the sign is blue;
- (b) a primary route when the colour of the background of the sign is green; or
- (c) a non-primary route when the colour of the background of the sign is white.

(2) The sign shown in diagram 877 may be placed only on or near—

- (a) a primary route when the colour of the background of the sign is green; or
- (b) a non-primary route when the colour of the background of the sign is white.

**Signs to be placed only in conjunction with specified road markings (except signs for prohibitions and restrictions on waiting etc)**

**15.**—(1) Save as provided in paragraph (2), a sign shown in a diagram whose number appears and is placed in the circumstances (if any) or is in the form (if any) specified in an item in column (2) in the Table may be placed on a road only in conjunction with a road marking shown in a diagram whose number appears and is in the form (if any) specified in column (3) of that item.

**Table**

(1) <i>Item</i>	(2) <i>Sign diagram number</i>	(3) <i>Road marking diagram number</i>
1.	557.1	1060, 1060.1, 1061 or 1061.1
2.	601.1	1002.1 and 1022
3.	602	1003 and 1023
4.	611.1 if placed in conjunction with diagram 602	1003, 1003.4 and 1023
5.	611.1	1003.3 and 1003.4
6.	957	1057
7.	959	1048 and 1049
8.	959.1	1049 varied to a width of 150 millimetres and 1057
9.	960	1048 and 1049
10.	960 varied to include pedal cycle symbol	1048.1 and 1049
11.	960.1	1049 varied to a width of 150 millimetres and 1057

*Status: This is the original version (as it was originally made). This item of legislation is currently only available in its original format.*

(2) The provisions of paragraph (1) requiring the placing of a sign shown in diagram 601.1, 602 or 611.1 in conjunction with a road marking shall not apply during the execution of works on a road near the sign—

- (a) if those works necessitate the temporary removal of the marking; or
- (b) if the sign is erected only temporarily in connection with the execution of works on a road.

**Road markings to be placed only in conjunction with other road markings or specified signs (except road markings for prohibitions and restrictions on waiting etc)**

16.—(1) A road marking shown in a diagram whose number appears and is placed in the circumstances (if any) specified in an item in column (2) of the Table may be placed on the carriageway of a road only in conjunction with a road marking or sign shown in a diagram whose number appears and is in the form (if any) specified in column (3) of that item.

**Table**

(1) <i>Item</i>	(2) <i>Road marking diagram number</i>	(3) <i>Road marking or sign number</i>
1.	1001 unless placed at a site where traffic is from time to time controlled by a constable	3000, 3000.1, 3000.2, 3000.3, 3000.4, 3000.5, 3000.6 or 3014
2.	1002.1 and 1022	601.1
3.	1003.3	611.1 and 1003.4
4.	1003.4	611.1
5.	1022	601.1 and 1002.1
6.	1023	1003
7.	1024.1	1010 and 1014
8.	1048	1049 and either 959 or 960
9.	1048.1	1049 and 960 varied to include the pedal cycle symbol
10.	1049	957 and 1057, or 1048 and either 959 or 960, or 1048.1 and 960 varied to include the pedal cycle symbol, or 1057 and either 959.1 or 960.1
11.	1049.1	957 and 1057
12.	1050	964 and 1049
13.	1057	955, 956, 957, 959.1, 960.1 or 967
14.	1058	1057
15.	1059	1057
16.	1060, 1060.1, 1061, 1061.1 unless 557.1 placed in a zone	



**Status:** This is the original version (as it was originally made). This item of legislation is currently only available in its original format.

(1) <i>Item</i>	(2) <i>Road marking diagram number</i>	(3) <i>Road marking or sign number</i>
	indicated by the sign shown in diagram 674	

(2) A road marking shown in diagram 1003, 1023 or 1049 when varied in size to conform with any of the smaller dimensions prescribed for it may be placed on the carriageway only in conjunction with the marking shown in diagram 1057 and with one or more of the signs shown in diagrams 955, 957, 959.1, 960.1 and 967.

(3) The road marking shown in diagram 1009 when varied in size to conform with the smallest dimensions prescribed for it may be placed on the carriageway only to mark the junction of a cycle track and another road and in conjunction with the road markings shown in diagrams 1003 and 1023 and having the smaller dimensions prescribed for them.

### The placing of the signs shown in diagrams 615 and 811

17. The signs shown in diagrams 615 and 811 may be placed on a road only in conjunction with one another.

### Signs to be placed only in combination with specified plates or other signs

18.—(1) A sign shown in a diagram whose number appears and is placed in the circumstances (if any) specified in an item in column (2) of the Table may be placed on a road only in combination with a plate shown in the diagram whose number appears in column (3) of that item.

**Table**

(1) <i>Item</i>	(2) <i>Sign diagram number</i>	(3) <i>Plate diagram number</i>
1.	501 when placed in advance of the sign shown in diagram 601.1	502
2.	501 when placed in advance of the sign shown in diagram 602	503
3.	544.2	547.4
4.	553.1	553.2
5.	554.2	554.3
6.	556.1	556.2
7.	557.1	557.2, 557.3 or 557.4
8.	562	563, 563.1 or 7022
9.	583	583.1
10.	615	615.1
11.	617	618 or 618.1
12.	779	780, 780.1 or 780.2
13.	811	811.1

**Status:** This is the original version (as it was originally made). This item of legislation is currently only available in its original format.

(1) <i>Item</i>	(2) <i>Sign diagram number</i>	(3) <i>Plate diagram number</i>
14.	953	953.2
15.	953.1	953.2

(2) The sign shown in diagram 545 may be placed on a road only in combination with a plate shown in diagram 546, 547.1, 547.2, 547.3 or 547.7 or the sign shown in diagram 4004.

(3) A sign shown in diagram 515.1A or 515.2 may be placed on a road only in combination with the sign shown in diagram 606.

### Plates to be placed only in combination with specified signs

**19.** A plate shown in a diagram whose number appears and is in the form (if any) specified in an item in column (2) of the Table may be placed on a road only in combination with a sign shown in a diagram whose number appears and is placed in the circumstances (if any) specified in column (3) of that item.

**Table**

(1) <i>Item</i>	(2) <i>Plate diagram number</i>	(3) <i>Sign diagram number</i>
1.	502	501
2.	503	501
3.	511	504.1, 505.1, 506.1, 507.1, 510, 512, 512.1, 512.2, 513, 516, 517, 520, 523.1, 524.1, 528 or 556
4.	511 when varied to "HEAVY PLANT CROSSING"	504.1, 505.1, 506.1, 507.1, 512.1 or 512.2
5.	513.1	512, 512.1, 512.2 or 513
6.	513.2	512, 512.1, 512.2, 513 or 7009
7.	518	516, 517 or 520
8.	519	516 or 517
9.	525	523.1 or 524.1
10.	526	512, 512.1, 512.2, 513, 523.1, 524.1 or 554.1
11.	527	523.1 or 524.1
12.	530.1	530
13.	530.2	530, 629.2 or 629.2A
14.	531.2	531.1
15.	543.1	543, 3000, 3000.3, 3000.4, 3000.5 or 3000.6
16.	546	545

**Status:** This is the original version (as it was originally made). This item of legislation is currently only available in its original format.

(1) <i>Item</i>	(2) <i>Plate diagram number</i>	(3) <i>Sign diagram number</i>
17.	547.1	545
18.	547.2	545
19.	547.3	544.1 or 545
20.	547.4	544.2
21.	547.5	544
22.	547.6	543
23.	547.7	545
24.	548.1	548 when placed in advance of the sign shown in diagram 4005
25.	553	552
26.	553.2	553.1
27.	554.3	554.2, 622.1A, 622.4, 629, 629.1 or 632
28.	556.2	556.1
29.	557.2	557.1
30.	557.3	557.1
31.	557.4	557.1
32.	558.2	558
33.	563	562
34.	563.1	562
35.	570	513, 516 when placed in combination with 518 or 519, 517 when placed in combination with 518 or 519, 521, 523.1, 524.1, 548, 549, 550, 550.1, 51, 551.1, 551.2, 553.1, 554.2, 556, 556.1, 557, 558, 558.1, 559, 581, 582, 614, 615, 632, 642, 811, 7001 or 7009
36.	572	504.1, 505.1, 506.1, 507.1, 516, 517, 520, 521, 522, 523.1, 524.1, 528, 529, 529.1, 530, 531.1, 543, 544, 544.1, 544.2, 545, 552, 554, 555, 562, 770, 771, 772, 782, 950, 7001 or 7009
37.	573	516, 517, 523.1, 524.1, 528, 529, 529.1, 530, 531.1, 543,

**Status:** This is the original version (as it was originally made). This item of legislation is currently only available in its original format.

(1) <i>Item</i>	(2) <i>Plate diagram number</i>	(3) <i>Sign diagram number</i>
		544, 544.1, 544.2, 545, 552, 554, 555, 562, 770, 771, 772, 782, 950, 7001 or 7009
38.	575	516, 517, 528 or 529.1
39.	583.1	583
40.	607	606 or 609
41.	608	501, 601.1, 602, 606, 609 or 610
42.	615.1	615
43.	618	617
44.	618.1	617
45.	620	619, 619.1, 619.2, 622.1A, 622.5, 622.6, 629, 629.1 or 952
46.	620.1	619 or 619.1
47.	627.1	626.2
48.	643	636 or 642
49.	644	636 or 642
50.	645	614, 615, 632, 642, 811 or 7001
51.	773	529, 529.1, 558, 770, 771 or 772
52.	778	602
53.	778.1	602
54.	780	779
55.	780.1	779
56.	780.2	779
57.	804.1	801
58.	804.2	801
59.	804.3	801
60.	811.1	811
61.	817.2	523.1 and either 523 or 526, or 554.1 and 526
62.	876	868, 868.1, 872, 873, 874 or 875
63.	950.1	950
64.	953.2	953 or 953.1

**Status:** This is the original version (as it was originally made). This item of legislation is currently only available in its original format.

(1) <i>Item</i>	(2) <i>Plate diagram number</i>	(3) <i>Sign diagram number</i>
65.	954	606, 609, 612, 613, 616, 629 or 629.1
66.	954.1	606, 609, 612, 613, 616, 629 or 629.1
67.	954.2	606, 609, 612, 613, 616, 629, 629.1 or 952
68.	954.3	606, 609, 612 or 613
69.	954.4	606, 609, 612, 613 or 816
70.	961	958, 958.1, 959 or 959.1
71.	7001.1	7001
72.	7001.2	7001
73.	7021	7001
74.	7022	562
75.	7208	7202, 7206 or 7207
76.	7209	7203, 7203.1, 7204 or 7205
77.	7256	7250, 7251, 7252, 7253, 7254 or 7255
78.	7401.1	7401

(2) A plate shown in diagram 954.3 or 954.4 shall not be placed in combination with the sign shown in diagram 616.

### **Placing of road markings and signs to indicate prohibitions and restrictions on waiting, loading and unloading and parking**

**20.**—(1) Subject to paragraphs (2) and (3)—

- (a) the road marking shown in diagram 1018.1 may be placed on a side of a road only for the purpose of indicating a statutory prohibition or restriction on the waiting of vehicles which applies on that side of the road at all times of day on every day of the year or on every day in a period of at least four consecutive months;
- (b) the road marking shown in diagram 1017 may be placed on a side of a road only for the purpose of indicating a statutory prohibition or restriction on the waiting of vehicles which is not a restriction of the kind mentioned in sub-paragraph (a).

(2) In this direction, references to a statutory prohibition or restriction on the waiting of a vehicle do not include references to any such prohibition or restriction imposed—

- (a) on waiting for the purpose of loading or unloading goods from a vehicle or picking up or setting down passengers from a vehicle;
- (b) expressly to limit the duration of waiting of vehicles within a particular period; or
- (c) on the waiting of goods vehicles (as defined by section 192(1) of the Road Traffic Act 1988(29)) but of no other class of vehicle.

(29) 1988 c. 52.

*Status: This is the original version (as it was originally made). This item of legislation is currently only available in its original format.*

(3) A road marking shown in diagram 1017 or 1018.1 shall not be placed on a road on which a marking shown in diagram 1025.1 or 1025.3 is placed, or on which the marking shown in diagram 1027.1 is placed in conjunction with the sign shown in diagram 642.2 unless the restrictions indicated by the marking shown in diagram 1017 or 1018.1 apply on that road at times other than those indicated on the sign shown in diagram 642.2.

**21.**—(1) The road marking shown in diagram 1020.1 may be placed on a side of the carriageway of a road only for the purpose of indicating a statutory prohibition or restriction on the waiting of vehicles for the purpose of their being loaded or unloaded which applies on that side of the road at all times of the day on every day of the year or on every day in a period of at least four consecutive months.

(2) The road marking shown in diagram 1019 may be placed on a side of the carriageway of a road only for the purpose of indicating a statutory prohibition or restriction on the waiting of vehicles for the purpose of their being loaded or unloaded (but not for indicating a statutory prohibition or restriction which expressly limits the duration of waiting by vehicles within a particular period for that purpose) which is not a restriction of the kind mentioned in paragraph (1).

**22.**—(1) Except where it is placed to indicate the effect of a temporary statutory provision, a sign shown in a diagram whose number appears in column (2) of an item in the Table shall not be placed except—

- (a) on or near the side of a road, and
- (b) in conjunction with, and on the same side of the road as, a road marking which is shown in a diagram and is in the form (if any) indicated in column (3) of that item.

**Table**

(1) <i>Item</i>	(2) <i>Sign diagram number</i>	(3) <i>Road marking diagram</i>
1.	637	1018.1
2.	637.3	1018.1
3.	638	1020.1
4.	638.1	1019
5.	639	1017
6.	639.1A	1017 and 1028.4 (when no legend appears) or 1033
7.	640	1017 and 1019
8.	642.2	1027.1
9.	642.3	1018.1 and 1020.1
10.	650.1	1028.2 when indicating “TAXIS”
11.	650.2	1028.2 when indicating “TAXIS”
12.	660	1028.3 when varied to indicate “LARGE OR SLOW VEHICLES ONLY”, 1028.4 when indicating “DOCTOR”

**Status:** This is the original version (as it was originally made). This item of legislation is currently only available in its original format.

(1) <i>Item</i>	(2) <i>Sign diagram number</i>	(3) <i>Road marking diagram</i>
		or when no legend appears, or 1033
13.	660.3	1028.4 when indicating “DOCTOR” or when no legend appears, or 1033
14.	660.4	1028.3 when varied to indicate “LOADING ONLY”, or 1033
15.	660.5	1028.4 when no legend appears, 1032 or 1033
16.	661	1028.3 or 1033 when either road marking is indicating “DISABLED” or when no legend appears
17.	661.1	1028.4 when no legend appears, 1032 or 1033
18.	661.2	1028.4 when no legend appears, 1032 or 1033
19.	662	1028.4 when no legend appears, 1032 or 1033
20.	974	1025.1 or 1025.3
21.	975	1025.1 or 1025.3 when either marking is varied to “BUS STAND”

(2) Subject to paragraph (3) the sign shown in diagram 637.2 may be placed only on a road within a pedestrian zone where a sign shown in diagram 618.2, 618.3 or 618.3A is placed at each entrance into the zone for vehicular traffic.

(3) The sign shown in diagram 637.2 shall not be used on a road within the pedestrian zone to which the sign relates except in conjunction with—

- (a) the road marking shown in diagram 1017 or 1018.1 unless—
  - (i) the road does not comprise a carriageway and footway which are separately defined;
  - (ii) the entry of vehicular traffic into the pedestrian zone is restricted at the same times as those at which the waiting of vehicles is prohibited as indicated on the upper panel of the sign in diagram 637.2; and
  - (iii) the prohibition on the waiting of vehicles applies uniformly throughout every road in the zone, and
- (b) where there is a prohibition on the loading and unloading of vehicles, the road marking shown in diagram 1019 or 1020.1 unless—
  - (i) the road does not comprise a carriageway and footway which are separately defined;
  - (ii) the entry of vehicular traffic into the pedestrian zone is restricted at the same times as those at which the loading and unloading of vehicles is prohibited as indicated on the lower panel of the sign in diagram 637.2; and

**Status:** This is the original version (as it was originally made). This item of legislation is currently only available in its original format.

(iii) the prohibition on the loading and unloading of vehicles applies uniformly throughout every road in the zone.

**23.—**(1) Subject to paragraph (2) a road marking shown in a diagram whose number appears and is in the form (if any) specified in an item in column (2) of the Table may be placed on the carriageway only in conjunction with, and on the same side of the road as, a sign shown in a diagram whose number appears and is in the form specified (if any) in column (3) of that item.

**Table**

(1) <i>Item</i>	(2) <i>Road marking diagram number</i>	(3) <i>Sign diagram number</i>
1.	1017	637.2, 639, 639.1A or 640
2.	1018.1	637, 637.2, 637.3 or 642.3
3.	1019	637.2, 638.1 or 640
4.	1020.1	637.2, 638 or 642.3
5.	1025.1	974 or 975
6.	1025.3	974 or 975
7.	1028.2 when indicating “TAXIS”	650.1 or 650.2
8.	1028.2 when varied to “BUSES” or “COACHES”	969
9.	1028.3 when indicating “DISABLED” or when no legend appears	661
10.	1028.3 when varied to “LARGE OR varied to” Large or slow “SLOW VEHICLES ONLY vehicles only”	660
11.	1028.3 when varied to “LOADING ONLY”	660.4
12.	1028.4 when indicating “DOCTOR” varied to “Doctor permit holders only”	660
13.	1028.4 when no legend appears	639.1A, 660, 660.3, 660.5, 661.1, 661.2, 661.3, 662 or 801
14.	1033 when indicating “DISABLED”	661

(2) Paragraph (1) shall not apply to a road marking placed on a road within a controlled parking zone, except where the road marking is placed to indicate restrictions different from the restrictions indicated on a sign shown in diagram 663 or 663.1 placed at the entrances for vehicular traffic into the zone.

(3) In this direction and direction 24, “controlled parking zone” means either—



- (a) an area—
  - (i) in which, except where parking places have been provided, every road has been marked with one or more of the road markings shown in diagrams 1017, 1018.1, 1019 and 1020.1; and
  - (ii) into which each entrance for vehicular traffic has been indicated by a sign shown in diagram 663 or 663.1; or
- (b) an area—
  - (i) in which at least one of the signs shown in diagram 640.2A has been placed on each side of every road; and
  - (ii) into which each entrance for vehicular traffic has been indicated by a sign shown in diagram 665.

**24.** A sign shown in diagram 663, 663.1, 664 , 665 or 666 may be placed only at the boundary of a controlled parking zone.

#### **Signs to be placed only at specified sites or for specified purposes**

**25.** The sign shown in diagram 545, when placed in combination with the plate shown in diagram 547.1, or with a plate shown in either diagram 546 or 547.1 together with the sign shown in diagram 4004, may be placed only near a school crossing place as defined by regulation 39(2).

**26.** The sign shown in diagram 551.1 may be placed on or near a road only—

- (a) at a site which is approved as a migratory toad crossing by or on behalf of the Secretary of State; and
- (b) during February, March, April and May in each year.

**27.** The sign shown in diagram 574 may be placed only in or near an infected place or area for the purposes of the Animal Health Act 1981(30) and shall be removed as soon as it ceases to be in or near such a place or area.

**28.** A sign shown in diagram 830, 830.1, 831 or 832, except when varied to contain the words “WEIGHT CHECK”, and the sign shown in diagram 830.3 except when placed in connection with a weight check, may be placed only in connection with a traffic census the taking of which on a road has been approved—

- (a) by the traffic authority for that road;
- (b) by the chief officer of police of the police area in which the road is situated; and
- (c) by or on behalf of the Secretary of State.

**29.** A sign shown in diagram 833, 834, 835 or 836 may be placed only to regulate the movement of vehicular traffic into and out of premises with more than one access to a road.

**30.** The sign shown in diagram 957 may be placed on a road only when the road has been divided into a part reserved for the use of pedal cycles only and a part reserved for use by pedestrians only by either or both of the following means—

- (a) the road marking shown in diagram 1049 (when that marking is varied to be 150 millimetres wide) or 1049.1;
- (b) the presence on the road of works such as distinctive colouring of the surface of each part, a kerb or other device.

*Status: This is the original version (as it was originally made). This item of legislation is currently only available in its original format.*

### **Restrictions on the placing of temporary signs**

**31.** The signs shown in any diagram in Schedule 12 other than diagrams 7014 and 7103 may be placed only in connection with the execution of works on or near a road or a temporary obstruction thereon, and any such sign so placed and any other sign shown in a diagram in Schedules 1 to 11 so placed shall not be retained on or near the road after the completion of the works or the removal of the obstruction, as the case may be, unless—

- (a) it is a sign of the type shown in diagram 7009, in which case that sign may be retained on or near a road after the completion of the works for so long as the traffic authority for the road thinks fit; or
- (b) it is a sign of the type shown in diagram 7012 bearing the words “NO GIVE WAY MARKINGS” or “NO STOP MARKINGS”, in which case that sign shall be removed as soon as the road markings have been replaced and in any event not later than 28 days after the completion of the works.

**32.** A sign shown in diagram 790 or 7014 may be placed on or near a road only in connection with works involving an alteration in the layout of the carriageway or involving the removal of or a change in the road markings or other traffic signs placed on or near a road or, in the case of the sign shown in diagram 790, at an automatic railway level crossing, and may be retained for not more than 3 months after completion of those works.

**33.—(1)** No sign of the kind referred to in regulation 41 may be retained at any place for more than six months (or such longer period as the Secretary of State may approve) after the placing of the sign there or in any event after the sign has ceased to be needed at that place.

(2) The sign shown in diagram 2701 may be retained on or near a road for not more than six months after completion of the housing development to which it refers.

**34.—(1)** A sign shown in diagram 7023 or 7024 may be placed on or near a road only where one-way working is necessary owing to a temporary closure to vehicular traffic of a part of the width of the carriageway of the road.

(2) A sign shown in diagram 829.1, 829.2, 829.3, 829.4 or 1063 may be placed on or near a road only by a constable in uniform or a person acting under the instructions or authority of the chief officer of police.

(3) A sign shown in diagram 554 (when varied to “Flood” or “No smoking”), 554.2 (when placed in conjunction with the plate shown in diagram 554.3), or 562 (when placed in combination with the plate shown in diagram 563 varied to “Accident”, “Census”, “Dust cloud”, “Fallen tree”, “Overhead cable repairs” or “Smoke”) may be retained only on or near a road for so long as the hazard indicated by the sign continues to exist or is expected to recur in the near future.

(4) The sign shown in diagram 950 may be placed in combination with the plate shown in diagram 950.1 only while the training or testing of child cyclists is in progress.

### **Placing of signs varied to show metric units**

**35.—(1)** Where the indication given by a sign shown in diagram 629, 629.1, 780, 780.1 or 780.2 is varied in accordance with regulation 17 and item 2 of Schedule 16, that sign may be placed only in combination with another sign of the same type whose indication has not been so varied.

(2) Paragraph (1) shall apply when a sign shown in diagram 629 or 629.1 is incorporated as a symbol into another sign.

### **Mounting and backing of signs**

**36.**—(1) Where a sign shown in a diagram (other than the diagrams referred to in paragraphs (2) to (4) or direction 38 or 39) in Schedules 1 to 5, 7, Part II of Schedule 10, Schedule 12 or a sign prescribed in regulation 41 is mounted on a post specially provided for the purpose (“the post”), that part of the post which extends above ground level shall be coloured grey or black, except that—

- (a) where the post is made of aluminium, concrete, galvanised metal or wood, the post may retain its natural colour; and
- (b) where the post is not likely to be readily visible to pedestrians if wholly coloured grey or black, a yellow or white band not less than 140 nor more than 160 millimetres deep may be provided on the post, the lower edge of the band being not less than 1500 nor more than 1700 millimetres above ground level.

(2) Where a beacon or lamp of a kind prescribed by regulation 42 or 43 is mounted on a structure specially provided for the purpose, the structure shall be coloured grey, red, white or yellow, or in alternate bands of red and white or of black and white.

(3) The post provided for the mounting of the sign shown in diagram 605.2 shall be coloured in alternate black and yellow bands each 300 millimetres deep with a black band uppermost below the bottom of the sign face, and the yellow bands may be illuminated by means of retroreflecting material.

(4) A post or other support provided for the mounting of a sign shown in diagram 651, 970, 971, 972, 973, 973.1, 2610, 2610.1, 2610.2, 7104 or 7105 may be of any colour.

**37.**—(1) The back of any sign shown in a diagram in Schedules 1 to 5, 7, Part II of Schedule 10 or in Schedule 12, or prescribed in regulation 41, other than a sign shown in diagram 651, 970, 971, 972, 973, 973.1, 2610, 2610.1, 2610.2, 7101, 7102, 7103, 7104 or 7105, and the back of any backing board or other fitting provided for the assembly of such a sign including any container enclosing apparatus for the illumination of that sign, shall be coloured—

- (a) black if the sign is mounted on the same post as that on which light signals prescribed in regulation 30(2) (or those signals as varied by regulation 31) or light signals prescribed in regulation 30(3) and regulation 32 are mounted; or
- (b) grey, black or in a non-reflective metallic finish in any other case, except that—
  - (i) information about sites for placing and the ownership of the sign may be indicated on the back of the sign in characters not exceeding 15 millimetres in height; and
  - (ii) information about the manufacture of the sign required in order to comply with British Standard Specification BS 873 or an equivalent specification of a European Economic Area State, occupying an area not exceeding 30 square centimetres, may be indicated on the back of the sign in characters not exceeding 5 millimetres in height.

(2) The back of a sign shown in diagram 7104 or 7105 shall be coloured grey, red, white, black or yellow, except that—

- (a) information about sites for placing and the ownership of the sign may be indicated on the back of the sign in characters not exceeding 15 millimetres in height; and
- (b) information about the manufacture of the sign required in order to comply with British Standard Specification BS 873 or an equivalent specification of a European Economic Area State, occupying an area not exceeding 30 square centimetres, may be indicated on the back of the sign in characters not exceeding 5 millimetres in height.

(3) The back of a sign shown in diagram 651, 970, 971, 972, 973, 973.1, 2610, 2610.1 or 2610.2 may be of any colour.

*Status: This is the original version (as it was originally made). This item of legislation is currently only available in its original format.*

(4) The front of any backing board for a sign mounted otherwise than as described in paragraph (1) (a) shall be coloured either grey or yellow.

(5) Any sign shown in a diagram in Schedules 1 to 5, 7, Part II of Schedule 10, or Schedule 12 which has a red or black border may have a white edge added not less than 10 nor more than 20 millimetres wide, outside that border.

(6) In this direction “backing board” in relation to a sign includes any background against which the sign is displayed.

### **Mounting of the sign shown in diagram 781**

**38.** The sign shown in diagram 781 shall be mounted on two posts and so much of each post as extends above ground level shall be coloured black and white in alternate horizontal bands, each band being not less than 250 nor more than 335 millimetres deep.

### **Mounting of the signs shown in diagrams 560 and 561**

**39.**—(1) A sign shown in diagram 560 or 561 shall be so placed that the top of the sign is not less than 550 nor more than 1000 millimetres above the surface of the adjacent carriageway.

(2) Where a sign shown in diagram 560 or 561 is mounted on a post specially provided for the purpose that part of the post which extends above ground level shall be coloured black and white in alternate horizontal bands, each band being not less than 225 nor more than 350 millimetres deep.

(3) The signs shown in diagrams 560 and 561 shall be so erected as to display—

- (a) the colour red on the left hand edge of the carriageway as viewed by the drivers of approaching vehicles; and
- (b) the colour white on the right hand edge of the carriageway when so viewed, unless the edge is the edge of the carriageway of a dual carriageway road when the colour amber shall be displayed.

### **Mounting of refuge indicator lamps**

**40.**—(1) Save as provided in paragraph (2), where the lamp prescribed in regulation 45 is mounted on a post specially provided for the purpose—

(a) if the post is placed on a street refuge or central reservation of a zebra crossing and yellow globes are attached to or mounted on the post—

(i) the part of the post between ground level and the point where the yellow globes are mounted or attached shall be coloured black and white in alternate horizontal bands, the lowest band visible to approaching traffic being coloured black and not less than 275 millimetres nor more than 1 metre deep, and each other band being not less than 275 nor more than 335 millimetres deep; and

(ii) beyond the point referred to in sub-paragraph (a)(i) any remaining part of the post shall be coloured in accordance with sub-paragraph (b); and

(b) if the post—

(i) is a post placed as mentioned in sub-paragraph (a) but yellow globes are not attached to or mounted on it; or

(ii) is placed elsewhere than on a zebra crossing,

the post shall be coloured grey or black but with two white bands (each band being not less than 275 nor more than 335 millimetres deep) so arranged that—

(i) at least 275 nor more than 335 millimetres extend between the nearest edges of the two bands; and

(ii) the upper edge of the uppermost band is not less than 275 nor more than 335 millimetres below the lowest part of the lamp,

and the white bands may be internally illuminated.

(2) Where a post of the kind mentioned in paragraph (1) consists of aluminium, concrete or galvanised metal it may remain in its natural colour.

(3) In this paragraph “zebra crossing” has the same meaning as in the 1971 Regulations and “yellow globes” means globes in relation to which Part II of Schedule 2 to the 1971 Regulations is complied with.

### **Mounting and backing of light signals, matrix signs and warning lights**

**41.**—(1) Light signals such as are prescribed in regulations 30, 31, 32, 34, 35, 37 and 38, the matrix signals prescribed in regulation 36 and the warning lights prescribed in regulations 39(2) and 40 may be placed on or near a road only if they are so placed that they face the stream of traffic to which they are intended to convey the warnings, information, requirements, restrictions or prohibitions prescribed by the Regulations.

(2) The containers enclosing the lamps of each of the types of light signals, matrix signs or warning lights mentioned in paragraph (1) shall be coloured black except that, if those containers enclose lamps of the light signals prescribed in paragraph (5) or (7) of regulation 30, or in regulation 34 or 35, the matrix signs prescribed in regulation 36 or the warning lights prescribed in regulation 39(2) and 40, they may be coloured grey instead of black.

(3) Any of the kinds of light signals mentioned in paragraph (1) other than the signals prescribed in regulation 30(7) may be mounted on a backing board, which shall be coloured black and may have a white border not less than 45 nor more than 55 millimetres wide.

(4) In the case of the light signals prescribed in of regulation 30(7) the back of the backing board shown in diagram 3014 may be coloured black or grey.

(5) In the case of the matrix signs prescribed in regulation 36, an identification number may be shown on the front of the backing board below the signal in the manner shown in diagram 6022.

(6) Without prejudice to paragraph (7), where light signals prescribed in any of the regulations specified in paragraph (1) or shown in a diagram in Part I of Schedule 10 or in Schedule 11 are mounted on a post specially provided for the purpose, that part of the post which extends above ground level shall be coloured grey or black and may have one yellow or white band not less than 140 nor more than 160 millimetres deep, the lower edge of the band being not less than 1500 nor more than 1700 millimetres above ground level.

(7) The light signals, matrix signs or warning lights prescribed in regulation 32, instead of being mounted on a post coloured in accordance with paragraph (6), may be mounted on a post coloured yellow (but having no yellow or white band as specified in paragraph (6)) or on a tripod coloured yellow.

### **Placing of road marking shown in diagram 1001 in conjunction with light signals**

**42.**—(1) The light signals prescribed in paragraph (2), (3) or (7) of regulation 30 may be placed only in conjunction with the road marking shown in diagram 1001, except that this paragraph shall not apply while works which necessitate the temporary removal of that road marking are being executed on a road near the light signals.

(2) Where both primary and secondary signals within the meaning of regulation 33(6) have been erected, the references in paragraph (1) to light signals shall be construed as references to—

- (a) both the primary and the secondary signals;
- (b) the primary signals operating alone; or

*Status: This is the original version (as it was originally made). This item of legislation is currently only available in its original format.*

(c) the secondary signals operating alone,  
as the case may be.

**Placing of road marking shown in diagram 1014 in conjunction with the road marking shown in diagram 1013.1 or 1013.3**

**43.**—(1) At least one road marking of the type shown in diagram 1014 shall be placed in conjunction with a road marking of the type shown in diagram 1013.1 or 1013.3 on the length of carriageway which extends backwards from the commencement of any continuous line marked on the carriageway as a part of the road marking shown in diagram 1013.1 or 1013.3, such commencement being viewed in the direction of travel of a vehicle driven so as to have and keep that continuous line on the right hand or off side thereof in accordance with regulation 26(2)(b).

(2) If more than one road marking of the type shown in diagram 1014 is placed on a length of carriageway, then the road markings shall be so spaced apart that one follows in line behind the other.

**Placing of light signals prescribed in regulation 30(5) and in regulation 35 and signs and light signals shown in Schedule 11**

**44.** The light signals prescribed in regulation 30(5) and regulation 35 and the signs and light signals shown in any diagram in Schedule 11 may be displayed only on or near—

- (a) a motorway; or
- (b) a dual carriageway road.

**45.** The light signals prescribed in regulation 30(5) shall not be displayed over or in relation to a traffic lane at the same time as any sign shown in diagram 6001, 6002, 6003, 6006, 6006.1, 6008, 6009, 6009.1, 6009.2, 6011 or 6012 is also being displayed over or in relation to that same traffic lane and at the same place on that lane.

**46.** A sign shown in diagram 6021 or 6031.1 may be displayed only over a traffic lane and a sign shown in diagram 6006, 6006.1, 6006.2, 6008, 6008.1, 6009, 6009.1, 6009.2, 6009.3, 6022 or 6032.1 may be displayed only at the side of the carriageway to which the indications given by the sign relate, or projecting over part of that carriageway, so as to communicate information to drivers in all traffic lanes.

**Placing of light signals prescribed in regulation 32**

**47.** Portable light signals may be placed for the control of vehicular traffic only at a site approved by the traffic authority except—

- (a) where the signals are being operated and maintained by and are under the regular supervision of a constable during the progress of a temporary scheme of traffic control;
- (b) on a length of road along which—
  - (i) there is no junction carrying vehicular traffic to or from it; and
  - (ii) the width of the carriageway is temporarily restricted so as to carry only one line of traffic;
- (c) at a level crossing when work in relation to that crossing is being carried out; or
- (d) on a road adjacent to the temporary site of road, building or engineering works used for the movement of vehicles, materials, plant or equipment within the site of the works.

### Placing of various light signals

**48.**—(1) The light signals shown in diagram 4004 may be placed only in conjunction with the sign shown in diagram 545 when placed in conjunction with the plate shown in diagram 546 or 547.1.

(2) The light signals shown in diagram 4005 may be placed on or near a road only when the sign shown in diagram 548 in conjunction with the plate shown in diagram 548.1 is placed in advance of those signals.

(3) The light signals shown in diagram 4006 may be placed only in conjunction with the light signals shown in diagram 3014.

(4) The sign shown in diagram 4003 may be placed only in conjunction with the light signals shown in diagram 4002 for the purpose of conveying to pedestrians the indications specified in diagram 4003.

(5) The light signals shown in diagram 4002 may be placed only in conjunction with the light signals prescribed in paragraphs (2) or (3) of regulation 30.

(6) The light signal shown in diagram 776 may be placed only at or near a level crossing and the legend shall be displayed to road traffic in black letters on a red background which is internally illuminated by means of electricity only when a railway vehicle or tramcar has just passed over the level crossing and another is approaching.

### Approval of signs and signals

**49.**—(1) Save as provided in this direction, the light signals prescribed in regulations 30, 31, 32, 34, 35, 37 and 38, the matrix signs prescribed in regulation 36, the warning lights prescribed in regulations 39(2) and 40, the audible and tactile signals prescribed in regulation 37, a sign shown in diagram 618.3A, 776 or 2509, any light signals or signs shown in a diagram in Schedule 11, variable message signs and any other signs not continuously in use over a period of 24 hours and which are capable of being brought into and taken out of use by the operation of any electrical or other apparatus may be placed on or near a road only if at the time that they are first placed—

- (a) the signal, sign or any apparatus (including the content of all instructions stored in, or executable by it) used in connection with the signal or sign is approved in writing in accordance with the relevant requirements laid down by the Secretary of State; and
- (b) in the case of signals prescribed in regulation 30(7) or regulation 38 the signals are to be erected at or near a level crossing, and the site for, and the number and disposition of, those signals has first been approved in writing by or on behalf of the Secretary of State.

(2) Paragraph (1)(b) shall not apply to signals displayed to indicate the effect of Orders made by the Secretary of State under—

- (a) section 66 of the British Transport Commission Act 1957(**31**);
- (b) section 124 of the Transport Act 1968(**32**); or
- (c) section 1 of the Level Crossings Act 1983(**33**).

(3) If, after a signal or sign has been placed in accordance with an approval under paragraph (1), the signal, sign or any apparatus used in connection with the signal or sign is altered, the signal or sign shall not be further used unless that alteration is approved in writing by or on behalf of the Secretary of State.

(4) Paragraphs (1) and (3) shall not apply to variable message signs which are only manually operated without any assistance by electrical or mechanical means.

---

(31) 5 & 6 Eliz. 2 c.xxxiii.

(32) 1968 c. 73.

(33) 1983 c. 16.

*Status: This is the original version (as it was originally made). This item of legislation is currently only available in its original format.*

(5) When any signal or sign has been placed in accordance with an approval under paragraph (1), the signal, the sign or any apparatus used in connection with the signal or sign, including any alterations approved in accordance with paragraph (3), shall be regarded as continuing to be approved until notice is given in writing by the Secretary of State—

(a) to the traffic authority; and

(b) either—

(i) to the supplier of the equipment; or

(ii) where an alteration has been approved in accordance with paragraph (3), to the person who carried out the alteration,

of a date after which the signal, sign or apparatus is no longer to be so regarded.

(6) Where notice is given under paragraph (5) that a signal, sign or any apparatus used in connection with the signal or sign shall no longer be regarded as being approved that signal, sign or apparatus shall be removed from the road on or before the date given in the notice.

### **Approval of studs**

**50.**—(1) Studs incorporating reflectors, retroreflecting material or a steady or intermittent light source may be placed on a road only if such studs are approved in writing in accordance with requirements laid down by the Secretary of State.

(2) When any stud has been placed in accordance with an approval under paragraph (1), the stud shall be regarded as continuing to be approved until notice is given in writing by the Secretary of State to the supplier and to the traffic authority of a date after which the stud is no longer to be so regarded.

(3) Where notice is given under paragraph (2) that a stud is no longer to be regarded as being approved that stud shall be removed from the road on or before the date given in the notice.

### **Special directions by the Secretary of State**

**51.** Nothing in these Directions shall be taken to limit the power of the Secretary of State acting as the appropriate Minister by any special direction to dispense with, add to or modify any of the requirements of these Directions in their application to any particular case.



## APPENDIX 1

### EXERCISE OF POWERS

1. The Regulations in Part I of this Instrument are made by the Secretary of State for Transport, the Secretary of State for Scotland and the Secretary of State for Wales—

- (a) acting jointly, in exercise of the powers conferred on them by section 64 of the Road Traffic Regulation Act 1984<sup>(34)</sup> and section 36(5) of the Road Traffic Act 1988<sup>(35)</sup>; and
- (b) acting severally, in relation to England, to Scotland and to Wales respectively, in exercise of the powers conferred on them by section 28 of the said Act of 1984 and of all other enabling powers.

2. The Directions in Part II of this Instrument are given by the said Secretaries of State acting jointly, in exercise of the powers conferred on them by sections 65 and 85(2) of the said Act of 1984.

---

(34) 1984 c. 27. Section 64(5) was amended by the Road Traffic (Consequential Provisions) Act 1988, Schedule 3; section 65(1) was substituted by the New Roads and Street Works Act 1991, Schedule 8, paragraph 28; section 65(1A) was inserted by the Road Traffic Act 1991, Schedule 4, paragraph 29; and section 85(2) was amended by the New Roads and Street Works Act 1991, Schedule 8, paragraph 62. For the meaning of “the Ministers”, in section 64(1)(a) and section 65(1), and of “prescribed”, see section 142(1).

(35) 1988 c. 52.

**Status:** This is the original version (as it was originally made). This item of legislation is currently only available in its original format.

## APPENDIX 2

### INSTRUMENTS REVOKED

Regulation 2 and Direction 2

- Traffic Signs (Speed Limits) Regulations and General Directions 1969**(36)**
- Traffic Signs (Speed Limits) (Amendment) Regulations and General Directions 1977**(37)**
- \*Traffic Signs Regulations and General Directions 1981**(38)**
- \*Traffic Signs (Amendment) Regulations 1982**(39)**
- \*Traffic Signs General (Amendment) Directions 1982**(40)**
- \*Traffic Signs General (Amendment) Directions 1983**(41)**
- \*Traffic Signs (Amendment) Regulations 1983**(42)**
- \*Traffic Signs (Amendment) Regulations and General Directions 1984**(43)**
- Traffic Signs (Amendment) Regulations 1986**(44)**
- Traffic Signs General (Amendment) Directions 1987**(45)**
- Traffic Signs (Amendment) Regulations and General Directions 1989**(46)**
- Traffic Signs (Amendment) Regulations and General Directions 1990**(47)**

Signed by authority of the Secretary of State for Transport

20th May 1994

*Robert Key*  
Parliamentary Under Secretary of State  
Department of Transport

Signed by authority of the Secretary of State for Scotland

25th May 1994

*James Douglas-Hamilton*  
Parliamentary Under Secretary of State Scottish  
Office

---

**(36)** S.I. 1969/1487.  
**(37)** S.I. 1977/952.  
**(38)** S.I. 1981/859.  
**(39)** S.I. 1982/1879.  
**(40)** S.I. 1982/1880.  
**(41)** S.I. 1983/1086.  
**(42)** S.I. 1983/1088.  
**(43)** S.I. 1984/966.  
**(44)** S.I. 1986/1859.  
**(45)** S.I. 1987/1706.  
**(46)** S.I. 1989/2139.  
**(47)** S.I. 1990/704.

26th May 1994

*John Redwood*  
Secretary of State for Wales

---

## EXPLANATORY NOTE

(This Note is not part of the Instrument)

This Instrument in Part I consolidates with amendments the Traffic Signs Regulations 1981 ([S. I.1981/859](#)), and all subsequent relevant amending Instruments, and incorporates with amendments the Traffic Signs (Speed Limits) Regulations 1969 ([S. I.1969/1487](#)). The principal changes are—

1. Regulation 3 imposes deadlines on the replacement of signs rendered obsolete by these new Regulations.

2. A number of new and revised definitions are included in regulation 4.

3. Regulation 5 defines “speed limit” and speed limit signs are now shown in diagrams 670 to 674 in Schedule 2.

4. Regulation 10 additionally applies section 36 of the Road Traffic Act 1988 to the mini-roundabout sign shown in diagram 611.1, to the U-turn prohibition sign shown in diagram 614, to the mandatory height limit signs shown in diagrams 629.2 and 629.2A, to the yellow box markings shown in diagrams 1043, 1044 and 1045, to the “stop” signal for tramcars shown in diagram 3013.1 and to green arrow traffic light signals. The mandatory height limit signs and green arrow traffic light signals are also specified for the purposes of column 5 in Schedule 2 to the Road Traffic Offenders Act 1988.

5. Regulation 12 imposes a tighter limit of 10% for the amount by which road markings may be smaller than indicated in the diagrams in Schedule 6. New variations are specified for the heights of raised rib and other profiled road markings.

6. Regulation 14 makes provision for certain signs to be attached to police and road maintenance vehicles.

7. Regulation 15 exempts tramcars and trolley buses from the requirements of the “keep left” sign shown in diagram 610.

8. Regulation 17 specifies the permitted variants, but most of the details of the variants are now itemised in Schedule 16.

9. Regulations 18 to 21 specify the illumination requirements, but most of the details of these requirements are now itemised in Schedule 17.

10. Regulations 22 to 24 redefine the meaning of “buses” and the bus symbol to bring the definitions into line with the Transport Act 1985 and the Public Passenger Vehicles Act 1981. A period until 1 January 1997 is allowed for traffic regulation orders to be changed where necessary to incorporate the revised definitions.

11. Regulation 26 allows vehicles to cross the continuous line of a double white line system to overtake a road maintenance vehicle, pedal cycle or horse moving at no more than 10 miles per hour provided that the driver can see that it is safe to do so.

*Status: This is the original version (as it was originally made). This item of legislation is currently only available in its original format.*

12. Regulation 28 extends the list of road markings which must be illuminated by the use of retroreflecting material.

13. Regulation 29 introduces revised requirements for the heights of road markings and the sizes of retroreflecting road studs.

14. Regulation 30 specifies the circumstances in which each type of light signal can be used. New light signals are introduced for controlling tramcars.

15. Regulation 33 now includes a reference to the sign shown in diagram 7011 as well as to the stop line in specifying the significance of red traffic light signals. It also provides an exemption for tramcars from the requirement to stop at the standard red traffic light signal.

16. Regulations 35 and 36 now allows the flashing amber warning signal and matrix signs shown in Schedule 11 to be used on all-purpose dual carriageway roads as well as on motorways.

17. Regulation 38 prescribes a new light signal for pedestrians for use at certain level crossings.

18. Regulation 39 now allows the school warning lights shown in diagram 4004 to be operated when children are crossing whether or not a school crossing patrol is present. This will allow the lights to be controlled by automatic timing devices.

19. Regulation 40 prescribes cattle crossing signs and warning lights for the first time.

20. Regulation 41 prescribes the additional colour of blue legend on a white background for temporary signs to special events.

21. The requirements for road danger lamps in regulation 43 have been simplified by reference to the appropriate technical specifications.

22. Regulation 44 prescribes for the first time flat traffic delineators, and rotating retroreflecting devices for mounting on the top of traffic cones.

23. Regulation 46 prescribes the requirements for a wide range of variable message signs.

24. The Schedules of diagrams have been re-arranged to show separately the signs for level crossings, for bus, tramcar and pedal cycle facilities, and for road works. New signs have been introduced in each category of sign including:

- new designs of warning and regulatory signs for low bridges;
- warning signs for junctions on bends, farm traffic, helicopters, slow lorries, military vehicles, side winds, soft verges, wild fowl and toads;
- regulatory signs for pedestrian zones, weak bridges, taxi ranks, voucher and Pay & Display parking facilities;
- speed limit signs which are now shown in these regulations instead of in a separate Instrument;
- new designs of level crossing signs;
- a new range of signs and signals for tramcars;
- raised rib edge line road markings, a rationalised system of yellow lines for waiting restrictions, and a wider range of hatched markings;
- a revised and extended system of colour-coding by route for directional signs, white on brown signs to tourist attractions, and a wider range of directional signs to off-street car parks;
- a new design of green arrow signal, matrix signs for fog and to indicate the end of restrictions, and new designs of lane control signals;
- a new range of signs for road works.

There is greater use of tabular presentation and cross-referencing to the information relating to a particular sign. A table, giving the cross-references to the appropriate regulations, directions, other

diagrams and to the permitted variants and illumination requirements, appears below each diagram in the Schedules. These tables are explained in regulation 7.

Part II of the Instrument consolidates with amendments the Traffic Signs General Directions 1981, which constituted Part II of The Traffic Signs Regulations and General Directions 1981 (S. I.1981/859), and all subsequent relevant amending Instruments, and incorporates with amendments Part II of the Traffic Signs (Speed Limits) Regulations and General Directions 1969 (S. I.1969/1487). The principal changes are—

1. The directions have been re-grouped and sub-headings introduced.
2. Direction 3 includes a number of new definitions.
3. Direction 6 requires site approval for the use of the new permitted variant of the hatched marking shown in diagrams 1040 and 1040.2 with a continuous white boundary line.
4. Direction 7 now excludes the yellow box road markings shown in diagrams 1044 and 1045 from the requirement to be supported by a traffic regulation order.
5. Directions 8, 9 and 10 set out the requirements for placing signs at the beginning and end of restrictions, requirements, prohibitions or speed limits, and for repeater signs.
6. Directions 11 to 13 specify which directional signs are to be used only on which types of road in accordance with the new colour-coding system.
7. Directions 20 and 21 specify the new requirements for the use of yellow lines and kerb markings to indicate waiting and loading restrictions. Direction 22 includes provision for dispensing with the need for these markings in certain types of pedestrian zone. Directions 23 and 24 specify which vertical signs shall be used with these markings and clarify the requirements for signing in controlled parking zones.
8. Direction 26 specifies the conditions for the use of the toad warning sign shown in diagram 551.1 in Schedule 1 to the Regulations.
9. Direction 33 restricts the use of the sign to housing developments shown in diagram 2701 in Part VIII of Schedule 7 to the Regulations.
10. Directions 36 and 37 allow the posts and backs of most signs made from aluminium or galvanised metal to remain in their natural colour.
11. Direction 44 now allows the matrix signs shown in Schedule 11 to the Regulations to be used on all-purpose dual carriageway roads as well as on motorways.
12. Direction 49 includes rationalised requirements for the type approval of light signals, matrix signals and variable message signs.

Copies of the British Standard specifications referred to in this Instrument can be obtained from any of the sales outlets operated by the British Standards Institution, or by post from that Institution at Linford Wood, Milton Keynes, MK14 6LE (telephone number 0908 320066).