

---

STATUTORY INSTRUMENTS

---

**2002 No. 3113**

**ROAD TRAFFIC**

**The Traffic Signs Regulations and General Directions 2002**

*Made* - - - - *16th December 2002*

*Laid before Parliament* *10th January 2003*

*Coming into force* - - *31st January 2003*

The Secretary of State for Transport, in exercise of the powers conferred by sections 64, 65 and 85(2) of the Road Traffic Regulation Act 1984(1) and by section 36(5) of the Road Traffic Act 1988(2) and now vested in him(3), hereby—

- (a) after consultation with representative organisations in accordance with section 134(2) of the Road Traffic Regulation Act 1984 and section 195(2) of the Road Traffic Act 1988, makes the Regulations set out in Part I of this Instrument, and
- (b) gives the Directions set out in Part II.

**PART I**

**THE TRAFFIC SIGNS REGULATIONS 2002**

*SECTION 1*

*PRELIMINARY*

**Citation and commencement**

**1. This Part of this Instrument—**

- 
- (1) 1984 c. 27. Section 64 was amended by the Road Traffic (Consequential Provisions) Act 1988 (c. 54), Schedule 3, paragraph 25, the Roads (Scotland) Act 1984 (c. 54), Schedule 9, paragraph 93, and the New Roads and Street Works Act 1991 (c. 22), Schedule 8, paragraph 47. Amendments were made relating to the exercise of powers under section 64 by S.I. 1999/672, 1750 and 3143. Section 65 was amended by the Roads (Scotland) Act 1984, Schedule 9, paragraph 93, the Local Government and Housing Act 1989 (c. 42), section 153, the New Roads and Street Works Act 1991, Schedule 8, paragraph 48 and the Road Traffic Act 1991 (c. 40), Schedule 4, paragraph 29. Amendments were made relating to the exercise of powers under section 65 by S.I. 1999/672, 1750 and 3143. Section 85(2) was amended by the New Roads and Street Works Act 1991, Schedule 8, paragraph 62 and by the Road Traffic Act 1991, Schedule 4, paragraph 30 and Schedule 8. Amendments were made relating to the exercise of powers under section 85(2) by S.I. 1999/672 and 1750.
  - (2) Section 36(5) was amended by S.I. 1997/2971. Amendments were made relating to the exercise of powers under section 36(5) by S.I. 1999/672, 1750 and 3143.
  - (3) S.I. 1999/3143.

- (a) may be cited—
  - (i) as the Traffic Signs Regulations 2002, and
  - (ii) together with Part II below, as the Traffic Signs Regulations and General Directions 2002; and
- (b) shall come into force on 31st January 2003.

## Revocations

2. The Traffic Signs Regulations 1994<sup>(4)</sup> and the Traffic Signs (Amendment) Regulations 1995<sup>(5)</sup> are hereby revoked.

## Savings

3.—(1) Subject to paragraph (2), any traffic sign which immediately before the coming into force of these Regulations was placed on or near a road shall be treated as prescribed by these Regulations, notwithstanding any provisions of these Regulations to the contrary, provided that—

- (a) it is a sign prescribed, or to be treated as if prescribed, by the 1981 Regulations or by the 1994 Regulations; and
- (b) it continues to comply with those Regulations,

as if those Regulations had not been revoked.

(2) Paragraph (1) shall cease to have effect—

- (a) on 1st January 2005 in relation to the signs shown in each of the following diagrams—
  - (i) in the Traffic Signs Regulations 1957<sup>(6)</sup>, diagrams 403 to 405, 412A to 418, 422 to 433, 435 to 459, 468 to 472, and 474 to 495;
  - (ii) in the Traffic Signs Regulations 1964<sup>(7)</sup>, diagrams 742, 746, 837 and 838;
  - (iii) in the 1981 Regulations, diagrams 626.1, 627, 628.1, 641, 642.1, 649.2, 653, 734.7, 739.3, 742.1, 742.2, 742.3, 742.4, 742.5, 742.6, 747, 748, 749, 750, 751, 752, 752.1, 753, 753.1, 758, 759, 837.1, 838.1 and 905;
  - (iv) in the 1994 Regulations, diagrams 618.1 (when varied to include the legend “buses and coaches”), 784, 818.1 (when varied to show a distance greater than 2 miles), 820 (when varied to include the legend “buses and coaches”), 954.1 and 1028.2 (when varied to “COACHES”); and
  - (v) in the 1994 Regulations, diagrams 958, 959 and 960, in each case when varied to include the legend “& coaches”;
- (b) on 1st January 2007 in relation to the signs shown in diagrams 622.1A (when varied to show “17T”), 626.2 (when displaying “17T” or “25T”), 1025 and 1025.2 in the 1994 Regulations;
- (c) on 1st January 2010 in relation to—
  - (i) the signals prescribed by regulation 31(3) of the 1981 Regulations;
  - (ii) the sign shown in diagram 661 in the 1994 Regulations; and
  - (iii) the signs shown in diagrams 618.1, 618.2, 618.3, 618.3A and 620 in the 1994 Regulations when varied to include the orange badge symbol shown in diagram 661 in those Regulations;

---

(4) Part I of S.I. 1994/1519.

(5) Part I of S.I. 1995/3107.

(6) S.I. 1957/13, amended by S.I. 1957/2149, 1959/761, 1960/1095.

(7) S.I. 1964/1857, amended by S.I. 1966/490, 1969/1269, 1970/468, 1970/1972, 1971/2095.

- (d) on 1st January 2015 in relation to—
- (i) the signs shown in diagrams 728.1, 728.2, 729, 729.1, 729.2, 729.3, 730, 730.1, 732, 732.1, 732.2, 733, 733.1, 734.1, 734.2, 734.3, 734.4, 734.5, 734.6, 734.8, 734.9, 734.10, 736, 736.1, 737.1, 760 and 761 in the 1981 Regulations; and
  - (ii) the signs shown in diagrams 2308, 2309, 2310, 2311, 2313, 2314, 2315, 2315.1 and 2919 of the 1994 Regulations.
- (3) Subject to paragraph (4), portable light signals which do not comply with regulation 35 shall be treated as prescribed by these Regulations if and so long as—
- (a) those signals are of the size, colour and type prescribed by regulation 32 of the 1994 Regulations; and
  - (b) those signals and any apparatus (including the content of all instructions stored in, or executable by them) used in connection with them are the subject of an approval given and for the time being in force under direction 49 of the Traffic Signs General Directions 1994(8).
- (4) Paragraph (3) shall cease to have effect on 1st January 2015.
- (5) Notwithstanding regulation 2, the 1994 Regulations shall be treated, in relation to a paragraph (6) sign, as remaining in force during the extension period.
- (6) In paragraph (5)—
- (a) “the extension period” means the period of 12 weeks beginning with the day on which these Regulations come into force; and
  - (b) “a paragraph (6) sign” is a sign which is of the size, colour and type shown in diagram 547.5, 547.6, 626.2, 629, 639.1A, 642.2, 643, 644, 661, 661.2, 661.3, 780, 780.1, 780.2, 784, 785, 832.10, 864, 872, 2010, 2206, 2207, 2308, 2309, 2919, 2920, 3001, 3001.1, 4002, 7002, 7003, 7007 or 7010 of the 1994 Regulations.

### **Interpretation—general**

4. In these Regulations unless the context otherwise requires—
- “the 1984 Act” means the Road Traffic Regulation Act 1984;
  - “the 1988 Act” means the Road Traffic Act 1988;
  - “the 1981 Regulations” means the Traffic Signs Regulations 1981(9);
  - “the 1994 Regulations” means the Traffic Signs Regulations 1994;
  - “articulated vehicle” means a motor vehicle with a trailer so attached to it as to be partially superimposed upon it;
  - “automatic half-barrier level crossing” means a level crossing where barriers are installed to descend automatically across part of the road when a railway vehicle or tramcar approaches and the operation of the barriers is monitored remotely from the crossing;
  - “automatic barrier crossing (L)” means a level crossing where barriers are installed to descend automatically across part of the road when a railway vehicle or tramcar approaches and the driver of the railway vehicle or tramcar is required to monitor the operation of the barriers when the railway vehicle or tramcar is at or near the crossing;
  - “automatic open crossing (L)” means a level crossing without automatic barriers where light signals are so installed as to be operated automatically by a railway vehicle or tramcar

---

(8) Part II of S.I. 1994/1519.

(9) S.I. 1981/859, amended by S.I. 1982/1879, 1982/1880, 1983/1086, 1983/1088, 1984/966, 1986/1859, 1987/1706, 1989/2139, 1990/704.

approaching the crossing and the driver of the railway vehicle or tramcar is required to monitor the operation of the light signals when the railway vehicle or tramcar is at or near the crossing;

“automatic open crossing (R)” means a level crossing without automatic barriers where light signals are so installed as to be operated automatically by a railway vehicle or tramcar approaching the crossing and the operation of the light signals is monitored remotely from the crossing;

“automatic level crossing” means an automatic half-barrier level crossing, an automatic barrier crossing (L), an automatic open crossing (L) or an automatic open crossing (R);

“bus lane” has the meaning given in regulation 23;

“central reservation” means—

- (a) any land between the carriageways of a road comprising two carriageways; or
- (b) any permanent work (other than a traffic island) in the carriageway of a road,

which separates the carriageway or, as the case may be, the part of the carriageway which is to be used by traffic moving in one direction from the carriageway or part of the carriageway which is to be used (whether at all times or at particular times only) by traffic moving in the other direction;

“contra-flow” means a part of a carriageway of a road where—

- (a) traffic is authorised to proceed in the opposite direction to the usual direction of traffic on that part; or
- (b) a specified class of traffic is authorised to proceed in the opposite direction to other traffic on that carriageway;

“controlled parking zone” means either—

- (a) an area—
  - (i) in which, except where parking places have been provided, every road has been marked with one or more of the road markings shown in diagrams 1017, 1018.1, 1019 and 1020.1; and
  - (ii) into which each entrance for vehicular traffic has been indicated by the sign shown in diagram 663 or 663.1; or
- (b) an area—
  - (i) in which at least one of the signs shown in diagram 640.2A has been placed on each side of every road; and
  - (ii) into which each entrance for vehicular traffic has been indicated by the sign shown in diagram 665;

“cycle lane” means a part of the carriageway of a road which—

- (a) starts with the marking shown in diagram 1009; and
- (b) is separated from the rest of the carriageway—
  - (i) if it may not be used by vehicles other than pedal cycles, by the marking shown in diagram 1049; or
  - (ii) if it may be used by vehicles other than pedal cycles, by the marking shown in diagram 1004 or 1004.1;

“cycle track”, in relation to England and Wales, has the same meaning as in the Highways Act 1980<sup>(10)</sup> and, in relation to Scotland, as in the Roads (Scotland) Act 1984<sup>(11)</sup>;

---

<sup>(10)</sup> 1980 c. 66.

<sup>(11)</sup> 1984 c. 54.

“dual carriageway road” means a road which comprises a central reservation and “all-purpose dual carriageway road” means a dual carriageway road which is not a motorway;

“EEA Agreement” means the Agreement on the European Economic Area signed at Oporto on 2nd May 1992 as adjusted by the Protocol signed at Brussels on 17th March 1993<sup>(12)</sup>;

“EEA Standard” means—

- (a) a standard or code of practice of a national standards body or equivalent body of any EEA State;
- (b) any international standard recognised for use as a standard or code of practice by any EEA State; or
- (c) a technical specification recognised for use as a standard by a public authority of any EEA State,

and a reference to a “corresponding EEA Standard”, in relation to a British or European Standard, is a reference to an EEA Standard which requires a level of performance equivalent to that required by the British or European Standard;

“EEA State” means a State which is a contracting Party to the EEA Agreement;

“enactment” includes any Act or subordinate legislation as defined in section 21(1) of the Interpretation Act 1978<sup>(13)</sup>;

“equestrian crossing” means a place on the carriageway of a road—

- (a) where provision is made for equestrian traffic to cross the carriageway; and
- (b) whose presence is indicated by a combination of—
  - (i) traffic light signals to control vehicular traffic of the kind prescribed by regulation 33;
  - (ii) the signals shown in diagrams 4003.2 and 4003.3, or the signal shown in diagram 4003.4; and
  - (iii) the road marking shown in diagram 1055.1 or 1055.2;

“ES compliant” in relation to signal heads shall be construed in accordance with regulation 33(5);

“excursion or tour” has the meaning given in section 137(1) of the Transport Act 1985<sup>(14)</sup>;

“goods vehicle” means a motor vehicle or trailer constructed or adapted for use for the carriage or haulage of goods or burden of any description;

“hours of darkness” means the time between half an hour after sunset and half an hour before sunrise;

“junction” means a road junction;

“level crossing” means a place where a road is crossed by a railway or a tramway on a reserved track on the same level;

“local bus” means a public service vehicle used for the provision of a local service not being an excursion or tour;

“local service” has the meaning given in section 2 of the Transport Act 1985;

“major road” means the road at a junction into which there emerges vehicular traffic from a minor road;

---

<sup>(12)</sup> Cmnd 2073 and 2183.

<sup>(13)</sup> 1978 c. 30.

<sup>(14)</sup> 1985 c. 67.

“manually operated” means a change from one sign to another or one signal aspect to another set in process by an operator;

“maximum gross weight” means—

- (a) in the case of a motor vehicle not drawing a trailer or in the case of a trailer, its maximum laden weight;
- (b) in the case of an articulated vehicle, its maximum laden weight (if it has one) and otherwise the aggregate maximum laden weight of all the individual vehicles forming part of that articulated vehicle; and
- (c) in the case of a motor vehicle (other than an articulated vehicle) drawing one or more trailers, the aggregate maximum laden weight of the motor vehicle and the trailer or trailers drawn by it;

“maximum laden weight” in relation to a vehicle (including a vehicle which is a trailer) means—

- (a) in the case of a vehicle as respects which a gross weight not to be exceeded in Great Britain is specified in construction and use requirements (as defined by section 41(8) of the 1988 Act), the weight so specified;
- (b) in the case of a vehicle as respects which no such weight is so specified, the weight which the vehicle is designed or adapted not to exceed when in normal use and travelling on a road laden;

“minor road” means a road on which, at its junction with another road, there is placed the sign shown in diagram 601.1 or 602 or the road marking shown in diagram 1003;

“mobile road works” means works on a road carried out by or from a vehicle or vehicles which move slowly along the road or which stop briefly from time to time along that road;

“motorway” means a special road which—

- (a) in England or Wales (save as otherwise provided by or under regulations made under, or having effect as if made under, section 17 of the 1984 Act<sup>(15)</sup>) can be used by traffic only of Class I or II as specified in Schedule 4 to the Highways Act 1980<sup>(16)</sup>; or
- (b) in Scotland can be used by traffic only of Class I or Class II as specified in Schedule 3 to the Roads (Scotland) Act 1984;

“mph” means miles per hour;

“non-primary route” means a route, not being a primary route or a motorway or part of a primary route or of a motorway;

“passenger vehicle” means a vehicle constructed or adapted for the carriage of passengers and their effects;

“pedal cycle” means a unicycle, bicycle, tricycle, or cycle having four or more wheels, not being in any case mechanically propelled unless it is an electrically assisted pedal cycle of such class as is to be treated as not being a motor vehicle for the purposes of the 1984 Act<sup>(17)</sup>;

“pedestrian zone” means an area—

- (a) which has been laid out to improve amenity for pedestrians; and
- (b) to which the entry of vehicles is prohibited or restricted;

---

<sup>(15)</sup> Section 17 was amended by the New Roads and Street Works Act 1991, Schedule 8, paragraph 28 and Schedule 9 and by the Road Traffic Act 1991, Schedule 4, paragraph 25 and Schedule 8.

<sup>(16)</sup> Schedule 4 was amended by the Road Traffic (Consequential Provisions) Act 1988 (c. 54), section 4 and Schedule 3, paragraph 21(3).

<sup>(17)</sup> See section 140(1)(c).

“plate” means a sign which by virtue of general directions given in exercise of the power conferred by section 65 of the 1984 Act may be placed only in combination or in conjunction with another sign and which is supplementary to that other sign;

“police vehicle” means a vehicle being used for police purposes or operating under the instructions of a chief officer of police;

“primary route” means a route, not being a route comprising any part of a motorway, in respect of which the Secretary of State—

- (a) in the case of a trunk road is of the opinion, and
- (b) in any other case after consultation with the traffic authority for the road comprised in the route is of the opinion,

that it provides the most satisfactory route for through traffic between places of traffic importance;

“primary signals” has the meaning given by regulation 43(5)(a);

“principal road” means a road for the time being classified as a principal road—

- (a) by virtue of section 12 of the Highways Act 1980 (whether as falling within subsection (1) or classified under subsection (3)), or
- (b) by the Secretary of State under section 11(1) of the Roads (Scotland) Act 1984;

“public service vehicle” has the meaning given in section 1 of the Public Passenger Vehicles Act 1981(18);

“reflectorised” means illuminated by the use of retroreflecting material;

“retroreflecting material” means material which reflects a ray of light back towards the source of that light;

“road maintenance vehicle” means a vehicle which—

- (a) in England and Wales is specially designed or adapted for use on a road by or on behalf of a highway authority for the purposes of the Highways Act 1980 for the purposes of road maintenance; or
- (b) in Scotland is specially designed or adapted for use on a road by or on behalf of a roads authority for the purposes of the Roads (Scotland) Act 1984 for the purposes of road maintenance;

“road marking” means a traffic sign consisting of a line or mark or legend on a road;

“road works” means works for the improvement, alteration or maintenance of a road and includes, in relation to England and Wales, street works as defined by section 48(3) of the New Roads and Street Works Act 1991 and, in relation to Scotland, road works as defined by section 107(3) of that Act;

“route” includes any road comprised in a route;

“school crossing place” means a place in a road where children cross or seek to cross that road on their way to or from school or on their way from one part of a school to another;

“secondary signals” has the meaning given by regulation 43;

“sign” means a traffic sign;

“signal-controlled crossing facility” means—

- (a) an equestrian crossing;
- (b) a signal-controlled pedestrian facility; or
- (c) a Toucan crossing;

---

(18) 1981 c. 14; section 1 was amended by the Transport Act 1985, section 139(3) and Schedule 8.

“signal-controlled pedestrian facility” means a place on the carriageway of a road—

- (a) which is not a “crossing” as defined by section 25(6) of the 1984 Act;
- (b) where provision is made for pedestrians to cross the carriageway; and
- (c) whose presence is indicated by a combination of—
  - (i) traffic light signals to control vehicular traffic of the kind prescribed by regulation 33;
  - (ii) the signals shown in diagrams 4002.1 and 4003, or the signal shown in diagram 4003.1; and
  - (iii) the road marking shown in diagram 1055.1 or 1055.2;

“single carriageway road” means a road which is not a dual carriageway road;

“solo motor cycle” means a motor cycle without a side car and having two wheels;

“stop line” in relation to light signals for the control of vehicular traffic has the meaning given in regulation 43;

“stud” means a prefabricated device fixed or embedded as a mark in the carriageway of a road;

“taxi” means—

- (a) in England and Wales, a vehicle licensed under—
  - (i) section 37 of the Town Police Clauses Act 1847**(19)**; or
  - (ii) section 6 of the Metropolitan Public Carriage Act 1869**(20)**;
 or under any similar enactment; and
- (b) in Scotland, a taxi licensed under section 10 of the Civic Government (Scotland) Act 1982**(21)**;

“taxi rank” means an area of carriageway reserved for use by taxis waiting to pick up passengers;

“telecommunications apparatus” has the meaning given by paragraph 1(1) of Schedule 2 to the Telecommunications Act 1984**(22)**;

“temporary statutory provision” means—

- (a) a provision having effect under section 9 (experimental traffic orders) or section 14 (temporary restriction of traffic on roads) of the 1984 Act or under a provision referred to in section 66 (traffic signs for giving effect to local traffic regulations) of that Act;
- (b) a prohibition, restriction or requirement indicated by a traffic sign placed pursuant to section 67 (emergencies and temporary obstructions) of the 1984 Act**(23)**; or
- (c) a provision having effect under section 62 (temporary prohibition or restriction of traffic etc. on roads for reasons of safety or public convenience) of the Roads (Scotland) Act 1984;

---

**(19)** 1847 c. 89; section 37 was amended by the Transport Act 1985 (c. 67) sections 16(a) and 139(3) and Schedule 8.

**(20)** 1869 c. 115; section 6 was amended by the Statute Law (Repeals) Act 1976 (c. 16) and by the Transport Act 1976 (c. 16) and by the Transport Act 1981 sections 35(1) and 40(1) and Schedule 12 Part III.

**(21)** 1982 c. 45.

**(22)** 1984 c. 12.

**(23)** Section 9 was amended by the New Roads and Street Works Act 1991, Schedule 8, paragraph 23, by the Road Traffic Act 1991, Schedule 4, paragraph 24 and by the Local Government Act 1985 (c. 51), Schedule 4, paragraph 4(4). Section 14 was substituted by the Road Traffic (Temporary Restrictions) Act 1991 (c. 26), Schedule 1 and amended by the National Parks (Scotland) Act 2000 (asp 10), Schedule 5, paragraph 11(1). Section 66 was amended by the Roads (Scotland) Act 1984, Schedule 3, paragraph 25(4), by the New Roads and Street Works Act 1991, Schedule 8, paragraph 49 and by the Road Traffic (Consequential Provisions) Act 1988 (c. 54), Schedule 3, paragraph 25(4). Section 67 was amended by the Road Traffic (Temporary Restrictions) Act 1991, section 1(3), by the New Roads and Street Works Act 1991, Schedule 8, paragraph 51, Schedule 9 and by the Road Traffic Regulation (Special Events) Act 1994 (c. 11), Schedule, paragraph 1.



“terminal sign” means a sign placed in accordance with direction 8 or 9 of the Traffic Signs General Directions 2002(24);

“Toucan crossing” means a place on the carriageway of a road—

- (a) where provision is made for both pedestrians and pedal cyclists to cross the carriageway; and
- (b) whose presence is indicated by a combination of—
  - (i) traffic light signals to control vehicular traffic of the kind prescribed by regulation 33;
  - (ii) the signals shown in diagrams 4003.5 and 4003.6, or the signal shown in diagram 4003.7; and
  - (iii) the road marking shown in diagram 1055.1 or 1055.2;

“tourist destination” means a permanently established attraction or facility which—

- (a) attracts or is used by visitors to an area;
- (b) is open to the public without prior booking during its normal opening hours;
- (c) if located in Scotland, is recognised by VisitScotland; and
- (d) if located in Wales, is recognised by the Wales Tourist Board;

“Tourist Information Centre” means a staffed information service centre recognised and supported by the English or Wales Tourist Board or by VisitScotland;

“Tourist Information Point” means a display of tourist information approved by a regional, area or local tourist board;

“traffic calming features” means—

- (a) road humps constructed pursuant to section 90A of the Highways Act 1980(25) (“the 1980 Act”) or section 36 of the Roads (Scotland) Act 1984(26) (“the Scotland 1984 Act”) and in accordance with the Highways (Road Humps) Regulations 1999(27) or the Road Humps (Scotland) Regulations 1998(28); or
- (b) traffic calming works constructed in accordance with section 90G of the 1980 Act(29) or section 39A of the Scotland 1984 Act(30) and in accordance with the Highways (Traffic Calming) Regulations 1999(31) or the Roads (Traffic Calming) (Scotland) Regulations 1994(32);

“traffic lane” means, in relation to a road, a part of the carriageway having, as a boundary which separates it from another such part, a road marking of the type shown in diagram 1004, 1004.1, 1005, 1005.1, 1008, 1008.1, 1010, 1013.1, 1013.3, 1013.4, 1040, 1040.2, 1041, 1041.1, 1042, 1042.1 or 1049;

“tramcar” has the meaning given in section 141A(4) of the 1984 Act(33);

“trolley vehicle” has the meaning given in section 141A(4) of the 1984 Act;

---

(24) Part II of this Instrument.

(25) 1980 c. 66. Section 90A was inserted by the Transport Act 1981 (c. 56), section 32(1), Schedule 10 Part I, paragraph 2.

(26) Section 36 was amended by the Road Traffic Act 1991, Schedule 4, paragraph 38.

(27) S.I. 1999/1025.

(28) S.I. 1998/1448; relevant amending instrument is S.I. 1999/1000.

(29) Section 90G was inserted by the Traffic Calming Act 1992 (c. 30), section 1(2), Schedule 1.

(30) Section 39A was inserted by the Traffic Calming Act 1992 (c. 30), Schedule 2.

(31) S.I. 1999/1026.

(32) S.I. 1994/2488; relevant amending instrument is S.I. 1999/1000.

(33) Section 141A was inserted by the Road Traffic Act 1991 (c. 40), section 46 and was amended by the Schedule to the Road Traffic Regulation (Special Events) Act 1994 (c. 11).

“trunk road” as respects England and Wales has the meaning given in section 329(1) of the Highways Act 1980 and as respects Scotland in section 151(1) of the Roads (Scotland) Act 1984;

“unladen vehicle” has the meaning given in Schedule 18;

“variable message sign” has the meaning given in regulation 58(1);

“with-flow lane” means a traffic lane reserved for a specified class of traffic proceeding in the same direction as general traffic in an adjoining traffic lane;

“Zebra crossing” has the meaning given by regulation 3(1) of the Zebra, Pelican and Puffin Pedestrian Crossings Regulations 1997<sup>(34)</sup>; and

“zig-zag line” means a road marking of the size, colour and type shown in diagram 1001.3 which has been placed along a length of carriageway adjacent to a signal-controlled crossing facility.

### Interpretation of speed limit

5.—(1) In these Regulations “speed limit” means a maximum or minimum limit of speed on the driving of vehicles on a road—

- (a) imposed by an order under section 14 of the 1984 Act (temporary prohibition or restriction of traffic on roads);
- (b) imposed by an order under section 16A of the 1984 Act<sup>(35)</sup> (special events);
- (c) imposed by regulations under section 17 of the 1984 Act (traffic regulation on special roads);
- (d) arising by virtue of the road being restricted for the purposes of section 81 of the 1984 Act (general speed limit for restricted roads);
- (e) imposed by an order under section 84 of the 1984 Act (speed limits on roads other than restricted roads);
- (f) imposed by an order under section 88 of the 1984 Act (temporary speed limits); or
- (g) imposed by or under a local Act,

and “maximum speed limit” and “minimum speed limit” shall be construed accordingly.

(2) In these Regulations “national speed limit” means any prohibition imposed on a road by the 70 miles per hour, 60 miles per hour and 50 miles per hour (Temporary Speed Limit) Order 1977<sup>(36)</sup> or by regulation 3 of the Motorways (Speed Limits) Regulations 1974<sup>(37)</sup>.

### Interpretation of references

6. In these Regulations, unless it is expressly provided otherwise or the context otherwise requires—

- (a) a reference to a numbered regulation is a reference to the regulation so numbered in these Regulations;
- (b) a reference to a numbered paragraph is a reference to the paragraph so numbered in the regulation or Schedule in which the reference occurs;

---

<sup>(34)</sup> Part I of S.I. 1997/2400, to which there are amendments not relevant to these Regulations.

<sup>(35)</sup> Section 16A was inserted by the Road Traffic Regulation (Special Events) Act 1994, section 1(1).

<sup>(36)</sup> This Order is not a Statutory Instrument. It was amended by the 70 miles per hour, 60 miles per hour and 50 miles per hour (Temporary Speed Limit) (Variation) Order 1978 and its provisions were continued in force indefinitely by the 70 miles per hour, 60 miles per hour and 50 miles per hour (Temporary Speed Limit) (Continuation) Order 1978, S.I. 1978/1548.

<sup>(37)</sup> S.I. 1974/502.

- (c) a reference to a sub-paragraph followed by a number or letter is a reference to the sub-paragraph bearing that number or letter in the paragraph in which the reference occurs;
- (d) a reference to a numbered diagram is a reference to the diagram so numbered in a Schedule to these Regulations;
- (e) a reference to a sign, signal, signals or road marking prescribed by a regulation or shown in a diagram in a Schedule to these Regulations means a sign, signal, signals or road marking of the size, colour and type—
  - (i) prescribed by that regulation and shown in any diagram to which that regulation refers; or as the case may be
  - (ii) shown in that diagram and prescribed by these Regulations,and in either case includes a reference to that sign, signal, signals or road marking as varied in accordance with these Regulations;
- (f) a reference to the information, warning, requirement, restriction, prohibition or speed limit conveyed by a sign, signal, signals or road marking prescribed by a regulation or shown in a diagram includes a reference to that information, warning, requirement, restriction, prohibition or speed limit, however expressed, as varied to accord with any variation of the sign, signal, signals or road marking made in accordance with these Regulations; and
- (g) in any provision which includes a table, references to a table or to a numbered table are to the table or as the case may be to the table so numbered in that provision.

### **Interpretation of Schedules 1 to 12**

7.—(1) In any untitled table under or beside any diagram (in this paragraph referred to as “the diagram”) in Schedules 1 to 12—

- (a) in item 1 any regulations which are specified are regulations in these Regulations in which a specific reference is made to the diagram, to a regulation or Schedule which refers to the diagram or to a symbol which appears in the diagram or a variant of the diagram;
- (b) in item 2 any directions which are specified are directions in the Traffic Signs General Directions 2002(38) containing a reference to the particular diagram or to a regulation or Schedule which refers to the diagram;
- (c) in item 3 any diagrams which are specified are diagrams in the Schedules to these Regulations which show signs which may or must be placed in conjunction or in combination with the sign shown in the diagram;
- (d) in item 4 any item which is specified is an item in Schedule 16 which specifies permitted variants to the diagram; and
- (e) in item 5 any item which is specified is an item in Schedule 17 which specifies the illumination requirements for the sign shown in the diagram.

(2) The table entitled “Table of combinations” under or beside any diagram in Part III of Schedule 12 indicates the manner in which the sign shown in that diagram may be varied in accordance with paragraphs (7) to (9) of regulation 17.

(3) Dimensions indicated on any diagram shown in Schedules 1 to 12 are expressed in millimetres unless otherwise specified.

*SECTION 2*  
*GENERAL PROVISIONS*

**Authorisations**

**8.** Nothing in these Regulations shall be taken to limit the powers of the Secretary of State, the Scottish Ministers and the National Assembly for Wales under section 64(1) and (2) of the 1984 Act<sup>(39)</sup> to authorise the erection or retention of traffic signs of a character not prescribed by these Regulations.

**Temporary obstructions**

**9.** Nothing in these Regulations shall have effect so as to authorise any persons not otherwise authorised to do so to place on or near a road any object or device for warning traffic of a temporary obstruction.

**Application of section 36 of the Road Traffic Act 1988 to signs and disqualification for offences**

**10.**—(1) Section 36 of the 1988 Act shall apply to each of the following signs—

- (a) the signs shown in diagrams 601.1, 602, 606, 609, 610, 611.1, 615, 616, 626.2A, 629.2, 629.2A, 784.1, 953, 953.1, 7023, 7029 (except when varied to omit the legend “NO OVERTAKING”), 7031 and 7403;
- (b) the road marking shown in diagram 1001.3;
- (c) the road marking shown in diagram 1003;
- (d) the road markings shown in diagrams 1013.1, 1013.3 and 1013.4 insofar as those markings convey the requirements specified in regulation 26;
- (e) the road markings shown in diagrams 1025.1, 1025.3 and 1025.4 insofar as those markings convey the prohibition specified by regulation 29(1) and Part I of Schedule 19;
- (f) the road markings shown in diagrams 1042, 1042.1, 1043, 1044 and 1045;
- (g) the red light signal when displayed by the light signals prescribed by regulation 33 or by regulation 35;
- (h) the light signals prescribed by regulation 33 as varied in accordance with regulation 34 when they are displaying one or more of the green arrow signals shown in diagrams 3001.2 or 3001.3 insofar as they convey any of the restrictions specified in regulation 36(1)(f) or (g);
- (i) the light signal shown in diagram 3013.1;
- (j) the intermittent red light signals when displayed by the sign shown in diagram 3014; and
- (k) the light signals prescribed by regulation 37 and shown in diagrams 6031.1 and 6032.1 when indicating one of the prohibitions prescribed by regulation 38.

(2) The following signs are hereby specified for the purposes of column 5 of the entry in Schedule 2 to the Road Traffic Offenders Act 1988<sup>(40)</sup> relating to offences under section 36 of the 1988 Act—

- (a) the signs shown in diagrams 601.1, 616, 629.2, 629.2A and 784.1;
- (b) the road marking shown in diagram 1001.3;

---

<sup>(39)</sup> See S.I. 1999/672 and 1750.

<sup>(40)</sup> 1988 c. 53.

- (c) the road markings shown in diagram 1013.1, 1013.3 or 1013.4 insofar as those markings convey the requirements specified in regulation 26;
- (d) the red light signal when displayed by the light signals prescribed by regulation 33 or by regulation 35;
- (e) the light signals prescribed by regulation 33 as varied in accordance with regulation 34 when they are displaying one or more of the green arrow signals shown in diagrams 3001.2 or 3001.3 insofar as they convey any of the restrictions specified in regulation 36(1)(f) or (g);
- (f) the intermittent red light signals when displayed by the sign shown in diagram 3014; and
- (g) the light signals prescribed by regulation 37 and shown in diagrams 6031.1 and 6032.1 when indicating one of the prohibitions prescribed by regulation 38.

### **Signs, markings and signals to be of the size, colour and type shown in the diagrams**

**11.**—(1) Subject to the provisions of these Regulations, a sign for conveying information or a warning, requirement, restriction, prohibition or speed limit of the description specified under a diagram in Schedules 1 to 7, Part II of Schedule 10 and Schedule 12 to traffic on roads shall be of the size, colour and type shown in the diagram.

(2) The signs shown in diagrams 515.1, 515.1A, 515.2, 1012.2, 1012.3, 1049.1 and 7102 shall be of the size, colour and type shown in the two parts of those diagrams.

(3) In Schedule 6, a road marking shown in a diagram as a horizontal line indicates a marking to be laid on the carriageway of a road transversely, and a marking shown as a vertical line indicates a marking to be laid on the carriageway of a road longitudinally, to the flow of traffic, except so far as the nature of the diagram or the caption to the diagram indicates that it may or should be laid in another direction.

(4) The road markings shown in diagrams 1055.1 and 1055.2 shall be white, silver or light grey in colour.

### **Variations of dimensions**

**12.**—(1) Where any diagram in Schedules 1 to 12 specifies a dimension for an element of a sign together with a dimension for that element in brackets, the dimensions so specified shall, subject to paragraph (2), be alternatives.

(2) Subject to paragraphs (3) and (4), where alternative dimensions are specified for more than one element of a sign, the dimensions chosen for each element must correspond with one another so that the shape and proportions of the sign are, so far as reasonably practicable, as shown in the diagram.

(3) Paragraph (2) does not apply to the road marking shown in diagram 1009 and the respective lengths of the lines comprised in that sign and of the gaps between them may be either—

- (a) 600 and 300 millimetres, in which case the width of the lines may be 100, 150 or 200 millimetres; or
- (b) 300 and 150 millimetres, in which case the width of the lines shall be 100 millimetres.

(4) Paragraph (2) does not apply to the road markings shown in diagrams 1001.2, 1013.3, 1013.4, 1040, 1040.2, 1040.4, 1041 and 1041.1.

(5) Where any diagram in Schedules 1 to 12 specifies a maximum and a minimum dimension for an element of a sign, the dimension chosen for that element shall, subject to the footnote to Table 1, be not more than the maximum and not less than the minimum.

*Status: This is the original version (as it was originally made). This item of legislation is currently only available in its original format.*

(6) Where the maximum and minimum dimensions are specified for more than one element of a sign, the dimensions chosen for each element must (except in the case of diagrams 1003.4, 1028.2, 1028.3, 1028.4, 1032, 1033, 1043, 1044, 1045, 1050, 1055.1, 1055.2, 1066, 5001.1, 5001.2, 5003, 5003.1, 5005 and 5005.1) correspond with one another so that the shape and proportions of the sign are as shown in the diagram.

(7) Where a sign shown in diagram 606, 607, 609, 610, 611, 611.1, 612, 613, 614, 616, 642 or 645 is placed temporarily on a road by a constable or a person acting under the instructions (whether general or specific) of the chief officer of police for the purposes of indicating a temporary statutory provision, any dimension in the diagram for the diameter of a roundel, or for the sign may be reduced so long as any dimension shown in the diagram for the diameter of a roundel or for the measurement horizontally of the sign is at least 200 millimetres, and the height of any lettering is at least 20 millimetres.

(8) Where a sign shown in a diagram in Schedules 1 to 5 or Schedules 7 to 12 is varied in accordance with regulation 17, the shape, proportions and size of the sign shall be adjusted to the extent necessary to accommodate the variation.

(9) Any sign shown in a diagram in Part III of Schedule 12 shall be of such dimensions as, having regard to the character of the road and the speed of traffic generally using it, are necessary to accommodate the route symbols or arrows appropriate to the number of traffic lanes and the nature of the road works in relation to which the sign is placed.

(10) Any dimension (not being an angle or specified as a maximum or minimum) specified in these Regulations shall be treated as permitted by these Regulations if it is varied in accordance with the following Tables, subject, in the case of Tables 1, 2 and 3 to the Notes to those Tables.

**Table 1**

**Diagrams in Schedules 1 to 5, 7, 10 and 12—Height of letters or numbers**

<i>(1)</i> <i>Item</i>	<i>(2)</i> <i>Dimensions shown in diagrams</i>	<i>(3)</i> <i>Permitted variations</i>
1.	100 millimetres or more	Up to 5% of the dimension
2.	Less than 100 millimetres	Up to 7.5% of the dimension

NOTE: Where the height of letters or numbers is expressed as a range within maximum and minimum dimensions the permitted variations indicated in this Table shall apply to those dimensions shown as the maximum and minimum.

**Table 2**

**Diagrams in Schedule 6—All dimensions**

<i>(1)</i> <i>Item</i>	<i>(2)</i> <i>Dimensions shown in diagrams</i>	<i>(3)</i> <i>Permitted variations</i>
1.	3 metres or more	(i) Up to 15% of the dimension where the varied dimension is greater than the specified dimension; or

NOTE: Where a dimension denoting the length or width of a road marking is varied in accordance with this Table, and there is a space between two parts of the marking, the dimensions of that space may be varied as required to accommodate the variation of the length or width of the marking, provided that the character of the marking is maintained.

*Status: This is the original version (as it was originally made). This item of legislation is currently only available in its original format.*

<i>(1)</i> <i>Item</i>	<i>(2)</i> <i>Dimensions shown in diagrams</i>	<i>(3)</i> <i>Permitted variations</i>
		(ii) Up to 10% of the dimension where the varied dimension is less than the specified dimension
2.	300 millimetres or more, but less than 3 metres	(i) Up to 20% of the dimension where the varied dimension is greater than the specified dimension; or (ii) Up to 10% of the dimension where the varied dimension is less than the specified dimension
3.	50 millimetres or more but less than 300 millimetres	(i) Up to 30% of the dimension where the varied dimension is greater than the specified dimension; or (ii) Up to 10% of the dimension where the varied dimension is less than the specified dimension

NOTE: Where a dimension denoting the length or width of a road marking is varied in accordance with this Table, and there is a space between two parts of the marking, the dimensions of that space may be varied as required to accommodate the variation of the length or width of the marking, provided that the character of the marking is maintained.

**Table 3**

**Diagrams in Schedules 8 and 9**

<i>(1)</i> <i>Item</i>	<i>(2)</i> <i>Dimension shown in diagrams</i>	<i>(3)</i> <i>Permitted variation</i>
1.	200 millimetres	(i) up to 10% of the dimension where the varied dimension is greater than the specified dimension (ii) up to 2.5% of the dimension where the varied dimension is

NOTE: Where the dimensions of a signal which displays an arrow or symbol are varied in accordance with this table, the dimensions chosen for the arrow or symbol must be such as to maintain the shape and proportions shown in the diagram in which the signal is shown.

*Status: This is the original version (as it was originally made). This item of legislation is currently only available in its original format.*

<i>(1)</i> <i>Item</i>	<i>(2)</i> <i>Dimension shown in diagrams</i>	<i>(3)</i> <i>Permitted variation</i>
		less than the specified dimension

NOTE: Where the dimensions of a signal which displays an arrow or symbol are varied in accordance with this table, the dimensions chosen for the arrow or symbol must be such as to maintain the shape and proportions shown in the diagram in which the signal is shown.

**Table 4**

**All dimensions other than those in Tables 1, 2 and 3**

<i>(1)</i> <i>Item</i>	<i>(2)</i> <i>Dimensions shown in diagrams</i>	<i>(3)</i> <i>Permitted variations</i>
1.	300 millimetres or more	Up to 5% of the dimension
2.	50 millimetres or more, but less than 300 millimetres	Up to 7.5% of the dimension
3.	Less than 50 millimetres	Up to 10% of the dimension

(11) Any variation of any angle specified in any diagram in Schedule 1, 6 or 8, except diagrams 1043 and 1044, shall be treated as permitted by these Regulations if the variation does not exceed 5 degrees.

(12) Where—

- (a) overall dimensions are given for a sign shown in any diagram in the Schedules to these Regulations; and
- (b) the legend on that sign is varied in accordance with regulation 17 and with item 4 of the table appearing under or beside that diagram,

the overall dimensions or the number of lines filled by the legend, or both, may be varied so far as necessary to give effect to the variation of the legend.

**Proportions and form of letters, numerals, symbols and other characters**

**13.**—(1) Subject to paragraphs (2), (5), (6) and (9) all letters, numerals and other characters incorporated in the signs or parts of the signs shown in the diagrams in Schedules 1 to 5 and 7, Part II of Schedule 10 and Schedule 12 which have a red, blue, brown, black or green background shall have the proportions and form shown in Part I of Schedule 13.

(2) Paragraph (1) does not apply to the letters, numerals and other characters incorporated in—

- (a) the bottom panel of diagram 674;
- (b) diagrams 970, 971, 973.2, 973.3, 2401 and 2403.1;
- (c) the parts of diagrams 2505, 2505.1, 2506, 2507, 2508, 2509.1, 2510, 2511, 2512 and 2513 which indicate the availability of parking places in accordance with regulation 19(4)(c);
- (d) diagrams 2607, 2610, 2610.1 and 2610.2;
- (e) the top panels of diagrams 2919.1 and 2920.1;
- (f) the petrol price display in diagram 2919.1;
- (g) the reference to the traffic authority in diagrams 7003.1, 7006, 7006.1 and 7007.1;



- (h) the top and bottom panels of diagram 7008; and
- (i) the words “National Trust for Scotland” used in conjunction with the symbol shown in diagram T303 in Part IV of Schedule 14.

(3) Subject to paragraphs (4), (5), (6), (8) and (9) all letters, numerals and other characters incorporated in the signs or the parts of signs shown in the diagrams in Schedules 1 to 5, 7, 10 and 12 which have a white, yellow or orange background shall have the proportions and form shown in Part II of Schedule 13.

(4) Paragraph (3) does not apply to the letters, numerals and other characters incorporated in—

- (a) the bottom panel of diagram 674;
- (b) diagrams 970, 971, 973.2, 973.3, 2401 and 2403.1;
- (c) diagrams 2607, 2610, 2610.1 and 2610.2;
- (d) the top panels of diagrams 2919.1 and 2920.1;
- (e) the references to the traffic authority in diagrams 7003.1, 7006, 7006.1 and 7007.1; and
- (f) the top and bottom panels of diagram 7008.

(5) Letters and numerals used for the purpose of indicating a route number on any sign shown in a diagram in Part X of Schedule 7 (other than those incorporated in diagrams 2913, 2913.2, 2913.3, 2913.4, 2914, 2915, 2927.1, 2929 and 2929.1) shall have the proportions and form shown in Part III of Schedule 13, except—

- (a) where a route number is indicated in brackets on a sign shown in diagram 2904, 2904.1, 2906, 2908, 2908.1, 2909, 2913.1 or 2914.1; or
- (b) where a route number is shown on a green or white panel indicating a route that is not a motorway on a sign shown in diagram 2913.1 or 2914.1,

in either of which cases those letters and numerals shall have the proportions and form shown in either Part I or Part III of Schedule 13 as appropriate.

(6) Letters and numerals used for the purpose of indicating a route number on any sign shown in a diagram in Part III of Schedule 12 when used on a motorway shall have the proportions and form shown in Part IV of Schedule 13.

(7) Subject to and within the limits of any dimension specified as a maximum or minimum in—

- (a) the bottom panel of diagram 674;
- (b) diagrams 970, 971, 973.2, 973.3, 2401 and 2403.1;
- (c) the parts of diagrams 2505, 2505.1, 2506, 2507, 2508, 2509.1, 2510, 2511, 2512 and 2513 which indicate the availability of spaces in accordance with regulation 19(4)(c);
- (d) diagrams 2607, 2610, 2610.1 and 2610.2;
- (e) the top panels of diagrams 2919.1 and 2920.1;
- (f) the petrol price display in diagram 2919.1;
- (g) the references to the traffic authority in diagrams 7003.1, 7006, 7006.1 and 7007.1;
- (h) the top and bottom panels of diagram 7008; and
- (i) the words “National Trust for Scotland” used in conjunction with the symbol shown in diagram T303 in Part IV of Schedule 14,

any letters or numerals or other characters incorporated in those diagrams may have proportions and form other than the proportions and form shown in Schedule 13.

(8) Letters and numerals used on a sign in diagram 2714 or 2715 shall have the proportions and form shown in Part I of Schedule 13 where those letters and numerals are white and the proportions and form shown in Part II of Schedule 13 where they are black.

*Status: This is the original version (as it was originally made). This item of legislation is currently only available in its original format.*

(9) All letters, numerals, symbols and other characters incorporated in variable message signs shall have the general proportions and form shown in Part V of Schedule 13 where the construction or method of operation of the sign does not permit the use of letters, numerals and other characters of the proportions and form shown in Part I, II, III or IV of Schedule 13 or of symbols shown in diagrams in Schedules 1 to 5, 10 or 12.

(10) All letters, numerals and other characters incorporated in the road markings shown in the diagrams in Schedule 6 shall have the proportions and form shown in Part VI of Schedule 13.

(11) Symbols incorporated in signs for the purpose of indicating diversion routes to be followed in an emergency shall have the proportions and form shown in Part VII of Schedule 13.

(12) Symbols incorporated in signs for the purpose of indicating types of tourist destination shall have the proportions and form shown in Schedule 14.

### Signs attached to vehicles

**14.**—(1) Any sign attached to a vehicle of the description specified in column (2) of an item in the Table and in the position on that vehicle specified in column (3) of the item, when the vehicle is on a road which is subject to a maximum speed limit specified in column (4) of that item, shall be of the size, colour and type shown in a diagram specified in column (5).

**Table**

<i>(1)</i> <i>Item</i>	<i>(2)</i> <i>Description of vehicle</i>	<i>(3)</i> <i>Position on vehicle</i>	<i>(4)</i> <i>Maximum speed limit</i>	<i>(5)</i> <i>Diagrams</i>
1.	Road maintenance vehicle	On the front	30 mph or under	610, 7001, 7001.1
2.	Road maintenance vehicle	On the rear	30 mph or under	610, 7001, 7001.1, 7402, 7403, 7404
3.	Road maintenance vehicle	On the rear	More than 30 mph	7402, 7403, 7404
4.	Road maintenance vehicle immediately ahead of a vehicle displaying the sign shown in diagram 7403	On the rear	More than 30 mph	610, 7402, 7403, 7404
5.	Police vehicle	On the front or the rear	70 mph or under	829.1, 829.2, 829.3, 829.4

(2) The operating requirements for the lamps that form part of the signs shown in diagrams 7402 and 7403 are that—

- (a) the lamps shall be illuminated only when the signs are being used in accordance with the Table; and

(b) each lamp shall show an intermittent amber light at a rate of flashing of not less than 60 nor more than 90 flashes per minute, and in such a manner that the lights of one horizontal pair are always shown when the lights of the other horizontal pair are not shown.

(3) A sign attached to the rear of a vehicle used to escort traffic through road works, and indicating that the vehicle should not be overtaken, shall be of the size, colour and type shown in diagram 7029.

### SECTION 3

#### WARNING, REGULATORY AND INFORMATORY TRAFFIC SIGNS

##### Sign shown in diagram 610 and its significance

**15.**—(1) Except as provided in paragraphs (2) and (3), the requirement conveyed by the sign shown in diagram 610 shall be that vehicular traffic passing the sign must keep to the left of the sign where the arrow is pointed downwards to the left, or to the right of the sign where the arrow is pointed downwards to the right.

(2) On an occasion where a vehicle is being used for fire brigade, ambulance, bomb or explosive disposal, national blood service or police purposes and the observance of the requirement specified in paragraph (1) would be likely to hinder the use of that vehicle for one of those purposes then, instead of that requirement, the requirement conveyed by the sign in question shall be that the vehicle shall not proceed beyond that sign in such a manner or at such a time as to be likely to endanger any person.

(3) The requirement specified in paragraph (1) does not apply to a tramcar or trolley vehicle.

##### Signs shown in diagrams 601.1, 602, 611.1, 778, 778.1 and 784.1 and their significance

**16.**—(1) The requirements conveyed to vehicular traffic on roads by the sign shown in a diagram the number of which is specified in column (2) of an item in the Table are those specified in column (3) of that item.

**Table**

<i>(1)</i> <i>Item</i>	<i>(2)</i> <i>Diagram</i>	<i>(3)</i> <i>Requirements</i>
1.	601.1	(a) (a) Every vehicle shall stop before crossing the transverse line shown in diagram 1002.1 or, if that line is not clearly visible, before entering the major road in respect of which the sign shown in diagram 601.1 has been provided; and (b) no vehicle shall cross the transverse line shown in diagram 1002.1 or, if that line is not clearly visible,

---

**Status:** This is the original version (as it was originally made). This item of legislation is currently only available in its original format.

---

<i>(1)</i> <i>Item</i>	<i>(2)</i> <i>Diagram</i>	<i>(3)</i> <i>Requirements</i>
		enter the major road in respect of which the sign shown in diagram 601.1 has been provided, so as to be likely to endanger the driver of or any passenger in any other vehicle or to cause that driver to change the speed or course of his vehicle in order to avoid an accident.
2.	601.1 when used at a level crossing	<p>(a) (a) Every vehicle shall stop before crossing the transverse line shown in diagram 1002.1 or, if that line is not clearly visible, before entering the level crossing; and</p> <p>(b) no vehicle shall cross the transverse line shown in diagram 1002.1 or, if that line is not clearly visible, enter the level crossing, so as to be likely to endanger the driver of or any passenger in any railway vehicle or tramcar or to cause that driver to change the speed of his vehicle in order to avoid an accident.</p>
3.	602	No vehicle shall cross the transverse line shown in diagram 1003 nearer to the major road at the side of which that line is placed, or if that line is not clearly visible, enter that major road, so as to be likely to endanger the driver of or any passenger in any other vehicle or to cause that driver

<i>(1)</i> <i>Item</i>	<i>(2)</i> <i>Diagram</i>	<i>(3)</i> <i>Requirements</i>
4.	602 when placed in combination with 778 or 778.1	<p>to change the speed or course of his vehicle in order to avoid an accident.</p> <p>No vehicle shall cross the transverse line shown in diagram 1003 nearer to the level crossing at the side of which that line is placed, or if that line is not clearly visible, enter that level crossing, so as to be likely to endanger the driver of or any passenger in any railway vehicle or tramcar or to cause that driver to change the speed of his vehicle in order to avoid an accident.</p>
5.	611.1	<p>(a) (a) A vehicle entering the junction must give priority to vehicles coming from the right at the transverse road marking shown in diagram 1003.3 associated with the sign or, if the marking is not for the time being visible, at the junction; and</p> <p>(b) a vehicle proceeding through the junction must keep to the left of the white circle at the centre of the marking shown in diagram 1003.4, unless the size of the vehicle or the layout of the junction makes it impracticable to do so; and</p> <p>(c) no vehicle shall proceed past the marking shown in diagram 1003.4 in a manner or at a time likely—</p>

*Status: This is the original version (as it was originally made). This item of legislation is currently only available in its original format.*

<i>(1)</i> <i>Item</i>	<i>(2)</i> <i>Diagram</i>	<i>(3)</i> <i>Requirements</i>
		<ul style="list-style-type: none"> <li>(i) to endanger any person, or</li> <li>(ii) to cause the driver of another vehicle to change its speed or course in order to avoid an accident.</li> </ul>
6.	784.1	<p>No abnormal transport unit shall proceed onto or over a level crossing unless—</p> <ul style="list-style-type: none"> <li>(a) the driver of the unit has used a telephone provided at or near the crossing for the purpose of obtaining from a person, authorised in that behalf by the railway or tramway authority, permission for the unit to proceed;</li> <li>(b) that permission has been obtained before the unit proceeds; and</li> <li>(c) the unit proceeds in accordance with any terms attached to that permission.</li> </ul> <p>Sub-paragraphs (b) and (c) above shall not apply if—</p> <ul style="list-style-type: none"> <li>(i) the driver uses the telephone at the crossing and receives an indication for not less than two minutes that the telephone at the other end of the telephone line is being called, but no duly authorised person answers it, or he receives no indication at all due to a fault or malfunction of the telephone; and</li> <li>(ii) the driver then drives the unit on to the crossing with the reasonable</li> </ul>

<i>(1)</i> <i>Item</i>	<i>(2)</i> <i>Diagram</i>	<i>(3)</i> <i>Requirements</i>
		expectation of crossing it within times specified in a railway or tramway notice at the telephone as being times between which the railway vehicles or tramcars do not normally travel over that crossing.

(2) In this regulation—

“abnormal transport unit” means—

- (a) a motor vehicle or a vehicle combination—
  - (i) the overall length of which, inclusive of the load (if any) on the vehicle or the combination, exceeds 61 feet 6 inches (18.75 metres); or
  - (ii) the overall width of which, inclusive of the load (if any) on the vehicle or the combination, exceeds 9 feet 6 inches (2.9 metres); or
  - (iii) the maximum gross weight of which exceeds 44 tonnes; or
- (b) a motor vehicle, or a vehicle combination, which in either case is incapable of proceeding, or is unlikely to proceed, over an automatic level crossing at a speed exceeding 5 mph;

“driver” in relation to an abnormal transport unit, means where that unit is a single motor vehicle the driver of that vehicle and, where that unit is a vehicle combination, the driver of the only or the foremost motor vehicle forming part of that combination; and

“vehicle combination” means a combination of vehicles made up of one or more motor vehicles and one or more trailers all of which are linked together when travelling.

### **Permitted variants of upright signs**

17.—(1) This regulation applies to a sign shown in a diagram in a Schedule other than Schedule 6 and such a sign is in this regulation called an “upright sign”.

(2) The form of an upright sign shall, if the circumstances in which it is placed so require, or may, if appropriate in those circumstances, be varied—

- (a) in the manner (if any) allowed or required in item 4 of the untitled table below or beside the diagram; or
- (b) in the manner allowed or required in column (3) of an item in Schedule 16, if the diagram is one whose number is given in column (2) of that item.

(3) A symbol in the form of a prescribed sign to which direction 7 of the Traffic Signs General Directions 2002 applies shall not be incorporated in a sign in accordance with item 31 of Schedule 16, except in circumstances where it could be placed as a sign in accordance with that direction.

(4) A symbol incorporated as mentioned in paragraph (3) shall or may be varied in the same manner as the sign which the symbol represents or from which it is derived.

(5) In each of the signs shown in diagrams 780A, 780.1A and 780.2A the safe height shown on the sign shall be varied where necessary so that it is between 1 foot 3 inches and 2 feet (380 to 600 millimetres) less than the height of the lowest part of the overhead wire, of which the sign gives warning, over the highest part of the surface of the carriageway beneath that wire.

(6) Where a sign shown in a diagram in Schedule 7 indicates a road or a route, and that road or route is temporarily closed, there may be affixed to the sign or to that part of the sign where that road or route is indicated, in order to cancel temporarily the indication, a board coloured red and displaying in white lettering the words “Road temporarily closed” or “Route temporarily closed”.

(7) In this paragraph and paragraphs (8) and (9)—

- (a) “combination sign” means a sign shown in diagram 7201, 7210, 7211.1, 7212, 7213, 7214, 7215, 7216, 7217, 7218, 7220, 7221, 7230, 7231, 7232, 7233, 7234, 7235, 7236, 7237, 7238, 7239 or 7240;
- (b) “panel” means a sign shown in diagram 7260, 7261, 7262, 7263, 7264, 7270, 7271, 7272, 7274 or 7275 when used as part of a combination sign and references to a panel whose number is shown in a table of combinations are to a sign shown in a diagram having a number so shown;
- (c) “permitted combination” means one of the combinations specified in paragraph (9);
- (d) “the table” in relation to a combination sign means the table of combinations appearing below or beside the diagram in which that sign is shown;
- (e) “top panel” means a panel shown at the top of a combination sign and “bottom panel” means a panel shown at the bottom of such a sign.

(8) If and only if the top and bottom panels of the sign as varied together constitute a permitted combination, a combination sign may be varied in the following ways—

- (a) by substituting for the top panel or, where a top panel is not shown, by adding as a top panel, a panel whose number is shown in item (1) of the table;
- (b) by substituting for the bottom panel or, where a bottom panel is not shown, by adding as a bottom panel, a panel whose number is shown in item (2) of the table;
- (c) if the word “none” appears in item (1) of the table, by omitting the top panel;
- (d) if the word “none” appears in item (2) of the table, by omitting the bottom panel.

(9) Each of the following is a permitted combination—

- (a) a top panel whose number appears in item (1) of a column in the table and a bottom panel whose number appears in item (2) of the same column;
- (b) a top panel whose number appears in item (1) of a column in the table and, if the word “none” appears in item (2) of the same column, no bottom panel;
- (c) a bottom panel whose number appears in item (2) of a column in the table and, if the word “none” appears in item (1) of the same column, no top panel;
- (d) if the word “none” appears in both items of the same column of the table, no top panel and no bottom panel.

(10) Where an upright sign indicates a weight in tonnes using the symbol “T”, that symbol may be varied to “t”.

(11) Where the form of an upright sign is varied in accordance with these Regulations, the information, warning, requirement, restriction, prohibition or speed limit conveyed to traffic by the sign is varied to accord with the form of the sign as varied.

### **Illumination of signs**

**18.**—(1) Subject to paragraph (2), every sign shown in a diagram whose number is indicated in column (2) of an item in Schedule 17 shall be illuminated in the manner and at the times specified in column (3) of that item.

(2) Where a sign shown in a diagram whose number is indicated in column (2) of an item in Schedule 17 is placed for the purpose of conveying to vehicular traffic a warning, information,



prohibition, restriction or requirement which applies only at certain times, the sign need only be illuminated, and in the case of the sign shown in diagram 776 shall only be illuminated, in accordance with that Schedule at those times.

(3) Where a sign shown in a diagram whose number is indicated in column (2) of an item in Schedule 17 is illuminated by a means of external lighting, then that means of lighting—

- (a) shall be fitted to the sign or the structure on which the sign is mounted or which is otherwise specially provided; or
- (b) if the sign is mounted on a bridge, tunnel or similar structure over a road or is provided temporarily at road works, the means of lighting may be mounted in any other manner such as to illuminate the face of the sign effectively.

### **Illumination of signs—further provisions**

**19.**—(1) Nothing in this regulation shall apply to the signs shown in diagrams 560, 561, 776 and 781.

(2) Subject to the provisions of regulation 18 and paragraph (1), any sign shown in a diagram in Schedules 1 to 5 and 7, Part II of Schedule 10 and Schedule 12—

- (a) when placed in consequence of the execution of road works must, and
- (b) in other situations may,

be reflectorised in accordance with the following provisions of this regulation.

(3) Subject to paragraph (4), where retroreflecting material is used on any part of a sign shown in a diagram, all other parts of that sign shall also be reflectorised.

(4) No retroreflecting material shall be applied to—

- (a) any part of a sign coloured black;
- (b) that part of the sign shown in diagram 7031 which is coloured fluorescent yellow, unless the retroreflecting material is applied to that part in horizontal strips with a gap between each strip, or unless the retroreflecting material is itself also fluorescent;
- (c) those parts of the signs shown in diagrams 2505, 2505.1, 2506, 2507, 2508, 2509.1, 2510, 2511, 2512, and 2513 which give information about the availability of parking places when that information is conveyed by means of a legend which is internally illuminated or formed of light-emitting characters,

and in this paragraph the word “part”, in relation to a sign, means any part of that sign which is uniformly coloured and bounded by parts of a different colour.

### **Illumination of plates**

**20.**—(1) Where a plate is placed in combination with a sign shown in a diagram in Schedules 1 to 5 or 12, and that sign is illuminated in accordance with regulation 18, the plate shall, subject to paragraph (2), be illuminated by the same means as the sign.

(2) Paragraph (1) shall not apply where the means of lighting provided for the illumination of the sign adequately illuminates the plate.

### **Illumination of signs shown in diagrams 560 and 561**

**21.**—(1) The signs shown in diagrams 560 and 561 shall not be illuminated by the fitting of a means of internal or external lighting.

(2) A sign shown in a diagram whose number appears in column (2) of an item in the Table and having the dimension specified in column (3) of that item shall be illuminated by either of the

*Status: This is the original version (as it was originally made). This item of legislation is currently only available in its original format.*

methods prescribed by paragraph (3) which are shown in column (4) of the item, and by no other method.

**Table**

<i>(1)</i> <i>Item</i>	<i>(2)</i> <i>Diagram</i>	<i>(3)</i> <i>Dimension</i>	<i>(4)</i> <i>Method of illumination</i>
1.	560	150 millimetres diameter	Paragraph 3(a) or (b)
2.	560	75 millimetres or more but less than 150 millimetres diameter	Paragraph 3(c) or (d)
3.	561	180 square centimetres area	Paragraph 3(b) or (e)
4.	561	not less than 45 square centimetres but not more than 180 square centimetres area	Paragraph 3(d) or (e)

(3) The prescribed methods of illumination are—

- (a) the use of 14 circular reflectors of the corner cube type, each reflector having a diameter of 22 millimetres;
- (b) the use of retroreflecting material extending over the whole surface of the sign;
- (c) the use of a single circular reflector of the corner cube type extending over the whole surface of the sign;
- (d) the use of reflectors consisting of bi-convex lenses extending over the whole surface of the sign; and
- (e) the use of a single rectangular reflector of the corner cube type extending over the whole surface of the sign.

## **Buses**

**22.**—(1) In the signs shown in—

- (a) the permitted variants of diagrams 618.1, 618.2, 618.3, 618.3A, 620 and 820;
- (b) diagrams 877, 953.3, 954, 954.2, 954.3, 954.5, 954.6, 954.7, 970, 973.2, 973.3, 974, 975, 1025.1, 1025.3 and 1025.4;
- (c) the permitted variants of diagram 1028.3; and
- (d) diagrams 1048, 1048.1, 1048.2, 1048.3 and 1048.4,

the expressions “bus” and “buses” have the meanings given in paragraph (2).

(2) “Buses” in the signs referred to in paragraph (1) means—

- (a) motor vehicles constructed or adapted to carry more than 8 passengers (exclusive of the driver); and
- (b) local buses not so constructed or adapted;

and “bus” shall be construed accordingly.

### **Bus lanes**

23.—(1) In the signs shown in the permitted variants of diagrams 877 and 878 in which the expression “bus lane” appears and in diagrams 962, 962.2, 963, 963.2, 964, 1048 and 1048.1, “bus lane” has the meaning given in paragraph (2).

- (2) “Bus lane” in the signs referred to in paragraph (1) means a traffic lane reserved for—
- (a) motor vehicles constructed or adapted to carry more than 8 passengers (exclusive of the driver);
  - (b) local buses not so constructed or adapted; and
  - (c) pedal cycles and taxis where indicated on the sign shown in diagram 958 or 959 and pedal cycles where indicated on the sign shown in diagram 960, 962.2, 963.2 or 1048.1.

### **Bus symbols**

24.—(1) A bus symbol when incorporated into any sign refers to—

- (a) motor vehicles constructed or adapted to carry more than 8 passengers (exclusive of the driver); or
- (b) local buses not so constructed or adapted.

(2) In the signs shown in diagrams 958 and 959 and in the permitted variants of diagrams 953, 953.1 and 960, the word “local” on a bus symbol indicates that the road or the traffic lane on or near which the sign has been placed shall be used only by local buses.

(3) In this regulation “bus symbol” means a symbol depicting a bus in the form shown in diagram 952, 953 or 962.2.

## *SECTION 4*

### *ROAD MARKINGS*

#### **Road marking shown in diagram 1003: give way**

25.—(1) The requirements conveyed to vehicular traffic on roads by the road marking consisting of the transverse lines shown in diagram 1003 shall be as follows.

(2) Except as provided by paragraphs (3) to (6), the requirement conveyed by the transverse lines shown in diagram 1003, whether or not they are placed in conjunction with the sign shown in diagram 602 or 1023, shall be that no vehicle shall proceed past such one of those lines as is nearer the major road into that road in a manner or at a time likely to endanger the driver of or any passenger in a vehicle on the major road or to cause the driver of such a vehicle to change its speed or course in order to avoid an accident.

(3) Wherever the transverse lines are placed in conjunction with the sign shown in diagram 602, and that sign is at the same time placed in combination with the sign shown in diagram 778 or 778.1 at a level crossing, then the requirement shall be that no vehicle shall proceed past such one of those lines as is nearer the level crossing in a manner or at a time likely to endanger the driver of or any passenger in a railway vehicle or tramcar, or to cause that driver to change the speed of his vehicle in order to avoid an accident.

(4) Wherever the transverse lines are placed in advance of a point in the road where the width of the carriageway narrows significantly, then the requirement shall be that no vehicle shall proceed past such one of those lines as is nearer to the point of narrowing in a manner or at a time likely to endanger the driver of or any passenger in a vehicle that is proceeding in the opposite direction to the first-mentioned vehicle, or to cause the driver of such a vehicle to change its speed or course in order to avoid an accident.

(5) Where the transverse lines are placed in conjunction with the sign shown in diagram 611.1 at a junction marked with the road marking shown in diagram 1003.4, then the requirement shall be that no vehicle shall proceed past such one of those lines as is nearer to the road marking shown in diagram 1003.4 in a manner or at a time likely to endanger the driver of or any passenger in a vehicle circulating past that road marking from the right of the first-mentioned vehicle or to cause the driver of the second-mentioned vehicle to change its speed or course in order to avoid an accident.

(6) Where the transverse lines are placed in advance of a length of the carriageway of the road where a cycle track crosses the road along a route parallel to the transverse lines, then the requirement shall be that no vehicle shall proceed past such one of those lines as is nearer the cycle track, in a manner or at a time likely to endanger any cyclist proceeding along the cycle track or to cause such a cyclist to change speed or course in order to avoid an accident.

### **Road markings shown in diagrams 1013.1, 1013.3 and 1013.4: double white lines**

**26.**—(1) A road marking for conveying the requirements specified in paragraph (2) and the warning specified in paragraph (7) shall be of the size, colour and type shown in diagram 1013.1, 1013.3 or 1013.4.

(2) The requirements conveyed by a road marking mentioned in paragraph (1) shall be that—

- (a) subject to paragraphs (3) and (5), no vehicle shall stop on any length of road along which the marking has been placed at any point between the ends of the marking; and
- (b) subject to paragraph (6), every vehicle proceeding on any length of road along which the marking has been so placed that, as viewed in the direction of travel of the vehicle, a continuous line is on the left of a broken line or of another continuous line, shall be so driven as to keep the first-mentioned continuous line on the right hand or off side of the vehicle.

(3) Nothing in paragraph (2)(a) shall apply so as to prevent a vehicle stopping on any length of road so long as may be necessary for any of the purposes specified in paragraph (4) if the vehicle cannot be used for such a purpose without stopping on the length of road.

(4) The purposes are—

- (a) to enable a person to board or alight from the vehicle,
- (b) to enable goods to be loaded on to or to be unloaded from the vehicle,
- (c) to enable the vehicle to be used in connection with—
  - (i) any operation involving building, demolition or excavation;
  - (ii) the removal of any obstruction to traffic;
  - (iii) the maintenance, improvement or reconstruction of the length of road; or
  - (iv) the laying, erection, alteration, repair or cleaning in or near the length of road of any sewer or of any main, pipe or apparatus for the supply of gas, water or electricity, or of any telecommunications apparatus kept installed for the purposes of a telecommunications code system or of any other telecommunications apparatus lawfully kept installed in any position.

(5) Nothing in paragraph (2)(a) shall apply—

- (a) so as to prevent a vehicle stopping in a lay-by;
- (b) to a vehicle for the time being used for fire brigade, ambulance or police purposes;
- (c) to a pedal bicycle not having a sidecar attached thereto, whether additional means of propulsion by mechanical power are attached to the bicycle or not;

- (d) to a vehicle stopping in any case where the person in control of the vehicle is required by law to stop, or is obliged to do so in order to avoid an accident, or is prevented from proceeding by circumstances outside his control;
  - (e) to anything done with the permission or at the direction of a constable in uniform or in accordance with the direction of a traffic warden; or
  - (f) to a vehicle on a road with more than one traffic lane in each direction.
- (6) Nothing in paragraph (2)(b) shall be taken to prohibit a vehicle from being driven across, or so as to straddle, the continuous line referred to in that paragraph, if it is safe to do so and if necessary to do so—
- (a) to enable the vehicle to enter, from the side of the road on which it is proceeding, land or premises adjacent to the length of road on which the line is placed, or another road joining that road;
  - (b) in order to pass a stationary vehicle;
  - (c) owing to circumstances outside the control of the driver;
  - (d) in order to avoid an accident;
  - (e) in order to pass a road maintenance vehicle which is in use, is moving at a speed not exceeding 10 mph, and is displaying to the rear the sign shown in diagram 610 or 7403;
  - (f) in order to pass a pedal cycle moving at a speed not exceeding 10 mph;
  - (g) in order to pass a horse that is being ridden or led at a speed not exceeding 10 mph; or
  - (h) for the purposes of complying with any direction of a constable in uniform or a traffic warden.
- (7) The warning conveyed by a road marking mentioned in paragraph (1) shall be that no vehicle while travelling next to a broken line placed on the left of a continuous line, as viewed in the direction of travel of the vehicle, should cross or straddle the first-mentioned line unless it is seen by the driver of the vehicle to be safe to do so.

### **Road marking shown in diagram 1001.3: zig-zag lines—no stopping**

- 27.—(1) In this regulation and regulation 28—
- “controlled area” means a length of carriageway—
- (a) which is adjacent to a signal-controlled crossing facility and has a zig-zag line marked along each of its edges (with or without zig-zag lines also marked down its centre); and
  - (b) in or near which no other signs or markings have been placed except ones comprised in the combination of signs and markings indicating the presence of the facility or shown in diagram 610, 611, 612, 613, 616, 810, 1029 or 1062;
- “local service” does not include an excursion or tour as defined by section 137(1) of the Transport Act 1985; and
- “vehicle” does not include a pedal bicycle not having a sidecar attached to it, whether or not additional means of propulsion by mechanical power are attached to the bicycle.
- (2) Subject to paragraphs (3) and (4) and without prejudice to regulation 28, a zig-zag line shall convey the requirement that the driver of a vehicle shall not cause any part of it to stop in the controlled area in which it is marked.
- (3) Paragraph (2) does not prohibit the driver of a vehicle from stopping it in a controlled area—
- (a) if the driver has stopped it for the purpose of complying with an indication given by a light signal for the control of vehicular traffic or the direction of a constable in uniform or a traffic warden;

- (b) if the driver is prevented from proceeding by circumstances beyond his control or it is necessary for him to stop to avoid injury or damage to persons or property; or
  - (c) when the vehicle is being used for police, fire brigade or ambulance purposes.
- (4) Paragraph (2) does not prohibit the driver of a vehicle from stopping it in a controlled area—
- (a) for so long as may be necessary to enable the vehicle to be used for the purposes of—
    - (i) any operation involving building, demolition or excavation;
    - (ii) the removal of any obstruction to traffic;
    - (iii) the maintenance, improvement or reconstruction of a road; or
    - (iv) the laying, erection, alteration, repair or cleaning in or near the controlled area of any sewer or of any main, pipe or apparatus for the supply of gas, water or electricity, or of any telecommunications apparatus kept installed for the purposes of a telecommunications code system or of any other telecommunications apparatus lawfully kept installed in any position;
  - (b) in the provision of a local service, and the vehicle, having proceeded past the light signals to which the controlled area relates, is waiting in that area in order to take up or set down passengers; or
  - (c) if he stops the vehicle for the purpose of making a left or right turn.

**Road marking shown in diagram 1001.3: zig-zag lines—no overtaking**

28.—(1) Without prejudice to regulation 27, a zig-zag line shall convey the requirement that, whilst any motor vehicle (in this regulation called “the approaching vehicle”) or any part of it is within the limits of a controlled area and is proceeding towards the signal-controlled crossing facility to which the controlled area relates, the driver of the vehicle shall not cause it or any part of it—

- (a) to pass ahead of the foremost part of any other motor vehicle proceeding in the same direction; or
  - (b) to pass ahead of the foremost part of a vehicle which is stationary for the purpose of complying with the indication given by a traffic light signal for controlling vehicular traffic.
- (2) In paragraph (1)—
- (a) the reference to a motor vehicle in sub-paragraph (a) is, in a case where more than one motor vehicle is proceeding in the same direction as the approaching vehicle in a controlled area, a reference to the motor vehicle nearest to the signal-controlled crossing facility to which the controlled area relates; and
  - (b) the reference to a stationary vehicle is, in a case where more than one vehicle is stationary in a controlled area for the purpose of complying with the indication given by a traffic light signal for controlling vehicular traffic, a reference to the stationary vehicle nearest the signal-controlled crossing facility to which the controlled area relates.

**Road markings shown in diagrams 1025.1, 1025.3, 1025.4, 1043 and 1044: bus stop and bus stand clearways and box junctions**

29.—(1) The road markings shown in diagrams 1025.1, 1025.3 and 1025.4 shall convey the prohibition specified in Part I of Schedule 19.

(2) The road markings shown in diagrams 1043 and 1044 shall convey the prohibition specified in Part II of Schedule 19.

### Permitted variants of road markings

**30.**—(1) Where the circumstances in which a road marking shown in a diagram in Schedule 6 is to be placed so require or where appropriate in those circumstances, the form of the marking shall or may be varied as follows—

- (a) in the manner (if any) allowed or required in item 4 of the untitled table below or beside the diagram; or
- (b) in the manner allowed or required in column (3) of an item in Schedule 16, if the diagram is one whose number is given in column (2) of that item.

(2) In the road marking shown in diagram 1035, route numbers, place names and the direction in which any arrow-head points shall be varied to accord with the circumstances but the words “turn left”, “ahead” or “turn right” shall not be included in the marking.

(3) Where the form of a road marking is varied in accordance with this regulation, the information, warning, requirement, restriction, prohibition or speed limit conveyed by the marking is varied to accord with the form of marking as varied.

### Illumination of road markings

**31.**—(1) Subject to paragraph (2) a road marking shown in diagram 1001 (except when used in conjunction with the road marking shown in diagram 1001.3), 1001.1, 1001.2, 1002.1, 1003, 1003.1, 1003.3, 1003.4, 1004, 1004.1, 1005, 1005.1, 1008, 1008.1, 1009, 1010, 1012.1, 1012.2, 1012.3, 1013.1, 1013.3, 1013.4, 1014, 1022, 1023, 1024, 1024.1, 1036.1, 1036.2, 1037.1, 1039, 1040, 1040.2, 1040.3, 1040.4, 1040.5, 1041, 1041.1, 1042, 1042.1, 1046, 1049, 1062, 1064 or 1065 shall be reflectorised.

(2) Paragraph (1) shall not apply to a road marking shown in diagram 1003, 1023 or 1049 when varied for use on a cycle track.

(3) Subject to paragraph (4), studs incorporating reflectors or retroreflecting material and so spaced as to form a single line of studs not less than 3 nor more than 4.5 metres apart shall be fitted—

- (a) between the two lines constituting the marking shown in diagram 1013.1, except where that marking is so placed that the continuous lines shown in version B of diagram 1013.1 are more than 175 millimetres apart and are separated by an area of cross-hatching so shown;
- (b) between the two continuous parallel lines forming part of the marking shown in diagrams 1013.3 and 1013.4.

(4) Where the marking shown in diagram 1013.1 is placed as mentioned in the exception to paragraph (3)(a), the studs mentioned in paragraph (3) shall be fitted either in opposite pairs within the width of each of the two lines or in a single line between those lines.

(5) Subject to the foregoing provisions of this regulation, and to paragraph (6), any road marking may be reflectorised, and studs incorporating reflectors or retroreflecting material may be used with a road marking shown in diagram 1004, 1004.1, 1005, 1005.1, 1008, 1008.1, 1010, 1012.1, 1012.2, 1012.3, 1025.3, 1025.4, 1035, 1040, 1040.2, 1040.3, 1040.4, 1040.5, 1041, 1041.1, 1042 or 1042.1 in such a manner that any such stud shall not be fitted to any part of the marking coloured white or yellow but shall be applied to the surface of the carriageway in the gaps between parts of a broken line, or alongside a solid line, forming part of the marking.

(6) In the case of a road marking shown in diagram 1012.1, 1012.2, 1012.3, 1042 or 1042.1 the studs shall, if fitted, be applied to the surface of the carriageway at the side of and adjacent to the line shown in the diagram.

(7) Reflectors or retroreflecting material incorporated in studs shall be white except that in the case of studs used with a road marking shown in diagram 1010, 1012.1, 1012.2, 1012.3, 1025.3,

1025.4, 1040.3, 1040.4, 1040.5, 1041, 1041.1, 1042 or 1042.1 the reflectors or retroreflecting material shall reflect—

- (a) red light where the near side edge of a carriageway is indicated to drivers of approaching vehicles, or when placed in conjunction with the markings shown in diagrams 1041, 1041.1, 1042 and 1042.1 to indicate the off side edge of a carriageway;
- (b) amber light to indicate the off side edge of a carriageway which—
  - (i) is contiguous to a central reservation or to traffic cones or cylinders at road works or to the road marking shown in diagram 1040.3; or
  - (ii) carries traffic in one direction only; and
- (c) green light when placed in conjunction with a road marking shown in diagram 1010, 1025.3 or 1025.4 where the edge of any part of the carriageway available for through traffic at a junction, a lay-by or a parking place is so indicated to drivers of approaching vehicles.

(8) The colour of the parts of the stud other than the reflectors or retroreflecting material shall either be the same as the reflectors or retroreflecting material, or be white, or be a natural metallic finish or other neutral colour, or shall be fluorescent green/yellow in the case of studs placed temporarily at road works.

### **Height of road markings and size of studs**

**32.—**(1) The size and shape of a stud incorporating reflectors or retroreflecting material shall be such that the part which is visible above the surface of the road can be contained within—

- (a) an overall length in the direction of travel of traffic of not less than 35 millimetres and not exceeding 250 millimetres; and
- (b) an overall width of not less than 84 millimetres and not exceeding 190 millimetres.

(2) No road marking or stud shall project above the surface of the adjacent carriageway more than 6 millimetres at any point except—

- (a) a depressible stud, which shall not project above that surface more than 25 millimetres at its highest point, whether depressed or not;
- (b) a non-depressible stud, which shall not project above that surface more than 20 millimetres at its highest point;
- (c) the central circular part of the road marking shown in diagram 1003.4, which shall not project above that surface more than 125 millimetres at its highest point or 6 millimetres at its perimeter;
- (d) the road marking shown in diagram 1012.2, the raised ribs on which shall project above the surface of the remainder of the marking by not more than 11 millimetres; or
- (e) the road marking shown in diagram 1012.3, the raised ribs on which shall project above the surface of the remainder of the marking by not more than 8 millimetres; and
- (f) the road marking shown in diagram 1049.1, the height of which above the surface of the adjacent carriageway shall be within the range of dimensions indicated on the second part of that diagram illustrating the cross-section of the marking.

(3) In this regulation, the expression “depressible stud” means a stud so fitted that the height by which it, or part of it, projects above the surface of the adjacent carriageway is apt to be reduced when pressure is applied to the stud from above; and “non-depressible stud” and “depressed” shall be construed accordingly.



## SECTION 5

## LIGHT SIGNALS AND WARNING LIGHTS

**Light signals for the control of vehicular traffic—standard form**

33.—(1) Subject to regulation 34, light signals for the control of vehicular traffic (other than tramcars) at junctions, at places where the headroom or the width of the road is permanently restricted, or at signal-controlled crossing facilities—

- (a) shall be of the size, colour and type shown in diagram 3000, 3000.7, 3000.8, 3000.9 or 3000.10;
- (b) shall be illuminated in the sequence prescribed by paragraph (3); and
- (c) shall have ES compliant signal heads.

(2) Light signals for the control of vehicular traffic consisting exclusively of pedal cycles—

- (a) shall be of the size, colour and type shown in diagram 3000.2;
- (b) shall be illuminated in the sequence prescribed by paragraph (3); and
- (c) shall have ES compliant signal heads.

(3) The sequence of illumination of the lights shown by the signals prescribed by paragraphs (1) and (2) shall be as follows—

- (a) red,
- (b) red and amber together,
- (c) green,
- (d) amber.

(4) Where the light signals are varied as prescribed by regulation 34, one or more green arrows shown in diagram 3001.2 or 3001.3 may be illuminated whilst any of the lights referred to in paragraph (3) are illuminated.

(5) For the purposes of these Regulations a signal head is “ES compliant” if, in relation to each aspect of its performance specified in column (2) of an item in the Table, it complies with the requirement or test specification of European Standard EN12368: 2000 specified in column (3) of the item or to an equivalent requirement or test specification specified in a corresponding EEA standard.

**Table**

<i>(1)</i> <i>Item</i>	<i>(2)</i> <i>Aspect of performance</i>	<i>(3)</i> <i>Requirement or test specification and class</i>
1.	Protection rating	Class IV: IP 55
2.	Operating temperature range	Class A
3.	Luminous intensity	Performance level 3, class 2
4.	Distribution of luminous intensity	Type M
5.	Maximum signal phantom	Class 5
6.	Signal lights incorporating symbols	Class S1
7.	Background screen	Class C1

---

*Status: This is the original version (as it was originally made). This item of legislation is currently only available in its original format.*

---

<i>(1)</i> <i>Item</i>	<i>(2)</i> <i>Aspect of performance</i>	<i>(3)</i> <i>Requirement or test specification and class</i>
8.	Impact resistance	Class IR2

### **Green arrow light signals for the control of vehicular traffic**

**34.**—(1) A lens or lenses of the size and colour shown in diagram 3001.2 or 3001.3 which, when illuminated, shows a green arrow—

- (a) may be substituted for the lens showing the green light in the light signals referred to in regulation 33(1) using any of the methods shown in diagram 3000.8 or 3000.10; or
- (b) may be affixed to the light signals referred to in regulation 33(1) or to those signals as altered in accordance with sub-paragraph (a) using any of the methods shown in diagrams 3000.7, 3000.8, 3000.9 and 3000.10.

(2) The direction of the arrow shown in indication B in diagram 3001.2 or 3001.3 may be varied so that the head of the arrow points to any position lying between indication A and indication C.

(3) The direction of the arrow shown in indication D in diagram 3001.2 or 3001.3 may be varied so that the head of the arrow points to any position lying between indication C and indication E.

### **Portable light signals for the control of vehicular traffic**

**35.** Portable light signals for the control of vehicular traffic other than tramcars shall be—

- (a) of the size, colour and type shown in diagram 3000.1;
- (b) illuminated in the sequence prescribed by regulation 33(3); and
- (c) so constructed that, if European Standard EN12368: 2000 applied to portable signals, they would be ES compliant.

### **Significance of light signals prescribed by regulations 33 to 35**

**36.**—(1) The significance of the light signals prescribed by regulations 33, 34 and 35 shall be as follows—

- (a) subject to sub-paragraph (b) and, where the red signal is shown at the same time as the green arrow signal, to sub-paragraphs (f) and (g), the red signal shall convey the prohibition that vehicular traffic shall not proceed beyond the stop line;
- (b) when a vehicle is being used for fire brigade, ambulance, bomb or explosive disposal, national blood service or police purposes and the observance of the prohibition conveyed by the red signal in accordance with sub-paragraph (a) would be likely to hinder the use of that vehicle for the purpose for which it is being used, then sub-paragraph (a) shall not apply to the vehicle, and the red signal shall convey the prohibition that that vehicle shall not proceed beyond the stop line in a manner or at a time likely to endanger any person or to cause the driver of any vehicle proceeding in accordance with the indications of light signals operating in association with the signals displaying the red signal to change its speed or course in order to avoid an accident;
- (c) the red-with-amber signal shall, subject in a case where it is displayed at the same time as the green arrow signal to sub-paragraph (f), denote an impending change to green or a green arrow in the indication given by the signals but shall convey the same prohibition as the red signal;
- (d) the green signal shall indicate that vehicular traffic may proceed beyond the stop line and proceed straight on or to the left or to the right;

- (e) the amber signal shall, when shown alone, convey the same prohibition as the red signal, except that, as respects any vehicle which is so close to the stop line that it cannot safely be stopped without proceeding beyond the stop line, it shall convey the same indication as the green signal or green arrow signal which was shown immediately before it;
  - (f) save as provided in sub-paragraphs (g) and (h), the green arrow signal shall indicate that vehicular traffic may, notwithstanding any other indication given by the signals, proceed beyond the stop line only in the direction indicated by the arrow for the purpose of proceeding in that direction through the junction controlled by those signals;
  - (g) where more than one green arrow is affixed to light signals in accordance with regulation 34(1)(b), vehicular traffic, notwithstanding any other indication given by the signals, may proceed beyond the stop line only in the direction indicated by any one of the green arrows for the purpose of proceeding in that direction through the junction controlled by those signals; and
  - (h) where the green arrow signal is displayed at the same time as the green signal, vehicular traffic may proceed in the direction indicated by the green arrow in accordance with sub-paragraph (g) or in any other direction in accordance with sub-paragraph (d).
- (2) Vehicular traffic proceeding beyond a stop line in accordance with paragraph (1) shall proceed with due regard to the safety of other road users and subject to any direction given by a constable in uniform or a traffic warden or to any other applicable prohibition or restriction.
- (3) In this regulation the expressions “vehicle” and “vehicular traffic” do not include tramcars.

#### **Light signals for the control of vehicular traffic on motorways and all-purpose dual carriageway roads**

37.—(1) Subject to paragraph (4), light signals for the control of vehicular traffic entering or proceeding along a motorway, shall be—

- (a) of the size, colour and type shown in diagram 6031.1 or 6032.1; and
  - (b) operated in accordance with the requirements specified in paragraph (2).
- (2) The requirements are that—
- (a) each lamp shall show an intermittent red light at a rate of flashing of not less than 60 nor more than 90 flashes per minute, and in such a manner that the lights of one vertical pair are always shown when the lights of the other vertical pair are not shown; and
  - (b) the red cross or the white symbol shown in diagram 6031.1 or 6032.1 shall be illuminated by a steady light when the red lights are flashing.
- (3) Light signals for the control of vehicular traffic entering or proceeding along an all-purpose dual carriageway road may also be the size, colour and type prescribed by paragraph (1) and operated in accordance with the requirements specified in paragraph (2).
- (4) Light signals for the control of vehicular traffic—
- (a) entering a motorway by means of a slip road; or
  - (b) entering a motorway which is a roundabout may, instead of complying with paragraphs (1) and (2), be of the size, colour and type prescribed by regulation 33 or 34.

#### **Significance of light signals prescribed by regulation 37(1)**

38. The significance of the light signals prescribed by regulation 37(1) shall be as follows—
- (a) when placed beside the carriageway of a road, they shall convey the prohibition that vehicular traffic on that carriageway (other than vehicles being used in the circumstances described in regulation 36(1)(b)) shall not proceed beyond the signals; and

- (b) when displayed on a gantry over the carriageway, they shall convey the prohibition that vehicular traffic (other than vehicles being used in the circumstances described in regulation 36(1)(b)) proceeding in the traffic lane immediately below the signals shall not proceed beyond them in that lane,

and for the purposes of this regulation light signals which are mounted on a post situated beside the carriageway but which are projected over it or part of it shall be treated as light signals placed beside the carriageway of that road.

### **Light signals to control traffic at level crossings etc**

**39.**—(1) Light signals for the control of traffic at level crossings, swinging or lifting bridges, tunnels, airfields or in the vicinity of premises used regularly by fire, police or ambulance service vehicles shall—

- (a) be of the size, colour and type shown in diagram 3014;
- (b) be illuminated in the sequence prescribed by paragraph (2); and
- (c) have ES compliant signal heads.

(2) The sequence for the illumination of the light signals prescribed by paragraph (1) shall be as follows—

- (a) a single steady amber light,
- (b) two intermittent red lights, each of which will be shown at a rate of flashing of not less than 60 nor more than 90 flashes per minute, and in a such a manner that one light is always shown when the other light is not shown.

### **Significance of light signals prescribed by regulation 39**

**40.** The significance of the light signals prescribed by regulation 39 shall be as follows—

- (a) the amber signal shall convey the prohibition that traffic shall not proceed beyond the stop line or the road marking shown in diagram 1003.2, except that a vehicle which is so close to the stop line that it cannot safely be stopped without proceeding beyond the stop line may proceed across the level crossing; and
- (b) the intermittent red signals shall convey the prohibition that traffic shall not proceed beyond the stop line or the road marking shown in diagram 1003.2.

### **Light signals for the control of tramcars**

**41.**—(1) Light signals for the control of tramcars shall—

- (a) be of the size, colour and type shown in diagram 3013; and
- (b) display the aspects shown in diagrams 3013.1, 3013.2, 3013.3, 3013.4 and 3013.5 in the sequence prescribed by paragraph (2).

(2) The sequence for the illumination of the light signals prescribed by paragraph (1) shall be as follows—

- (a) the horizontal line shown in diagram 3013.1,
- (b) the vertical line shown in diagram 3013.2 or either of the diagonal lines shown in diagram 3013.3 or 3013.4,
- (c) the central circle shown in diagram 3013.5.

(3) When the light signals prescribed by paragraph (1) (“tram signals”) are affixed to the light signals mentioned in regulation 33 (“standard signals”) in accordance with any of the options shown in diagrams 3000.7, 3000.8, 3000.9 and 3000.10 their aspect may be such that they convey to the

driver of a tramcar a different significance from that conveyed at the same time in accordance with regulation 36 to the drivers of other vehicular traffic by the aspect of the standard signals to which the tram signals are affixed.

#### **Significance of light signals prescribed by regulation 41**

**42.** The significance of the light signals prescribed by regulation 41 shall be as follows—

- (a) the aspect shown in diagram 3013.1 shall convey the prohibition that a tramcar shall not proceed beyond the stop line;
- (b) the aspect shown in diagram 3013.2 shall indicate that a tramcar may proceed beyond the stop line and proceed straight ahead;
- (c) the aspect shown in diagram 3013.3 shall indicate that a tramcar may proceed beyond the stop line and proceed to the left;
- (d) the aspect shown in diagram 3013.4 shall indicate that a tramcar may proceed beyond the stop line and proceed to the right; and
- (e) the aspect shown in diagram 3013.5 shall convey the prohibition that a tramcar shall not proceed beyond the stop line except that, as respects a tramcar which is so close to the stop line that it cannot safely be stopped without proceeding beyond the stop line, it shall convey the same indication as the aspect which was shown immediately before it.

#### **Meaning of stop line and references to light signals**

**43.—**(1) Subject to paragraphs (2) and (3), “stop line” in relation to light signals for the control of vehicular traffic means—

- (a) in relation to any vehicle except a tramcar the road marking shown in diagram 1001 placed in conjunction with the light signals;
- (b) in relation to a tramcar, the road marking shown in diagram 1001.1 placed in conjunction with those light signals, or when that marking has not been so placed, the marking shown in diagram 1001 so placed.

(2) Where the road marking shown in diagram 1001.2 has been placed in conjunction with light signals, “stop line” in relation to those light signals means—

- (a) the first stop line, in the case of a vehicle (other than a pedal cycle proceeding in the cycle lane) which has not proceeded beyond that line; or
- (b) the second stop line, in the case of a vehicle which has proceeded beyond the first stop line or of a pedal cycle proceeding in the cycle lane.

(3) Where no stop line has been provided in conjunction with light signals or the stop line is not visible, references in relation to those signals to the “stop line” are—

- (a) in a case where the sign shown in diagram 7011, 7011.1 or 7027 is placed in conjunction with the light signals, to be treated as references to that sign; and
- (b) in any other case, to be treated as references to the post or other structure on which the primary signals are mounted.

(4) A reference in this regulation or in regulations 33 to 42 to light signals, to the signals or to a signal of a particular colour is, where secondary signals as well as primary signals have been placed, a reference to the light signals displayed by both the primary and secondary signals or, as the case may be, by the primary signals operating without the secondary signals or by the secondary signals operating without the primary signals.

(5) In this regulation—

- (a) “primary signals” means light signals erected on or near the carriageway of a road and—

- (i) where a stop line is placed in conjunction with the signals, sited beyond that line and near one end or both ends of the line; or
- (ii) where there is no stop line, sited at either edge or both edges of the carriageway or part of the carriageway which is in use by traffic approaching and controlled by the signals;
- (b) “secondary signals” means light signals erected on or near the carriageway facing traffic approaching from the direction of the primary signals but sited beyond those signals as viewed from the direction of travel of such traffic; and
- (c) in paragraph (2)—
  - (i) “the first stop line” means the transverse white line or lines appearing below the pedal cycle symbol in the road markings shown in either version of diagram 1001.2;
  - (ii) “the second stop line” means the transverse white line appearing above the pedal cycle symbol in the road markings shown in either version of that diagram; and
  - (iii) “the cycle lane” means the lane so marked in either version of that diagram.

#### **Light signals for lane control of vehicular traffic**

**44.—(1)** A light signal placed above the carriageway and facing the direction of oncoming vehicular traffic used for the control of that traffic proceeding along the traffic lane over which those signals have been placed shall be of the size, colour and type of any diagram shown in Part I of Schedule 10.

(2) The height of the centre of each light signal from the surface of the carriageway in the immediate vicinity shall be not less than 5.5 metres nor more than 9 metres.

- (3) The signals prescribed by this regulation shall be so designed that—
- (a) the red cross shown in diagram 5003 or 5003.1 (“the red cross”) can be internally illuminated in such a manner as to show a steady red light;
  - (b) the green arrow shown in diagram 5001.1 or 5001.2 (“the downward green arrow”) can be internally illuminated in such a manner as to show a steady green light;
  - (c) the white arrow shown in diagram 5005 or 5005.1 (“the diagonal white arrow”) can be internally illuminated in such a manner as to show a steady white light; and
  - (d) whenever one of the signals referred to in sub-paragraphs (a) to (c) is illuminated neither of the other signals referred to in those sub-paragraphs shall be illuminated when placed over the same traffic lane.
- (4) The significance of the light signals prescribed by this regulation shall be as follows—
- (a) the red cross shall convey to vehicular traffic proceeding in the traffic lane above which it is displayed the prohibition that such traffic shall not proceed beyond the red cross in the traffic lane until that prohibition is cancelled by a display over that traffic lane of the downward green arrow or diagonal white arrow or by a display over that traffic lane or beside the carriageway of the traffic sign shown in diagram 5015;
  - (b) the downward green arrow shall convey to vehicular traffic proceeding in the traffic lane above which it is displayed the information that such traffic may proceed or continue to do so in the lane beneath the arrow; and
  - (c) the diagonal white arrow shall convey to vehicular traffic proceeding in the traffic lane above which it is displayed the warning that such traffic should move into the adjacent traffic lane in the direction indicated by the arrow as soon as traffic conditions permit.

### **Warning signal for motorways and all-purpose dual carriageway roads**

**45.**—(1) A traffic sign for conveying the warning specified in paragraph (2) to vehicular traffic on a motorway or an all-purpose dual carriageway road shall be a light signal of the size, colour and type shown in diagram 6023.

- (2) The warning conveyed by the light signal shall be that—
- (a) there is a hazard ahead on the motorway or all-purpose dual carriageway road; and
  - (b) drivers should drive at a speed which does not exceed 30 mph until they are certain that the hazard has been passed or removed.

(3) When the light signal prescribed by this regulation is operated, each lamp shall show an intermittent amber light at a rate of flashing of not less than 60 nor more than 90 flashes per minute and in such a manner that one light is always shown when the other light is not shown.

### **Matrix signs for motorways and all-purpose dual carriageway roads**

**46.**—(1) In this regulation “matrix sign” means a sign shown in a diagram in Part I of Schedule 11 for conveying to traffic on a motorway or an all-purpose dual carriageway road information or a warning, requirement, restriction, prohibition or speed limit—

- (a) relating to or arising out of temporary hazardous conditions on or near the motorway or dual carriageway road; and
- (b) specified in the caption to a diagram contained in Part I of that Schedule.

(2) A matrix sign shall be a light signal and shall be of the size, colour and type prescribed by this regulation and shown in a diagram in Part I of Schedule 11.

(3) Where a matrix sign is placed beside the carriageway of a road the warning, requirement, restriction, prohibition or speed limit conveyed by the sign shall apply to all vehicular traffic facing that sign and proceeding along the carriageway beside which the sign is placed.

(4) For the purposes of this regulation a sign which is mounted on a post situated beside the carriageway but is projected over it or part of it shall be treated as a sign placed beside the carriageway of that road.

(5) Where a matrix sign mounted on a gantry or other structure is so placed that a traffic lane of the carriageway passes directly beneath it, the warning, requirement, restriction, prohibition or speed limit conveyed by the sign shall apply only to vehicular traffic facing that sign and proceeding along the traffic lane passing directly beneath it.

(6) A legend or symbol shown on a matrix sign shall be displayed by means of white or off-white light and except in the case of the signs shown in diagrams 6006.2, 6008.1, 6009.3 and 6012 shall be accompanied by the four lamps prescribed by paragraph (7).

- (7) The four lamps mentioned in paragraph (6)—
- (a) shall be of the size, colour and type shown in diagram 6022 when placed beside the carriageway or in diagram 6021 when mounted on a gantry or other structure over the carriageway; and
  - (b) when a matrix sign other than those shown in diagrams 6006.2, 6008.1, 6009.3 and 6012 is displayed, each lamp shall show an intermittent amber light at a rate of flashing of not less than 60 nor more than 90 flashes per minute and in such a manner that one horizontal pair of lights is always shown when the other horizontal pair of lights is not shown.

(8) The signs shown in diagrams 6006.2, 6008.1 and 6009.3 shall be accompanied by the four red lamps prescribed by regulation 37.

### **Light signals at signal-controlled pedestrian facilities**

47.—(1) In this regulation “the crossing”, in relation to a sign, means the signal-controlled pedestrian facility in relation to which the sign is placed.

(2) A sign for conveying to pedestrian traffic the warning and information specified in paragraph (4) shall—

- (a) be of the size, colour and type shown in diagram 4002.1; or
- (b) consist of either a single unit of the size, colour and type shown in diagram 4003.1 or of two units, one comprising the upper and the other the lower part of that unit placed close together,

and shall comply with the requirements of paragraph (3).

(3) The requirements are that the sign is so designed and constructed that—

- (a) the red figure in the sign (“the red signal”) can be internally illuminated by a steady light;
- (b) the green figure in the sign (“the green signal”) can be internally illuminated by a steady light;
- (c) when one signal is illuminated the other is not;
- (d) the green signal is illuminated only when there is at the same time conveyed to vehicular traffic a prohibition against entering the crossing and the prohibition is indicated by—
  - (i) the light signals prescribed by regulation 33 (whether or not varied in accordance with regulation 34) or 41; or
  - (ii) those light signals and the sign shown in diagram 606, 612, 613 or 616;
- (e) in the case of the sign shown in diagram 4003.1, a push button or other switching device is included which, whilst the red signal is illuminated, in some way indicates to pedestrians whether it has been activated; and
- (f) in the case of the sign shown in diagram 4002.1, the signal heads are ES compliant.

(4) The red signal, whilst it is illuminated, shall indicate the period during which, in the interests of safety, pedestrians should not use the crossing and the green signal, whilst it is illuminated, shall indicate the period during which pedestrians may use the crossing.

(5) Where the sign shown in diagram 4003.1 is provided at a crossing, any additional device which—

- (a) is of the size, colour and type of only the part of that sign which shows the red and green signals or of only the part which includes the push button and the legend above it;
- (b) complies with the requirements of paragraph (3) so far as they are relevant to it; and
- (c) is provided to supplement the indications given by the sign shown in diagram 4003.1,

shall give the same indication as the relevant part of the sign shown in that diagram.

(6) A push button device giving instructions to pedestrians on how to cause the green signal in the sign shown in diagram 4002.1 to become illuminated and explaining the significance of the red and green signals shall be of the size, colour and type shown in diagram 4003.

(7) The sign shown in diagram 4003 shall, whilst the word “WAIT” is illuminated, convey the same indication as the red signal.

(8) Any audible or tactile signal emitted by a device provided in conjunction with the green signal for the benefit of disabled persons shall convey to pedestrians the same indication as the green signal.



### **Light signals at equestrian crossings**

**48.**—(1) In this regulation “the crossing” in relation to a sign means the equestrian crossing in relation to which the sign is placed.

(2) A sign for conveying to equestrian traffic the warning and information specified in paragraph (4) shall—

- (a) be of the size, colour and type shown in diagram 4003.2; or
- (b) consist of either a single unit of the size, colour and type shown in diagram 4003.4 or of two units, one comprising the upper and the other the lower part of that unit placed close together,

and shall comply with the requirements of paragraph (3).

(3) The requirements are that the sign is so designed and constructed that—

- (a) the red symbol in the sign (“the red signal”) can be internally illuminated by a steady light;
- (b) the green symbol in the sign (“the green signal”) can be internally illuminated by a steady light;
- (c) when one signal is illuminated the other is not;
- (d) the green signal is illuminated only when there is at the same time conveyed to vehicular traffic a prohibition against entering the crossing and the prohibition is indicated by—
  - (i) the light signals prescribed by regulation 33 (whether or not varied in accordance with regulation 34) or 41; or
  - (ii) those light signals and the sign shown in diagram 606, 612, 613 or 616;
- (e) in the case of the sign shown in diagram 4003.4, a push button or other switching device is included which, whilst the red signal is illuminated, in some way indicates to equestrians whether it has been activated; and
- (f) in the case of the sign shown in diagram 4003.2, the signal heads are ES compliant.

(4) The red signal, whilst it is illuminated, shall indicate the period during which, in the interests of safety, equestrian traffic should not use the crossing and the green signal, whilst it is illuminated, shall indicate the time during which such traffic may use the crossing.

(5) Where the sign shown in diagram 4003.4 is provided at a crossing, any additional device which—

- (a) is of the size, colour and type of only the part of that sign which shows the red and green signals or of only the part which includes the push button and the legend above it;
- (b) complies with the requirements of paragraph (3) so far as they are relevant to it; and
- (c) is provided to supplement the indications given by the sign shown in diagram 4003.4,

shall give the same indication as the relevant part of the sign shown in that diagram.

(6) A push button device giving instructions to equestrians on how to cause the green signal in the sign shown in diagram 4003.2 to become illuminated and explaining the significance of the red and green signals shall be of the size, colour and type shown in diagram 4003.3.

(7) The sign shown in diagram 4003.3 shall, whilst the word “WAIT” is illuminated, convey the same indication as the red signal.

### **Light signals at Toucan crossings**

**49.**—(1) In this regulation “the crossing” in relation to a sign means the Toucan crossing in relation to which the sign is placed.

(2) A sign for conveying to pedestrians and pedal cyclists the warning and information specified in paragraph (4) shall—

- (a) be of the size, colour and type shown in diagram 4003.5; or
- (b) consist of either a single unit of the size, colour and type shown in diagram 4003.7 or of two units, one comprising the upper and the other the lower part of that unit placed close together,

and shall comply with the requirements of paragraph (3).

(3) The requirements are that the sign is so designed and constructed that—

- (a) the red figures in the signs shown in diagrams 4003.5 and 4003.7 and the red cycle symbol in diagram 4003.7 (“the red signal”) can be internally illuminated by a steady light;
- (b) the green figure and the green cycle symbol (“the green signal”) can be internally illuminated by a steady light;
- (c) when one signal is illuminated the other is not;
- (d) the green signal is illuminated only when there is at the same time conveyed to vehicular traffic, other than pedal cyclists wishing to use the crossing, a prohibition against entering the crossing and the prohibition is indicated by—
  - (i) the light signals prescribed by regulation 33 (whether or not varied in accordance with regulation 34) or 41; or
  - (ii) those light signals and the sign shown in diagram 606, 612, 613 or 616;
- (e) in the case of the sign shown in diagram 4003.7, a push button or other switching device is included which, whilst the red signal is illuminated, in some way indicates to pedestrians and pedal cyclists whether it has been activated; and
- (f) in the case of the sign shown in diagram 4003.5, the signal heads are ES compliant.

(4) The red signal, whilst it is illuminated, shall indicate the period during which, in the interests of safety, pedestrians and pedal cyclists should not use the crossing and the green signal, whilst it is illuminated, shall indicate the period during which pedestrians and pedal cyclists may use the crossing.

(5) Where the sign shown in diagram 4003.7 is provided at a crossing, any additional device which—

- (a) is of the size, colour and type of only the part of that sign which shows the red and green signals or of only the part which includes the push button and the legend above it;
- (b) complies with the requirements of paragraph (3) so far as they are relevant to it; and
- (c) is provided to supplement the indications given by the sign shown in diagram 4003.7,

shall give the same indication as the relevant part of the sign shown in that diagram.

(6) A push button device giving instructions to pedestrians and pedal cyclists on how to cause the green signal in the sign shown in diagram 4003.5 to become illuminated shall be of the size, colour and type shown in diagram 4003.6.

(7) The sign shown in diagram 4003.6 shall, whilst the word “WAIT” is illuminated, convey the same indication as the red signal.

(8) Any audible or tactile signal emitted by a device provided in conjunction with the green signal for the benefit of disabled pedestrians shall convey to pedestrians the same indication as the green signal.

### **Warning lights at school crossing places**

**50.** A sign for conveying a warning to vehicular traffic that a school crossing place lies ahead and is being patrolled by a school crossing patrol or is otherwise in use by such children—

- (a) shall be a light signal of the size, colour and type shown in diagram 4004, each lamp of which when operated shall show an intermittent amber light at a rate of flashing of not less than 60 nor more than 90 flashes per minute and in such a manner that one light is always shown when the other light is not shown; and
- (b) may be erected on or near part of the road in advance of a crossing place in relation to oncoming traffic.

### **Cattle crossing signs and warning lights**

**51.—**(1) A sign of the size, colour and type shown in diagram 4005 may be erected on or near a road in advance of a place in that road where cattle under the supervision of a herdsman on their way from one part of a farm to another cross the road (“a cattle crossing”) to convey to oncoming traffic the warning specified in paragraph (2).

(2) The warning conveyed by the sign shall be that—

- (a) a cattle crossing lies ahead and may be in use; and
- (b) traffic should be prepared to stop.

(3) When the sign is operated, each lamp shall show an intermittent amber light at a rate of flashing of not less than 60 nor more than 90 flashes per minute and in such a manner that one light is always shown when the other light is not shown.

### **Light signals for pedestrian traffic at level crossings**

**52.—**(1) Light signals conveying to pedestrians at level crossings the prohibition specified in paragraph (2) shall be of the size, colour and type shown in diagram 4006 and so designed that—

- (a) the red figure shown in diagram 4006 is internally illuminated by an intermittent red light which is shown at a rate of flashing of not less than 60 nor more than 90 flashes per minute;
- (b) the red figure is illuminated only when the intermittent red lights prescribed by regulation 39(2)(b) are illuminated; and
- (c) the signal heads are ES compliant.

(2) The red figure when illuminated in the manner prescribed by paragraph (1) shall convey the prohibition that pedestrians shall not proceed beyond the transverse road marking shown in diagram 1003.2 on the footway or diagram 1001 on the carriageway.

## *SECTION 6*

### *MISCELLANEOUS TRAFFIC SIGNS*

### **Temporary signs**

**53.—**(1) In this regulation “temporary sign” means a sign placed on or near a road for the purpose of conveying to traffic—

- (a) information about convenient routes to be followed on the occasion of—
  - (i) a sporting event;
  - (ii) an exhibition; or
  - (iii) any other public gathering,

- which is in each case likely to attract a large volume of traffic;
- (b) information about diversions or alternative traffic routes;
  - (c) information about the availability of new routes or destinations;
  - (d) information about changes in route numbers;
  - (e) warnings about, or information on how to avoid, any temporary hazards caused by—
    - (i) works being executed on or near a road;
    - (ii) adverse weather conditions or other natural causes;
    - (iii) the failure of street lighting or malfunction of or damage to any other apparatus, equipment or facility used in connection with the road or anything situated on or near or under it; or
    - (iv) damage to the road itself; or
  - (f) requests by the police for information in connection with road traffic accidents.
- (2) A temporary sign—
- (a) which conveys to traffic any information, warning, requirement, restriction or prohibition of a description which can be conveyed by a sign shown in a diagram in Schedules 1 to 12 (whether on its own or in conjunction or in combination with another such sign) shall be of the size, colour and type shown in that diagram;
  - (b) which does not fall within paragraph (a) (“a non-prescribed temporary sign”) shall be of such size, colour and type as is specified in paragraphs (3) to (6).
- (3) The shape of a non-prescribed temporary sign shall be—
- (a) rectangular but with the corners rounded; or
  - (b) as in sub-paragraph (a) with a rounded point at one end.
- (4) A non-prescribed temporary sign shall be of a size appropriate to the circumstances in which it is placed and may incorporate—
- (a) wording;
  - (b) numerals;
  - (c) arrows or chevrons;
  - (d) any appropriate symbol taken from any diagram in any Schedule; and
  - (e) the arms, badge or other device of a traffic authority, police authority or an organisation representative of road users.
- (5) Every letter and numeral incorporated in a non-prescribed temporary sign other than any letter incorporated in the sign in accordance with paragraph (4)(e) shall be not less than 40 nor more than 350 millimetres in height, and every arrow so incorporated shall be not less than 250 nor more than 1000 millimetres in length.
- (6) Every letter, numeral, arrow, chevron or symbol, other than a sign shown in a diagram in Schedules 1 to 5 when used as a symbol, incorporated in a non-prescribed temporary sign shall be—
- (a) black on a background of white or of yellow;
  - (b) white on a blue background;
  - (c) blue on a white background;
  - (d) if the sign conveys information or warnings of the kind mentioned in paragraph (1)(e), white on a red background, except where it is placed on a motorway when it shall be black on a yellow background; or

- (e) if the sign is a variable message sign, white, off-white or yellow on a black background or black on a yellow background, except when the sign is not in use when it shall display a plain black or grey face.

### **Flashing beacons**

**54.**—(1) A beacon—

- (a) showing an intermittent amber light and placed in combination with a temporary sign within the meaning of regulation 53 or the sign shown in diagram 562, 610, 7001, 7001.3, 7004, 7005, 7009, 7010.1, 7012, 7013, 7019, 7020, 7021, 7022, 7105, 7201, 7202 or 7207 and in compliance with the requirements in paragraph (2); or
- (b) showing an intermittent blue light and placed by a constable or a person acting under instructions (whether general or specific) of the chief officer of police in combination with a sign shown in diagram 606, 609, 610, 616, 633, 829.1, 829.2, 829.3, 829.4, 7101.1, 7102 or 7105, and in compliance with (c) and (d) of the requirements in paragraph (2),

shall convey the warning that drivers of vehicles should take special care.

(2) The requirements mentioned in paragraph (1) are—

- (a) the peak intensity of light emitted by the lens or lenses of each such beacon shall be—
  - (i) if the period between individual flashes does not exceed  $\frac{1}{4}$  of a second, not less than 100 candela on the principal axis of the relevant lens;
  - (ii) if the period between individual flashes exceeds  $\frac{1}{4}$  of a second, not less than 2000 candela on the principal axis; or
  - (iii) if the period between the cessation of a double flash and the start of the succeeding double flash exceeds  $\frac{1}{4}$  of a second, not less than 1000 candela on the principal axis;
- (b) each lens shall be of such a shape and size that the perimeter of its area projected horizontally onto a vertical plane shall be capable of lying wholly inside a square having sides of 200 millimetres in length and wholly outside a square having sides of 100 millimetres in length;
- (c) the height of the centre of the lenses from the surface of the carriageway in the immediate vicinity shall be not less than 800 (or in the case of a beacon of the kind mentioned in paragraph (1)(b) 450) nor more than 1500 millimetres; and
- (d) the rate of flashing shall be not less than 55 nor more than 150 individual or double flashes per minute.

### **Road danger lamps**

**55.**—(1) A lamp showing a steady or intermittent amber light which—

- (a) conforms to—
  - (i) British Standard Specification BS3143: Part 1: 1985 amended by Amendment No. 1 dated February 1985;
  - (ii) BS3143: Part 2: 1990 amended by Amendment No. 1 dated November 1993 and Amendment No. 2 dated December 1998; or
  - (iii) a corresponding EEA Standard; and
- (b) is illuminated separately and by a single source of light,

shall indicate to traffic the limits of a temporary obstruction of the road and in this regulation is called a “road danger lamp”.

(2) The height of the centre of each lens of a road danger lamp from the surface of the road in the immediate vicinity of the lamp shall not exceed 1500 millimetres where the speed limit on the road is 40 mph or less, or 1200 millimetres where the speed limit on the road is more than 40 mph.

- (3) The rate of flashing of a road danger lamp which shows an intermittent light shall be—
- (a) if the lamp is placed not less than 50 metres from a street lamp lit by electricity on a road subject to a speed limit of 40 mph or less, either—
    - (i) not less than 900 flashes per minute; or
    - (ii) not less than 55 nor more than 150 flashes per minute;
  - (b) in any other case not less than 900 flashes per minute.

### **Cones, delineators and cylinders**

**56.**—(1) In this regulation—

- “cone” means the sign shown in diagram 7101.1;
- “delineator” means the sign shown in diagram 7102;
- “cylinder” means the sign shown in diagram 7103.

(2) A cone shall consist of a conically shaped device made of rubber or flexible plastic material in respect of which—

- (a) the base is of any single colour; and
- (b) the base is a polygon having not more than eight sides, which would be contained wholly within a circle with a diameter of three quarters of the height of the cone.

(3) The part of a cone coloured white shall, subject to paragraph (5), be illuminated with white retroreflecting material and the part coloured red may be illuminated with red retroreflecting material.

(4) Information about the ownership of a cone may be moulded—

- (a) into the base in characters not more than 80 mm high in the same colour as the base;
- (b) into the conical body in characters not more than 40 mm high in the same colour as that body; or
- (c) as mentioned in both sub-paragraphs (a) and (b).

(5) Information about the manufacture of a cone, required to comply with British Standard Specification BS873: Part 8: 1985 or a corresponding EEA Standard and occupying an area not exceeding 30 square centimetres, may be indicated on the part coloured white in characters not exceeding 5 millimetres in height, leaving at least 90% of the remaining area of white colour illuminated with white retroreflecting material.

(6) A rotating device may be mounted on top of a cone and—

- (a) that device shall—
  - (i) be red and not reflectorised; and
  - (ii) display one or more signs shown in either diagram 560 or diagram 561; and
- (b) those signs shall be coloured amber, intermittently whilst rotating and constantly whilst static.

(7) A delineator shall consist of a flat device—

- (a) of which the side intended to be exposed to traffic is coloured as shown in diagram 7102 and the reverse side is either so coloured or coloured only grey or only red;
- (b) which is made of rubber or flexible plastic material; and

- (c) of which the base is of any single colour, except that a reflectorised white line 100 millimetres wide at an angle of not more than 60 degrees to the road surface may be marked on one side of the base at right angles to the face of the delineator.
- (8) The white part of a delineator shall, subject to paragraph (10), be illuminated with white retroreflecting material and the red part (except on the reverse side when that side is coloured only red) may be illuminated with red retroreflecting material.
- (9) Information about the ownership of a delineator may be moulded into the base in characters not more than 80 mm high and in the same colour as the base.
- (10) Information about the manufacture of a delineator, required in order to comply with British Standard Specification BS 873: Part 8: 1985 or a corresponding EEA Standard and occupying an area not exceeding 30 square centimetres, may be indicated on the part coloured white in characters not exceeding 5 millimetres in height, leaving at least 90% of the remaining area of white colour illuminated with white retroreflecting material.
- (11) A cylinder shall consist of a cylindrically shaped device made of rubber or flexible plastic material.
- (12) The white part of a cylinder shall, subject to paragraph (14), be illuminated with white retroreflecting material and the part coloured red may be illuminated with red retroreflecting material.
- (13) Information about the ownership of a cylinder may be moulded into the lower of the two red parts in red characters not more than 40 mm high.
- (14) Information about the manufacture of a cylinder, required in order to comply with British Standard Specification BS873: Part 8: 1985 or a corresponding EEA Standard and occupying an area not exceeding 30 square centimetres, may be indicated on the part coloured white in characters not exceeding 5 millimetres in height, leaving at least 90% of the remaining area of white colour illuminated with white retroreflecting material.

### **Refuge indicator lamps**

- 57.** A lamp in the form of an illuminated spherical globe for conveying the warning that drivers of vehicles are approaching a street refuge may be placed subject to the following conditions—
- (a) the globe shall be white;
  - (b) the globe shall have a diameter of not less than 275 nor more than 335 millimetres; and
  - (c) the height of the centre of the globe above the surface of the carriageway in the immediate vicinity shall be not less than 3800 millimetres nor more than 5000 millimetres.

### **Variable message signs**

- 58.**—(1) In these Regulations a “variable message sign” means a device capable of displaying, at different times, two or more aspects falling within the following descriptions—
- (a) a sign shown in a diagram in Schedule 1, 2, 3, 4, 5, 7, 11 or 12;
  - (b) a legend of a type shown in Schedule 15 in accordance with the provisions of that Schedule;
  - (c) a non-prescribed temporary sign as defined by regulation 53(2)(b);
  - (d) a blank grey or a blank black face.
- (2) A variable message sign shall be of a size appropriate to display the messages referred to in sub-paragraphs (a) and (b) of paragraph (1), having regard to the normal speed of traffic on the road on or near which the sign is situated.
- (3) If the construction or method of operation of a variable message sign prevents a sign from being displayed in the colours shown for it in the appropriate diagram in Schedule 1, 2, 3, 4, 5, 7

or 12, a black legend or symbol on a white or yellow background may be displayed as a white, off-white or yellow legend or symbol on a dark background, provided that any red triangle or red circle forming part of the sign is included.

(4) A legend or symbol as mentioned in paragraph (3) may be in the form of a white, off-white or yellow outline of the legend or symbol.

(5) The size of any symbol or legend, including any red triangle or circle, displayed on a variable message sign, which is displayed by means of light-emitting characters or symbols, may be varied so that the size of the symbol or legend appears to road users to be the same as it appears to them to be when it is not displayed in this manner.

(6) When a variable message sign displays—

- (a) the sign shown in diagram 670;
- (b) any sign shown in a diagram in Part I of Schedule 11 except diagrams 6006.2, 6008.1, 6009.3 and 6012; or
- (c) a legend of the type shown in Schedule 15,

it may also display four lamps, which are of the size, colour and type specified in regulation 46(7) and have a rate of flashing of not less than 60 nor more than 150 flashes per minute, and the distance between the lamps shall accord with the overall size of the variable message sign.

(7) Where a variable message sign displays by means of light-emitting characters or symbols—

- (a) the sign shown in diagram 504.1, 505.1, 506.1, 507.1, 510, 512, 512.1, 512.2 or 513; or
- (b) the sign shown in diagram 670 (when showing the numerals “20”, “30”, “40” or “50”) in such a way that the sign is only visible when associated equipment detects the presence of a vehicle exceeding the speed limit indicated by the sign,

the variable message sign may display, beneath the sign displayed on it, the legend “SLOW DOWN” in characters having a height not less than one quarter of the height of the displayed sign.

(8) The display of a blank black or grey face on a variable message sign accompanied by four flashing lamps of the kind mentioned in paragraph (6) shall indicate to drivers that they should take special care.

(9) A variable message sign which displays alternately the signs shown in diagrams 7023 and 7024 shall be manually operated.

Signed by authority of the Secretary of State

16th December 2002

*David Jamieson*  
Parliamentary Under Secretary of State,  
Department for Transport



**Status:** This is the original version (as it was originally made). This item of legislation is currently only available in its original format.

## SCHEDULE 1 WARNING SIGNS

### SCHEDULE 1 WARNING SIGNS

Regulation 11(1)

(other than those for railway and tramway level crossings,  
bus and pedal cycle facilities, and road works)

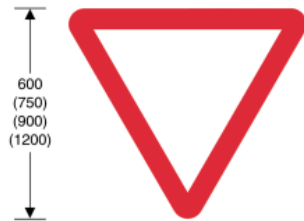

501  
Junction ahead controlled by a diagram 601.1 ("STOP") or diagram 602 ("GIVE WAY") sign

Item	
1	Regulations: None
2	Directions: 20(1), 21(1)
3	Diagrams: 502, 503, 608
4	Permitted variants: None
5	Illumination requirements: Schedule 17, item 1



502  
Distance to a junction ahead controlled by a diagram 601.1 ("STOP") sign

Item	
1	Regulations: None
2	Directions: 20(1), 21(1)
3	Diagrams: 501
4	Permitted variants: Schedule 16, item 6
5	Illumination requirements: Schedule 17, item 8



503  
Distance to a junction ahead controlled by a diagram 602 ("GIVE WAY") sign

Item	
1	Regulations: None
2	Directions: 20(1), 21(1)
3	Diagrams: 501
4	Permitted variants: Schedule 16, item 6
5	Illumination requirements: Schedule 17, item 8

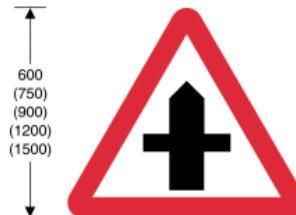

504.1  
Crossroads ahead

Item	
1	Regulations: 58(7)
2	Directions: 21(1)
3	Diagrams: 511, 572
4	Permitted variants: Schedule 16, item 17
5	Illumination requirements: Schedule 17, item 1

**Status:** This is the original version (as it was originally made). This item of legislation is currently only available in its original format.

SCHEDULE 1 WARNING SIGNS (contd.)



505.1  
T-junction ahead

Item	
1	Regulations: 58(7)
2	Directions: 21(1)
3	Diagrams: 511, 572
4	Permitted variants: Schedule 16, item 28
5	Illumination requirements: Schedule 17, item 1

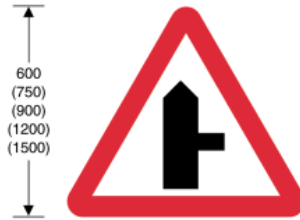

506.1  
Side road ahead

Item	
1	Regulations: 58(7)
2	Directions: 21(1)
3	Diagrams: 511, 572, 7301, 7302
4	Permitted variants: Schedule 16, items 17, 28
5	Illumination requirements: Schedule 17, item 1

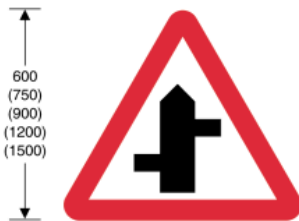

507.1  
Staggered junction ahead

Item	
1	Regulations: 58(7)
2	Directions: 21(1)
3	Diagrams: 511, 572
4	Permitted variants: Schedule 16, items 17, 28
5	Illumination requirements: Schedule 17, item 1



508.1  
Traffic merges ahead from the left

Item	
1	Regulations: None
2	Directions: 17, 21(1)
3	Diagrams: 572, 1010
4	Permitted variants: None
5	Illumination requirements: Schedule 17, item 1

**Status:** This is the original version (as it was originally made). This item of legislation is currently only available in its original format.

SCHEDULE 1 WARNING SIGNS (contd.)

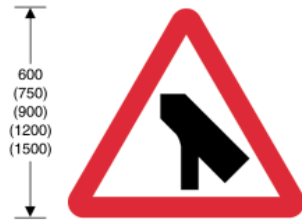

600  
(750)  
(900)  
(1200)  
(1500)

509.1

Traffic merges ahead onto main carriageway

Item	
1	Regulations: None
2	Directions: 17, 21(1)
3	Diagrams: 572, 1010
4	Permitted variants: None
5	Illumination requirements: Schedule 17, item 1



600  
(750)  
(900)  
(1200)  
(1500)

510

Roundabout ahead

Item	
1	Regulations: 58(7)
2	Directions: 21(1)
3	Diagrams: 511, 513.1, 572
4	Permitted variants: None
5	Illumination requirements: Schedule 17, item 1



62.5  
(75)  
(100)  
(125)  
(150)  
(200)

511

Reduction in speed necessary for a change in road layout ahead

Item	
1	Regulations: None
2	Directions: 21(1)
3	Diagrams: 504.1, 505.1, 506.1, 507.1, 510, 512, 512.1, 512.2, 513, 516, 517, 520, 523.1, 524.1, 528, 556
4	Permitted variants: "REDUCE SPEED NOW" may be varied to "HEAVY PLANT CROSSING" when used in combination with any of the signs in diagrams 504.1, 505.1, 506.1, 507.1, 512.1, 512.2
5	Illumination requirements: Schedule 17, item 8



600  
(750)  
(900)  
(1200)  
(1500)

512

Bend ahead

Item	
1	Regulations: 58(7)
2	Directions: 21(1)
3	Diagrams: 511, 513.1, 513.2, 526, 575
4	Permitted variants: Schedule 16, item 28
5	Illumination requirements: Schedule 17, item 1

**Status:** This is the original version (as it was originally made). This item of legislation is currently only available in its original format.

SCHEDULE 1 WARNING SIGNS (contd.)



600  
(750)  
(900)  
(1200)  
(1500)

512.1  
Junction on bend ahead

Item	
1	Regulations: 58(7)
2	Directions: 21(1)
3	Diagrams: 511, 513.1, 513.2, 526, 575
4	Permitted variants: Schedule 16, item 28
5	Illumination requirements: Schedule 17, item 1

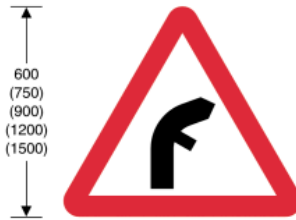

600  
(750)  
(900)  
(1200)  
(1500)

512.2  
Same as diagram 512.1

Item	
1	Regulations: 58(7)
2	Directions: 21(1)
3	Diagrams: 511, 513.1, 513.2, 526, 575
4	Permitted variants: Schedule 16, item 28
5	Illumination requirements: Schedule 17, item 1



600  
(750)  
(900)  
(1200)  
(1500)

513  
Double bend or series of bends ahead, first to the left

Item	
1	Regulations: 58(7)
2	Directions: 21(1)
3	Diagrams: 511, 513.1, 513.2, 526, 570, 575
4	Permitted variants: Schedule 16, item 28
5	Illumination requirements: Schedule 17, item 1



(50)  
62.5  
(75)  
(100)  
(125)  
(150)

513.1  
Adverse camber on a bend or roundabout

Item	
1	Regulations: None
2	Directions: 21(1)
3	Diagrams: 510, 512, 512.1, 512.2, 513
4	Permitted variants: None
5	Illumination requirements: Schedule 17, item 8

**Status:** This is the original version (as it was originally made). This item of legislation is currently only available in its original format.

SCHEDULE 1 WARNING SIGNS (contd.)



513.2  
Maximum speed in miles per hour advised at a bend or other hazard

Item	
1	Regulations: None
2	Directions: 21(1)
3	Diagrams: 512, 512.1, 512.2, 513, 7009
4	Permitted variants: Schedule 16, item 1
5	Illumination requirements: Schedule 17, item 8

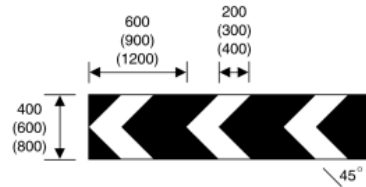

515  
Sharp deviation of route

Item	
1	Regulations: None
2	Directions: 20(3)
3	Diagrams: 515.2, 606
4	Permitted variants: Schedule 16, item 13 Number of chevrons may be varied. The corners of the sign may be rounded, with a radius not greater than 10 mm
5	Illumination requirements: Schedule 17, item 4

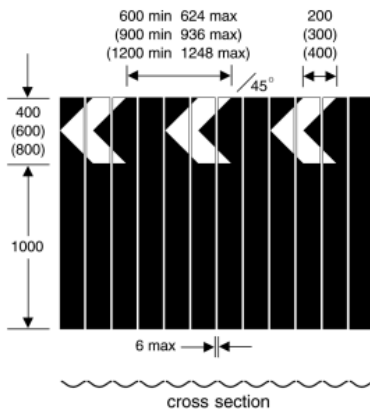

515.1  
Same as diagram 515

Item	
1	Regulations: 11(2)
2	Directions: None
3	Diagrams: None
4	Permitted variants: Schedule 16, items 13, 46 Same as diagram 515
5	Illumination requirements: Schedule 17, item 4

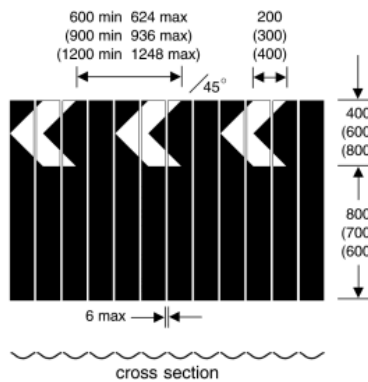

515.1A  
Sharp deviation of route at a roundabout

Item	
1	Regulations: 11(2)
2	Directions: 20(3)
3	Diagrams: 515.2, 606
4	Permitted variants: Schedule 16, item 46 Same as diagram 515
5	Illumination requirements: Schedule 17, item 4

**Status:** This is the original version (as it was originally made). This item of legislation is currently only available in its original format.

SCHEDULE 1 WARNING SIGNS (contd.)

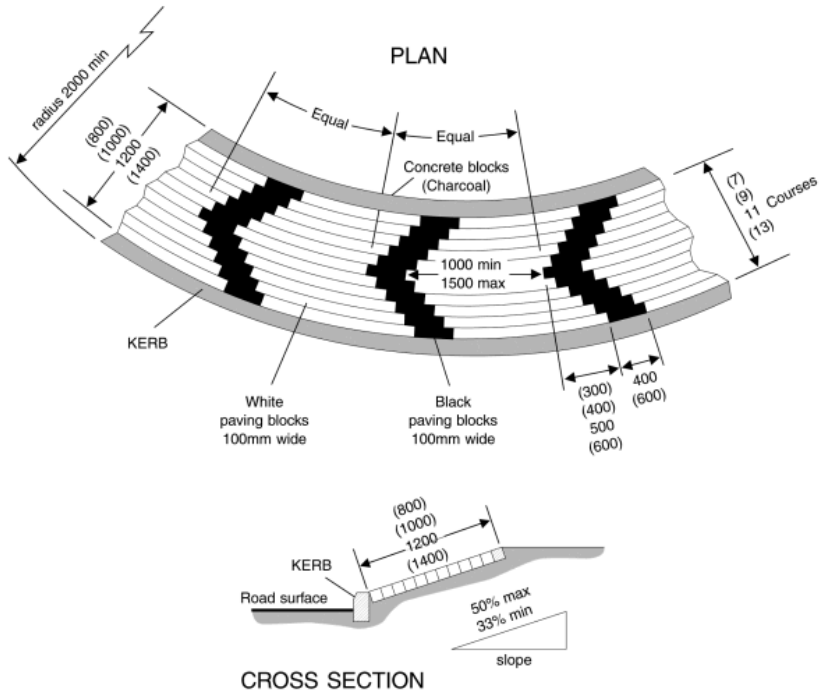

515.2  
Same as diagram 515.1A

Item	
1	Regulations: 11(2)
2	Directions: 20(3)
3	Diagrams: 515, 515.1A, 606
4	Permitted variants: None
5	Illumination requirements: Schedule 17, item 15

**Status:** This is the original version (as it was originally made). This item of legislation is currently only available in its original format.

SCHEDULE 1 WARNING SIGNS (contd.)

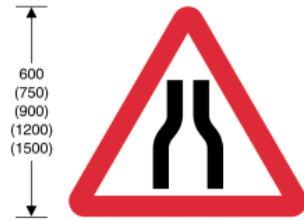

600  
(750)  
(900)  
(1200)  
(1500)

516

Road narrows on both sides ahead

Item	
1	Regulations: None
2	Directions: 21(1)
3	Diagrams: 511, 518, 519, 572, 575
4	Permitted variants: None
5	Illumination requirements: Schedule 17, item 1

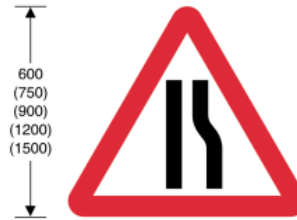

600  
(750)  
(900)  
(1200)  
(1500)

517

Road narrows on right ahead

Item	
1	Regulations: None
2	Directions: 21(1)
3	Diagrams: 511, 518, 519, 572, 575
4	Permitted variants: Schedule 16, item 28
5	Illumination requirements: Schedule 17, item 1



(50)  
62.5  
(75)  
(100)  
(125)  
(150)

518

Convergence of traffic to a single file in each direction

Item	
1	Regulations: None
2	Directions: 21(1)
3	Diagrams: 516, 517, 520
4	Permitted variants: Schedule 16, items 3, 6, 11 "for" may precede a distance where added
5	Illumination requirements: Schedule 17, item 8



50  
(62.5)  
(75)  
(100)

519

Road only wide enough for one line of vehicles

Item	
1	Regulations: None
2	Directions: 21(1)
3	Diagrams: 516, 517
4	Permitted variants: Schedule 16, items 3, 6, 11 Same as diagram 518. "Single track road" may be on three lines
5	Illumination requirements: Schedule 17, item 8

**Status:** This is the original version (as it was originally made). This item of legislation is currently only available in its original format.

SCHEDULE 1 WARNING SIGNS (contd.)



600  
(750)  
(900)  
(1200)  
(1500)

520  
Dual carriageway ends ahead

Item	
1	Regulations: None
2	Directions: 21(1)
3	Diagrams: 511, 518, 572
4	Permitted variants: None
5	Illumination requirements: Schedule 17, item 1

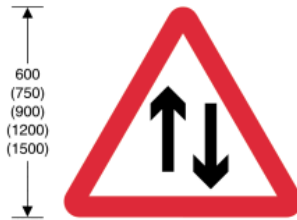

600  
(750)  
(900)  
(1200)  
(1500)

521  
Two-way traffic

Item	
1	Regulations: None
2	Directions: 21(1)
3	Diagrams: 570, 572
4	Permitted variants: None
5	Illumination requirements: Schedule 17, item 1



600  
(750)  
(900)  
(1200)

522  
Two-way traffic on route crossing ahead

Item	
1	Regulations: None
2	Directions: 21(1)
3	Diagrams: 572
4	Permitted variants: None
5	Illumination requirements: Schedule 17, item 1

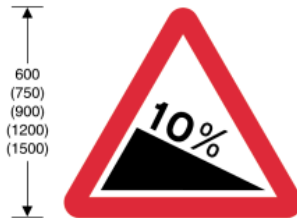

600  
(750)  
(900)  
(1200)  
(1500)

523.1  
Steep hill downwards ahead

Item	
1	Regulations: None
2	Directions: 21(1)
3	Diagrams: 511, 525, 526, 527, 570, 572, 573, 817.2
4	Permitted variants: Schedule 16, item 1
5	Illumination requirements: Schedule 17, item 1



**Status:** This is the original version (as it was originally made). This item of legislation is currently only available in its original format.

SCHEDULE 1 WARNING SIGNS (contd.)



524.1  
Steep hill upwards ahead

Item	
1	Regulations: None
2	Directions: 21(1)
3	Diagrams: 511, 525, 526, 527, 570, 572, 573
4	Permitted variants: Schedule 16, item 1
5	Illumination requirements: Schedule 17, item 1



525  
Drivers should engage low gear for steep hill

Item	
1	Regulations: None
2	Directions: 21(1)
3	Diagrams: 523.1, 524.1
4	Permitted variants: None
5	Illumination requirements: Schedule 17, item 8



526  
Drivers should keep in low gear for steep hill or tight bend

Item	
1	Regulations: None
2	Directions: 21(1)
3	Diagrams: 512, 512.1, 512.2, 513, 523.1, 524.1, 554.1
4	Permitted variants: None
5	Illumination requirements: Schedule 17, item 8

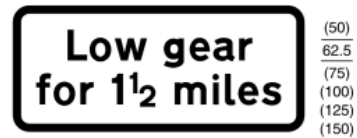

527  
Drivers should keep in low gear for distance indicated

Item	
1	Regulations: None
2	Directions: 21(1)
3	Diagrams: 523.1, 524.1
4	Permitted variants: Schedule 16, item 5
5	Illumination requirements: Schedule 17, item 8

**Status:** This is the original version (as it was originally made). This item of legislation is currently only available in its original format.

SCHEDULE 1 WARNING SIGNS (contd.)

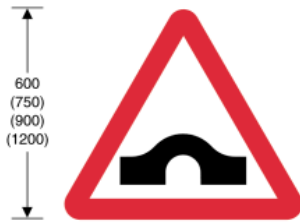

528  
Hump bridge ahead

Item	
1	Regulations: None
2	Directions: 21(1)
3	Diagrams: 511, 572, 573, 575, 782
4	Permitted variants: None
5	Illumination requirements: Schedule 17, item 1

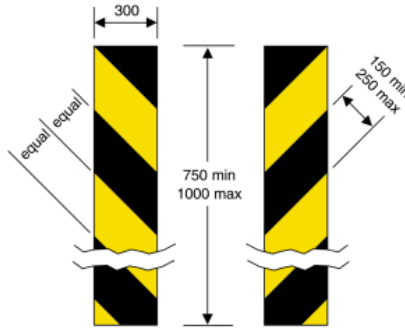

528.1  
End of bridge parapet, abutment wall, tunnel mouth,  
or other obstruction adjacent to the carriageway

Item	
1	Regulations: None
2	Directions: None
3	Diagrams: None
4	Permitted variants: None
5	Illumination requirements: Schedule 17, item 4 The parts of the sign coloured yellow may be fluorescent as well as retroreflective



529  
Opening or swing bridge ahead

Item	
1	Regulations: None
2	Directions: 21(1)
3	Diagrams: 572, 573, 773
4	Permitted variants: None
5	Illumination requirements: Schedule 17, item 1

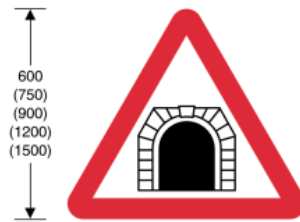

529.1  
Tunnel ahead

Item	
1	Regulations: None
2	Directions: 21(1)
3	Diagrams: 572, 573, 575, 773
4	Permitted variants: None
5	Illumination requirements: Schedule 17, item 1

**Status:** This is the original version (as it was originally made). This item of legislation is currently only available in its original format.

SCHEDULE 1 WARNING SIGNS (contd.)

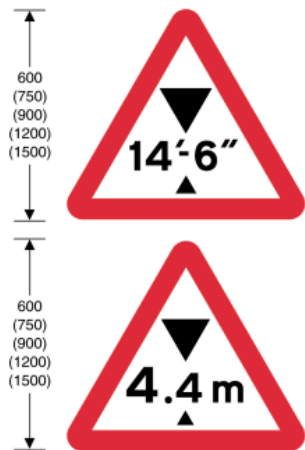

530  
Maximum headroom available at hazard

Item	
1	Regulations: None
2	Directions: 21(1)
3	Diagrams: 530.1, 530.2, 572, 573
4	Permitted variants: Schedule 16, item 1 Metric sign may be omitted or placed to the right of the imperial sign
5	Illumination requirements: Schedule 17, item 1



530.1  
Reduced headroom over part of road due to overhanging building ahead

Item	
1	Regulations: None
2	Directions: 21(1)
3	Diagrams: 530
4	Permitted variants: Schedule 16, items 3, 6, 11 "building" may be varied to "buildings" or "structure"
5	Illumination requirements: Schedule 17, item 8

**Status:** This is the original version (as it was originally made). This item of legislation is currently only available in its original format.

SCHEDULE 1 WARNING SIGNS (contd.)

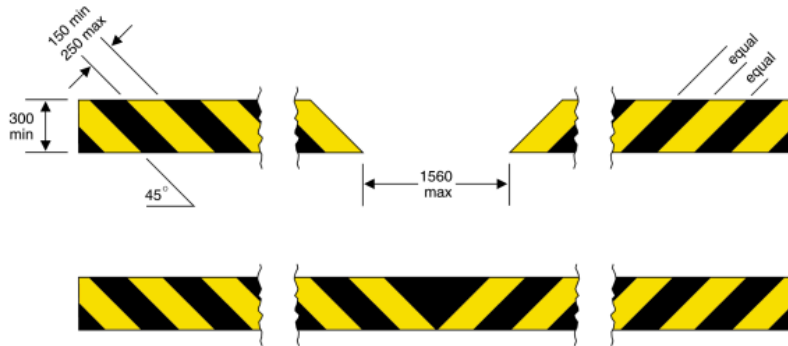

530.2  
Reduced headroom at a hazard  
(Alternative types)

Item	
1	Regulations: None
2	Directions: 21(1)
3	Diagrams: 530, 629.2, 629.2A
4	Permitted variants: None
5	Illumination requirements: Schedule 17, item 9 Where those parts of the sign coloured yellow are retroreflective they may also be fluorescent

**Status:** This is the original version (as it was originally made). This item of legislation is currently only available in its original format.

SCHEDULE 1 WARNING SIGNS (contd.)

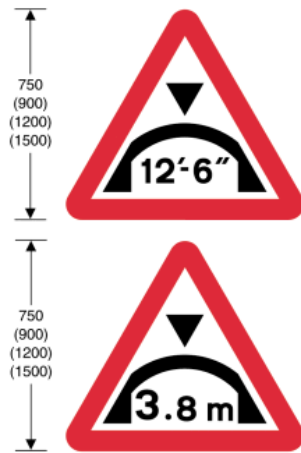

531.1  
Maximum headroom available  
at arch bridge ahead

Item	
1	Regulations: None
2	Directions: 21(1)
3	Diagrams: 531.2, 572, 573
4	Permitted variants: Schedule 16, item 1 Metric sign may be omitted
5	Illumination requirements: Schedule 17, item 1

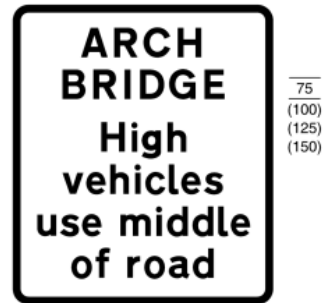

531.2  
High vehicles to use the middle of road  
at arch bridge ahead

Item	
1	Regulations: None
2	Directions: 21(1)
3	Diagrams: 531.1
4	Permitted variants: Schedule 16, item 11
5	Illumination requirements: Schedule 17, item 8

**Status:** This is the original version (as it was originally made). This item of legislation is currently only available in its original format.

SCHEDULE 1 WARNING SIGNS (contd.)

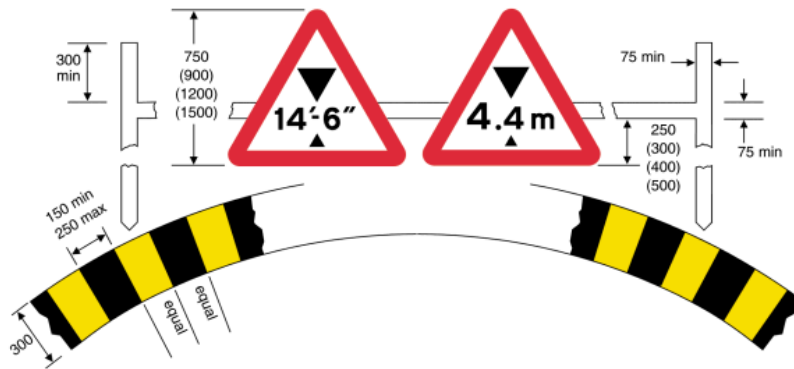

532.2  
Maximum headroom available  
in the centre of a road at an arch bridge

Item	
1	Regulations: None
2	Directions: None
3	Diagrams: None
4	Permitted variants: Schedule 16, item 1 Black and yellow markings may be omitted. Metric sign may be omitted
5	Illumination requirements: Schedule 17, items 1, 9 Same as diagram 530.2

**Status:** This is the original version (as it was originally made). This item of legislation is currently only available in its original format.

SCHEDULE 1 WARNING SIGNS (contd.)

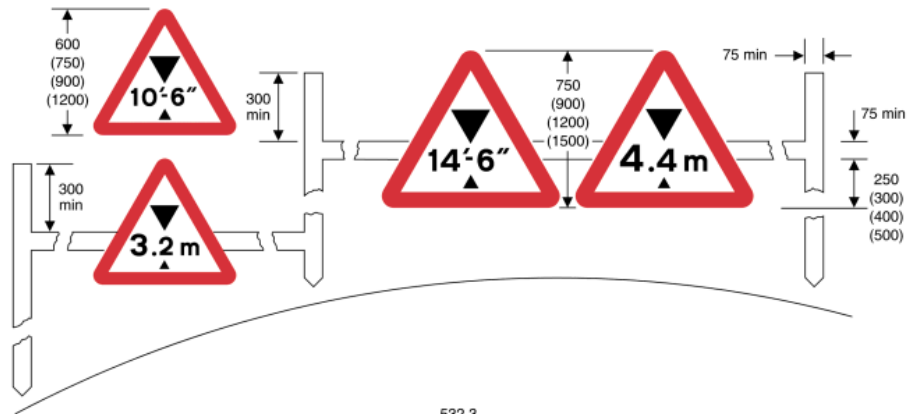

532.3  
Maximum headroom available at the side of  
and in the centre of a road at an arch bridge

Item	
1	Regulations: None
2	Directions: None
3	Diagrams: None
4	Permitted variants: Schedule 16, item 1 Metric signs may be omitted. Black and yellow markings shown in diagram 532.2 may be added
5	Illumination requirements: Schedule 17, items 1, 9

**Status:** This is the original version (as it was originally made). This item of legislation is currently only available in its original format.

SCHEDULE 1 WARNING SIGNS (contd.)

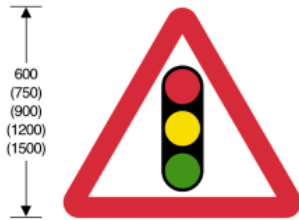

543  
Traffic signals ahead

Item	
1	Regulations: None
2	Directions: 21(1), 39(2)
3	Diagrams: 543.1, 547.8, 572, 573, 7030
4	Permitted variants: None
5	Illumination requirements: Schedule 17, item 1



543.1  
Traffic signals ahead  
which only operate at certain times

Item	
1	Regulations: None
2	Directions: 21(1)
3	Diagrams: 543, 3000, 3000.7, 3000.8, 3000.9, 3000.10
4	Permitted variants: Schedule 16, items 3, 6, 11 "Part time" may be varied to "Peak hour"
5	Illumination requirements: Schedule 17, item 8



544  
Zebra crossing ahead

Item	
1	Regulations: None
2	Directions: 21(1)
3	Diagrams: 547.8, 572, 573
4	Permitted variants: None
5	Illumination requirements: Schedule 17, item 1

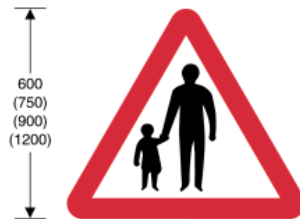

544.1  
Pedestrians in road ahead

Item	
1	Regulations: None
2	Directions: 21(1)
3	Diagrams: 547.3, 572, 573
4	Permitted variants: None
5	Illumination requirements: Schedule 17, item 1



**Status:** This is the original version (as it was originally made). This item of legislation is currently only available in its original format.

SCHEDULE 1 WARNING SIGNS (contd.)

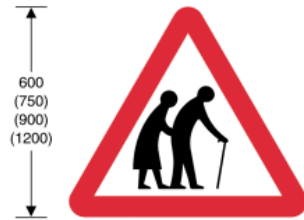

544.2  
Frail or disabled pedestrians likely to cross road ahead

Item	
1	Regulations: None
2	Directions: 21(1)
3	Diagrams: 547.4, 572, 573
4	Permitted variants: None
5	Illumination requirements: Schedule 17, item 1



545  
Children going to or from school or playground ahead

Item	
1	Regulations: None
2	Directions: 20(2), 21(1), 27, 55(1)
3	Diagrams: 546, 547.1, 547.2, 547.3, 547.7, 4004
4	Permitted variants: None
5	Illumination requirements: Schedule 17, item 1



546  
School ahead

Item	
1	Regulations: None
2	Directions: 20(2), 21(1), 27, 55(1)
3	Diagrams: 545, 4004
4	Permitted variants: Schedule 16, items 3, 6, 11
5	Illumination requirements: Schedule 17, item 8



547.1  
School crossing patrol ahead

Item	
1	Regulations: None
2	Directions: 20(2), 21(1), 27, 55(1)
3	Diagrams: 545, 4004
4	Permitted variants: Schedule 16, items 3, 6, 11
5	Illumination requirements: Schedule 17, item 8

*Status: This is the original version (as it was originally made). This item of legislation is currently only available in its original format.*

SCHEDULE 1 WARNING SIGNS (contd.)

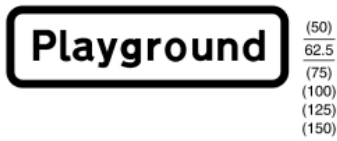

(50)  
62.5  
(75)  
(100)  
(125)  
(150)

547.2  
Children's playground ahead

Item	
1	Regulations: None
2	Directions: 20(2), 21(1)
3	Diagrams: 545
4	Permitted variants: Schedule 16, items 3, 6, 11
5	Illumination requirements: Schedule 17, item 8



(50)  
62.5  
(75)  
(100)  
(125)  
(150)

547.3  
No footway for distance indicated

Item	
1	Regulations: None
2	Directions: 20(2), 21(1)
3	Diagrams: 544.1, 545
4	Permitted variants: Schedule 16, item 6
5	Illumination requirements: Schedule 17, item 8



(50)  
62.5  
(75)  
(100)  
(125)  
(150)

547.4  
Disabled pedestrians likely to cross road ahead

Item	
1	Regulations: None
2	Directions: 21(1)
3	Diagrams: 544.2
4	Permitted variants: Schedule 16, items 3, 6, 11 "Disabled" may be varied to "Blind"
5	Illumination requirements: Schedule 17, item 8



(50)  
62.5  
(75)  
(100)  
(125)  
(150)

547.7  
Disabled children likely to cross road ahead

Item	
1	Regulations: None
2	Directions: 20(2), 21(1), 27, 55(1)
3	Diagrams: 545, 4004
4	Permitted variants: Schedule 16, items 3, 6, 11 "Disabled" may be varied to "Blind" or "Deaf"
5	Illumination requirements: Schedule 17, item 8

**Status:** This is the original version (as it was originally made). This item of legislation is currently only available in its original format.

SCHEDULE 1 WARNING SIGNS (contd.)



(50)  
62.5  
(75)  
(100)  
(125)

547.8  
Zebra crossing or signal-controlled crossing on road hump ahead

Item	
1	Regulations: None
2	Directions: 21(1)
3	Diagrams: 543, 544
4	Permitted variants: Schedule 16, items 3, 6, 11
5	Illumination requirements: Schedule 17, item 8



600  
(750)  
(900)  
(1200)  
(1500)

548  
Cattle likely to be in road ahead

Item	
1	Regulations: None
2	Directions: 21(1), 55(2)
3	Diagrams: 548.1, 570, 4005
4	Permitted variants: None
5	Illumination requirements: Schedule 17, item 4



(50)  
62.5  
(75)  
(100)  
(125)  
(150)

548.1  
Supervised cattle crossing ahead

Item	
1	Regulations: None
2	Directions: 21(1), 55(2)
3	Diagrams: 548, 4005
4	Permitted variants: Schedule 16, items 6, 11
5	Illumination requirements: Schedule 17, item 8

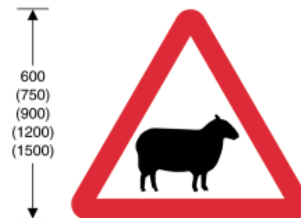

600  
(750)  
(900)  
(1200)  
(1500)

549  
Sheep likely to be in road ahead

Item	
1	Regulations: None
2	Directions: 21(1)
3	Diagrams: 570
4	Permitted variants: None
5	Illumination requirements: Schedule 17, item 4

**Status:** This is the original version (as it was originally made). This item of legislation is currently only available in its original format.

SCHEDULE 1 WARNING SIGNS (contd.)



550  
Wild horses or ponies likely to be in road ahead

Item	
1	Regulations: None
2	Directions: 21(1)
3	Diagrams: 570
4	Permitted variants: None
5	Illumination requirements: Schedule 17, item 4



550.1  
Accompanied horses or ponies likely to be in or crossing road ahead

Item	
1	Regulations: None
2	Directions: 21(1)
3	Diagrams: 570, 572, 573
4	Permitted variants: None
5	Illumination requirements: Schedule 17, item 4

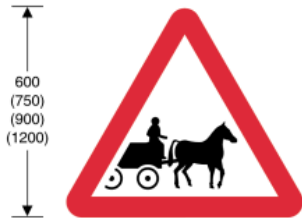

550.2  
Horse drawn vehicles likely to be in road ahead

Item	
1	Regulations: None
2	Directions: 21(1)
3	Diagrams: 570
4	Permitted variants: None
5	Illumination requirements: Schedule 17, item 4



551  
Wild animals likely to be in road ahead

Item	
1	Regulations: None
2	Directions: 21(1)
3	Diagrams: 570
4	Permitted variants: None
5	Illumination requirements: Schedule 17, item 4

**Status:** This is the original version (as it was originally made). This item of legislation is currently only available in its original format.

SCHEDULE 1 WARNING SIGNS (contd.)



551.1  
Migratory toad crossing ahead

Item	
1	Regulations: None
2	Directions: 21(1), 28
3	Diagrams: 570
4	Permitted variants: None
5	Illumination requirements: Schedule 17, item 4

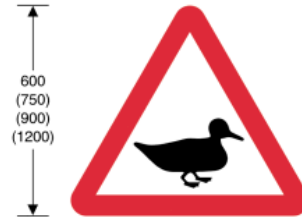

551.2  
Wild fowl likely to be in road ahead

Item	
1	Regulations: None
2	Directions: 21(1)
3	Diagrams: 570
4	Permitted variants: None
5	Illumination requirements: Schedule 17, item 4

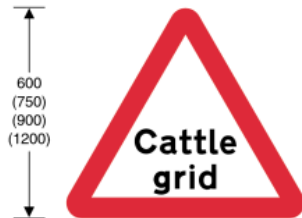

552  
Cattle grid ahead

Item	
1	Regulations: None
2	Directions: 21(1)
3	Diagrams: 553, 572, 573
4	Permitted variants: None
5	Illumination requirements: Schedule 17, item 4



553  
By-pass of cattle grid

Item	
1	Regulations: None
2	Directions: 21(1)
3	Diagrams: 552
4	Permitted variants: Schedule 16, item 13
5	Illumination requirements: Schedule 17, item 8

**Status:** This is the original version (as it was originally made). This item of legislation is currently only available in its original format.

SCHEDULE 1 WARNING SIGNS (contd.)



553.1  
Agricultural vehicles likely to be in road ahead

Item	
1	Regulations: None
2	Directions: 20(1), 21(1)
3	Diagrams: 553.2
4	Permitted variants: None
5	Illumination requirements: Schedule 17, item 4

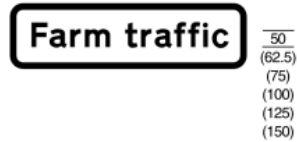

553.2  
Agricultural vehicles likely to be in road ahead

Item	
1	Regulations: None
2	Directions: 20(1), 21(1)
3	Diagrams: 553.1
4	Permitted variants: Schedule 16, item 6 "Farm traffic" may be varied to "Wide vehicles" or "Tractors turning". "for" and a distance may be added
5	Illumination requirements: Schedule 17, item 8

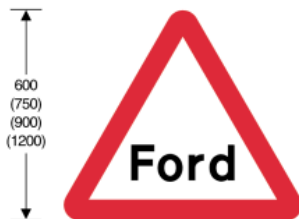

554  
Worded warning sign

Item	
1	Regulations: None
2	Directions: 21(1), 39(3)
3	Diagrams: 563 (when varied to "Road liable to flooding"), 570 (when diagram 554 is varied to "Gates"), 572, 573
4	Permitted variants: "Ford" may be varied to "Flood", "Gate", "Gates", or "No smoking"
5	Illumination requirements: Schedule 17, item 4

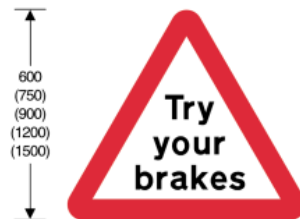

554.1  
Risk of brake failure after crossing a ford or before descending a steep gradient

Item	
1	Regulations: None
2	Directions: 21(1)
3	Diagrams: 526, 817.2
4	Permitted variants: None
5	Illumination requirements: Schedule 17, item 4

**Status:** This is the original version (as it was originally made). This item of legislation is currently only available in its original format.

SCHEDULE 1 WARNING SIGNS (contd.)



554.2  
Risk of ice or packed snow ahead

Item	
1	Regulations: None
2	Directions: 20(1), 21(1), 39(3)
3	Diagrams: 554.3
4	Permitted variants: None
5	Illumination requirements: Schedule 17, item 4

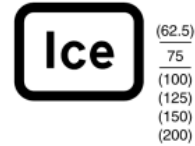

554.3  
Ice ahead

Item	
1	Regulations: None
2	Directions: 20(1), 21(1), 39(3)
3	Diagrams: 554.2, 622.1A, 622.4, 629, 629A, 629.1, 632
4	Permitted variants: Schedule 16, item 6 "Ice" may be varied to "Snowdrifts". "for" and a distance may be added
5	Illumination requirements: Schedule 17, item 8



555  
Quayside or river bank ahead

Item	
1	Regulations: None
2	Directions: 21(1)
3	Diagrams: 572, 573
4	Permitted variants: None
5	Illumination requirements: Schedule 17, item 1



555.1  
Water course alongside road ahead

Item	
1	Regulations: None
2	Directions: 21(1)
3	Diagrams: 570
4	Permitted variants: Schedule 16, item 28
5	Illumination requirements: Schedule 17, item 4

**Status:** This is the original version (as it was originally made). This item of legislation is currently only available in its original format.

SCHEDULE 1 WARNING SIGNS (contd.)



556  
Uneven road ahead

Item	
1	Regulations: None
2	Directions: 21(1)
3	Diagrams: 511, 570
4	Permitted variants: None
5	Illumination requirements: Schedule 17, item 4



556.1  
Soft verges ahead

Item	
1	Regulations: None
2	Directions: 20(1), 21(1)
3	Diagrams: 556.2
4	Permitted variants: None
5	Illumination requirements: Schedule 17, item 4



556.2  
Soft verges for distance indicated

Item	
1	Regulations: None
2	Directions: 20(1), 21(1)
3	Diagrams: 556.1
4	Permitted variants: Schedule 16, item 6 "for 2 miles" may be omitted
5	Illumination requirements: Schedule 17, item 8



557  
Slippery road ahead

Item	
1	Regulations: None
2	Directions: 21(1)
3	Diagrams: 570
4	Permitted variants: None
5	Illumination requirements: Schedule 17, item 4



**Status:** This is the original version (as it was originally made). This item of legislation is currently only available in its original format.

SCHEDULE 1 WARNING SIGNS (contd.)



600  
(750)  
(900)  
(1200)

557.1  
Road hump or series of road humps ahead

Item	
1	Regulations: None
2	Directions: 17, 18(1), 20(1), 21(1)
3	Diagrams: 557.2, 557.3, 557.4, 1062
4	Permitted variants: None
5	Illumination requirements: Schedule 17, item 1



557.2  
Road humps ahead for the distance indicated

Item	
1	Regulations: None
2	Directions: 20(1), 21(1)
3	Diagrams: 557.1
4	Permitted variants: Schedule 16, item 6
5	Illumination requirements: Schedule 17, item 8



557.3  
Road humps ahead in the direction and for the distance indicated

Item	
1	Regulations: None
2	Directions: 20(1), 21(1)
3	Diagrams: 557.1
4	Permitted variants: Schedule 16, items 6, 13 A second arrow pointing in the opposite direction may be added. "for 300 yards" may be omitted
5	Illumination requirements: Schedule 17, item 8

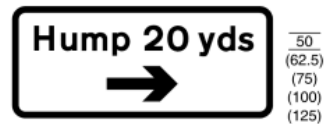

557.4  
Road hump in the direction and at the distance indicated

Item	
1	Regulations: None
2	Directions: 20(1), 21(1)
3	Diagrams: 557.1
4	Permitted variants: Schedule 16, items 6, 9, 13, 14 A second arrow pointing in the opposite direction may be added. The legend may be on two lines
5	Illumination requirements: Schedule 17, item 8

**Status:** This is the original version (as it was originally made). This item of legislation is currently only available in its original format.

SCHEDULE 1 WARNING SIGNS (contd.)



558  
Low flying aircraft or sudden aircraft noise likely ahead

Item	
1	Regulations: None
2	Directions: 21(1)
3	Diagrams: 558.2, 570, 773
4	Permitted variants: None
5	Illumination requirements: Schedule 17, item 4

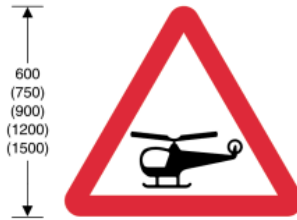

558.1  
Low flying helicopters or sudden helicopter noise likely ahead

Item	
1	Regulations: None
2	Directions: 21(1)
3	Diagrams: 570
4	Permitted variants: None
5	Illumination requirements: Schedule 17, item 4



558.2  
Gliders likely ahead

Item	
1	Regulations: None
2	Directions: 21(1)
3	Diagrams: 558
4	Permitted variants: Schedule 16, item 6 "for" and a distance may be added
5	Illumination requirements: Schedule 17, item 8

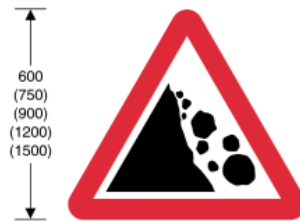

559  
Risk of falling or fallen rocks ahead

Item	
1	Regulations: None
2	Directions: 21(1)
3	Diagrams: 570
4	Permitted variants: Schedule 16, item 28
5	Illumination requirements: Schedule 17, item 4

**Status:** This is the original version (as it was originally made). This item of legislation is currently only available in its original format.

SCHEDULE 1 WARNING SIGNS (contd.)



560  
Edge of carriageway or obstruction near that edge

Item	
1	Regulations: 21, 56(6)
2	Directions: 44
3	Diagrams: None
4	Permitted variants: The portion of the sign coloured red may be varied to white or amber
5	Illumination requirements: Schedule 17, item 13

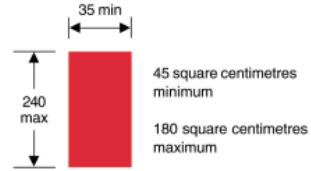

561  
Alternative shape for the sign shown in diagram 560

Item	
1	Regulations: 21, 56(6)
2	Directions: 44
3	Diagrams: None
4	Permitted variants: Same as diagram 560 The surface of the sign may be curved
5	Illumination requirements: Schedule 17, item 13



562  
Other danger ahead

Item	
1	Regulations: 54
2	Directions: 20(1), 21(1), 39(3)
3	Diagrams: 563, 563.1, 7022
4	Permitted variants: None
5	Illumination requirements: Schedule 17, item 4



563  
Nature of other danger ahead

Item	
1	Regulations: None
2	Directions: 20(1), 21(1), 39(3)
3	Diagrams: 554 (when diagram 563 is varied to "Road liable to flooding"), 562
4	Permitted variants: Schedule 16, items 3, 6, 11 "Accident" may be varied to: 1. "Ambulance station" 2. "Blasting" 3. "Blind summit" 4. "Census" 5. "Dust cloud" 6. "Fallen tree" 7. "Fire station" 8. "Frost damage" 9. "Hidden dip" 10. "Overhead cable repairs" 11. "Pedestrians crossing" 12. "Road liable to flooding" 13. "Runners in road" 14. "Smoke" 15. "Walkers in road"
5	Illumination requirements: Schedule 17, item 8

*Status: This is the original version (as it was originally made). This item of legislation is currently only available in its original format.*

SCHEDULE 1 WARNING SIGNS (contd.)

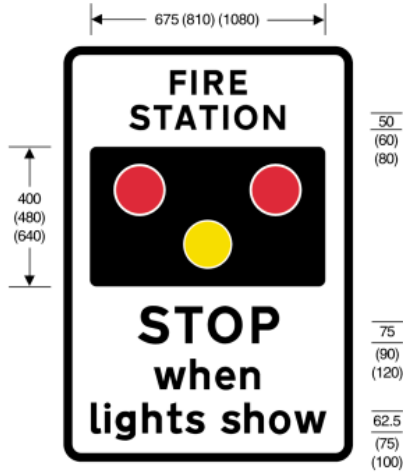

563.1  
Warning of light signals as shown in diagram 3014 ahead

Item	
1	Regulations: None
2	Directions: 20(1), 21(1)
3	Diagrams: 562
4	Permitted variants: Schedule 16, items 3, 6, 11 "FIRE" may be varied to "AMBULANCE" or "FIRE AND AMBULANCE"
5	Illumination requirements: Schedule 17, item 8



570  
Distance over which hazard or prohibition extends

Item	
1	Regulations: None
2	Directions: 21(1)
3	Diagrams: 513, 521, 523.1, 524.1, 548, 549, 550, 550.1, 550.2, 551, 551.1, 551.2, 554 (when varied to "Gates"), 555.1, 556, 557, 558, 558.1, 559, 581, 582, 614, 632, 642, 7001, 7009
4	Permitted variants: Schedule 16, item 6
5	Illumination requirements: Schedule 17, item 8



572  
Distance ahead to hazard

Item	
1	Regulations: None
2	Directions: 21(1)
3	Diagrams: 504.1, 505.1, 506.1, 507.1, 508.1, 509.1, 510, 516, 517, 520, 521, 522, 523.1, 524.1, 528, 529, 529.1, 530, 531.1, 543, 544, 544.1, 544.2, 550.1, 552, 554, 555, 770, 771, 772, 782, 950, 7001, 7009
4	Permitted variants: Schedule 16, item 6
5	Illumination requirements: Schedule 17, item 8



573  
Distance and direction to hazard

Item	
1	Regulations: None
2	Directions: 21(1)
3	Diagrams: 523.1, 524.1, 528, 529, 529.1, 530, 531.1, 543, 544, 544.1, 544.2, 550.1, 552, 554, 555, 770, 771, 772, 782, 950, 7001, 7009
4	Permitted variants: Schedule 16, items 6, 9, 13
5	Illumination requirements: Schedule 17, item 8

**Status:** This is the original version (as it was originally made). This item of legislation is currently only available in its original format.

SCHEDULE 1 WARNING SIGNS (contd.)



— 40 min  
— 200 max



(50)  
62.5  
(75)  
(100)  
(125)  
(150)

574  
Area infected by animal disease ahead

575  
Large vehicles likely to be in middle of road because of narrowness of carriageway

Item	
1	Regulations: None
2	Directions: 29
3	Diagrams: None
4	Permitted variants: "RABIES" may be omitted or varied to any appropriate animal disease name on one or two lines. "AHEAD" may be omitted or varied to "ENDS" or a horizontal arrow pointing left or right
5	Illumination requirements: Schedule 17, item 4

Item	
1	Regulations: None
2	Directions: 21(1)
3	Diagrams: 512, 512.1, 512.2, 513, 516, 517, 528, 529.1
4	Permitted variants: None
5	Illumination requirements: Schedule 17, item 8



581  
Side winds likely ahead

Item	
1	Regulations: None
2	Directions: 21(1)
3	Diagrams: 570
4	Permitted variants: None
5	Illumination requirements: Schedule 17, item 4

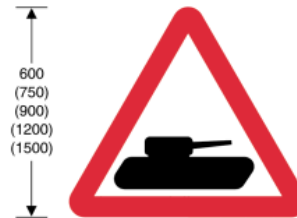

582  
Slow moving military vehicles likely to be crossing or in road ahead

Item	
1	Regulations: None
2	Directions: 21(1)
3	Diagrams: 570
4	Permitted variants: None
5	Illumination requirements: Schedule 17, item 4

**Status:** This is the original version (as it was originally made). This item of legislation is currently only available in its original format.

SCHEDULE 1 WARNING SIGNS (contd.)



583  
Slow moving vehicles likely on incline ahead

Item	
1	Regulations: None
2	Directions: 20(1), 21(1)
3	Diagrams: 583.1
4	Permitted variants: None
5	Illumination requirements: Schedule 17, item 4

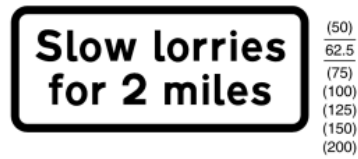

583.1  
Distance over which slow moving vehicles likely to be encountered ahead

Item	
1	Regulations: None
2	Directions: 20(1), 21(1)
3	Diagrams: 583
4	Permitted variants: Schedule 16, item 5
5	Illumination requirements: Schedule 17, item 8



584  
Traffic queues likely on road ahead

Item	
1	Regulations: None
2	Directions: 20(1), 21(1)
3	Diagrams: 584.1
4	Permitted variants: None
5	Illumination requirements: Schedule 17, item 4

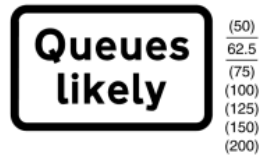

584.1  
Traffic queues likely on road ahead

Item	
1	Regulations: None
2	Directions: 20(1), 21(1)
3	Diagrams: 584
4	Permitted variants: Schedule 16, item 11 "on slip road" may be added
5	Illumination requirements: Schedule 17, item 8

**Status:** This is the original version (as it was originally made). This item of legislation is currently only available in its original format.

## SCHEDULE 2 REGULATORY SIGNS

### SCHEDULE 2

Regulation 11(1)

### REGULATORY SIGNS

(other than those exclusively for railway and tramway level crossings,  
bus and pedal cycle facilities, and road works)

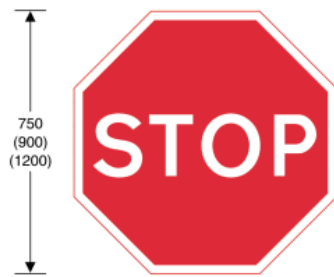

601.1  
Vehicular traffic must comply with  
the requirements prescribed in regulation 16

Item	
1	Regulations: 4, 10(1), 10(2), 16
2	Directions: 6, 17, 18(3), 20(1), 21(1), 30
3	Diagrams: 608, 783, 1002.1, 1022
4	Permitted variants: None
5	Illumination requirements: Schedule 17, item 1



602  
Vehicular traffic must comply with  
the requirements prescribed in regulation 16

Item	
1	Regulations: 4, 10(1), 16, 25
2	Directions: 17, 18(3), 20(1), 21(1), 34(1)
3	Diagrams: 608, 611.1, 774, 778, 778.1, 1003, 1003.4, 1023
4	Permitted variants: None
5	Illumination requirements: Schedule 17, item 1

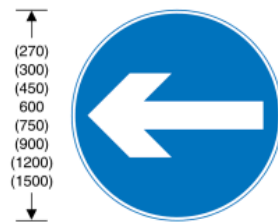

606  
Vehicular traffic must proceed in the direction  
indicated by the arrow

Item	
1	Regulations: 10(1), 12(7), 47(3), 48(3), 49(3), 54
2	Directions: 7, 20(3), 21(1)
3	Diagrams: 515, 515.1A, 515.2, 607, 608, 954, 954.2, 954.3, 954.4, 954.5, 954.6, 954.7
4	Permitted variants: Schedule 16, item 13
5	Illumination requirements: Schedule 17, items 1, 6, 7

**Status:** This is the original version (as it was originally made). This item of legislation is currently only available in its original format.

SCHEDULE 2 REGULATORY SIGNS (contd.)



(50)  
62.5  
(75)  
(100)  
(125)

607  
One-way traffic

Item	
1	Regulations: 12(7)
2	Directions: 7, 21(1)
3	Diagrams: 606, 609
4	Permitted variants: None
5	Illumination requirements: Schedule 17, item 8



(50)  
62.5  
(75)  
(100)  
(125)

608  
Dual carriageway

Item	
1	Regulations: None
2	Directions: 7(3), 21(1)
3	Diagrams: 501, 601.1, 602, 606, 609, 610
4	Permitted variants: None
5	Illumination requirements: Schedule 17, item 8

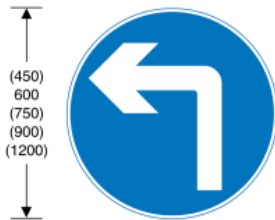

(450)  
600  
(750)  
(900)  
(1200)

609  
Vehicular traffic must turn ahead in the direction indicated by the arrow

Item	
1	Regulations: 10(1), 12(7), 54
2	Directions: 7, 21(1)
3	Diagrams: 607, 608, 954, 954.2, 954.3, 954.4
4	Permitted variants: Schedule 16, item 28
5	Illumination requirements: Schedule 17, item 1

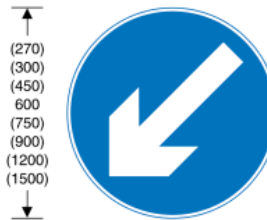

(270)  
(300)  
(450)  
600  
(750)  
(900)  
(1200)  
(1500)

610  
Vehicular traffic must comply with the requirements prescribed in regulation 15

Item	
1	Regulations: 10(1), 12(7), 14(1), 15, 26(6), 27(1), 54
2	Directions: 21(1)
3	Diagrams: 608
4	Permitted variants: Arrow may point downwards to the right
5	Illumination requirements: Schedule 17, items 1, 7



**Status:** This is the original version (as it was originally made). This item of legislation is currently only available in its original format.

SCHEDULE 2 REGULATORY SIGNS (contd.)

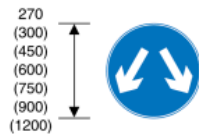

611  
Vehicular traffic may reach the same destination by proceeding either side of the sign

Item	
1	Regulations: 12(7), 27(1)
2	Directions: None
3	Diagrams: None
4	Permitted variants: None
5	Illumination requirements: Schedule 17, items 1, 7

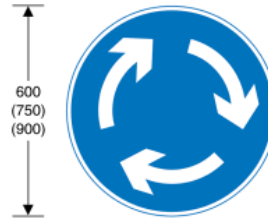

611.1  
Vehicles entering the junction must comply with the requirements prescribed in regulation 16

Item	
1	Regulations: 10(1), 12(7), 16, 25
2	Directions: 17, 18(1), 18(3)
3	Diagrams: 602, 1003, 1003.3, 1003.4, 1023
4	Permitted variants: None
5	Illumination requirements: Schedule 17, item 1

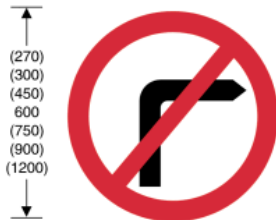

612  
No right turn for vehicular traffic

Item	
1	Regulations: 12(7), 27(1), 47(3), 48(3), 49(3)
2	Directions: 7, 21(1)
3	Diagrams: 954, 954.2, 954.3, 954.4, 954.5, 954.6, 954.7
4	Permitted variants: None
5	Illumination requirements: Schedule 17, items 1, 6

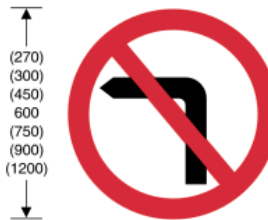

613  
No left turn for vehicular traffic

Item	
1	Regulations: 12(7), 27(1), 47(3), 48(3), 49(3)
2	Directions: 7, 21(1)
3	Diagrams: 954, 954.2, 954.3, 954.4, 954.5, 954.6, 954.7
4	Permitted variants: None
5	Illumination requirements: Schedule 17, items 1, 6

**Status:** This is the original version (as it was originally made). This item of legislation is currently only available in its original format.

SCHEDULE 2 REGULATORY SIGNS (contd.)

(270)  
(300)  
(450)  
600  
(750)  
(900)  
(1200)



614  
No U-turns for vehicular traffic

Item	
1	Regulations: 12(7)
2	Directions: 7, 11, 21(1)
3	Diagrams: 570, 645
4	Permitted variants: None
5	Illumination requirements: Schedule 17, items 1, 6

(600)  
750  
(900)  
(1200)



615  
Priority must be given to vehicles from the opposite direction

Item	
1	Regulations: 10(1)
2	Directions: 19, 20(1), 21(1)
3	Diagrams: 615.1, 645, 811, 1003, 1023, 1043, 1044
4	Permitted variants: None
5	Illumination requirements: Schedule 17, item 1



615.1  
Same as diagram 615

Item	
1	Regulations: None
2	Directions: 20(1), 21(1)
3	Diagrams: 615
4	Permitted variants: Schedule 16, item 6 "for" and a distance may be added
5	Illumination requirements: Schedule 17, item 8

(62.5)  
75  
(100)  
(125)

(270)  
(450)  
(600)  
750  
(900)  
(1200)



616  
No entry for vehicular traffic

Item	
1	Regulations: 10(1), 10(2), 12(7), 27(1), 47(3), 48(3), 49(3), 54
2	Directions: 7, 8, 18(4), 21(1), 21(2)
3	Diagrams: 954, 954.2, 1046, 1048.3
4	Permitted variants: None
5	Illumination requirements: Schedule 17, items 1, 7

**Status:** This is the original version (as it was originally made). This item of legislation is currently only available in its original format.

SCHEDULE 2 REGULATORY SIGNS (contd.)

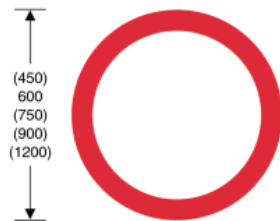

617

All vehicles prohibited except non-mechanically propelled vehicles being pushed by pedestrians

Item	
1	Regulations: None
2	Directions: 7, 8, 20(1), 21(1)
3	Diagrams: 618, 618.1, 1046 varied to "PLAY STREET" (when diagram 617 is used with 618)
4	Permitted variants: None
5	Illumination requirements: Schedule 17, items 1, 9

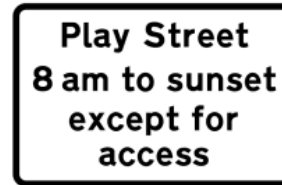

618

All vehicles prohibited from "Play Street" during the period indicated except for access

(37.5)  
50  
(62.5)

Item	
1	Regulations: None
2	Directions: 7, 8, 20(1), 21(1)
3	Diagrams: 617
4	Permitted variants: Schedule 16, item 38
5	Illumination requirements: Schedule 17, item 8



(37.5)  
50  
(62.5)  
(75)  
(100)

618.1

All vehicles prohibited during the period indicated except for access

Item	
1	Regulations: 22
2	Directions: 7, 8, 20(1), 21(1)
3	Diagrams: 617
4	Permitted variants: Schedule 16, item 38 "except for access" may be omitted. "for access" may be varied to: 1. "for loading" 2. "for loading by" with the goods vehicle symbol shown in diagram 618.2 3. "permit holders" and an identification symbol where appropriate 4. the blue badge symbol shown in diagram 661A 5. "buses" 6. "local buses" 7. "taxis" 8. "for access to off-street premises" These variants may be used in any combination with each other and with "for access", except that 1 and 2 shall not be used together or with "for access", 8 shall not be used with "for access", and 5 and 6 shall not be used together. The word "and" shall be inserted before the last variant where more than one is used
5	Illumination requirements: Schedule 17, item 8

**Status:** This is the original version (as it was originally made). This item of legislation is currently only available in its original format.

SCHEDULE 2 REGULATORY SIGNS (contd.)

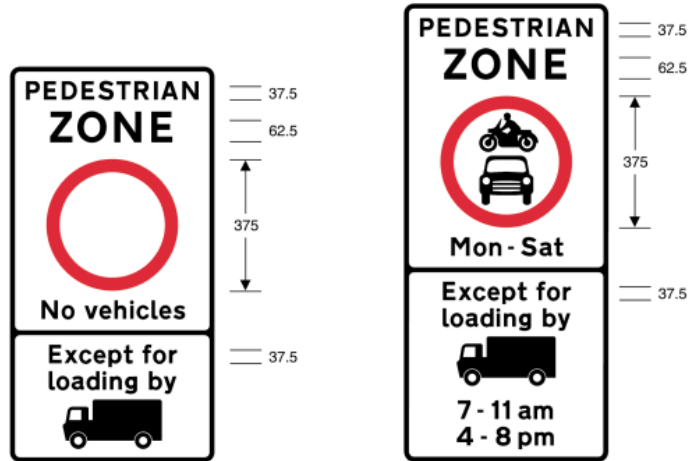

618.2  
Entry to pedestrian zone restricted  
(Alternative types)

Item	
1	Regulations: 22
2	Directions: 7, 8
3	Diagrams: None
4	<p>Permitted variants: Schedule 16, item 38 "for loading by" with the goods vehicle symbol may be varied to:</p> <ol style="list-style-type: none"> <li>1. "local buses"</li> <li>2. "buses"</li> <li>3. the blue badge symbol shown in diagram 661A</li> <li>4. "permit holders" and an identification symbol where appropriate</li> </ol> <p>These variants may be used in any combination with each other and with "for loading by" with the goods vehicle symbol, except that 1 and 2 shall not be used together. The word "and" shall be inserted before the last variant where more than one is used. The lower panel may be omitted</p>
5	Illumination requirements: Schedule 17, item 1

**Status:** This is the original version (as it was originally made). This item of legislation is currently only available in its original format.

SCHEDULE 2 REGULATORY SIGNS (contd.)

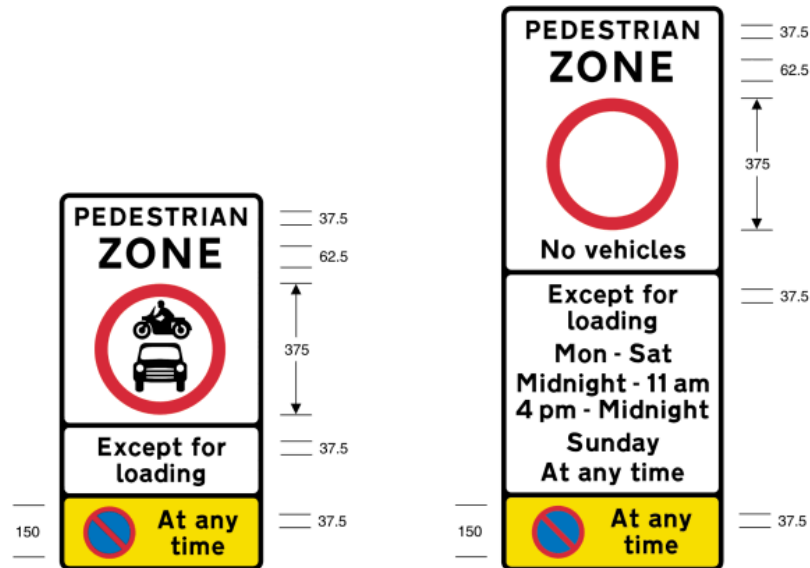

618.3  
Entry to and waiting in pedestrian zone restricted  
(Alternative types)

Item	
1	Regulations: 22
2	Directions: 7, 8, 24(3)
3	Diagrams: 637.2
4	Permitted variants: Schedule 16, item 38 "for loading" may be varied to: 1. "for loading by" with the goods vehicle symbol shown in diagram 618.2 2. "permit holders" and an identification symbol where appropriate 3. the blue badge symbol shown in diagram 661A 4. "buses" 5. "local buses" 6. "taxis" These variants may be used in any combination with each other and with "for loading", except that 1 shall not be used with "for loading", and 4 and 5 shall not be used together. The word "and" shall be inserted before the last variant where more than one is used
5	Illumination requirements: Schedule 17, item 1

*Status: This is the original version (as it was originally made). This item of legislation is currently only available in its original format.*

SCHEDULE 2 REGULATORY SIGNS (contd.)

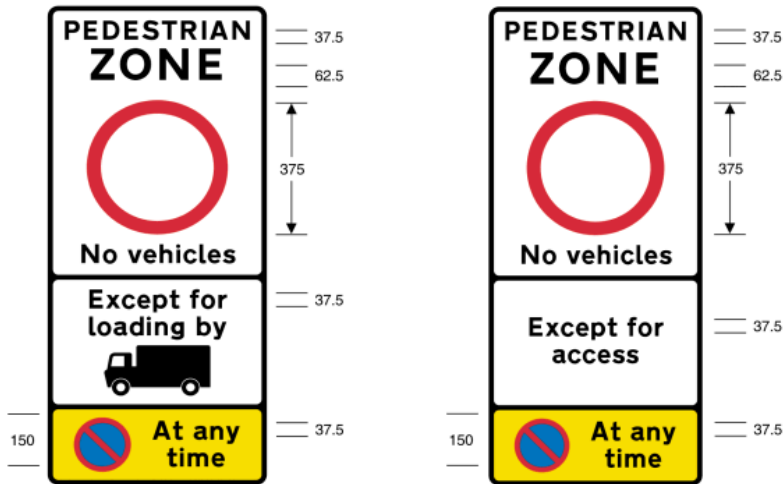

618.3A

Entry to and waiting in pedestrian zone restricted  
(Variable message sign)

Item	
1	Regulations: 22
2	Directions: 7, 8, 24(3), 56
3	Diagrams: 637.2
4	<p>Permitted variants: Schedule 16, item 38 (in respect of the bottom panel)</p> <p>The diagram 617 symbol may be varied to a diagram 619 symbol in which case the words "No vehicles" shall be omitted.</p> <p>"for loading by" and the goods vehicle symbol may be varied to:</p> <ol style="list-style-type: none"> <li>1. "for loading"</li> <li>2. "permit holders" and an identification symbol where appropriate</li> <li>3. the blue badge symbol shown in diagram 661A</li> <li>4. "buses"</li> <li>5. "local buses"</li> <li>6. "taxis"</li> </ol> <p>These variants may be used in any combination with each other and with "for loading by" and the goods vehicle symbol, except that 1 shall not be used with "for loading by" and the goods vehicle symbol, and 4 and 5 shall not be used together. The word "and" shall be inserted before the last variant where more than one is used. The words "Except for access" in the right hand version of the diagram may be omitted or variants 2 to 6 in any combination, except 4 and 5 together, and the word "and" may be inserted before the words "for access"</p>
5	Illumination requirements: Schedule 17, item 1

**Status:** This is the original version (as it was originally made). This item of legislation is currently only available in its original format.

SCHEDULE 2 REGULATORY SIGNS (contd.)

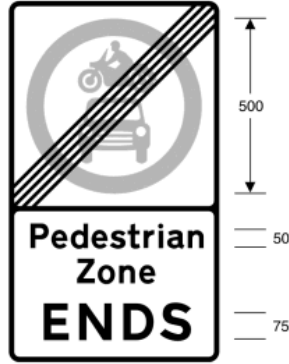

618.4  
End of restrictions associated with a pedestrian zone

Item	
1	Regulations: None
2	Directions: 7, 10(1)
3	Diagrams: None
4	Permitted variants: The diagram 619 symbol may be varied to a grey symbol of diagram 617
5	Illumination requirements: Schedule 17, item 1

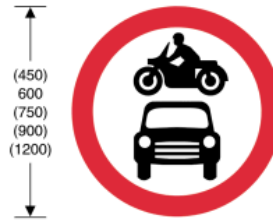

619  
Motor vehicles prohibited

Item	
1	Regulations: None
2	Directions: 7, 8, 21(1)
3	Diagrams: 620, 620.1
4	Permitted variants: None
5	Illumination requirements: Schedule 17, item 1

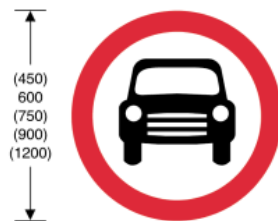

619.1  
Motor vehicles except solo motor cycles prohibited

Item	
1	Regulations: None
2	Directions: 7, 8, 21(1)
3	Diagrams: 620, 620.1
4	Permitted variants: None
5	Illumination requirements: Schedule 17, item 1

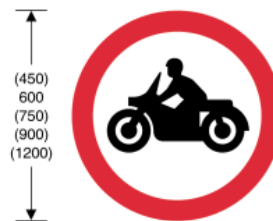

619.2  
Solo motor cycles prohibited

Item	
1	Regulations: None
2	Directions: 7, 8, 21(1)
3	Diagrams: 620
4	Permitted variants: None
5	Illumination requirements: Schedule 17, item 1

*Status: This is the original version (as it was originally made). This item of legislation is currently only available in its original format.*

SCHEDULE 2 REGULATORY SIGNS (contd.)

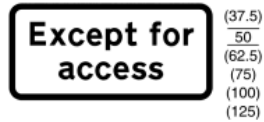

(37.5)  
50  
(62.5)  
(75)  
(100)  
(125)

620  
Vehicles requiring access to premises or land adjacent to the road are exempted from the prohibition conveyed by the associated sign

Item	
1	Regulations: 22
2	Directions: 7, 8, 21(1)
3	Diagrams: 619, 619.1, 619.2, 622.1A, 622.5, 622.6, 622.7, 622.8, 629, 629A, 629.1, 952
4	Permitted variants: Schedule 16, item 38 Same as diagram 618.1. "Except" shall be varied to "except" when preceded by a time period
5	Illumination requirements: Schedule 17, item 8



(37.5)  
50  
(62.5)  
(75)  
(100)  
(125)

620.1  
Goods vehicles requiring to enter the road for loading or unloading of goods exempted from the prohibition conveyed by the associated sign

Item	
1	Regulations: None
2	Directions: 7, 8, 21(1)
3	Diagrams: 619, 619.1
4	Permitted variants: Schedule 16, item 38
5	Illumination requirements: Schedule 17, item 8

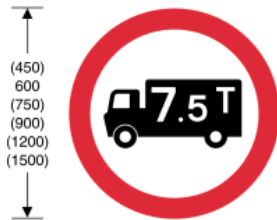

(450)  
600  
(750)  
(900)  
(1200)  
(1500)

622.1A  
Goods vehicles exceeding the maximum gross weight indicated on the goods vehicle symbol prohibited

Item	
1	Regulations: None
2	Directions: 7, 8, 21(1)
3	Diagrams: 554.3, 620
4	Permitted variants: "7.5T" may be varied to "18T"
5	Illumination requirements: Schedule 17, item 1



(450)  
600  
(750)  
(900)

622.2  
End of prohibition of goods vehicles exceeding the maximum gross weight indicated by signs to diagram 622.1A

Item	
1	Regulations: None
2	Directions: 7, 10(1)
3	Diagrams: None
4	Permitted variants: None
5	Illumination requirements: Schedule 17, item 1



**Status:** This is the original version (as it was originally made). This item of legislation is currently only available in its original format.

SCHEDULE 2 REGULATORY SIGNS (contd.)

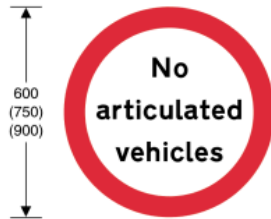

622.4  
Articulated vehicles prohibited

Item	
1	Regulations: None
2	Directions: 7, 8, 21(1)
3	Diagrams: 554.3
4	Permitted variants: "No articulated vehicles" may be varied to "No track laying vehicles"
5	Illumination requirements: Schedule 17, item 1

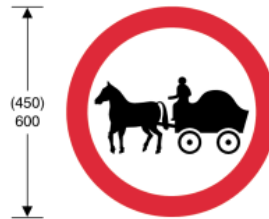

622.5  
Horse drawn vehicles prohibited

Item	
1	Regulations: None
2	Directions: 7, 8, 21(1)
3	Diagrams: 620
4	Permitted variants: None
5	Illumination requirements: Schedule 17, item 9



622.6  
Ridden or accompanied horses prohibited

Item	
1	Regulations: None
2	Directions: 7, 8, 21(1)
3	Diagrams: 620
4	Permitted variants: None
5	Illumination requirements: Schedule 17, item 9

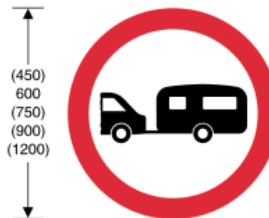

622.7  
Towed caravans prohibited

Item	
1	Regulations: None
2	Directions: 7, 8, 21(1)
3	Diagrams: 620
4	Permitted variants: None
5	Illumination requirements: Schedule 17, item 1

**Status:** This is the original version (as it was originally made). This item of legislation is currently only available in its original format.

SCHEDULE 2 REGULATORY SIGNS (contd.)

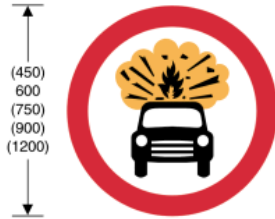

(450)  
600  
(750)  
(900)  
(1200)

622.8  
Vehicles carrying explosives prohibited

Item	
1	Regulations: None
2	Directions: 7, 8, 20(1), 21(1)
3	Diagrams: 620, 622.9
4	Permitted variants: None
5	Illumination requirements: Schedule 17, item 1



(37.5)  
50  
(62.5)  
(75)  
(100)  
(125)

622.9  
Same as diagram 622.8

Item	
1	Regulations: None
2	Directions: 7, 8, 20(1), 21(1)
3	Diagrams: 622.8
4	Permitted variants: "No explosives" may be varied to "No inflammables or explosives"
5	Illumination requirements: Schedule 17, item 8



(300)  
(450)  
600

625.1  
Pedestrians prohibited

Item	
1	Regulations: None
2	Directions: 7, 8
3	Diagrams: None
4	Permitted variants: None
5	Illumination requirements: Schedule 17, item 9

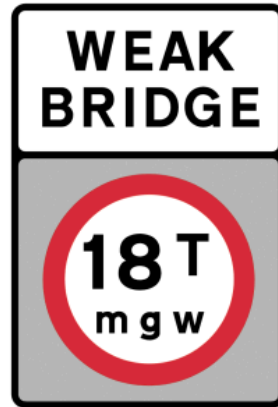

(60)  
80  
(100)  
(120)

(450)  
600  
(750)  
(900)

626.2A  
Vehicles exceeding the maximum gross weight indicated prohibited from crossing the bridge or other structure

Item	
1	Regulations: 10(1)
2	Directions: 7, 8, 21(1)
3	Diagrams: 627.1
4	Permitted variants: "18T" may be varied to "3T", "7.5T", "10T", "13T", "26T" or "33T" "BRIDGE" may be varied to "ROAD"
5	Illumination requirements: Schedule 17, item 1

**Status:** This is the original version (as it was originally made). This item of legislation is currently only available in its original format.

SCHEDULE 2 REGULATORY SIGNS (contd.)

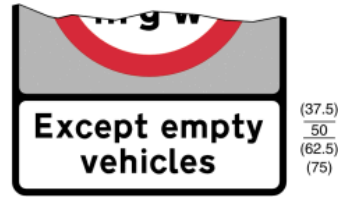

627.1  
Exemption for unladen vehicles from the prohibition conveyed by the sign in diagram 626.2A

Item	
1	Regulations: None
2	Directions: 7, 8, 21(1)
3	Diagrams: 626.2A
4	Permitted variants: None
5	Illumination requirements: Schedule 17, item 1

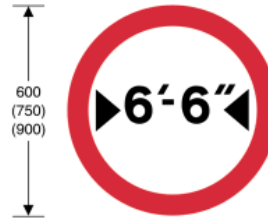

629  
Vehicles exceeding width indicated prohibited

Item	
1	Regulations: None
2	Directions: 7, 8, 21(1)
3	Diagrams: 554.3, 620, 954, 954.2
4	Permitted variants: Schedule 16, item 1
5	Illumination requirements: Schedule 17, item 1

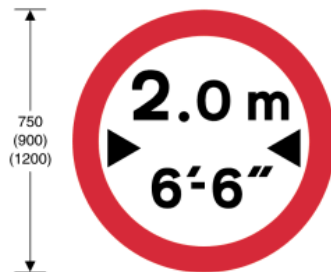

629A  
As diagram 629, with width indicated in both metric and imperial units

Item	
1	Regulations: None
2	Directions: 7, 8, 21(1)
3	Diagrams: 554.3, 620, 954, 954.2
4	Permitted variants: Schedule 16, item 1
5	Illumination requirements: Schedule 17, item 1

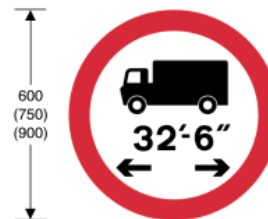

629.1  
Vehicles or combinations of vehicles exceeding length indicated prohibited

Item	
1	Regulations: None
2	Directions: 7, 8, 21(1), 40
3	Diagrams: 554.3, 620, 954, 954.2
4	Permitted variants: Schedule 16, items 1, 2
5	Illumination requirements: Schedule 17, item 1

*Status: This is the original version (as it was originally made). This item of legislation is currently only available in its original format.*

SCHEDULE 2 REGULATORY SIGNS (contd.)

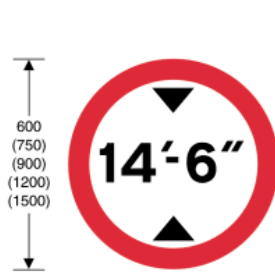

629.2  
Vehicles exceeding height indicated prohibited

Item	
1	Regulations: 10(1), 10(2)
2	Directions: 7, 8, 21(1)
3	Diagrams: 530.2
4	Permitted variants: Schedule 16, item 1
5	Illumination requirements: Schedule 17, item 1

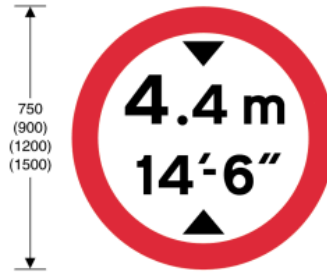

629.2A  
As diagram 629.2, with height indicated in both metric and imperial units

Item	
1	Regulations: 10(1), 10(2)
2	Directions: 7, 8, 21(1)
3	Diagrams: 530.2
4	Permitted variants: Schedule 16, item 1
5	Illumination requirements: Schedule 17, item 1

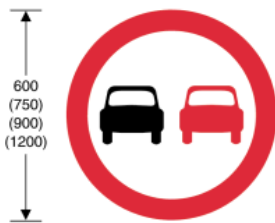

632  
No overtaking

Item	
1	Regulations: None
2	Directions: 7, 8, 11, 21(1)
3	Diagrams: 554.3, 570, 645
4	Permitted variants: None
5	Illumination requirements: Schedule 17, item 1



633  
Vehicular traffic must not proceed beyond the sign where displayed temporarily by a constable in uniform or by a traffic warden

Item	
1	Regulations: 54
2	Directions: 39(4)
3	Diagrams: None
4	Permitted variants: A red or transparent protective strip, with a visible width not exceeding 6 millimetres, may be applied to the perimeter of the sign
5	Illumination requirements: Schedule 17, item 4

**Status:** This is the original version (as it was originally made). This item of legislation is currently only available in its original format.

SCHEDULE 2 REGULATORY SIGNS (contd.)



636  
Temporary prohibition of waiting except for loading and unloading

Item	
1	Regulations: None
2	Directions: 7, 11
3	Diagrams: 636.1
4	Permitted variants: Schedule 16, item 11 Name of the police force or traffic authority, or the word "Police" or "POLICE" may be added above or below the roundel
5	Illumination requirements: Schedule 17, item 9



636.1  
Temporary prohibition of loading and unloading

Item	
1	Regulations: None
2	Directions: 7, 11
3	Diagrams: 636
4	Permitted variants: The legend may be on one line
5	Illumination requirements: Schedule 17, item 9

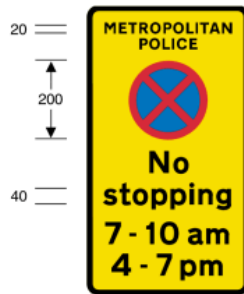

636.2  
Temporary prohibition on stopping during the periods indicated

Item	
1	Regulations: None
2	Directions: 7, 11, 39(4)
3	Diagrams: None
4	Permitted variants: Schedule 16, item 38 The name of the police force may be varied to the appropriate force, "POLICE" or "Police", the name of a traffic authority, or omitted. "No stopping" may be on one line
5	Illumination requirements: Schedule 17, item 9



637.1  
Continuous prohibition on waiting except loading and unloading on verge or footway

Item	
1	Regulations: None
2	Directions: 7, 11
3	Diagrams: None
4	Permitted variants: Schedule 16, item 11 The sign shown in diagram 642 may be substituted for the symbol of the sign shown in diagram 636. The words "verge or" or "or footway" may be omitted
5	Illumination requirements: Schedule 17, item 9

*Status: This is the original version (as it was originally made). This item of legislation is currently only available in its original format.*

SCHEDULE 2 REGULATORY SIGNS (contd.)

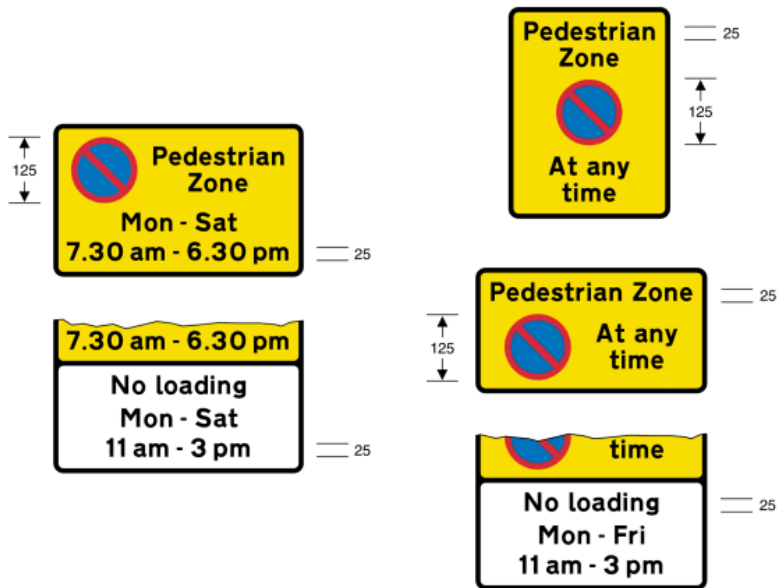

637.2  
Prohibition on waiting (and loading and unloading)  
in a pedestrian zone  
(Alternative types)

Item	
1	Regulations: None
2	Directions: 7, 11, 24(3), 24(4), 25
3	Diagrams: 618.3, 618.3A, 1017, 1018.1, 1019, 1020.1
4	Permitted variants: Schedule 16, item 38 The panels indicating the prohibition of loading and unloading may be varied to diagram 638
5	Illumination requirements: Schedule 17, item 9

**Status:** This is the original version (as it was originally made). This item of legislation is currently only available in its original format.

SCHEDULE 2 REGULATORY SIGNS (contd.)



637.3  
Continuous prohibition on waiting except for loading and unloading for at least 4 consecutive months

Item	
1	Regulations: None
2	Directions: 7, 11, 24(1), 24(2)
3	Diagrams: 1018.1
4	Permitted variants: Schedule 16, item 11 "1 May - 30 Sept" may be varied to any period of not less than 4 consecutive months
5	Illumination requirements: Schedule 17, item 9



638  
Continuous prohibition on loading and unloading

Item	
1	Regulations: None
2	Directions: 7, 11, 24(1), 25
3	Diagrams: 1020.1
4	Permitted variants: Schedule 16, item 11
5	Illumination requirements: Schedule 17, item 9



638.1  
Loading and unloading prohibited during the periods and in the direction indicated

Item	
1	Regulations: None
2	Directions: 7, 11, 24(1), 25
3	Diagrams: 1019
4	Permitted variants: Schedule 16, items 13, 14, 38
5	Illumination requirements: Schedule 17, item 9



639  
Waiting prohibited except for loading and unloading during the period and in the direction indicated

Item	
1	Regulations: None
2	Directions: 7, 11, 24(1), 24(2), 25
3	Diagrams: 1017
4	Permitted variants: Schedule 16, items 13, 14, 38 The relative positions of the "no waiting" symbol and other legend may be as shown in the upper panel of either diagram 639.1B or 640
5	Illumination requirements: Schedule 17, item 9

**Status:** This is the original version (as it was originally made). This item of legislation is currently only available in its original format.

SCHEDULE 2 REGULATORY SIGNS (contd.)



639.1B

Waiting prohibited during the periods indicated on the upper panel and restrictions on waiting during the period indicated on the lower panel

Item	
1	Regulations: 24
2	Directions: 7, 11, 24(1), 25
3	Diagrams: 661.4, 857.1, 1017, 1019, 1028.3, 1028.4, 1032, 1033
4	Permitted variants: Schedule 16, items 11, 38, 39 The relative positions of the "no waiting" symbol and other legend in the upper panel may be as shown in diagram 639 or in the upper panel of diagram 640. The upper panel may be varied to diagram 650.2 or 650.3. The lower panel may be varied in a similar manner to diagram 661.1 or varied to diagram 660, 660.3, 660.4, 660.5, 660.6, 660.7, 661A, 661.2A, 661.3A or 662. The sign shown in diagram 638.1 may be added as a middle panel with the size of the legend as shown for diagram 639.1B
5	Illumination requirements: Schedule 17, item 9

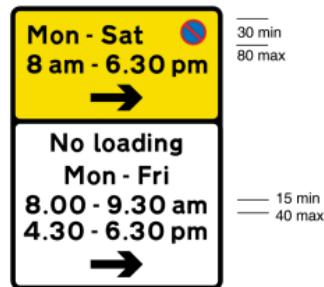

640

Waiting prohibited during the period and in the direction indicated on the upper panel and loading and unloading prohibited during the periods and in the direction indicated on the lower panel

Item	
1	Regulations: None
2	Directions: 7, 11, 24(1), 24(2), 25
3	Diagrams: 1017, 1018.1, 1019, 1020.1, 1028.2
4	Permitted variants: Schedule 16, items 13, 14, 38 The relative positions of the "no waiting" symbol and other legend in the upper panel may be as shown in diagram 639 or in the upper panel of diagram 639.1B. The upper panel may be varied to diagram 637.3 or 650.3 with the size of the symbol and legend as shown for diagram 640. The lower panel may be varied to diagram 638 with the size of the legend as shown for diagram 640
5	Illumination requirements: Schedule 17, item 9



**Status:** This is the original version (as it was originally made). This item of legislation is currently only available in its original format.

SCHEDULE 2 REGULATORY SIGNS (contd.)

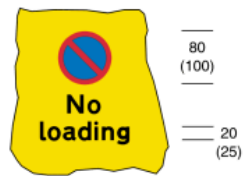

640.1  
Waiting, loading and unloading prohibited at a parking place where parking is temporarily suspended (Indication on parking meter cover)

Item	
1	Regulations: None
2	Directions: None
3	Diagrams: None
4	Permitted variants: "during meter control" may be added. "No loading" may be omitted
5	Illumination requirements: Schedule 17, item 9

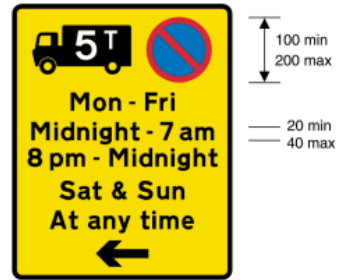

640.2A  
Waiting by goods vehicles over maximum gross weight shown prohibited during the periods and in the direction indicated

Item	
1	Regulations: 4, 24
2	Directions: 7
3	Diagrams: None
4	Permitted variants: Schedule 16, items 13, 14, 38 "5T" may be varied to "7.5T". The bus symbol shown in diagram 952 may be added below or substituted for the lorry symbol. When the arrow points to the right the relative positions of the lorry or bus symbol and the no waiting roundel shall be reversed and the lorry or bus symbol (with a window substituted for the door) shall face to the right
5	Illumination requirements: Schedule 17, item 9

*Status: This is the original version (as it was originally made). This item of legislation is currently only available in its original format.*

SCHEDULE 2 REGULATORY SIGNS (contd.)



640.3  
Entrance to a designated off-highway loading area in which waiting restrictions apply

Item	
1	Regulations: None
2	Directions: 7
3	Diagrams: None
4	Permitted variants: Schedule 16, item 38
5	Illumination requirements: Schedule 17, item 9



640.4  
Waiting prohibited in a designated off-highway loading area during the period indicated except by permitted vehicles

Item	
1	Regulations: None
2	Directions: 7
3	Diagrams: None
4	Permitted variants: Schedule 16, item 38
5	Illumination requirements: Schedule 17, item 9



640.5  
End of designated off-highway loading area in which waiting restrictions apply

Item	
1	Regulations: None
2	Directions: 7
3	Diagrams: None
4	Permitted variants: None
5	Illumination requirements: Schedule 17, item 9

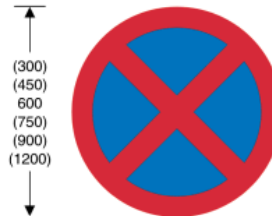

642  
No stopping on main carriageway

Item	
1	Regulations: 12(7)
2	Directions: 7, 8, 11, 21(1)
3	Diagrams: 570, 645
4	Permitted variants: None
5	Illumination requirements: Schedule 17, items 1, 4

**Status:** This is the original version (as it was originally made). This item of legislation is currently only available in its original format.

SCHEDULE 2 REGULATORY SIGNS (contd.)



642.2A  
No stopping on the road marking shown in diagram 1027.1 during the period indicated

Item	
1	Regulations: None
2	Directions: 7, 22(3), 24(1)
3	Diagrams: 1027.1
4	Permitted variants: Schedule 16, item 38 The "no stopping" symbol may be placed centrally above the top line of legend
5	Illumination requirements: Schedule 17, item 4



642.3  
No stopping in lay-by except in emergency

Item	
1	Regulations: None
2	Directions: 7, 24(1)
3	Diagrams: 1018.1, 2713.1, 2714, 2715
4	Permitted variants: None
5	Illumination requirements: Schedule 17, item 4

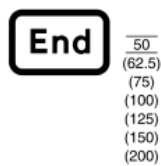

645  
End of restriction or prohibition conveyed by associated sign or, when used with the sign shown in diagram 7001, end of all restrictions or prohibitions associated with road works

Item	
1	Regulations: 12(7)
2	Directions: 10(1), 10(3), 20(1), 21(1)
3	Diagrams: 614, 615, 632, 642, 811, 7001
4	Permitted variants: None
5	Illumination requirements: Schedule 17, item 8

**Status:** This is the original version (as it was originally made). This item of legislation is currently only available in its original format.

SCHEDULE 2 REGULATORY SIGNS (contd.)

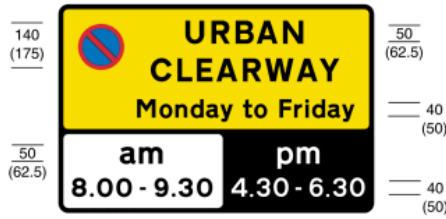

646  
No stopping during periods indicated except for so long as may be necessary for the purpose of picking up or setting down passengers

Item	
1	Regulations: None
2	Directions: 7, 8, 11
3	Diagrams: None
4	Permitted variants: Schedule 16, item 38
5	Illumination requirements: Schedule 17, item 4



647  
End of restriction on stopping

Item	
1	Regulations: None
2	Directions: 7, 10(1)
3	Diagrams: None
4	Permitted variants: None
5	Illumination requirements: Schedule 17, item 4



650.1  
Prohibition on stopping by vehicles other than taxis during the period indicated

Item	
1	Regulations: None
2	Directions: 7, 11, 24(1), 24(2), 25
3	Diagrams: 857.1, 1028.2
4	Permitted variants: Schedule 16, items 11, 38 "taxis" may be varied to "ambulances" or "police vehicles"
5	Illumination requirements: Schedule 17, item 4

**Status:** This is the original version (as it was originally made). This item of legislation is currently only available in its original format.

SCHEDULE 2 REGULATORY SIGNS (contd.)



650.2  
Prohibition on waiting by vehicles other than taxis during the period indicated

Item	
1	Regulations: None
2	Directions: 7, 11, 24(1), 25
3	Diagrams: 857.1, 1028.2
4	Permitted variants: Schedule 16, items 11, 38 Same as diagram 650.1
5	Illumination requirements: Schedule 17, item 9



650.3  
Continuous prohibition on waiting by vehicles with an exemption for taxis during the period indicated

Item	
1	Regulations: None
2	Directions: 7, 11, 24(1), 25
3	Diagrams: 857.1, 1017, 1018.1, 1028.2
4	Permitted variants: Schedule 16, items 11, 38 Same as diagram 650.1. Where "At any time" is varied to another time of day, the relative positions of the "no waiting" symbol and legend may be as shown in the upper panel of either diagram 639.1B or 640
5	Illumination requirements: Schedule 17, item 9



651  
Use of verge maintained in mown or ornamental condition by specified traffic prohibited

Item	
1	Regulations: None
2	Directions: 7, 42(1), 42(4)
3	Diagrams: None
4	Permitted variants: Schedule 16, item 11 The word "animals" or the diagram 625.1 symbol and the word "pedestrians" may be omitted, or this symbol and both these words may be omitted
5	Illumination requirements: Schedule 17, item 9

**Status:** This is the original version (as it was originally made). This item of legislation is currently only available in its original format.

SCHEDULE 2 REGULATORY SIGNS (contd.)



652  
One-way traffic

Item	
1	Regulations: None
2	Directions: 7
3	Diagrams: None
4	Permitted variants: None
5	Illumination requirements: Schedule 17, item 1



660  
Parking place reserved for permit holders

Item	
1	Regulations: None
2	Directions: 7, 11, 24(1), 25
3	Diagrams: 1028.3, 1028.4, 1032, 1033
4	Permitted variants: Schedule 16, items 11, 38, 39 "Permit holders only" may be varied to: 1. "Card holders only" 2. "Doctor permit holders only" 3. "Large or slow vehicles only" 4. "Business permit holders only" 5. "Resident permit holders only"
5	Illumination requirements: Schedule 17, item 9



660.3  
Parking place reserved for holders of residents' permits

Item	
1	Regulations: None
2	Directions: 7, 11, 24(1), 25
3	Diagrams: 1028.4, 1032, 1033
4	Permitted variants: Schedule 16, items 11, 38, 39 "Resident permit holders only" may be varied to: 1. "Permit holders only" 2. "Doctor permit holders only" 3. "Business permit holders only"
5	Illumination requirements: Schedule 17, item 9

**Status:** This is the original version (as it was originally made). This item of legislation is currently only available in its original format.

SCHEDULE 2 REGULATORY SIGNS (contd.)



660.4  
Part of the carriageway reserved  
for loading and unloading

Item	
1	Regulations: None
2	Directions: 7, 11, 24(1), 25
3	Diagrams: 1028.3, 1032, 1033
4	Permitted variants: Schedule 16, items 11, 28, 38, 39 "Loading only" may be varied to "Goods vehicles loading only"
5	Illumination requirements: Schedule 17, item 9

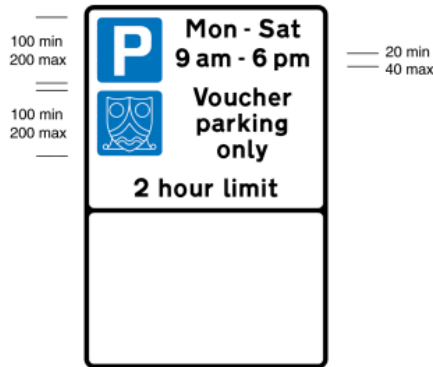

660.5  
Parking place reserved for voucher parking  
during the period indicated

Item	
1	Regulations: None
2	Directions: 7, 11, 24(1), 25
3	Diagrams: 1028.4, 1032, 1033
4	Permitted variants: Schedule 16, items 11, 38, 39 The words "and resident permits", "and business permits" or "and permits" may be inserted after "Voucher parking". The voucher parking symbol is to be varied to correspond with the design on the approved voucher within the size shown. Information on the voucher parking scheme may be shown in the lower panel. The lower panel may be omitted
5	Illumination requirements: Schedule 17, item 9

*Status: This is the original version (as it was originally made). This item of legislation is currently only available in its original format.*

SCHEDULE 2 REGULATORY SIGNS (contd.)

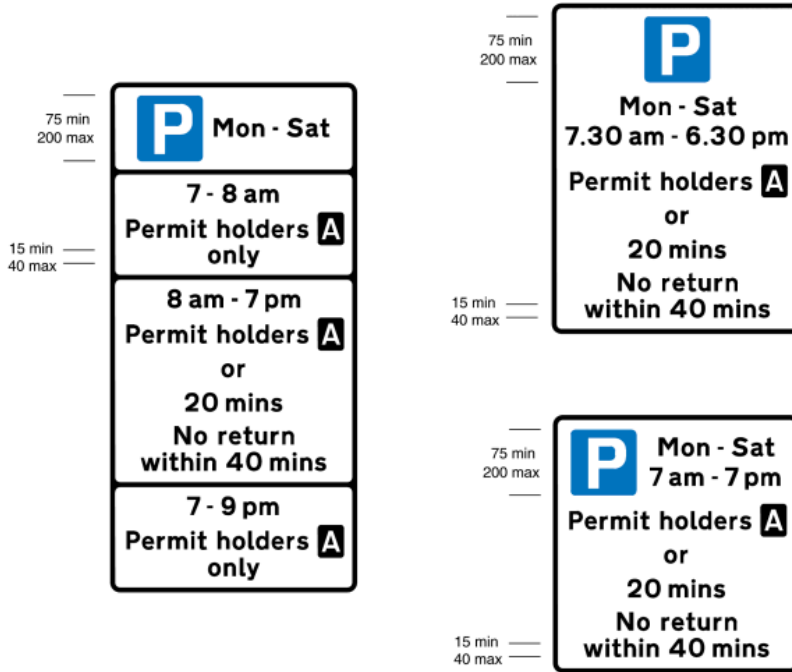

660.6

Parking place for permit holders with limited waiting permitted by others at specified times (Alternative types)

Item	
1	Regulations: None
2	Directions: 7, 11, 24(1), 25
3	Diagrams: 1028.4, 1032, 1033
4	Permitted variants: Schedule 16, items 11, 38, 39 "Permit holders" may be varied to "Resident permit holders", "Business permit holders", "Doctor permit holders" or "Card holders". The number of panels in the left hand diagram may be varied. Each panel in the left hand diagram, other than the top panel, shall be in the form shown in the second or third panels from the top. In the third panel from the top, the legend "Permit holders A or" may be omitted. Where the "P" symbol only is shown in the top panel of the left hand diagram, it shall be centred horizontally on the sign
5	Illumination requirements: Schedule 17, item 9



**Status:** This is the original version (as it was originally made). This item of legislation is currently only available in its original format.

SCHEDULE 2 REGULATORY SIGNS (contd.)

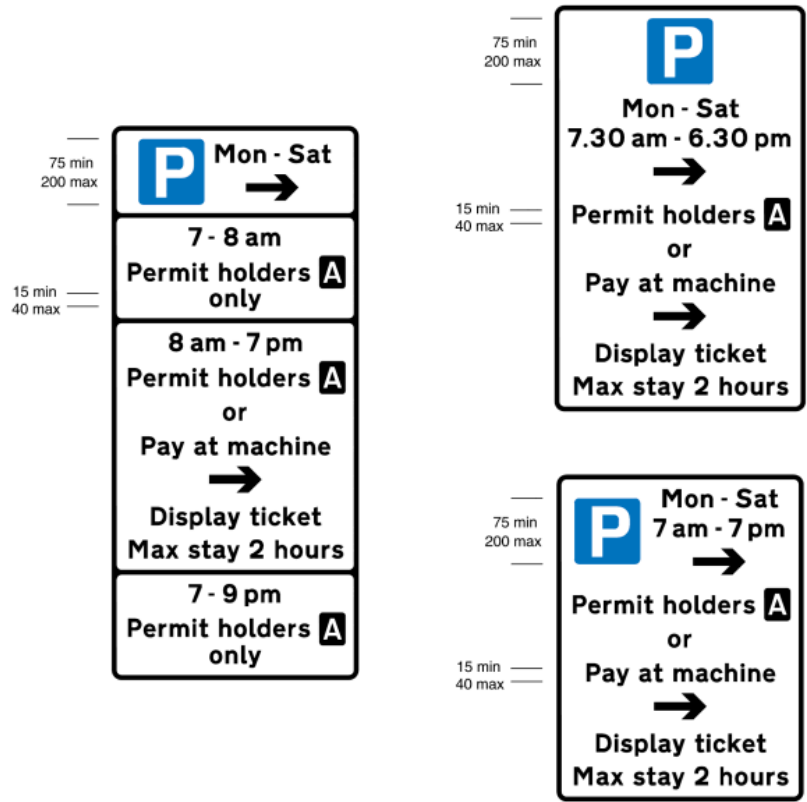

660.7

Parking place for permit holders with paid limited waiting permitted by others at specified times (Alternative types)

Item	
1	Regulations: None
2	Directions: 7, 24(1), 25
3	Diagrams: 661.4, 1028.4, 1032, 1033
4	Permitted variants: Schedule 16, items 13, 14, 38, 39 Same as diagram 660.6. The arrow below the legend "Pay at machine" may be replaced by the legend "across road" or "opposite", or, when the arrow at the top of the sign is omitted, replaced by two horizontal arrows pointing in opposite directions
5	Illumination requirements: Schedule 17, item 9

*Status: This is the original version (as it was originally made). This item of legislation is currently only available in its original format.*

SCHEDULE 2 REGULATORY SIGNS (contd.)



661A  
Parking place reserved for disabled badge holders

Item	
1	Regulations: None
2	Directions: 7, 11, 24(1), 25
3	Diagrams: 1028.3, 1032, 1033
4	Permitted variants: Schedule 16, items 11, 38, 39
5	Illumination requirements: Schedule 17, item 9



661.1  
Restrictions on length of waiting time and return period

Item	
1	Regulations: 24
2	Directions: 7, 11, 24(1), 25
3	Diagrams: 1028.3, 1028.4, 1032, 1033
4	Permitted variants: Schedule 16, items 11, 38, 39 The "P" symbol may be placed centrally above the top line of legend. The car symbol shown in diagram 804.2, the motor cycle symbol shown in diagram 804.4 or the bus symbol shown in diagram 952 may be added. When an arrow pointing to the right is added to the sign, the car, motor cycle or bus symbol (with a window substituted for the door) shall face to the right
5	Illumination requirements: Schedule 17, item 9



661.2A  
'Pay and Display' ticket-regulated parking place

Item	
1	Regulations: None
2	Directions: 7, 24(1), 25
3	Diagrams: 661.4, 1028.4, 1032, 1033
4	Permitted variants: Schedule 16, items 13, 38, 39 The arrow may be replaced by the legend "across road" or "opposite". A second arrow pointing in the opposite direction may be added
5	Illumination requirements: Schedule 17, item 9



661.3A  
Location of 'Pay and Display' ticket machine

Item	
1	Regulations: None
2	Directions: 7, 24(1), 25
3	Diagrams: 661.4, 1028.4, 1032, 1033
4	Permitted variants: Schedule 16, items 38, 39
5	Illumination requirements: Schedule 17, item 9

**Status:** This is the original version (as it was originally made). This item of legislation is currently only available in its original format.

SCHEDULE 2 REGULATORY SIGNS (contd.)



661.4  
Drivers must obtain and display parking tickets  
(Alternative types)

Item	
1	Regulations: None
2	Directions: 7
3	Diagrams: 639.1B, 660.7, 661.2A, 661.3A
4	Permitted variants: Schedule 16, item 39
5	Illumination requirements: Schedule 17, item 9



662  
Period during which waiting is limited and display  
of a disc is required at a parking place in a disc zone

Item	
1	Regulations: None
2	Directions: 7, 11, 24(1), 25
3	Diagrams: 1028.4, 1032, 1033
4	Permitted variants: Schedule 16, items 11, 38, 39 "Disc" may be varied to "Ticket"
5	Illumination requirements: Schedule 17, item 9

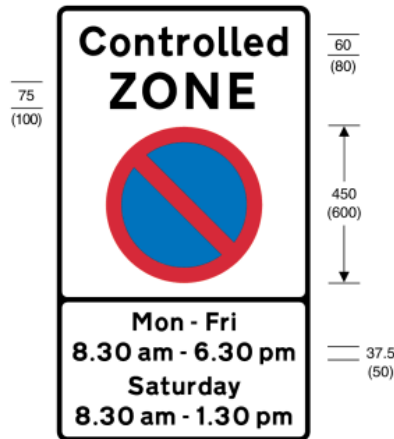

663  
Entrance to a controlled parking zone

Item	
1	Regulations: 4
2	Directions: 7, 8, 25(2), 26
3	Diagrams: 1017, 1018.1, 1019, 1020.1
4	Permitted variants: Schedule 16, items 38, 39 "Controlled" may be varied to: 1. "Meter" 2. "Disc" 3. "Ticket" 4. "Disc and Meter" 5. "Ticket and Meter" 6. "Pay and Display" The legend "No loading" may be added beneath the no waiting roundel. The lower panel shall be omitted where the restrictions apply at all times
5	Illumination requirements: Schedule 17, item 4

*Status: This is the original version (as it was originally made). This item of legislation is currently only available in its original format.*

SCHEDULE 2 REGULATORY SIGNS (contd.)

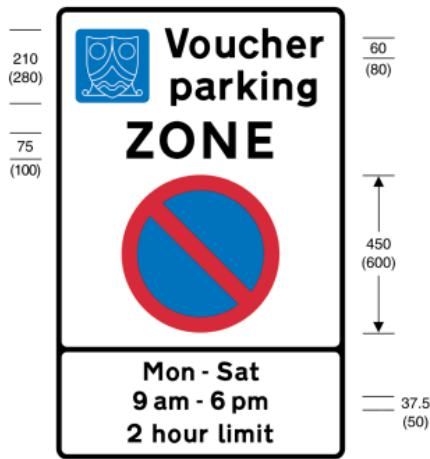

663.1  
Entrance to a voucher parking zone

Item	
1	Regulations: 4
2	Directions: 7, 8, 25(2), 26
3	Diagrams: 1017, 1018.1, 1019, 1020.1, 1028.4, 1032, 1033
4	Permitted variants: Schedule 16, items 38, 39 The voucher parking symbol is to be varied to correspond with the design on the approved voucher within the size shown. "Voucher parking" may be varied to "Voucher parking and Meter" or "Voucher parking and Ticket". "No loading" may be added below the no waiting roundel
5	Illumination requirements: Schedule 17, item 4

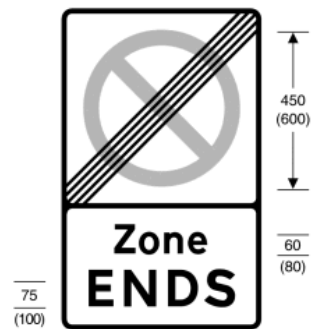

664  
End of controlled or voucher parking zone

Item	
1	Regulations: None
2	Directions: 7, 10(1), 26
3	Diagrams: None
4	Permitted variants: None
5	Illumination requirements: Schedule 17, item 4

**Status:** This is the original version (as it was originally made). This item of legislation is currently only available in its original format.

SCHEDULE 2 REGULATORY SIGNS (contd.)

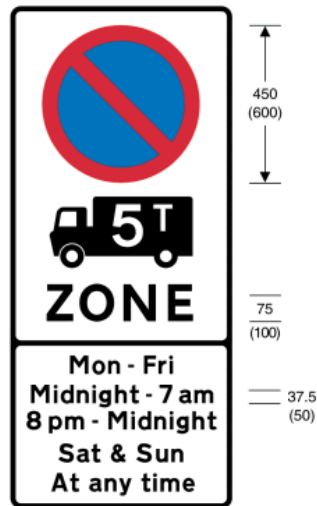

665  
Entrance to a controlled parking zone applying to goods vehicles over maximum gross weight shown

Item	
1	Regulations: 4, 24
2	Directions: 7, 8, 26
3	Diagrams: None
4	Permitted variants: Schedule 16, item 38 "5T" may be varied to "7.5T". The bus symbol shown in diagram 952 may be added below or substituted for the lorry symbol
5	Illumination requirements: Schedule 17, item 4

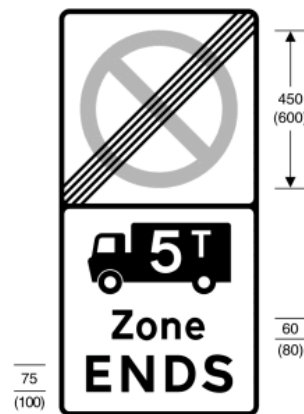

666  
End of a controlled parking zone applying to goods vehicles over maximum gross weight shown

Item	
1	Regulations: 24
2	Directions: 7, 10(1), 26
3	Diagrams: None
4	Permitted variants: "5T" may be varied to "7.5T". The bus symbol shown in diagram 952 may be added below or substituted for the lorry symbol
5	Illumination requirements: Schedule 17, item 4

**Status:** This is the original version (as it was originally made). This item of legislation is currently only available in its original format.

SCHEDULE 2 REGULATORY SIGNS (contd.)



667  
Vehicles may be parked partially on the verge or footway

Item	
1	Regulations: None
2	Directions: 7, 8, 25
3	Diagrams: 1028.4
4	Permitted variants: Schedule 16, item 11 The symbol of the car on the footway may be reversed in a mirror image
5	Illumination requirements: Schedule 17, item 9



667.1  
Vehicles may be parked partially on the verge or footway during the period indicated

Item	
1	Regulations: None
2	Directions: 7, 8, 25
3	Diagrams: 1028.4
4	Permitted variants: Schedule 16, items 11, 38 The symbol of the car on the footway may be reversed in a mirror image. "In marked bays" may be added to or substituted for the times shown in the lower panel
5	Illumination requirements: Schedule 17, item 9



667.2  
End of area where vehicles may be parked partially on the verge or footway

Item	
1	Regulations: None
2	Directions: 7, 10(1)
3	Diagrams: None
4	Permitted variants: Schedule 16, item 11 The symbol of the car on the footway may be reversed in a mirror image
5	Illumination requirements: Schedule 17, item 9

**Status:** This is the original version (as it was originally made). This item of legislation is currently only available in its original format.

SCHEDULE 2 REGULATORY SIGNS (contd.)



668  
Vehicles may be parked wholly on the verge or footway

Item	
1	Regulations: None
2	Directions: 7, 8, 25
3	Diagrams: 1028.4
4	Permitted variants: Schedule 16, item 11 The symbol of the car on the footway may be reversed in a mirror image
5	Illumination requirements: Schedule 17, item 9



668.1  
Vehicles may be parked wholly on the verge or footway during the period indicated

Item	
1	Regulations: None
2	Directions: 7, 8, 25
3	Diagrams: 1028.4
4	Permitted variants: Schedule 16, items 11, 38 The symbol of the car on the footway may be reversed in a mirror image. "In marked bays" may be added to or substituted for the times shown in the lower panel
5	Illumination requirements: Schedule 17, item 9



668.2  
End of area where vehicles may be parked wholly on the verge or footway

Item	
1	Regulations: None
2	Directions: 7, 10(1)
3	Diagrams: None
4	Permitted variants: Schedule 16, item 11 The symbol of the car on the footway may be reversed in a mirror image
5	Illumination requirements: Schedule 17, item 9

**Status:** This is the original version (as it was originally made). This item of legislation is currently only available in its original format.

SCHEDULE 2 REGULATORY SIGNS (contd.)

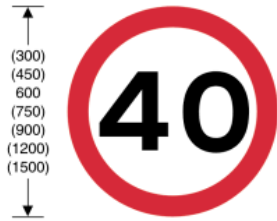

670  
Maximum speed limit in miles per hour

Item	
1	Regulations: 58(6), 58(7)
2	Directions: 7, 8, 9, 10(3), 11, 18(1)
3	Diagrams: 1065
4	Permitted variants: Schedule 16, item 1
5	Illumination requirements: Schedule 17, items 10, 11

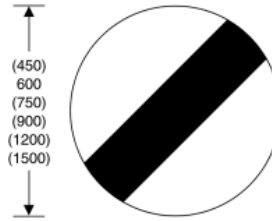

671  
National speed limits apply

Item	
1	Regulations: None
2	Directions: 7, 10, 11(5)
3	Diagrams: None
4	Permitted variants: None
5	Illumination requirements: Schedule 17, items 10, 11

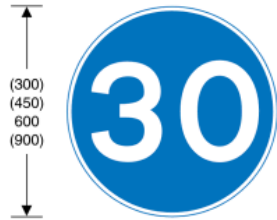

672  
Minimum speed limit in miles per hour

Item	
1	Regulations: None
2	Directions: 7, 8, 11
3	Diagrams: None
4	Permitted variants: Schedule 16, item 1
5	Illumination requirements: Schedule 17, items 10, 11

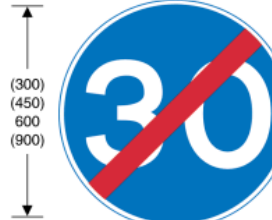

673  
End of a minimum speed limit

Item	
1	Regulations: None
2	Directions: 7, 10(1), 10(4)
3	Diagrams: None
4	Permitted variants: Schedule 16, item 1
5	Illumination requirements: Schedule 17, items 10, 11



**Status:** This is the original version (as it was originally made). This item of legislation is currently only available in its original format.

SCHEDULE 2 REGULATORY SIGNS (contd.)

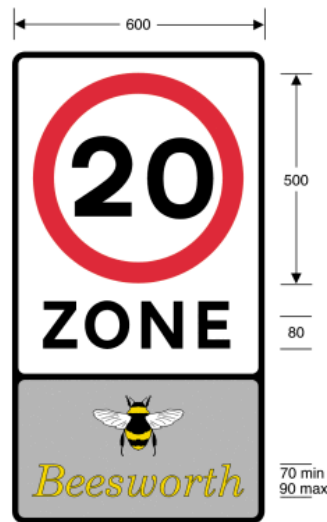

674  
Entrance to a 20 mph speed limit zone

Item	
1	Regulations: 13(2), 13(4)
2	Directions: 7, 8, 9, 11(3), 16, 18(1)
3	Diagrams: 1065
4	Permitted variants: Schedule 16, item 19 The place name may be omitted or varied to a road safety slogan. The bottom panel may be omitted. The symbol or pictogram may be varied or omitted. The place name may be in any style of lettering. Any contrasting colours except red may be used for the place name and the background of that part of the sign. Advertising material or political slogans must not be included on the sign
5	Illumination requirements: Schedule 17, item 11



675  
End of a 20 mph speed limit zone

Item	
1	Regulations: None
2	Directions: 7, 9, 10
3	Diagrams: None
4	Permitted variants: Schedule 16, item 1 The upper part of the sign may be replaced by a roundel in the form of diagram 671 against a grey background
5	Illumination requirements: Schedule 17, item 11

*Status: This is the original version (as it was originally made). This item of legislation is currently only available in its original format.*

### SCHEDULE 3

### SIGNS FOR RAILWAY AND TRAMWAY LEVEL CROSSINGS

#### SCHEDULE 3

Regulation 11(1)

#### SIGNS FOR RAILWAY AND TRAMWAY LEVEL CROSSINGS

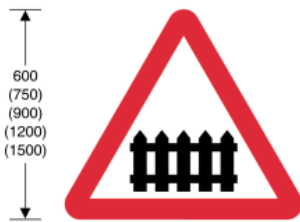

770  
Level crossing with gate or barrier ahead

Item	
1	Regulations: None
2	Directions: 21(1)
3	Diagrams: 572, 573, 773
4	Permitted variants: None
5	Illumination requirements: Schedule 17, item 1

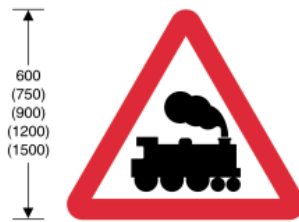

771  
Railway level crossing without gate or barrier ahead

Item	
1	Regulations: None
2	Directions: 21(1)
3	Diagrams: 572, 573, 773
4	Permitted variants: None
5	Illumination requirements: Schedule 17, item 1



772  
Tramcars crossing ahead

Item	
1	Regulations: None
2	Directions: 21(1)
3	Diagrams: 572, 573, 773
4	Permitted variants: None
5	Illumination requirements: Schedule 17, item 1

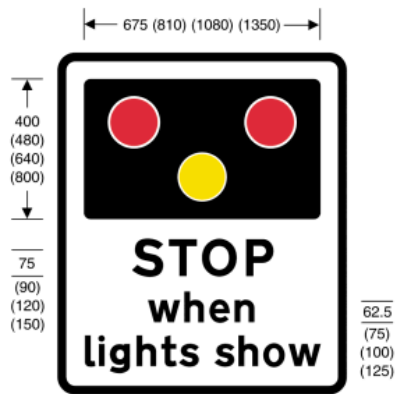

773  
Light signals as shown in diagram 3014 ahead

Item	
1	Regulations: None
2	Directions: 21(1)
3	Diagrams: 529, 529.1, 558, 770, 771, 772
4	Permitted variants: Schedule 16, items 3, 6, 11
5	Illumination requirements: Schedule 17, item 8

**Status:** This is the original version (as it was originally made). This item of legislation is currently only available in its original format.

SCHEDULE 3 SIGNS FOR RAILWAY AND TRAMWAY LEVEL CROSSINGS (contd.)

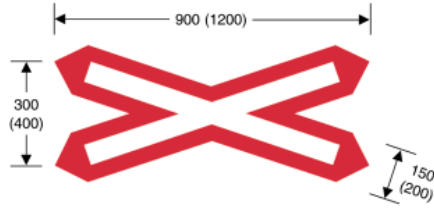

774  
Location of railway or tramway level crossing without gate or barrier

Item	
1	Regulations: None
2	Directions: None
3	Diagrams: 602 (when used with 778 or 778.1), 3014
4	Permitted variants: None
5	Illumination requirements: Schedule 17, item 4



775  
Vehicular traffic must not stop within the area of a railway or tramway level crossing

Item	
1	Regulations: None
2	Directions: None
3	Diagrams: 3014
4	Permitted variants: None
5	Illumination requirements: Schedule 17, item 4



776  
Another train or tramcar may be about to pass over the crossing

Item	
1	Regulations: 18(2)
2	Directions: 55(10), 56
3	Diagrams: 3014
4	Permitted variants: "TRAIN" may be varied to "TRAM"
5	Illumination requirements: Schedule 17, item 14



777  
Level crossing ahead is crossed by more than one railway or tramway track, and more than one train or tramcar may pass over it in quick succession

Item	
1	Regulations: None
2	Directions: None
3	Diagrams: 3014
4	Permitted variants: Same as diagram 776
5	Illumination requirements: Schedule 17, item 4

**Status:** This is the original version (as it was originally made). This item of legislation is currently only available in its original format.

SCHEDULE 3 SIGNS FOR RAILWAY AND TRAMWAY LEVEL CROSSINGS (contd.)

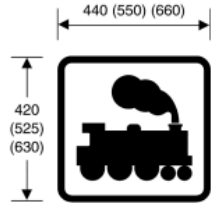

778  
Open railway level crossing without light signals

Item	
1	Regulations: 16, 25
2	Directions: 21(1)
3	Diagrams: 602
4	Permitted variants: None
5	Illumination requirements: Schedule 17, item 8

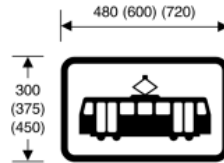

778.1  
Open tramway level crossing without light signals

Item	
1	Regulations: 16, 25
2	Directions: 21(1)
3	Diagrams: 602
4	Permitted variants: None
5	Illumination requirements: Schedule 17, item 8

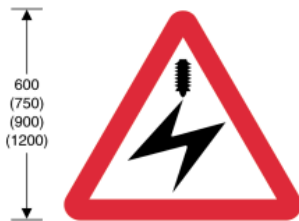

779  
Electrified overhead cable ahead

Item	
1	Regulations: None
2	Directions: 20(1), 21(1)
3	Diagrams: 780A, 780.1A, 780.2A
4	Permitted variants: None
5	Illumination requirements: Schedule 17, item 1



780A  
Safe height beneath electrified overhead cable ahead

Item	
1	Regulations: 17(5)
2	Directions: 20(1), 21(1)
3	Diagrams: 779
4	Permitted variants: Schedule 16, item 1 The indication of height in metric units may be omitted and the remaining legend may be on three lines
5	Illumination requirements: Schedule 17, item 8

**Status:** This is the original version (as it was originally made). This item of legislation is currently only available in its original format.

SCHEDULE 3 SIGNS FOR RAILWAY AND TRAMWAY LEVEL CROSSINGS (contd.)



(50)  
62.5  
(75)  
(100)  
(125)

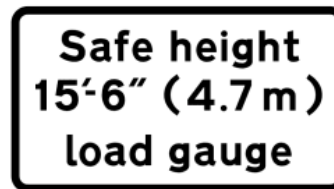

(50)  
62.5  
(75)  
(100)  
(125)

780.1A  
Safe height beneath electrified overhead cable  
in direction and at distance indicated

Item	
1	Regulations: 17(5)
2	Directions: 20(1), 21(1)
3	Diagrams: 779
4	Permitted variants: Schedule 16, items 1, 6, 9, 13, 14 The indication of height in metric units may be omitted
5	Illumination requirements: Schedule 17, item 8

780.2A  
Safe height beneath electrified overhead cable ahead  
provided with a load gauge shown in diagram 781

Item	
1	Regulations: 17(5)
2	Directions: 20(1), 21(1)
3	Diagrams: 779
4	Permitted variants: Schedule 16, item 1 Same as diagram 780.1A
5	Illumination requirements: Schedule 17, item 8

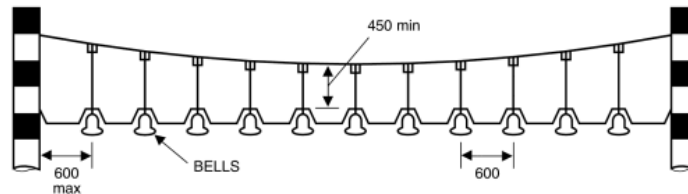

781  
Load gauge giving audible warning to drivers  
where vehicle exceeds safe height under  
electrified overhead cables

Item	
1	Regulations: None
2	Directions: 43
3	Diagrams: None
4	Permitted variants: Schedule 16, item 41
5	Illumination requirements: None

*Status: This is the original version (as it was originally made). This item of legislation is currently only available in its original format.*

SCHEDULE 3 SIGNS FOR RAILWAY AND TRAMWAY LEVEL CROSSINGS (contd.)



600  
(750)  
(900)  
(1200)  
(1500)

782

Risk of grounding at a railway or tramway level crossing or hump backed bridge

Item	
1	Regulations: None
2	Directions: 21(1)
3	Diagrams: 528, 572, 573, 783, 785.1, 786
4	Permitted variants: None
5	Illumination requirements: Schedule 17, item 1

50 min  
100 max



783

Drivers of long low vehicles must telephone to obtain permission before using a railway or tramway level crossing

Item	
1	Regulations: None
2	Directions: 20(1)
3	Diagrams: 601.1, 782, 785.1, 786, 787, 788
4	Permitted variants: "LONG LOW" may be varied to "LARGE OR SLOW"
5	Illumination requirements: Schedule 17, item 4



45 min  
75 max

30 min  
50 max

784.1

Drivers of large or slow vehicles must stop and telephone before using an automatic railway or tramway level crossing

Item	
1	Regulations: 10(1), 10(2), 16
2	Directions: None
3	Diagrams: 786, 787, 788
4	Permitted variants: None
5	Illumination requirements: Schedule 17, item 1

**Status:** This is the original version (as it was originally made). This item of legislation is currently only available in its original format.

SCHEDULE 3 SIGNS FOR RAILWAY AND TRAMWAY LEVEL CROSSINGS (contd.)



785.1  
Name of level crossing and details of telephone number for contacting railway or tramway operator

Item	
1	Regulations: None
2	Directions: None
3	Diagrams: 782, 783
4	Permitted variants: Schedule 16, item 19 The number of lines of legend in the top panel may be varied. "TO CONTACT RAILWAY" may be on one line. "RAILWAY" may be varied to "TRAM Co." The telephone number shall be varied as appropriate
5	Illumination requirements: Schedule 17, item 4



787  
Site of emergency telephone or telephone at or near a railway or tramway level crossing

Item	
1	Regulations: None
2	Directions: None
3	Diagrams: 783, 784.1, 786, 788
4	Permitted variants: None
5	Illumination requirements: Schedule 17, item 4



786  
Place where large or slow, or long low vehicles should wait near a railway or tramway level crossing while the driver obtains permission by telephone to cross or confirms he has crossed

Item	
1	Regulations: None
2	Directions: 25(1)
3	Diagrams: 782, 783, 784.1, 787, 788, 1028.3
4	Permitted variants: "AT CROSSING" may be omitted
5	Illumination requirements: Schedule 17, item 4

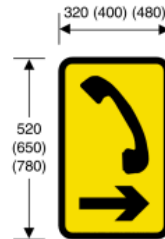

788  
Direction to emergency telephone or telephone at or near a railway or tramway level crossing

Item	
1	Regulations: None
2	Directions: None
3	Diagrams: 783, 784.1, 786, 787
4	Permitted variants: Schedule 16, item 13
5	Illumination requirements: Schedule 17, item 4

**Status:** This is the original version (as it was originally made). This item of legislation is currently only available in its original format.

SCHEDULE 3 SIGNS FOR RAILWAY AND TRAMWAY LEVEL CROSSINGS (contd.)

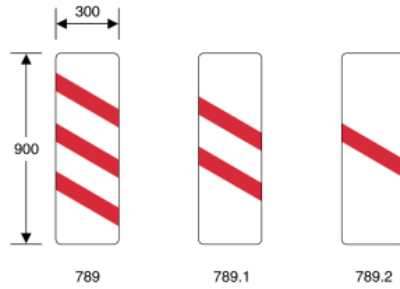

789, 789.1, 789.2  
Countdown markers to railway or tramway level crossing

Item	
1	Regulations: None
2	Directions: None
3	Diagrams: None
4	Permitted variants: Schedule 16, item 28
5	Illumination requirements: Schedule 17, item 4



790  
New method of controlling traffic at a railway or tramway level crossing ahead

Item	
1	Regulations: None
2	Directions: 37(1)
3	Diagrams: None
4	Permitted variants: "CONTROL" may be omitted
5	Illumination requirements: Schedule 17, item 1



**Status:** This is the original version (as it was originally made). This item of legislation is currently only available in its original format.

## SCHEDULE 4

### MISCELLANEOUS INFORMATORY SIGNS

#### SCHEDULE 4

Regulation 11(1)

#### MISCELLANEOUS INFORMATORY SIGNS

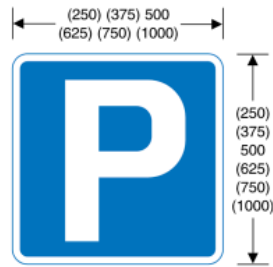

801  
Parking place

Item	
1	Regulations: None
2	Directions: 21(1), 25
3	Diagrams: 804.1, 804.2, 804.3, 804.4, 1028.3 (when diagram 801 is used with 804.1), 1028.4, 1032, 1033
4	Permitted variants: None
5	Illumination requirements: Schedule 17, item 4

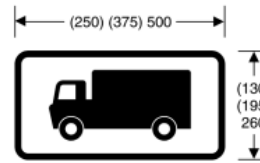

804.1  
Parking place for goods vehicles

Item	
1	Regulations: None
2	Directions: 7, 21(1), 25
3	Diagrams: 801
4	Permitted variants: None
5	Illumination requirements: Schedule 17, item 8



804.2  
Parking place for motor cars

Item	
1	Regulations: None
2	Directions: 7, 21(1)
3	Diagrams: 801
4	Permitted variants: None
5	Illumination requirements: Schedule 17, item 8

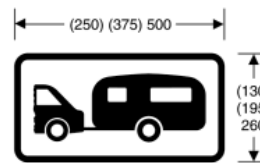

804.3  
Parking place for motorised caravans  
or caravans drawn by motor vehicles

Item	
1	Regulations: None
2	Directions: 7, 21(1)
3	Diagrams: 801
4	Permitted variants: None
5	Illumination requirements: Schedule 17, item 8

**Status:** This is the original version (as it was originally made). This item of legislation is currently only available in its original format.

SCHEDULE 4 MISCELLANEOUS INFORMATORY SIGNS (contd.)

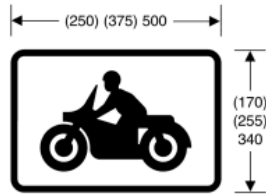

804.4  
Parking place for solo motor cycles

Item	
1	Regulations: None
2	Directions: 7, 21(1)
3	Diagrams: 801
4	Permitted variants: None
5	Illumination requirements: Schedule 17, item 8



810  
One-way traffic in direction indicated  
(Sign for pedestrians)

Item	
1	Regulations: 27(1)
2	Directions: 7
3	Diagrams: None
4	Permitted variants: Schedule 16, item 13
5	Illumination requirements: Schedule 17, item 9

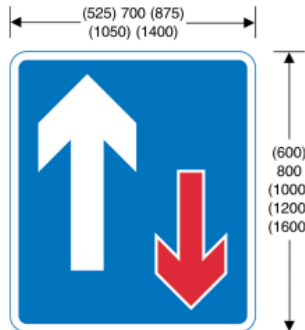

811  
Traffic has priority over vehicles  
from the opposite direction

Item	
1	Regulations: None
2	Directions: 19, 20(1), 21(1)
3	Diagrams: 615, 645, 811.1, 1043, 1044
4	Permitted variants: None
5	Illumination requirements: Schedule 17, item 4

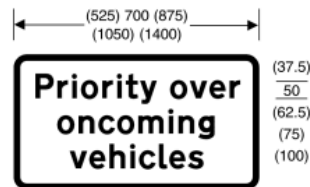

811.1  
Explanatory plate for the sign  
shown in diagram 811

Item	
1	Regulations: None
2	Directions: 20(1), 21(1)
3	Diagrams: 811
4	Permitted variants: Schedule 16, item 6 "for" and a distance may be added
5	Illumination requirements: Schedule 17, item 8

**Status:** This is the original version (as it was originally made). This item of legislation is currently only available in its original format.

SCHEDULE 4 MISCELLANEOUS INFORMATORY SIGNS (contd.)

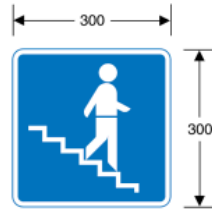

814.1  
Stepped entrance to pedestrian subway

Item	
1	Regulations: None
2	Directions: None
3	Diagrams: None
4	Permitted variants: The sign may be reversed in a mirror image
5	Illumination requirements: Schedule 17, item 9

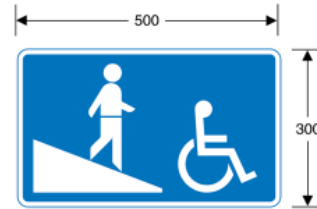

814.2  
Ramped entrance to pedestrian subway

Item	
1	Regulations: None
2	Directions: None
3	Diagrams: None
4	Permitted variants: Same as diagram 814.1. The wheelchair symbol shall be omitted and the width of the sign reduced to 300mm where the subway is not suitable for use by disabled people
5	Illumination requirements: Schedule 17, item 9

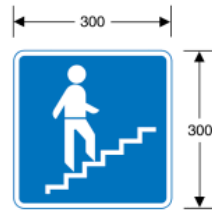

814.3  
Stepped approach to pedestrian overbridge

Item	
1	Regulations: None
2	Directions: None
3	Diagrams: None
4	Permitted variants: The sign may be reversed in a mirror image
5	Illumination requirements: Schedule 17, item 9

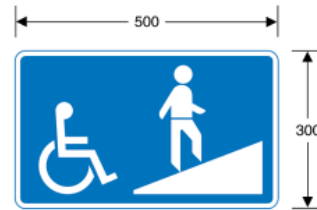

814.4  
Ramped approach to pedestrian overbridge

Item	
1	Regulations: None
2	Directions: None
3	Diagrams: None
4	Permitted variants: Same as diagram 814.3. The wheelchair symbol shall be omitted and the width of the sign reduced to 300mm where the overbridge is not suitable for use by disabled people
5	Illumination requirements: Schedule 17, item 9

**Status:** This is the original version (as it was originally made). This item of legislation is currently only available in its original format.

SCHEDULE 4 MISCELLANEOUS INFORMATORY SIGNS (contd.)

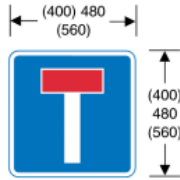

816  
No through road for vehicular traffic

Item	
1	Regulations: None
2	Directions: 21(1)
3	Diagrams: 954.4
4	Permitted variants: None
5	Illumination requirements: Schedule 17, item 4

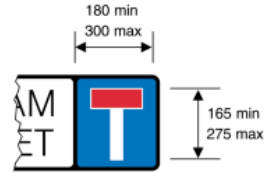

816.1  
Alternative to the sign shown in diagram 816 with a street nameplate

Item	
1	Regulations: None
2	Directions: None
3	Diagrams: None
4	Permitted variants: The blue panel need not extend to the edge of the name plate. The black border may be omitted
5	Illumination requirements: Schedule 17, item 9

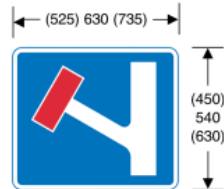

817  
No through road for vehicular traffic in direction indicated from junction ahead

Item	
1	Regulations: None
2	Directions: None
3	Diagrams: None
4	Permitted variants: Schedule 16, item 16
5	Illumination requirements: Schedule 17, item 4



817.2  
Escape lane ahead for vehicles unable to stop on steep hill

Item	
1	Regulations: None
2	Directions: 21(1)
3	Diagrams: 523.1, 554.1
4	Permitted variants: Schedule 16, items 6, 16 "ahead" may be varied to a distance or to an arrow pointing to the left, or omitted
5	Illumination requirements: Schedule 17, item 8

**Status:** This is the original version (as it was originally made). This item of legislation is currently only available in its original format.

SCHEDULE 4 MISCELLANEOUS INFORMATORY SIGNS (contd.)



(75)  
100  
(125)  
(150)  
(200)

818  
Section of dual carriageway road begins directly ahead

Item	
1	Regulations: None
2	Directions: None
3	Diagrams: None
4	Permitted variants: None
5	Illumination requirements: Schedule 17, item 4



(75)  
100  
(125)  
(150)  
(200)

818.1  
Distance to a section of dual carriageway road ahead

Item	
1	Regulations: None
2	Directions: None
3	Diagrams: None
4	Permitted variants: Schedule 16, item 6, but the distance shall not exceed 2 miles
5	Illumination requirements: Schedule 17, item 4



(75)  
100  
(125)  
(150)  
(200)

818.1A  
Distance over which a short length of dual carriageway road beginning directly ahead extends

Item	
1	Regulations: None
2	Directions: None
3	Diagrams: None
4	Permitted variants: "1/2 mile" may be varied to "1/4 mile"
5	Illumination requirements: Schedule 17, item 4



— 60 min  
— 200 max

818.2  
Nature of and distance to a prohibition, restriction or requirement ahead

Item	
1	Regulations: None
2	Directions: 7
3	Diagrams: None
4	Permitted variants: Schedule 16, items 6, 10, 11 "ahead" must be omitted when an arrow is included under item 10 or 11 of Schedule 16. The legend shall be varied to accord with the prohibition, restriction or requirement
5	Illumination requirements: Schedule 17, item 4

**Status:** This is the original version (as it was originally made). This item of legislation is currently only available in its original format.

SCHEDULE 4 MISCELLANEOUS INFORMATORY SIGNS (contd.)

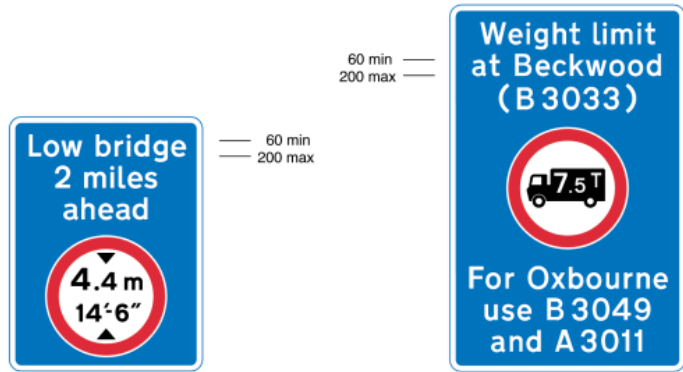

818.3  
Same as diagram 818.2

818.4  
Nature and location of a prohibition, restriction or requirement with indication of alternative route

Item	
1	Regulations: None
2	Directions: 7
3	Diagrams: None
4	<p>Permitted variants: Schedule 16, items 1, 6, 10, 11 "ahead" must be omitted when an arrow is included under item 10 or 11 of Schedule 16. "Low bridge" may be varied to "Height limit", "Weight limit", "Weak road", "Weak bridge", "Width limit", "Length limit" or omitted. The distance shall be shown below the diagram 629.2A symbol when "Low bridge" is omitted. The diagram 629.2A symbol may be varied to diagrams 622.1A (with the symbol reversed as appropriate), 626.2A (prohibitory roundel only), 629, 629A, 629.1 (with the symbol reversed as appropriate) or 629.2 as appropriate to accord with the prohibition. An indication of an alternative route may be added below the roundel in the manner shown in diagram 818.4</p>
5	Illumination requirements: Schedule 17, item 4

Item	
1	Regulations: None
2	Directions: 7
3	Diagrams: None
4	<p>Permitted variants: Schedule 16, items 11, 19, 20, 28 Same as diagram 622.1A. "Weight limit" may be varied to "Weak road", "Weak bridge", "Width limit", "Length limit", "Height limit" or omitted. The legend "at Beckwood (B 3033)" may be varied to an appropriate description. The diagram 622.1A symbol may be varied to diagrams 626.2A (prohibitory roundel only), 629, 629A, 629.1 (with the symbol reversed as appropriate), 629.2 or 629.2A as appropriate to accord with the prohibition. The legend below the 622.1A symbol may be varied to "Alternative route follow" and either a symbol shown in Part VII of Schedule 13 or a description of the route. The legend "For Oxbourne" may be varied to "Alternative route". When the sign is placed on a motorway, "use" and the route numbers may be varied to "leave at Junction" and the junction number, or "at Junction" and the junction number may be added after "use" and a route number; "Junction" may be varied to "J"</p>
5	Illumination requirements: Schedule 17, item 4

**Status:** This is the original version (as it was originally made). This item of legislation is currently only available in its original format.

SCHEDULE 4 MISCELLANEOUS INFORMATORY SIGNS (contd.)



820  
Road unsuitable for type of vehicle indicated

Item	
1	Regulations: 22
2	Directions: None
3	Diagrams: None
4	Permitted variants: Schedule 16, item 11 "motor vehicles" may be varied to: 1. "caravans" 2. "heavy goods vehicles" or "HGVs" 3. "wide vehicles" 4. "long vehicles" 5. "articulated vehicles" 6. "trailers" 7. "buses"
5	Illumination requirements: Schedule 17, item 4



820.1  
Absence of hard shoulder for the distance shown

Item	
1	Regulations: None
2	Directions: None
3	Diagrams: None
4	Permitted variants: Schedule 16, item 6 "for 400 yards" may be varied to "400 yards ahead". The legend may be on four lines
5	Illumination requirements: Schedule 17, item 4



821  
Road ahead only wide enough for one line of vehicles, but has passing places at intervals

Item	
1	Regulations: None
2	Directions: None
3	Diagrams: 822
4	Permitted variants: Schedule 16, item 6 "with passing places" may be varied to "Use passing places to permit overtaking" or to "No passing places for" and a distance expressed in yards or miles as appropriate
5	Illumination requirements: Schedule 17, item 4

**Status:** This is the original version (as it was originally made). This item of legislation is currently only available in its original format.

SCHEDULE 4 MISCELLANEOUS INFORMATORY SIGNS (contd.)

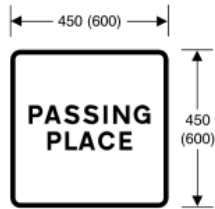

822  
Passing place on a narrow road

Item	
1	Regulations: None
2	Directions: None
3	Diagrams: 821
4	Permitted variants: None
5	Illumination requirements: Schedule 17, item 4

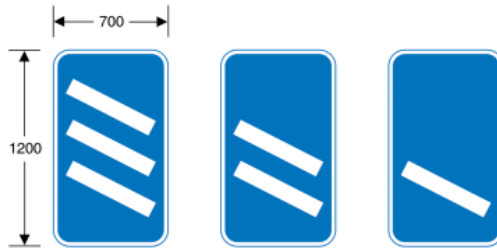

823                      824                      825

823, 824, 825  
Distance in hundreds of yards to a roundabout or the next point at which traffic may leave a route

Item	
1	Regulations: None
2	Directions: 15(1)
3	Diagrams: None
4	Permitted variants: Schedule 16, item 28 Background colour shall be varied to green on primary routes, and white with black symbols and border on non-primary routes
5	Illumination requirements: Schedule 17, item 4



**Status:** This is the original version (as it was originally made). This item of legislation is currently only available in its original format.

SCHEDULE 4 MISCELLANEOUS INFORMATORY SIGNS (contd.)

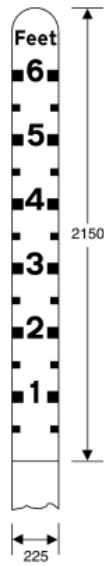

826  
Depth of water at a ford

Item	
1	Regulations: None
2	Directions: None
3	Diagrams: None
4	Permitted variants: None
5	Illumination requirements: Schedule 17, item 9

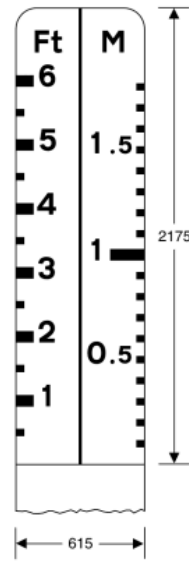

826.1  
As diagram 826, showing metric and imperial measurements

Item	
1	Regulations: None
2	Directions: None
3	Diagrams: None
4	Permitted variants: None
5	Illumination requirements: Schedule 17, item 9

**Status:** This is the original version (as it was originally made). This item of legislation is currently only available in its original format.

SCHEDULE 4 MISCELLANEOUS INFORMATORY SIGNS (contd.)



827.1  
Hospital ahead without  
accident and emergency facilities

Item	
1	Regulations: None
2	Directions: None
3	Diagrams: None
4	Permitted variants: None
5	Illumination requirements: Schedule 17, item 4



827.2  
Hospital ahead with  
accident and emergency facilities

Item	
1	Regulations: None
2	Directions: None
3	Diagrams: None
4	Permitted variants: The legend "not 24 hrs" may be omitted
5	Illumination requirements: Schedule 17, item 4

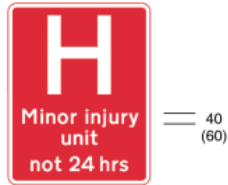

827.3  
Hospital ahead with facilities  
for treating minor injuries

Item	
1	Regulations: None
2	Directions: None
3	Diagrams: None
4	Permitted variants: Same as diagram 827.2
5	Illumination requirements: Schedule 17, item 4



829.1  
Potential danger temporarily ahead  
and consequent need to proceed with caution

Item	
1	Regulations: 14(1), 54
2	Directions: 39(4)
3	Diagrams: None
4	Permitted variants: None
5	Illumination requirements: Schedule 17, item 4

**Status:** This is the original version (as it was originally made). This item of legislation is currently only available in its original format.

SCHEDULE 4 MISCELLANEOUS INFORMATORY SIGNS (contd.)



829.2  
Accident ahead and consequent need to proceed with caution

Item	
1	Regulations: 14(1), 54
2	Directions: 39(4)
3	Diagrams: None
4	Permitted variants: None
5	Illumination requirements: Schedule 17, item 4



829.3  
Traffic should use the hard shoulder in an emergency

Item	
1	Regulations: 14(1), 54
2	Directions: 39(4)
3	Diagrams: 829.4
4	Permitted variants: None
5	Illumination requirements: Schedule 17, item 4

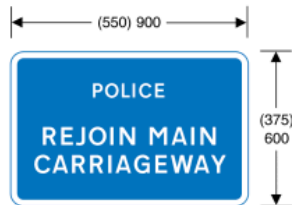

829.4  
End of temporary permission for traffic to use the hard shoulder

Item	
1	Regulations: 14(1), 54
2	Directions: 39(4)
3	Diagrams: 829.3
4	Permitted variants: None
5	Illumination requirements: Schedule 17, item 4



829.5  
Area where police carry out checks on the speed of vehicles

Item	
1	Regulations: None
2	Directions: 39(4), 39(5)
3	Diagrams: None
4	Permitted variants: None
5	Illumination requirements: Schedule 17, item 4

**Status:** This is the original version (as it was originally made). This item of legislation is currently only available in its original format.

SCHEDULE 4 MISCELLANEOUS INFORMATORY SIGNS (contd.)



829.6  
Waiting place at a lay-by or observation platform for police vehicles only

Item	
1	Regulations: None
2	Directions: None
3	Diagrams: None
4	Permitted variants: "patrol" may be omitted
5	Illumination requirements: Schedule 17, item 4

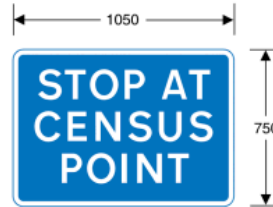

830  
Vehicles will be required to stop at a traffic survey

Item	
1	Regulations: None
2	Directions: 39(6)
3	Diagrams: None
4	Permitted variants: "CENSUS POINT" may be varied to "WEIGHT CHECK" or "CHECK POINT"
5	Illumination requirements: Schedule 17, item 4

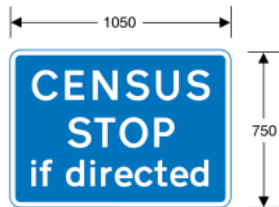

830.1  
Vehicles may be directed to stop at a traffic survey ahead

Item	
1	Regulations: None
2	Directions: 39(6)
3	Diagrams: None
4	Permitted variants: "CENSUS" may be varied to "CYCLISTS", "WEIGHT CHECK" or "VEHICLE CHECK"
5	Illumination requirements: Schedule 17, item 4



830.2  
Goods vehicles may be directed to stop ahead by a constable in uniform for the purposes of sections 67, 68 or 78 of the Road Traffic Act 1988

Item	
1	Regulations: None
2	Directions: None
3	Diagrams: None
4	Permitted variants: None
5	Illumination requirements: Schedule 17, item 4

**Status:** This is the original version (as it was originally made). This item of legislation is currently only available in its original format.

SCHEDULE 4 MISCELLANEOUS INFORMATORY SIGNS (contd.)

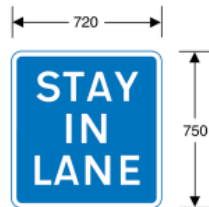

830.3  
Vehicles should stay in lane for the purposes of a traffic survey, or a weight or vehicle check ahead

Item	
1	Regulations: None
2	Directions: 39(6)
3	Diagrams: None
4	Permitted variants: "STAY" may be varied to "GET"
5	Illumination requirements: Schedule 17, item 4

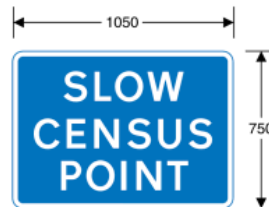

831  
Vehicles should reduce speed on approaching a traffic survey ahead

Item	
1	Regulations: None
2	Directions: 39(6)
3	Diagrams: None
4	Permitted variants: Same as diagram 830
5	Illumination requirements: Schedule 17, item 4



831.2  
Vehicle excise licence check point ahead

Item	
1	Regulations: None
2	Directions: None
3	Diagrams: None
4	Permitted variants: "EXCISE LICENCE" may be varied to "EMISSIONS"
5	Illumination requirements: Schedule 17, item 4

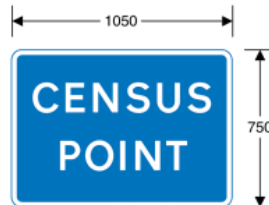

832  
Location of traffic survey

Item	
1	Regulations: None
2	Directions: 39(6)
3	Diagrams: None
4	Permitted variants: Same as diagram 830
5	Illumination requirements: Schedule 17, item 4

**Status:** This is the original version (as it was originally made). This item of legislation is currently only available in its original format.

SCHEDULE 4 MISCELLANEOUS INFORMATORY SIGNS (contd.)

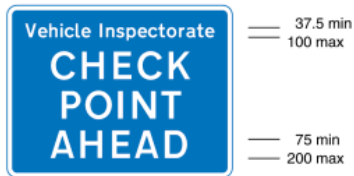

832.1A  
Vehicle check point ahead

Item	
1	Regulations: None
2	Directions: None
3	Diagrams: None
4	Permitted variants: "Vehicle Inspectorate" may be varied to "GOODS VEHICLE"
5	Illumination requirements: Schedule 17, item 4



832.2A  
Vehicle condition check point ahead

Item	
1	Regulations: None
2	Directions: None
3	Diagrams: None
4	Permitted variants: None
5	Illumination requirements: Schedule 17, item 4



832.3  
Goods vehicles may be directed to leave the motorway at a junction ahead

Item	
1	Regulations: 24
2	Directions: 14(1)
3	Diagrams: None
4	Permitted variants: The bus symbol shown in diagram 952 may be added below or substituted for the lorry symbol
5	Illumination requirements: Schedule 17, item 4



832.4  
Goods vehicles may be directed to enter a check point ahead

Item	
1	Regulations: 24
2	Directions: None
3	Diagrams: None
4	Permitted variants: The bus symbol shown in diagram 952 may be added below or substituted for the lorry symbol. "if directed" may be omitted
5	Illumination requirements: Schedule 17, item 4

**Status:** This is the original version (as it was originally made). This item of legislation is currently only available in its original format.

SCHEDULE 4 MISCELLANEOUS INFORMATORY SIGNS (contd.)



100 min  
250 max

832.5

Goods vehicles should keep to left hand lane on approach to check point ahead

Item	
1	Regulations: 24
2	Directions: None
3	Diagrams: None
4	Permitted variants: The bus symbol shown in diagram 952 may be added below or substituted for the lorry symbol
5	Illumination requirements: Schedule 17, item 4

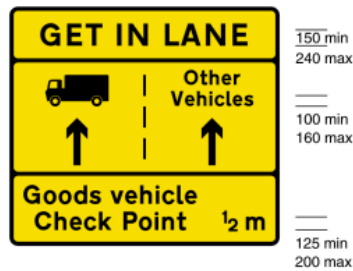

150 min  
240 max

100 min  
160 max

125 min  
200 max

832.6

Goods vehicles should get into the left hand lane and other vehicles should use the right hand lane of a two lane carriageway on the approach to a goods vehicle check point ahead

Item	
1	Regulations: 24
2	Directions: None
3	Diagrams: None
4	Permitted variants: Schedule 16, item 7 An additional lane may be indicated on the right hand side of the centre panel of the sign. "GET IN LANE" may be varied to "STAY IN LANE". The bus symbol shown in diagram 952 may be added below or substituted for the lorry symbol. "Goods vehicle" may be varied to "Goods vehicle and PSV" or "PSV", where "PSV" denotes a public service vehicle
5	Illumination requirements: Schedule 17, item 4

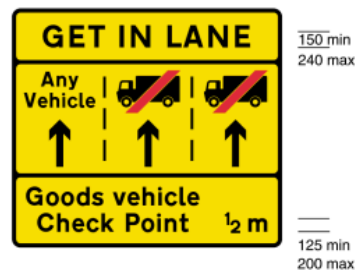

150 min  
240 max

100 min  
160 max

125 min  
200 max

832.7

Goods vehicles should get into the left hand lane of a three lane carriageway on the approach to a goods vehicle check point ahead

Item	
1	Regulations: 24
2	Directions: None
3	Diagrams: None
4	Permitted variants: Schedule 16, item 7 The right hand lane may be omitted. "GET IN LANE" may be varied to "STAY IN LANE". The bus symbol shown in diagram 952 with a red diagonal bar may be added below or substituted for the lorry symbol. "Goods vehicle" may be varied to "Goods vehicle and PSV" or "PSV", where "PSV" denotes a public service vehicle
5	Illumination requirements: Schedule 17, item 4

**Status:** This is the original version (as it was originally made). This item of legislation is currently only available in its original format.

SCHEDULE 4 MISCELLANEOUS INFORMATORY SIGNS (contd.)



832.8  
Goods vehicles should leave the main carriageway of a road on the approach to a goods vehicle check point

Item	
1	Regulations: None
2	Directions: None
3	Diagrams: None
4	Permitted variants: The legend may be varied to "All goods vehicles and PSVs" or " All PSVs", where "PSV" denotes a public service vehicle
5	Illumination requirements: Schedule 17, item 4



832.9  
Direction to a vehicle check point

Item	
1	Regulations: None
2	Directions: None
3	Diagrams: None
4	Permitted variants: Schedule 16, item 15
5	Illumination requirements: Schedule 17, item 4



832.10A  
End of vehicle check point area

Item	
1	Regulations: None
2	Directions: None
3	Diagrams: None
4	Permitted variants: None
5	Illumination requirements: Schedule 17, item 4



**Status:** This is the original version (as it was originally made). This item of legislation is currently only available in its original format.

SCHEDULE 4 MISCELLANEOUS INFORMATORY SIGNS (contd.)

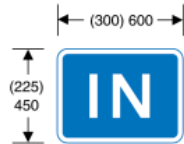

833  
Entrance to a car park,  
private access road or property

Item	
1	Regulations: None
2	Directions: 31
3	Diagrams: None
4	Permitted variants: None
5	Illumination requirements: Schedule 17, item 9

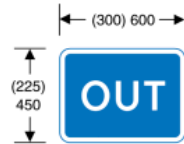

834  
Exit from a car park,  
private access road or property

Item	
1	Regulations: None
2	Directions: 31
3	Diagrams: None
4	Permitted variants: None
5	Illumination requirements: Schedule 17, item 9

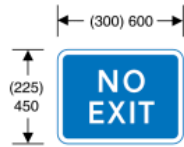

835  
Exit from a car park, private access road  
or property to a public road not allowed

Item	
1	Regulations: None
2	Directions: 31
3	Diagrams: None
4	Permitted variants: None
5	Illumination requirements: Schedule 17, item 9

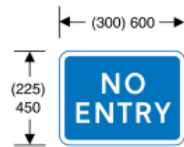

836  
Entry to a car park, private access road  
or property from a public road not allowed

Item	
1	Regulations: None
2	Directions: 31
3	Diagrams: None
4	Permitted variants: None
5	Illumination requirements: Schedule 17, item 9

**Status:** This is the original version (as it was originally made). This item of legislation is currently only available in its original format.

SCHEDULE 4 MISCELLANEOUS INFORMATORY SIGNS (contd.)

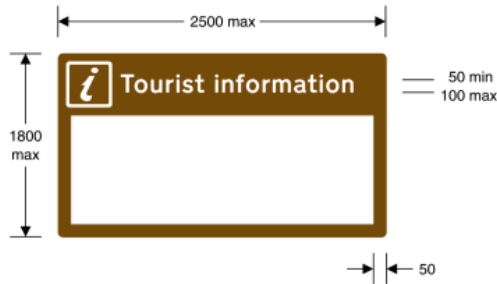

857

Information for pedestrians about tourist attractions and facilities in a nearby place or area

Item	
1	Regulations: None
2	Directions: None
3	Diagrams: None
4	Permitted variants: The white area is to be filled with maps and/or legend in any colour with lettering not exceeding 25 mm in height. The "i" symbol may be omitted. "Tourist information" may be varied to "Information". The logo of a local tourist organisation may be added at the top of the sign. The colour of the border and the background to the upper part of the sign shall be varied from brown to blue when the sign is not used as a Tourist Information Point. The sign may have more than one panel or side, each of the design prescribed in this diagram
5	Illumination requirements: Schedule 17, item 9

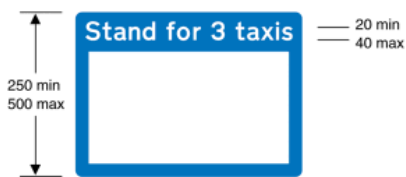

857.1

Information relating to a taxi rank for the number of taxis specified

Item	
1	Regulations: None
2	Directions: None
3	Diagrams: 639.1B, 650.1, 650.2, 650.3, 1028.2
4	Permitted variants: The number of taxis indicated may be varied as appropriate. Information relating to the taxi services from that rank may be shown in the white space in lettering of any colour with a letter height not exceeding 25 mm, or the white space may be omitted
5	Illumination requirements: Schedule 17, item 9

**Status:** This is the original version (as it was originally made). This item of legislation is currently only available in its original format.

SCHEDULE 4 MISCELLANEOUS INFORMATORY SIGNS (contd.)

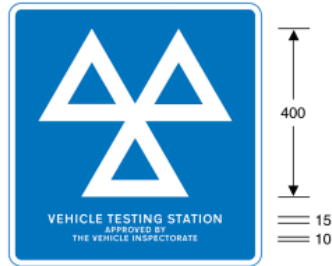

864.1  
Vehicle testing station approved by the Vehicle Inspectorate

Item	
1	Regulations: None
2	Directions: None
3	Diagrams: None
4	Permitted variants: None
5	Illumination requirements: Schedule 17, item 9



865  
Motor cycle test centre

Item	
1	Regulations: None
2	Directions: None
3	Diagrams: None
4	Permitted variants: None
5	Illumination requirements: Schedule 17, item 9

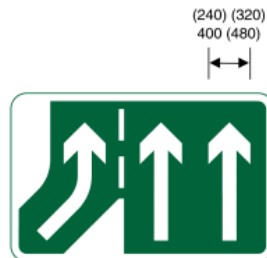

868  
Additional traffic lane joining from the left ahead

Item	
1	Regulations: None
2	Directions: 15(1), 21(1)
3	Diagrams: 876
4	Permitted variants: Schedule 16, item 16 Background colour to be varied to blue with white symbols and border on motorways and white with black symbols and border on non-primary routes
5	Illumination requirements: Schedule 17, item 4



868.1  
Additional traffic lanes joining from the right ahead

Item	
1	Regulations: None
2	Directions: 15(1), 21(1)
3	Diagrams: 876
4	Permitted variants: Schedule 16, item 16 Same as diagram 868
5	Illumination requirements: Schedule 17, item 4

**Status:** This is the original version (as it was originally made). This item of legislation is currently only available in its original format.

SCHEDULE 4 MISCELLANEOUS INFORMATORY SIGNS (contd.)

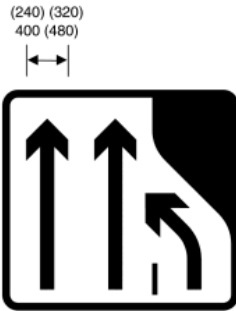

872.1

The number of traffic lanes ahead on a dual carriageway road or a one-way street reduces from three to two. Traffic in the right hand lane must move into the lane on the immediate left

Item	
1	Regulations: None
2	Directions: 15(1), 15(2), 21(1)
3	Diagrams: 876
4	Permitted variants: The sign may be reversed in a mirror image. The number of straight arrows may be varied. Background colour to be varied to blue with white symbols and border on motorways and green with white symbols and border on primary routes
5	Illumination requirements: Schedule 17, item 4

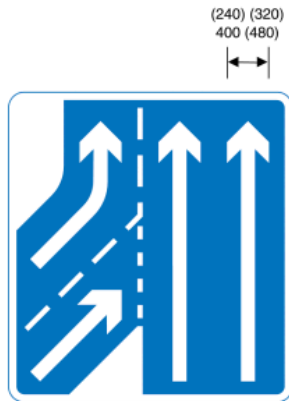

873

Additional traffic lane joining from the left ahead. Traffic on main carriageway has priority over joining traffic from the right hand lane of the slip road

Item	
1	Regulations: None
2	Directions: 15(1), 21(1)
3	Diagrams: 876
4	Permitted variants: Schedule 16, item 16 Background colour to be varied to green with white symbols and border on primary routes and white with black symbols and border on non-primary routes
5	Illumination requirements: Schedule 17, item 4

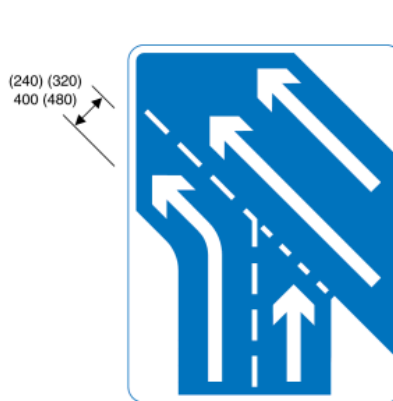

874

Additional traffic lanes joining from the right ahead. Traffic in the right hand lane joins the main carriageway. Traffic on the main carriageway has priority over joining traffic

Item	
1	Regulations: None
2	Directions: 15(1), 21(1)
3	Diagrams: 876
4	Permitted variants: Schedule 16, item 16 Same as diagram 873
5	Illumination requirements: Schedule 17, item 4

**Status:** This is the original version (as it was originally made). This item of legislation is currently only available in its original format.

SCHEDULE 4 MISCELLANEOUS INFORMATORY SIGNS (contd.)

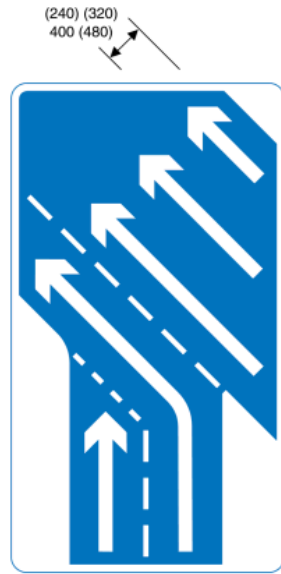

875  
Additional traffic lanes joining from the right ahead.  
Traffic in the right hand lane of the slip road has  
priority over traffic in the left hand lane

Item	
1	Regulations: None
2	Directions: 15(1), 21(1)
3	Diagrams: 876
4	Permitted variants: Schedule 16, item 16 Same as diagram 873
5	Illumination requirements: Schedule 17, item 4



876  
Distance to the change in the number of lanes  
indicated by the signs shown in diagrams 868 to 875

Item	
1	Regulations: None
2	Directions: 15(1), 21(1)
3	Diagrams: 868, 868.1, 872.1, 873, 874, 875
4	Permitted variants: Schedule 16, item 6 Same as diagram 873
5	Illumination requirements: Schedule 17, item 4

**Status:** This is the original version (as it was originally made). This item of legislation is currently only available in its original format.

SCHEDULE 4 MISCELLANEOUS INFORMATORY SIGNS (contd.)

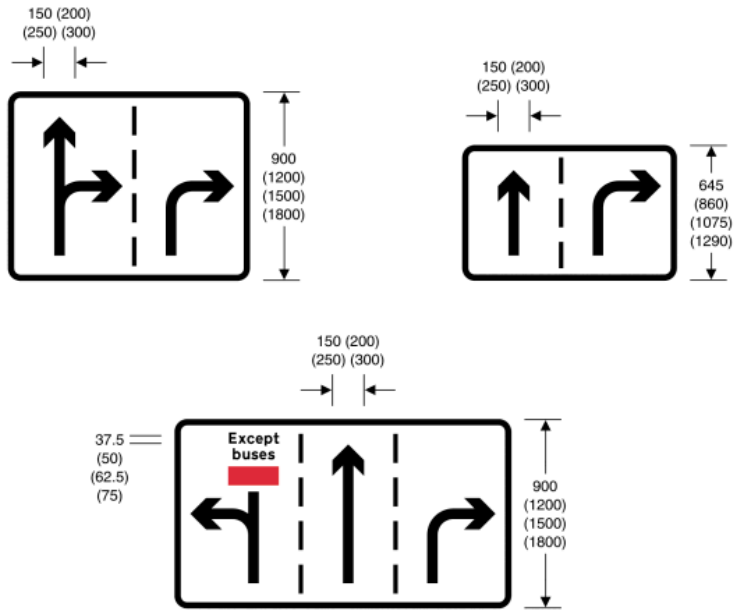

877  
Appropriate traffic lanes for different manoeuvres at a junction ahead  
(Alternative types)

Item	
1	Regulations: 22, 23
2	Directions: 15(3)
3	Diagrams: None
4	Permitted variants: Schedule 16, item 16 The words "Except buses" may be varied to "Bus lane" or omitted. The signs shown in the upper diagrams may be reversed in a mirror image. Any arrow may indicate two directions and point either horizontally to the left and ahead, horizontally to the right and ahead, or horizontally to the left and to the right. The background colour shall be varied to green with white symbols, legend and border on primary routes and blue with white symbols, legend and border on motorway exit slip roads. The red bar shall have a white edge when on a green or blue background. The chevron marking shown in diagram 2115.1, or in diagram 2018 when the background colour of the sign is varied to green or blue, may be added and varied as appropriate
5	Illumination requirements: Schedule 17, item 4

**Status:** This is the original version (as it was originally made). This item of legislation is currently only available in its original format.

SCHEDULE 4 MISCELLANEOUS INFORMATORY SIGNS (contd.)



878  
Area in which cameras are used to enforce traffic light signal regulations (Alternative types)

Item	
1	Regulations: 23
2	Directions: 32(1)
3	Diagrams: 879
4	Permitted variants: "Traffic signal" may be varied to "Speed", "Traffic signal and speed", "Traffic enforcement", "Police", "Police enforcement" or "Bus lane"
5	Illumination requirements: Schedule 17, item 4

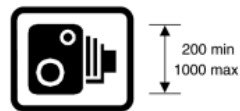

879  
Reminder to drivers within an area in which cameras are used to enforce traffic regulations

Item	
1	Regulations: None
2	Directions: 32(1)
3	Diagrams: 878
4	Permitted variants: None
5	Illumination requirements: Schedule 17, item 4

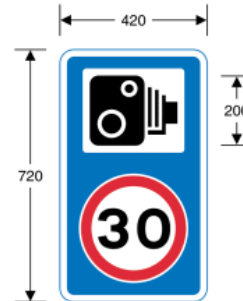

880  
Speed camera ahead and reminder of 30 mph speed limit

Item	
1	Regulations: None
2	Directions: 32(2)
3	Diagrams: None
4	Permitted variants: None
5	Illumination requirements: Schedule 17, item 4

**Status:** This is the original version (as it was originally made). This item of legislation is currently only available in its original format.

SCHEDULE 4 MISCELLANEOUS INFORMATORY SIGNS (contd.)

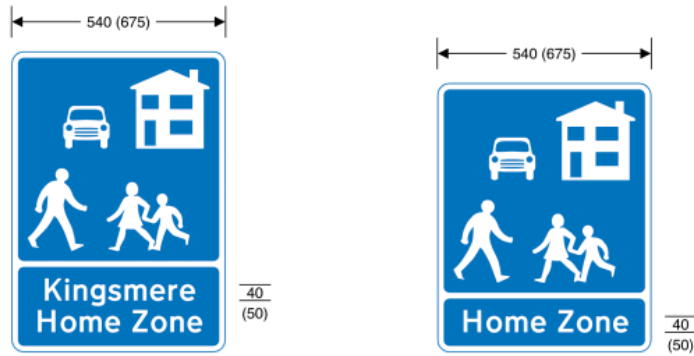

881  
Start of a home zone designated under section 268 of the Transport Act 2000 or section 74(1) of the Transport (Scotland) Act 2001 (Alternative types)

Item	
1	Regulations: None
2	Directions: None
3	Diagrams: None
4	Permitted variants: Schedule 16, item 19 The place name may be on more than one line
5	Illumination requirements: Schedule 17, item 4



882  
End of designated home zone

Item	
1	Regulations: None
2	Directions: None
3	Diagrams: None
4	Permitted variants: None
5	Illumination requirements: Schedule 17, item 4



**Status:** This is the original version (as it was originally made). This item of legislation is currently only available in its original format.

SCHEDULE 4 MISCELLANEOUS INFORMATORY SIGNS (contd.)



883

Start of area with traffic calming features  
of the type defined in regulation 4

Item	
1	Regulations: None
2	Directions: None
3	Diagrams: None
4	Permitted variants: Schedule 16, items 3, 6,11 The name of a place or street may be added
5	Illumination requirements: Schedule 17, item 4

**Status:** This is the original version (as it was originally made). This item of legislation is currently only available in its original format.

SCHEDULE 5

SIGNS FOR BUS, TRAM AND PEDAL CYCLE FACILITIES

SCHEDULE 5

Regulation 11(1)

SIGNS FOR BUS, TRAM AND PEDAL CYCLE FACILITIES

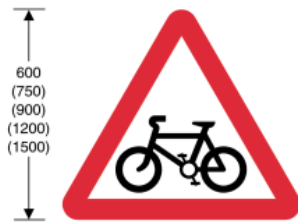

950  
Cycle route ahead

Item	
1	Regulations: None
2	Directions: 21(1), 39(7)
3	Diagrams: 572, 573, 950.1
4	Permitted variants: Schedule 16, item 28
5	Illumination requirements: Schedule 17, item 1



950.1  
Training or testing of child cyclists ahead

Item	
1	Regulations: None
2	Directions: 21(1), 39(7)
3	Diagrams: 950
4	Permitted variants: Schedule 16, items 3, 6, 11 "tests" may be varied to "training". "Child cycle tests" may be varied to "Cycles crossing" or "Cycle event"
5	Illumination requirements: Schedule 17, item 8

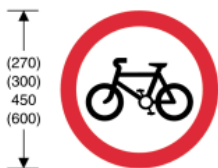

951  
Riding of pedal cycles prohibited

Item	
1	Regulations: None
2	Directions: 7, 8
3	Diagrams: None
4	Permitted variants: None
5	Illumination requirements: Schedule 17, items 4, 7

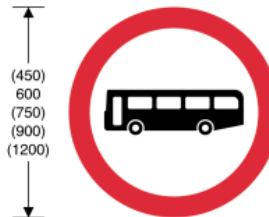

952  
Buses prohibited

Item	
1	Regulations: 24
2	Directions: 7, 8, 21(1)
3	Diagrams: 620, 954.2
4	Permitted variants: None
5	Illumination requirements: Schedule 17, item 1

**Status:** This is the original version (as it was originally made). This item of legislation is currently only available in its original format.

SCHEDULE 5 SIGNS FOR BUS, TRAM AND PEDAL CYCLE FACILITIES (contd.)

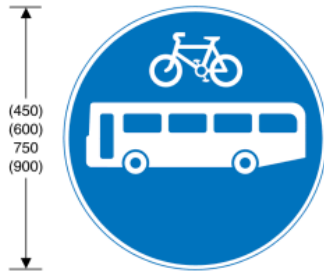

953  
Route for use by buses and pedal cycles only

Item	
1	Regulations: 10(1), 24
2	Directions: 7, 8, 18(1), 18(4), 20(1), 21(1)
3	Diagrams: 953.2, 1048.3, 1048.4
4	Permitted variants: The bus symbol may be varied to the local bus symbol shown in diagram 958. The cycle symbol may be omitted. The word "taxi" in white letters may be added below the bus symbol
5	Illumination requirements: Schedule 17, item 1

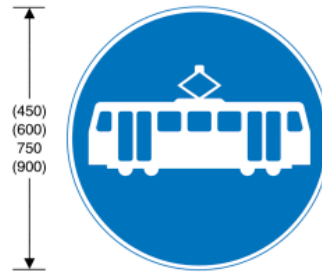

953.1  
Route for use by trams only

Item	
1	Regulations: 10(1), 24
2	Directions: 7, 8, 18(1), 20(1), 21(1)
3	Diagrams: 953.2, 1048.2
4	Permitted variants: The bus symbol shown in diagram 953 or the local bus symbol shown in diagram 958 may be added below the tramcar symbol
5	Illumination requirements: Schedule 17, item 1



953.2  
Explanatory plate for the signs shown in diagrams 953 and 953.1

Item	
1	Regulations: None
2	Directions: 7, 20(1), 21(1)
3	Diagrams: 953, 953.1
4	Permitted variants: None
5	Illumination requirements: Schedule 17, item 8



953.3  
Entrance to bus station, depot or garage

Item	
1	Regulations: 22
2	Directions: None
3	Diagrams: None
4	Permitted variants: None
5	Illumination requirements: Schedule 17, item 9

**Status:** This is the original version (as it was originally made). This item of legislation is currently only available in its original format.

SCHEDULE 5 SIGNS FOR BUS, TRAM AND PEDAL CYCLE FACILITIES (contd.)



(37.5)  
50  
(62.5)  
(75)  
(100)

954

Buses excluded from restriction or prohibition conveyed by associated sign

Item	
1	Regulations: 22
2	Directions: 7, 18(4), 21(1)
3	Diagrams: 606, 609, 612, 613, 616, 629, 629A, 629.1
4	Permitted variants: None
5	Illumination requirements: Schedule 17, item 8



(37.5)  
50  
(62.5)  
(75)  
(100)

954.2

Same as diagram 954 applying to local buses

Item	
1	Regulations: 22
2	Directions: 7, 18(4), 21(1)
3	Diagrams: 606, 609, 612, 613, 616, 629, 629A, 629.1, 952
4	Permitted variants: The legend may be on three lines
5	Illumination requirements: Schedule 17, item 8

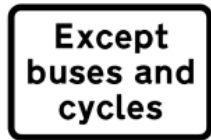

(37.5)  
50  
(62.5)  
(75)  
(100)

954.3

Same as diagram 954 applying to buses and pedal cycles

Item	
1	Regulations: 22
2	Directions: 7, 21(1), 21(2)
3	Diagrams: 606, 609, 612, 613
4	Permitted variants: The word "local" may be added before "buses". "buses and cycles" may be varied to "buses, taxis and cycles", "buses, taxis & cycles" or "buses and taxis"
5	Illumination requirements: Schedule 17, item 8

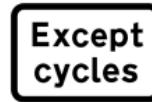

(37.5)  
50  
(62.5)  
(75)  
(100)

954.4

Same as diagram 954 applying to pedal cycles

Item	
1	Regulations: None
2	Directions: 7, 21(1), 21(2)
3	Diagrams: 606, 609, 612, 613, 816
4	Permitted variants: None
5	Illumination requirements: Schedule 17, item 8

**Status:** This is the original version (as it was originally made). This item of legislation is currently only available in its original format.

SCHEDULE 5 SIGNS FOR BUS, TRAM AND PEDAL CYCLE FACILITIES (contd.)



954.5  
Same as diagram 954 where the signs are mounted in combination with light signals prescribed by regulation 33

Item	
1	Regulations: 22
2	Directions: 7, 21(1)
3	Diagrams: 606, 612, 613
4	Permitted variants: "buses" may be varied to "cycles"
5	Illumination requirements: Schedule 17, item 6



954.6  
Same as diagram 954 applying to buses and pedal cycles where the signs are mounted in combination with light signals prescribed by regulation 33

Item	
1	Regulations: 22
2	Directions: 7, 21(1), 21(2)
3	Diagrams: 606, 612, 613
4	Permitted variants: "buses & cycles" may be varied to "local buses" or "buses & taxis"
5	Illumination requirements: Schedule 17, item 6



954.7  
Same as diagram 954 applying to buses, taxis and pedal cycles where the signs are mounted in combination with light signals prescribed by regulation 33

Item	
1	Regulations: 22
2	Directions: 7, 21(1), 21(2)
3	Diagrams: 606, 612, 613
4	Permitted variants: "buses, taxis & cycles" may be varied to "local buses & cycles" or "local buses & taxis"
5	Illumination requirements: Schedule 17, item 6

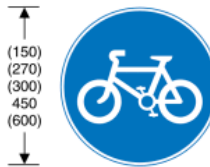

955  
Route for use by pedal cycles only

Item	
1	Regulations: None
2	Directions: 7, 8, 18(1), 18(5), 21(1)
3	Diagrams: 1003, 1023, 1049, 1057, 2602.3
4	Permitted variants: None
5	Illumination requirements: Schedule 17, items 3, 7

**Status:** This is the original version (as it was originally made). This item of legislation is currently only available in its original format.

SCHEDULE 5 SIGNS FOR BUS, TRAM AND PEDAL CYCLE FACILITIES (contd.)

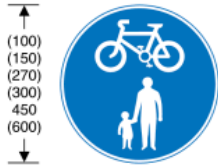

956  
Route for use by pedal cycles and pedestrians only

Item	
1	Regulations: None
2	Directions: 7, 8, 11, 18(1), 18(5), 21(1)
3	Diagrams: 1003, 1023, 1049, 1057, 2602.3
4	Permitted variants: None
5	Illumination requirements: Schedule 17, items 3, 7

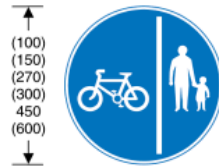

957  
Route comprising two ways, separated by the marking shown in diagram 1049 or 1049.1 or by physical means, for use by pedal cycles only and by pedestrians only

Item	
1	Regulations: None
2	Directions: 7, 8, 11, 17, 18(1), 18(3), 18(5), 21(1), 33
3	Diagrams: 1003, 1023, 1049, 1049.1, 1057, 2602.3
4	Permitted variants: Symbols may be reversed in a mirror image
5	Illumination requirements: Schedule 17, items 3, 7

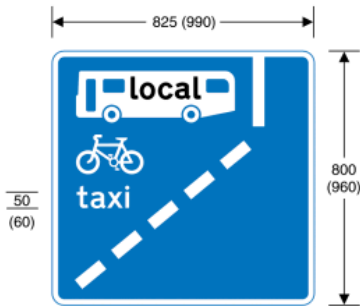

958  
With-flow bus lane which pedal cycles and taxis may also use ahead

Item	
1	Regulations: 23, 24
2	Directions: 7, 17, 21(1)
3	Diagrams: 961, 1010
4	Permitted variants: The word "taxi" may be omitted. The local bus symbol may be varied to the bus symbol shown in diagram 960
5	Illumination requirements: Schedule 17, item 4

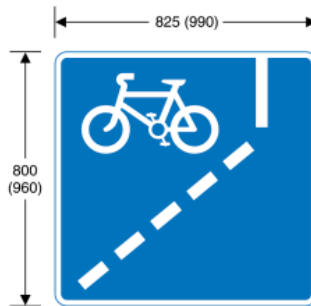

958.1  
With-flow cycle lane ahead

Item	
1	Regulations: None
2	Directions: 7, 17, 21(1)
3	Diagrams: 961, 1009
4	Permitted variants: None
5	Illumination requirements: Schedule 17, item 4

**Status:** This is the original version (as it was originally made). This item of legislation is currently only available in its original format.

SCHEDULE 5 SIGNS FOR BUS, TRAM AND PEDAL CYCLE FACILITIES (contd.)

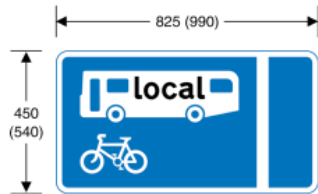

959

With-flow bus lane which pedal cycles may also use  
 Note: Any vehicle may enter the bus lane to stop, load or unload where this is not prohibited

Item	
1	Regulations: 23, 24
2	Directions: 7, 11, 17, 18(3), 21(1)
3	Diagrams: 961, 1048, 1049
4	Permitted variants: The local bus symbol may be varied to the bus symbol shown in diagram 960. The word "taxi" in white letters may be added alongside the cycle symbol
5	Illumination requirements: Schedule 17, item 4

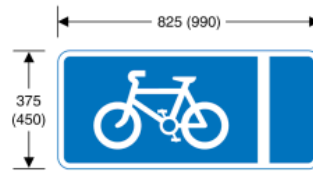

959.1

With-flow cycle lane

Item	
1	Regulations: None
2	Directions: 7, 11, 17, 18(1), 18(3), 18(5), 21(1)
3	Diagrams: 961, 1049, 1057
4	Permitted variants: None
5	Illumination requirements: Schedule 17, item 4

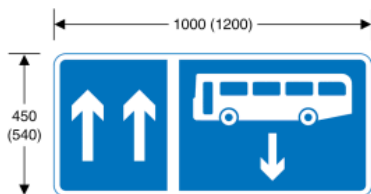

960

Contra-flow bus lane

Note: Any vehicle may enter the bus lane to stop, load or unload where this is not prohibited

Item	
1	Regulations: 23, 24
2	Directions: 7, 11, 17, 18(3)
3	Diagrams: 1048, 1048.1, 1049
4	Permitted variants: Schedule 16, item 16 The cycle symbol shown in diagram 959 may be added below the bus symbol and the downward pointing arrow moved towards the right. The bus symbol may be varied to the local bus symbol shown in diagram 959
5	Illumination requirements: Schedule 17, item 4

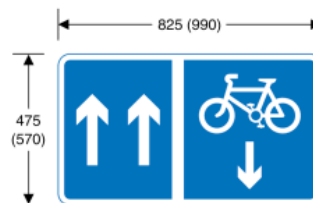

960.1

Contra-flow cycle lane

Item	
1	Regulations: None
2	Directions: 7, 11, 17, 18(1), 18(3), 18(5)
3	Diagrams: 1003, 1023, 1049, 1057
4	Permitted variants: Schedule 16, item 16
5	Illumination requirements: Schedule 17, item 4

**Status:** This is the original version (as it was originally made). This item of legislation is currently only available in its original format.

SCHEDULE 5 SIGNS FOR BUS, TRAM AND PEDAL CYCLE FACILITIES (contd.)

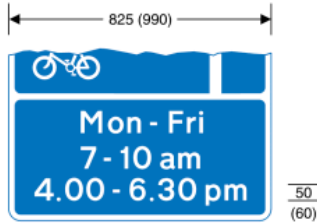

961  
Times of operation of a bus lane or cycle lane

Item	
1	Regulations: None
2	Directions: 7, 11, 21(1)
3	Diagrams: 958, 958.1, 959, 959.1
4	Permitted variants: Schedule 16, item 38
5	Illumination requirements: Schedule 17, item 4



962  
Bus lane on road at junction ahead

Item	
1	Regulations: 23, 24
2	Directions: 7
3	Diagrams: None
4	Permitted variants: Schedule 16, items 13, 14, 28, 38 Where the arrow is omitted the word "lane" shall be varied to "lanes". When the arrow is reversed the symbol must be reversed
5	Illumination requirements: Schedule 17, item 4



962.1  
Cycle lane on road at junction ahead or cycle track crossing road

Item	
1	Regulations: None
2	Directions: None
3	Diagrams: None
4	Permitted variants: Schedule 16, items 13, 14, 28, 38 "lane" may be varied to "track". Where the arrow is omitted "lane" shall be varied to "lanes", "track" or "tracks". When the arrow is reversed the symbol must be reversed
5	Illumination requirements: Schedule 17, item 4

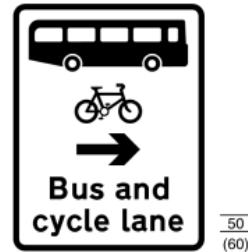

962.2  
Contra-flow bus lane which pedal cycles may also use on road at junction ahead

Item	
1	Regulations: 23, 24
2	Directions: 7
3	Diagrams: None
4	Permitted variants: Schedule 16, items 13, 14, 28, 38 Where the arrow is omitted the word "lane" shall be varied to "lanes" and the symbols reversed
5	Illumination requirements: Schedule 17, item 4



**Status:** This is the original version (as it was originally made). This item of legislation is currently only available in its original format.

SCHEDULE 5 SIGNS FOR BUS, TRAM AND PEDAL CYCLE FACILITIES (contd.)



(40)  
50

963  
Bus lane with traffic proceeding from right  
(Sign for pedestrians)

Item	
1	Regulations: 23, 24
2	Directions: 7
3	Diagrams: None
4	Permitted variants: Schedule 16, item 28 "RIGHT" may be varied to "LEFT" or "BOTH WAYS". "LANE" may be varied to "LANES"
5	Illumination requirements: Schedule 17, item 9



(40)  
50

963.1  
Cycle lane with traffic proceeding from right  
(Sign for pedestrians)

Item	
1	Regulations: None
2	Directions: None
3	Diagrams: None
4	Permitted variants: Schedule 16, item 28 "RIGHT" may be varied to "LEFT" or "BOTH WAYS". "LANE" may be varied to "LANES" or "TRACK"
5	Illumination requirements: Schedule 17, item 9



(40)  
50

963.2  
Contra-flow bus lane which pedal cycles may also use with traffic proceeding from right  
(Sign for pedestrians)

Item	
1	Regulations: 23, 24
2	Directions: 7
3	Diagrams: None
4	Permitted variants: Schedule 16, item 28 "RIGHT" may be varied to "LEFT" or "BOTH WAYS". "LANE" may be varied to "LANES"
5	Illumination requirements: Schedule 17, item 9



(40)  
50

963.3  
Tramway with traffic proceeding in both directions  
(Sign for pedestrians)

Item	
1	Regulations: None
2	Directions: 7
3	Diagrams: None
4	Permitted variants: "BOTH WAYS" may be varied to "LEFT" or "RIGHT"
5	Illumination requirements: Schedule 17, item 9

**Status:** This is the original version (as it was originally made). This item of legislation is currently only available in its original format.

SCHEDULE 5 SIGNS FOR BUS, TRAM AND PEDAL CYCLE FACILITIES (contd.)



964  
End of bus lane

Item	
1	Regulations: 23
2	Directions: 7, 10(1), 18(3)
3	Diagrams: 1050
4	Permitted variants: None
5	Illumination requirements: Schedule 17, item 4



965  
End of cycle lane, track or route

Item	
1	Regulations: None
2	Directions: 18(1)
3	Diagrams: 1057, 1058
4	Permitted variants: None
5	Illumination requirements: Schedule 17, item 9



966  
Pedal cyclists to dismount at the end of, or at a break in, a cycle lane, track or route

Item	
1	Regulations: None
2	Directions: None
3	Diagrams: None
4	Permitted variants: None
5	Illumination requirements: Schedule 17, item 9

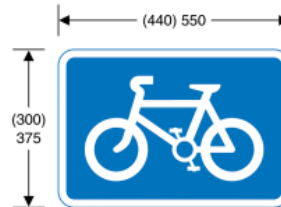

967  
Route recommended for pedal cycles on the main carriageway of a road

Item	
1	Regulations: None
2	Directions: 18(1)
3	Diagrams: 1004, 1004.1, 1057
4	Permitted variants: None
5	Illumination requirements: Schedule 17, item 9

**Status:** This is the original version (as it was originally made). This item of legislation is currently only available in its original format.

SCHEDULE 5 SIGNS FOR BUS, TRAM AND PEDAL CYCLE FACILITIES (contd.)

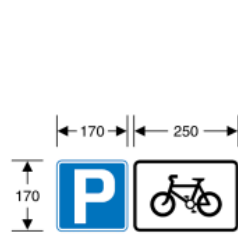

968  
Parking place for pedal cycles

Item	
1	Regulations: None
2	Directions: None
3	Diagrams: None
4	Permitted variants: None
5	Illumination requirements: Schedule 17, item 9



968.1  
Same as diagram 968

Item	
1	Regulations: None
2	Directions: None
3	Diagrams: None
4	Permitted variants: None
5	Illumination requirements: Schedule 17, item 9



969  
Parking place for buses

Item	
1	Regulations: 24(1)
2	Directions: 7, 25
3	Diagrams: 1028.3
4	Permitted variants: None
5	Illumination requirements: Schedule 17, item 4

**Status:** This is the original version (as it was originally made). This item of legislation is currently only available in its original format.

SCHEDULE 5 SIGNS FOR BUS, TRAM AND PEDAL CYCLE FACILITIES (contd.)

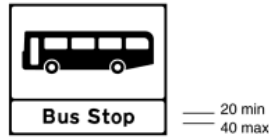

970  
Stopping place for buses

Item	
1	Regulations: 13(2), 13(4), 13(7), 22, 24(1)
2	Directions: 42(1), 42(4)
3	Diagrams: 1025.1, 1025.3, 1025.4
4	Permitted variants: See note. The bus symbol may be omitted. "Request" may be inserted before "Bus Stop". "Stop" may be varied to "Stand". "Bus Stop" may be varied to "Request Stop" when the bus symbol is shown. The legend may be in capital letters. The background, symbol and lettering may be in any contrasting colours. The face of the sign may be curved
5	Illumination requirements: Schedule 17, item 9

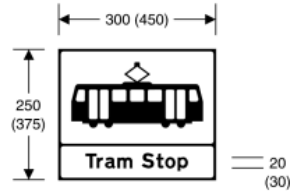

971  
Stopping place for trams

Item	
1	Regulations: 13(2), 13(4), 13(7)
2	Directions: 42(1), 42(4)
3	Diagrams: None
4	Permitted variants: See note under diagram 970. "Tram" may be varied to "Request". The face of the sign may be curved
5	Illumination requirements: Schedule 17, item 9

Note: Supplementary plates may be added to diagrams 970 - 973.3 to give additional information, e.g. bus route numbers, the name of the stopping place or boarding point and a reference to a telephone enquiry line

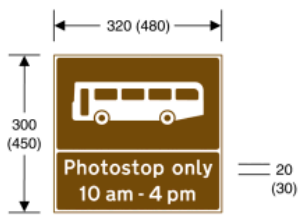

972  
Stopping place for buses used for carrying tourists to allow passengers to take photographs

Item	
1	Regulations: 24(1)
2	Directions: 42(1), 42(4)
3	Diagrams: None
4	Permitted variants: Schedule 16, item 38 See note under diagram 970. The face of the sign may be curved
5	Illumination requirements: Schedule 17, item 9

**Status:** This is the original version (as it was originally made). This item of legislation is currently only available in its original format.

SCHEDULE 5 SIGNS FOR BUS, TRAM AND PEDAL CYCLE FACILITIES (contd.)



973.2  
Stopping place for buses operated by or on behalf of or under agreement with Transport for London

Item	
1	Regulations: 13(2), 13(4), 13(7), 22
2	Directions: 42(1), 42(4)
3	Diagrams: 1025.1, 1025.3, 1025.4
4	Permitted variants: See note under diagram 970. "BUS STOP" may be varied to "BUS STAND". The face of the sign may be curved
5	Illumination requirements: Schedule 17, item 9



973.3  
Same as diagram 973.2

Item	
1	Regulations: 13(2), 13(4), 13(7), 22
2	Directions: 42(1), 42(4)
3	Diagrams: 1025.1, 1025.3, 1025.4
4	Permitted variants: See note under diagram 970. The face of the sign may be curved
5	Illumination requirements: Schedule 17, item 9



974  
Stopping by vehicles other than buses prohibited during the period indicated

Item	
1	Regulations: 22
2	Directions: 24(1), 24(2), 25
3	Diagrams: 1025.1, 1025.3, 1025.4
4	Permitted variants: Schedule 16, item 38 "except buses" may be varied to "except local buses"
5	Illumination requirements: Schedule 17, item 4



975  
Place where buses may stand and the stopping of other vehicles is prohibited during the period indicated

Item	
1	Regulations: 22
2	Directions: 24(1), 24(2), 25
3	Diagrams: 1025.1, 1025.3, 1025.4
4	Permitted variants: Schedule 16, item 38 Same as diagram 974
5	Illumination requirements: Schedule 17, item 4

**Status:** This is the original version (as it was originally made). This item of legislation is currently only available in its original format.

SCHEDULE 5 SIGNS FOR BUS, TRAM AND PEDAL CYCLE FACILITIES (contd.)

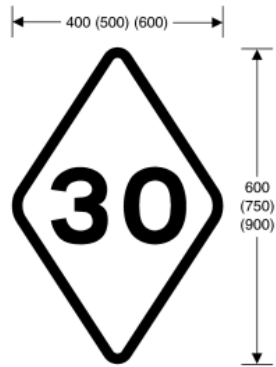

976  
Maximum speed limit for tramcars  
in kilometres per hour

Item	
1	Regulations: None
2	Directions: None
3	Diagrams: None
4	Permitted variants: The numeral "30" may be varied. Other information may be substituted for "30" in accordance with the requirements of Her Majesty's Railway Inspectorate. The background, border, symbol and lettering may be in any colour in accordance with the requirements of Her Majesty's Railway Inspectorate
5	Illumination requirements: Schedule 17, item 9

**Status:** This is the original version (as it was originally made). This item of legislation is currently only available in its original format.

## SCHEDULE 6 ROAD MARKINGS

### SCHEDULE 6 ROAD MARKINGS

Regulation 11(1) and (3)



**1001**  
Vehicular traffic must not proceed beyond the line when required to stop by light signals, by a constable in uniform or by a traffic warden

Item	
1	Regulations: 31, 43, 52
2	Directions: 18(1), 47
3	Diagrams: 1001.3, 1055.1, 1055.2, 3000, 3000.1, 3000.2, 3000.7, 3000.8, 3000.9, 3000.10, 3013, 3014
4	Permitted variants: None
5	Illumination requirements: Schedule 17, item 12

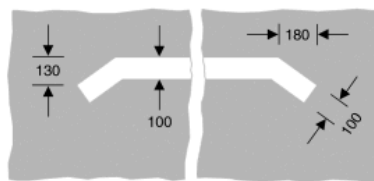

**1001.1**  
Tramcars must not proceed beyond the line when required to stop by light signals

Item	
1	Regulations: 31, 43
2	Directions: 18(1)
3	Diagrams: 3013
4	Permitted variants: None
5	Illumination requirements: Schedule 17, item 12

**Status:** This is the original version (as it was originally made). This item of legislation is currently only available in its original format.

SCHEDULE 6 ROAD MARKINGS (contd.)

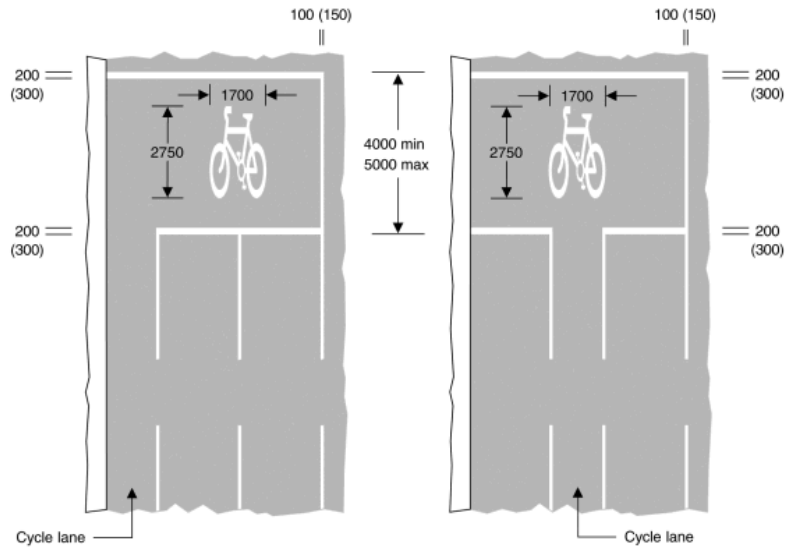

1001.2

Alternatives to the stop line shown in diagram 1001 showing separate stop lines at a junction for pedal cycles proceeding in the cycle lane

Item	
1	Regulations: 12(4), 31, 43
2	Directions: 18(1), 18(2), 47
3	Diagrams: 1004, 1004.1, 1057, 3000, 3000.7, 3000.8, 3000.9, 3000.10
4	Permitted variants: The number of traffic lanes may be varied. The nearside cycle lane may be bounded by the continuous white line shown in diagram 1049. The right hand longitudinal line may be omitted where that part of the carriageway is delineated by a raised kerb
5	Illumination requirements: Schedule 17, item 12



**Status:** This is the original version (as it was originally made). This item of legislation is currently only available in its original format.

SCHEDULE 6 ROAD MARKINGS (contd.)

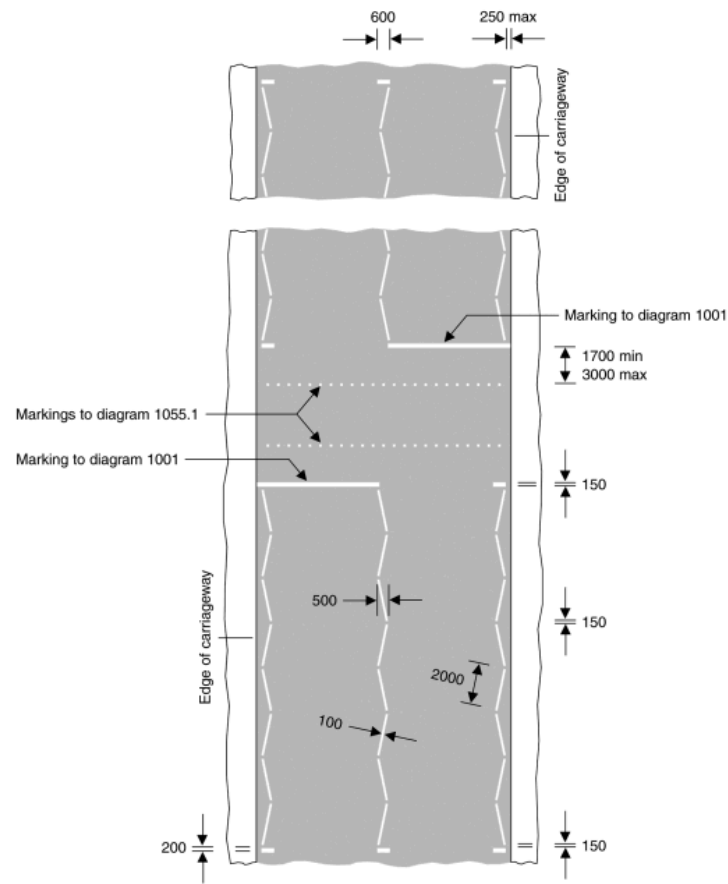

1001.3  
Zig-zag lines to indicate the requirements of regulations 27 and 28 at a Toucan or equestrian crossing facility controlled by signals (Shown in combination with diagrams 1001 and 1055.1)

Item	
1	Regulations: 4, 10(1), 10(2), 27, 28, 31(1)
2	Directions: 18(1), 49
3	Diagrams: 1001, 1055.1, 1055.2, 4002.1, 4003.1, 4003.2, 4003.4, 4003.5, 4003.7
4	Permitted variants: The marking and layout may be varied as prescribed in Schedule 4 to the Zebra, Pelican and Puffin Pedestrian Crossings Regulations and General Directions 1997 and shall comply with any requirements therein. Diagram 1055.2 may be substituted for diagram 1055.1
5	Illumination requirements: Schedule 17, item 12

**Status:** This is the original version (as it was originally made). This item of legislation is currently only available in its original format.

SCHEDULE 6 ROAD MARKINGS (contd.)



1002.1  
Vehicular traffic must not proceed beyond the line when required to stop by the sign shown in diagram 601.1

Item	
1	Regulations: 16, 31
2	Directions: 17, 18(3)
3	Diagrams: 601.1, 1022
4	Permitted variants: None
5	Illumination requirements: Schedule 17, item 12

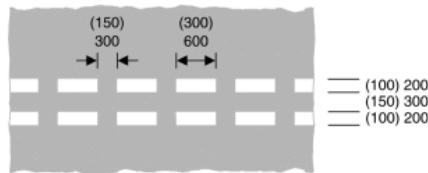

1003  
Vehicular traffic must give way in accordance with the requirements of regulation 25

Item	
1	Regulations: 4, 10(1), 16, 25, 31
2	Directions: 17, 18(1), 18(3), 18(5), 18(6), 34
3	Diagrams: 602, 611.1, 615, 955, 956, 957, 960.1, 1003.4, 1009, 1023, 1057
4	Permitted variants: None
5	Illumination requirements: Schedule 17, item 12

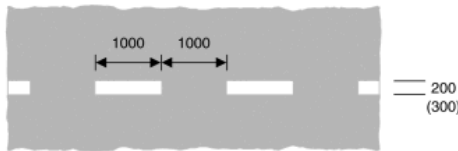

1003.1  
Vehicular traffic approaching a roundabout should give way at or immediately beyond the line to vehicular traffic circulating on the carriageway of the roundabout

Item	
1	Regulations: 31
2	Directions: None
3	Diagrams: None
4	Permitted variants: None
5	Illumination requirements: Schedule 17, item 12

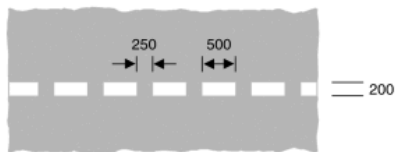

1003.2  
Pedestrians approaching a level crossing must wait behind the line when the barriers are closed or when the red figure shown in diagram 4006 or the light signals shown in diagram 3014 are showing or, if there are neither barriers nor light signals, until satisfied that it is safe to proceed

Item	
1	Regulations: 40, 52
2	Directions: None
3	Diagrams: 3014, 4006
4	Permitted variants: None
5	Illumination requirements: Schedule 17, item 12

**Status:** This is the original version (as it was originally made). This item of legislation is currently only available in its original format.

SCHEDULE 6 ROAD MARKINGS (contd.)

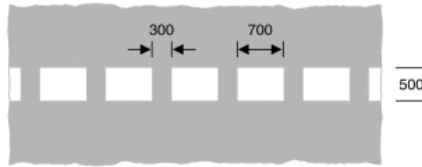

Item	
1	Regulations: 16, 31
2	Directions: 17, 18(1), 18(3)
3	Diagrams: 611.1, 1003.4, 1023
4	Permitted variants: None
5	Illumination requirements: Schedule 17, item 12

1003.3

Vehicular traffic approaching a roundabout with small central island or approaching a junction marked by signs as shown in diagram 611.1 should give way at or immediately beyond the line to traffic circulating on the carriageway of the roundabout

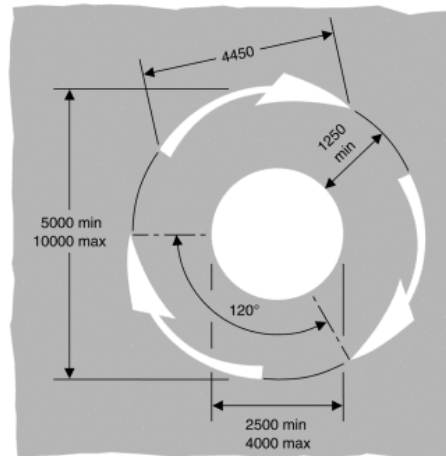
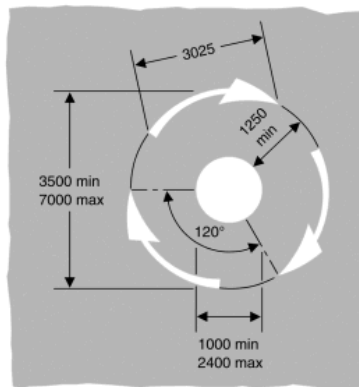

1003.4

Marking used in conjunction with the sign shown in diagram 611.1 and conveying the requirements prescribed by regulation 16 (Alternative types)

Item	
1	Regulations: 12(6), 16, 25, 31, 32(2)
2	Directions: 17, 18(1), 18(3)
3	Diagrams: 602, 611.1, 1003, 1003.3, 1023
4	Permitted variants: None
5	Illumination requirements: Schedule 17, item 12

**Status:** This is the original version (as it was originally made). This item of legislation is currently only available in its original format.

SCHEDULE 6 ROAD MARKINGS (contd.)

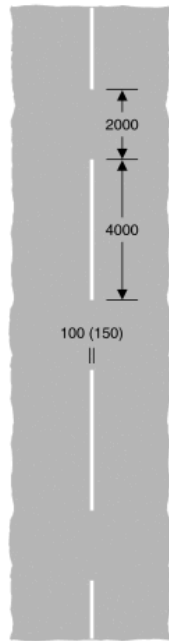

1004

Vehicular traffic on roads with a speed limit of 40 mph or less should not cross or straddle the line unless it is safe to do so, and when the line is used in conjunction with the sign in diagram 967 motor vehicles should not enter a cycle lane unless that lane is clear of pedal cycles

Item	
1	Regulations: 4, 31
2	Directions: 18(1)
3	Diagrams: 967, 1001.2, 1057, 1062
4	Permitted variants: None
5	Illumination requirements: Schedule 17, item 12

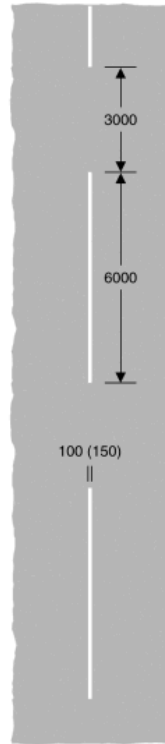

1004.1

As diagram 1004 on roads with a speed limit of more than 40 mph

Item	
1	Regulations: 4, 31
2	Directions: 18(1)
3	Diagrams: 967, 1001.2, 1057
4	Permitted variants: None
5	Illumination requirements: Schedule 17, item 12

**Status:** This is the original version (as it was originally made). This item of legislation is currently only available in its original format.

SCHEDULE 6 ROAD MARKINGS (contd.)

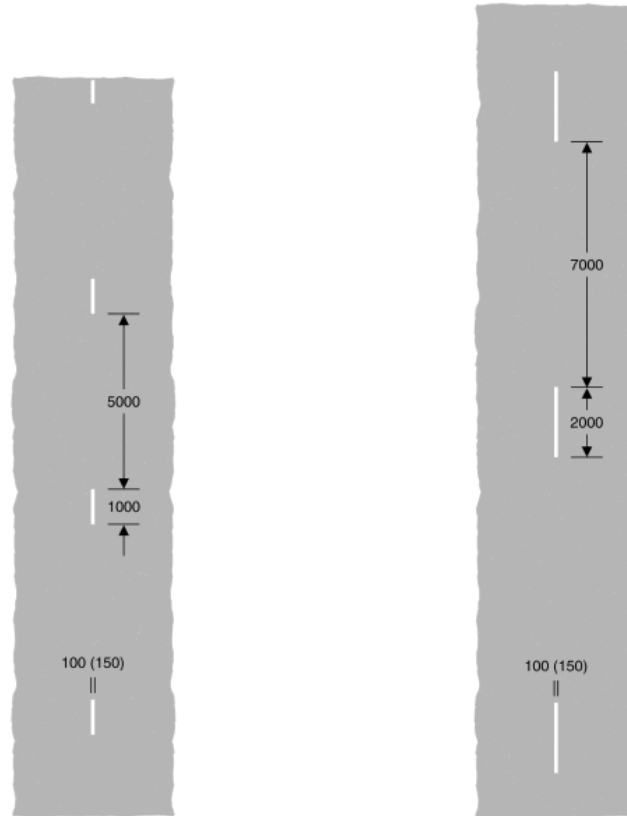

1005

Division of carriageway into traffic lanes on the part of the carriageway where vehicles normally proceed in the same direction on roads with a speed limit of 40 mph or less other than at places where the marking shown in diagram 1004 is used

Item	
1	Regulations: 4, 31
2	Directions: None
3	Diagrams: None
4	Permitted variants: None
5	Illumination requirements: Schedule 17, item 12

1005.1

As diagram 1005 on roads with a speed limit of more than 40 mph other than at places where the marking shown in diagram 1004.1 is used

Item	
1	Regulations: 4, 31
2	Directions: None
3	Diagrams: None
4	Permitted variants: None
5	Illumination requirements: Schedule 17, item 12

**Status:** This is the original version (as it was originally made). This item of legislation is currently only available in its original format.

SCHEDULE 6 ROAD MARKINGS (contd.)

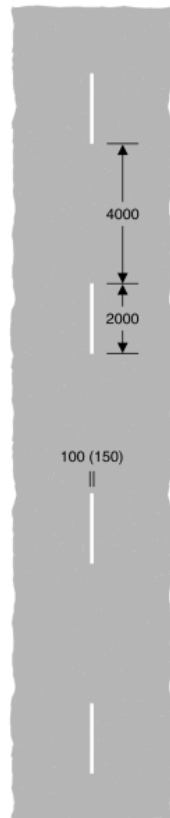

1008

Division between opposing flows of traffic on a carriageway with a speed limit of 40 mph or less other than at places where the marking shown in diagram 1004 is used

Item	
1	Regulations: 4, 31
2	Directions: None
3	Diagrams: None
4	Permitted variants: None
5	Illumination requirements: Schedule 17, item 12

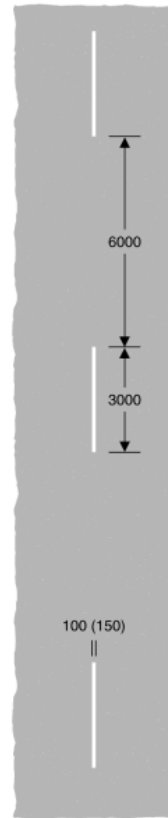

1008.1

Division between opposing flows of traffic on a carriageway with a speed limit of more than 40 mph other than at places where the marking shown in diagram 1004.1 is used

Item	
1	Regulations: 4, 31
2	Directions: None
3	Diagrams: None
4	Permitted variants: None
5	Illumination requirements: Schedule 17, item 12

**Status:** This is the original version (as it was originally made). This item of legislation is currently only available in its original format.

SCHEDULE 6 ROAD MARKINGS (contd.)

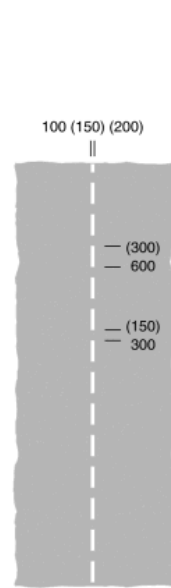

1009

Edge of the carriageway at a road junction, exit from a private drive onto a public road, or where laid diagonally across part of the carriageway, the start of a cycle lane

Item	
1	Regulations: 4, 12(3), 31
2	Directions: 17, 18(6)
3	Diagrams: 958.1, 1003, 1023
4	Permitted variants: None
5	Illumination requirements: Schedule 17, item 12

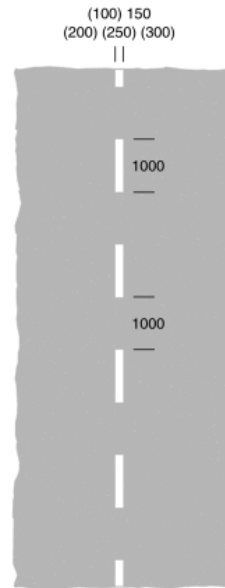

1010

- (a) Edge of the carriageway at a road junction or a lay-by, or at an exit from a private drive onto a public road; or
- (b) where laid diagonally across part of the carriageway, the start of a traffic lane, the boundary of which is indicated by diagram 1049; or
- (c) when used in conjunction with diagrams 1014 and 1024.1, the most suitable path to be taken by high vehicles under a low bridge or to avoid an overhanging structure; or
- (d) when laid alongside rails used by tramcars, the edge of the part of the carriageway used by the tramcars; or
- (e) the division between the main carriageway and a traffic lane which leaves the main carriageway at a junction ahead

Item	
1	Regulations: 4, 31
2	Directions: 17, 18(3)
3	Diagrams: 508.1, 509.1, 958, 1014, 1024.1, 1049
4	Permitted variants: None
5	Illumination requirements: Schedule 17, item 12

**Status:** This is the original version (as it was originally made). This item of legislation is currently only available in its original format.

SCHEDULE 6 ROAD MARKINGS (contd.)



1012.1

- (a) Edge of the carriageway available for through traffic other than at a road junction, an exit from a private drive onto a public road or a lay-by; or
- (b) the back edge of a hard shoulder; or
- (c) the edge of a footway where it passes over a railway or tramway level crossing

Item	
1	Regulations: 31
2	Directions: 18(1)
3	Diagrams: 1062
4	Permitted variants: The width of the line shall be 100 millimetres when it is used to delineate the back edge of a hard shoulder
5	Illumination requirements: Schedule 17, item 12



**Status:** This is the original version (as it was originally made). This item of legislation is currently only available in its original format.

SCHEDULE 6 ROAD MARKINGS (contd.)

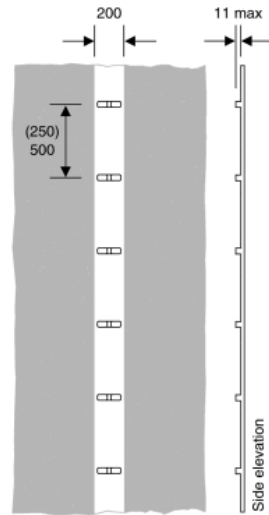

1012.2

Alternative to the marking shown in diagram 1012.1, as described in caption (a) to that diagram, incorporating an audible and tactile warning in the form of a raised rib for use on motorways

Item	
1	Regulations: 11(2), 31, 32(2)
2	Directions: 14(1)
3	Diagrams: None
4	Permitted variants: The notch may be omitted from the raised rib
5	Illumination requirements: Schedule 17, item 12

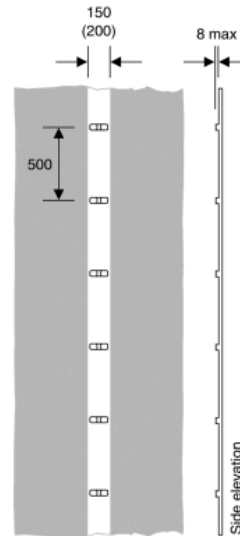

1012.3

As diagram 1012.2 for use on roads that are not motorways and which have hard strips or hard shoulders

Item	
1	Regulations: 11(2), 31, 32(2)
2	Directions: 13(3)
3	Diagrams: None
4	Permitted variants: The notch may be omitted from the raised rib. The width of the line shall be 200 millimetres when used on roads with hard shoulders
5	Illumination requirements: Schedule 17, item 12

**Status:** This is the original version (as it was originally made). This item of legislation is currently only available in its original format.

SCHEDULE 6 ROAD MARKINGS (contd.)

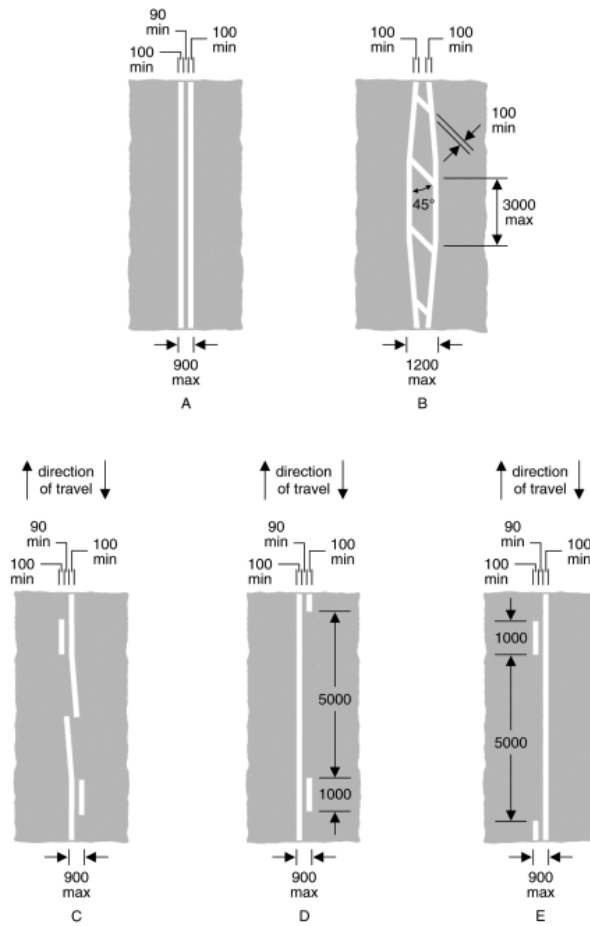

1013.1

Alternative methods of indicating to vehicular traffic the requirements and the warning prescribed in regulation 26

Item	
1	Regulations: 4, 10(1), 10(2), 26, 31
2	Directions: 18(1), 48
3	Diagrams: 1014, 1045 (when diagram 1013.1 is as shown in version A)
4	Permitted variants: None
5	Illumination requirements: Schedule 17, item 12

**Status:** This is the original version (as it was originally made). This item of legislation is currently only available in its original format.

SCHEDULE 6 ROAD MARKINGS (contd.)

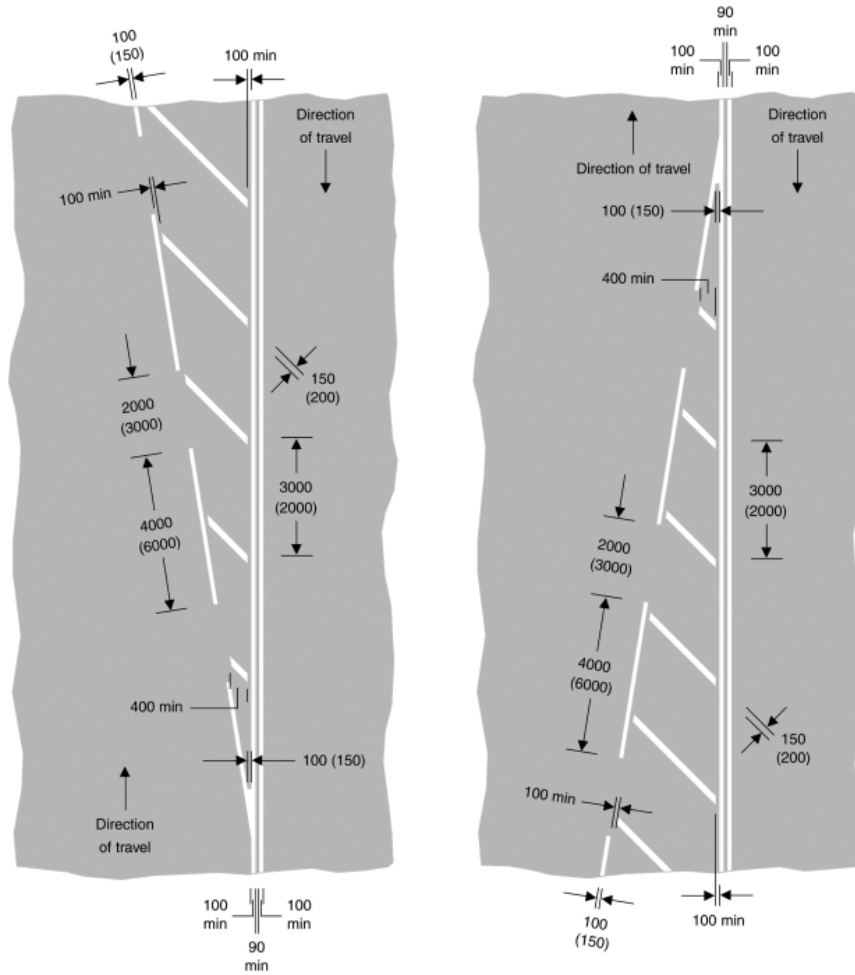

1013.3

As diagram 1013.1, with an adjacent part of the carriageway which vehicular traffic should not enter unless it is seen by the driver to be safe to do so

Item	
1	Regulations: 4, 10(1), 10(2), 12(4), 26, 31
2	Directions: 48
3	Diagrams: 1013.4, 1014
4	Permitted variants: None
5	Illumination requirements: Schedule 17, item 12

**Status:** This is the original version (as it was originally made). This item of legislation is currently only available in its original format.

SCHEDULE 6 ROAD MARKINGS (contd.)

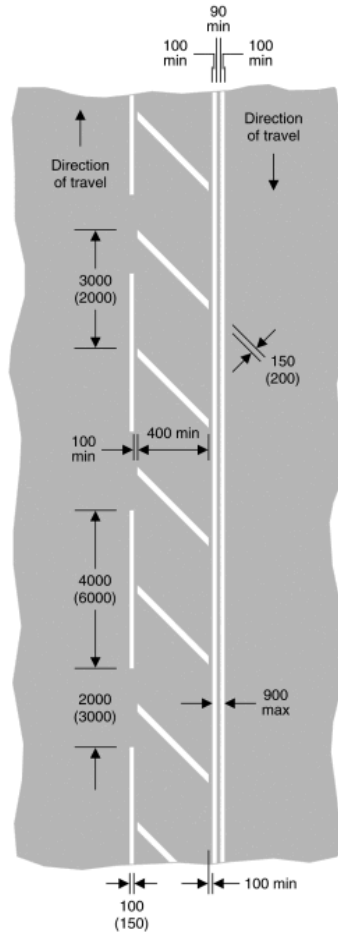

1013.4  
Same as diagram 1013.3

Item	
1	Regulations: 4, 10(1), 10(2), 12(4), 26, 31
2	Directions: None
3	Diagrams: 1013.3
4	Permitted variants: None
5	Illumination requirements: Schedule 17, item 12

**Status:** This is the original version (as it was originally made). This item of legislation is currently only available in its original format.

SCHEDULE 6 ROAD MARKINGS (contd.)

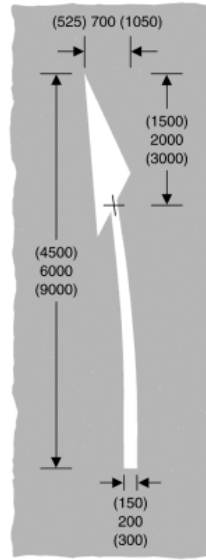

1014

- (a) Direction in which vehicular traffic should pass a road marking shown in diagram 1013.1, 1013.3, 1040, 1040.3, 1040.4 or 1049 ahead; or
- (b) obstruction on the carriageway ahead; or
- (c) when used in conjunction with the marking shown in diagram 1010, the most suitable path to be taken by high vehicles under a low bridge or to avoid an overhanging structure; or
- (d) reduction in the number of traffic lanes on the carriageway ahead; or
- (e) path to be taken by vehicular traffic to avoid a route available for trams only

Item	
1	Regulations: 31
2	Directions: 18(3), 48
3	Diagrams: 1010, 1013.1, 1013.3, 1024.1, 1040, 1040.3, 1040.4, 1049
4	Permitted variants: The symbol may be reversed in a mirror image
5	Illumination requirements: Schedule 17, item 12

**Status:** This is the original version (as it was originally made). This item of legislation is currently only available in its original format.

SCHEDULE 6 ROAD MARKINGS (contd.)

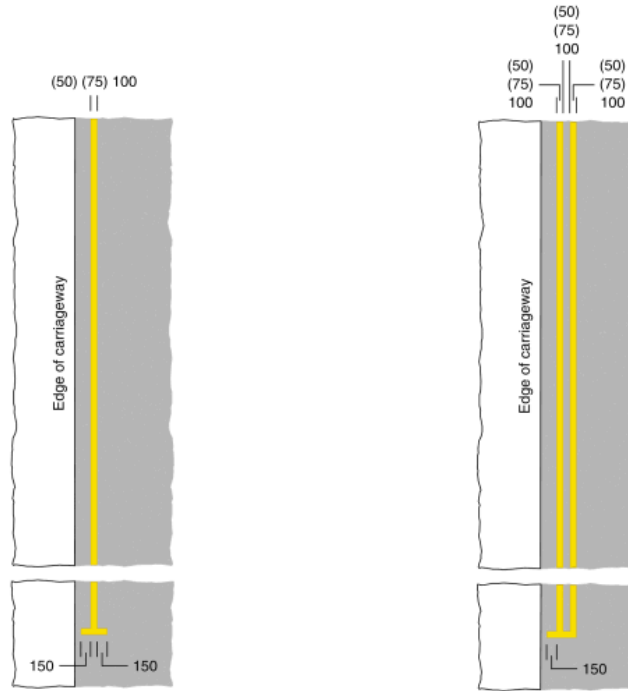

1017  
Waiting of vehicles on a side of a length of road prohibited for a time less than that specified in caption (a) to diagram 1018.1

1018.1  
(a) Waiting of vehicles on a side of a length of road prohibited at any time during a period of at least 4 consecutive months; or  
(b) Stopping of vehicles in a lay-by prohibited except in emergency

Item	
1	Regulations: 4
2	Directions: 7, 18(1), 22, 24(1), 24(4), 25
3	Diagrams: 637.2, 639, 639.1B, 640, 650.3, 663, 663.1, 1062
4	Permitted variants: None
5	Illumination requirements: Schedule 17, item 12

Item	
1	Regulations: 4
2	Directions: 7, 18(1), 22, 24(1), 24(4)
3	Diagrams: 637.2, 637.3, 640, 642.3, 650.3, 663, 663.1, 1062
4	Permitted variants: None
5	Illumination requirements: Schedule 17, item 12

**Status:** This is the original version (as it was originally made). This item of legislation is currently only available in its original format.

SCHEDULE 6 ROAD MARKINGS (contd.)

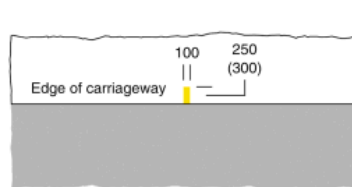

1019  
Loading and unloading of vehicles on a side of a length of road prohibited for a time less than that specified in the caption to diagram 1020.1

Item	
1	Regulations: 4
2	Directions: 7, 23, 24(1), 24(4), 25
3	Diagrams: 637.2, 638.1, 639.1B, 640, 663, 663.1
4	Permitted variants: The marking may be continued down the vertical face of a kerb at the edge of the carriageway
5	Illumination requirements: Schedule 17, item 12

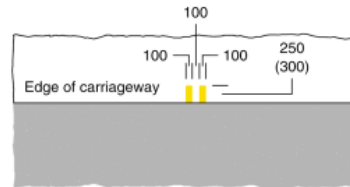

1020.1  
Loading and unloading of vehicles on a side of a length of road prohibited at any time during a period of at least 4 consecutive months

Item	
1	Regulations: 4
2	Directions: 7, 23, 24(1), 24(4), 25
3	Diagrams: 637.2, 638, 640, 663, 663.1
4	Permitted variants: Same as diagram 1019
5	Illumination requirements: Schedule 17, item 12



1022  
Approach to a road junction or level crossing at or near which is placed the sign shown in diagram 601.1 and the road marking shown in diagram 1002.1

Item	
1	Regulations: 31
2	Directions: 17, 18(3)
3	Diagrams: 601.1, 1002.1
4	Permitted variants: None
5	Illumination requirements: Schedule 17, item 12

**Status:** This is the original version (as it was originally made). This item of legislation is currently only available in its original format.

SCHEDULE 6 ROAD MARKINGS (contd.)

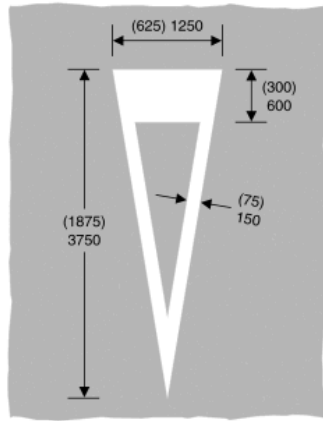

1023  
Approach to a road junction, level crossing or road narrowing at or near which is placed the marking shown in diagram 1003 or 1003.3

Item	
1	Regulations: 25, 31
2	Directions: 17, 18(1), 18(3), 18(5), 18(6), 34(1)
3	Diagrams: 602, 611.1, 615, 955, 956, 957, 960.1, 1003, 1003.3, 1003.4, 1009, 1057
4	Permitted variants: None
5	Illumination requirements: Schedule 17, item 12

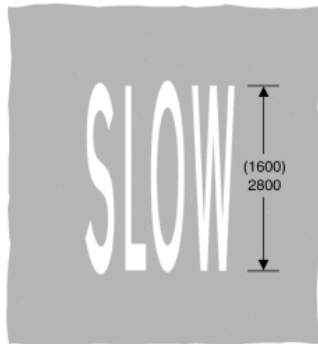

1024  
Vehicular traffic should proceed with caution because of potential danger ahead

Item	
1	Regulations: 31
2	Directions: None
3	Diagrams: None
4	Permitted variants: None
5	Illumination requirements: Schedule 17, item 12

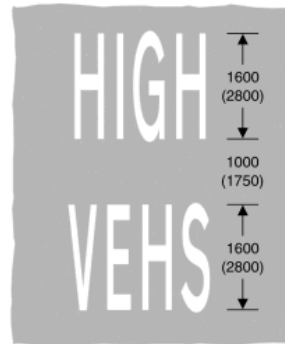

1024.1  
Path to be taken by high vehicles under a low bridge or to avoid an overhanging structure

Item	
1	Regulations: 31
2	Directions: 18(3)
3	Diagrams: 1010, 1014
4	Permitted variants: None
5	Illumination requirements: Schedule 17, item 12



**Status:** This is the original version (as it was originally made). This item of legislation is currently only available in its original format.

SCHEDULE 6 ROAD MARKINGS (contd.)

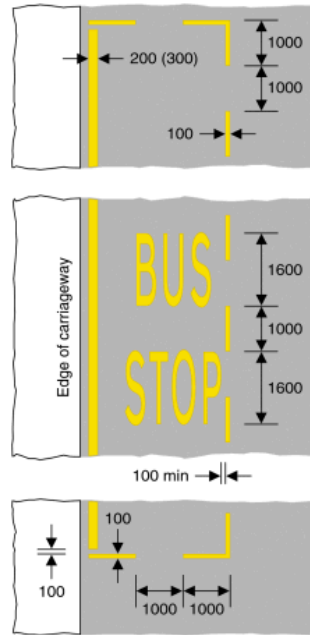

1025.1

Bus stop at which vehicular traffic must comply with the requirements of regulation 29(1) and Part I of Schedule 19

Item	
1	Regulations: 10(1), 22, 29(1)
2	Directions: 22(3), 24(1), 25
3	Diagrams: 970, 973.2, 973.3, 974, 975
4	Permitted variants: *STOP* may be varied to *STAND*
5	Illumination requirements: Schedule 17, item 12

**Status:** This is the original version (as it was originally made). This item of legislation is currently only available in its original format.

SCHEDULE 6 ROAD MARKINGS (contd.)

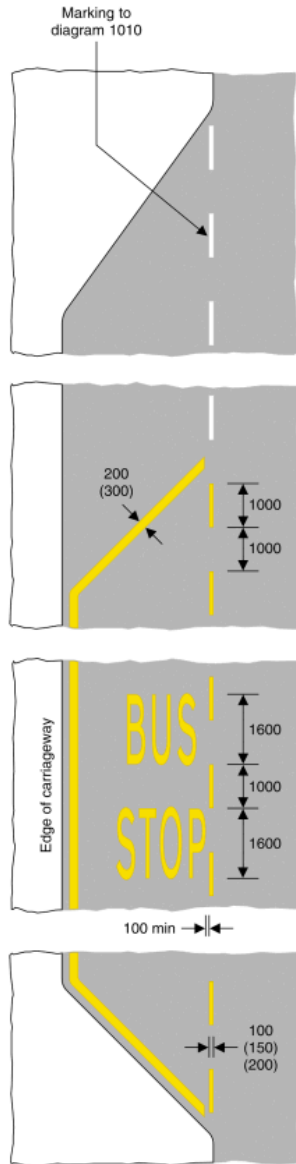

1025.3

Same as diagram 1025.1 but where the bus stop is located in part of a lay-by, the other part of which may be used by other vehicles

Item	
1	Regulations: 10(1), 22, 29(1), 31(5), 31(7)
2	Directions: 22(3), 24(1), 25
3	Diagrams: 970, 973.2, 973.3, 974, 975
4	Permitted variants: "STOP" may be varied to "STAND". The shape of the marking may be varied
5	Illumination requirements: Schedule 17, item 12

**Status:** This is the original version (as it was originally made). This item of legislation is currently only available in its original format.

SCHEDULE 6 ROAD MARKINGS (contd.)

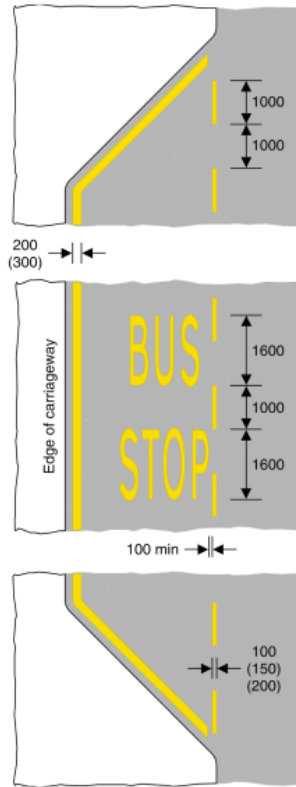

1025.4

Same as diagram 1025.1 but where the bus stop occupies the whole of a lay-by

Item	
1	Regulations: 10(1), 22, 29(1), 31(5), 31(7)
2	Directions: 22(3), 24(1), 25
3	Diagrams: 970, 973.2, 973.3, 974, 975
4	Permitted variants: Same as diagram 1025.3
5	Illumination requirements: Schedule 17, item 12

**Status:** This is the original version (as it was originally made). This item of legislation is currently only available in its original format.

SCHEDULE 6 ROAD MARKINGS (contd.)

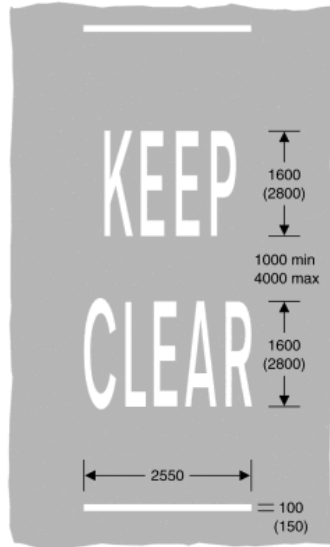

1026  
Part of the carriageway which should be kept clear of stationary vehicles

Item	
1	Regulations: None
2	Directions: None
3	Diagrams: None
4	Permitted variants: The white line indicating the extent of the area to be kept clear may be omitted
5	Illumination requirements: Schedule 17, item 12

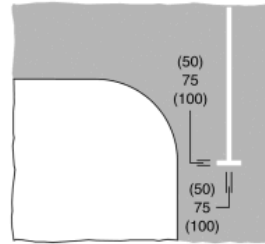
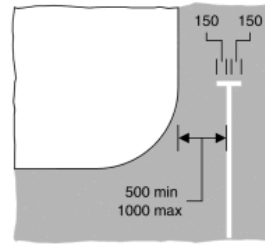

1026.1  
Part of the carriageway outside an entrance to off-street premises or a private drive, or where the kerb is dropped to provide a convenient crossing place for pedestrians, which should be kept clear of waiting vehicles

Item	
1	Regulations: None
2	Directions: None
3	Diagrams: None
4	Permitted variants: None
5	Illumination requirements: Schedule 17, item 12

**Status:** This is the original version (as it was originally made). This item of legislation is currently only available in its original format.

SCHEDULE 6 ROAD MARKINGS (contd.)

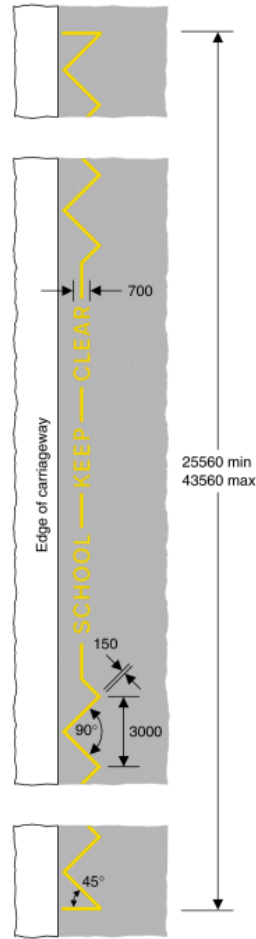

1027.1  
Part of the carriageway outside a school entrance where vehicles should not stop

Item	
1	Regulations: None
2	Directions: 22(3), 24(1)
3	Diagrams: 642.2A
4	Permitted variants: The word "SCHOOL" may be varied to "CHILDREN" and the maximum length of the marking increased to 44545 millimetres. The word "SCHOOL" shall be omitted and the minimum length of the marking reduced to 25250 millimetres when used outside a fire, police or ambulance station, or a hospital. The overall length of the marking shall be varied within the specified limits by the addition or removal of an equal number of complete zig-zag elements on each side of the legend
5	Illumination requirements: Schedule 17, Item 12

**Status:** This is the original version (as it was originally made). This item of legislation is currently only available in its original format.

SCHEDULE 6 ROAD MARKINGS (contd.)

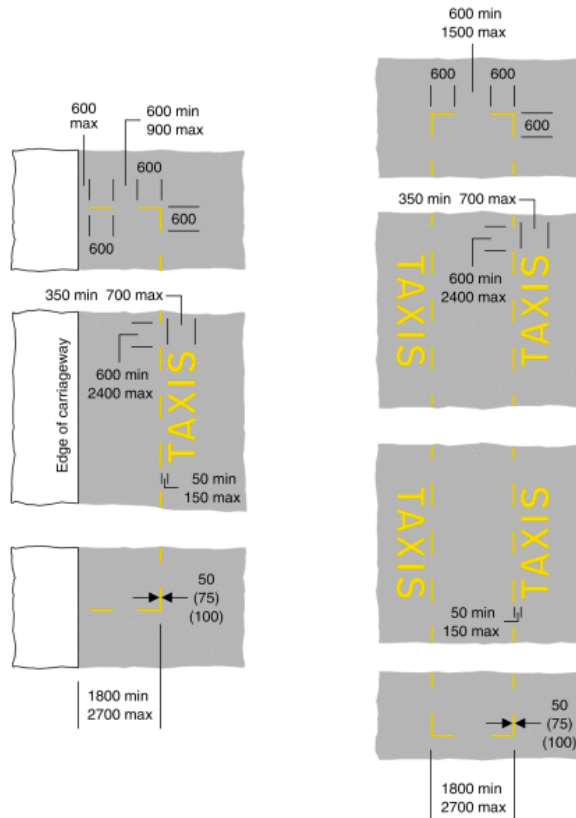

1028.2

Alternative types of taxi rank either at the edge or in the centre of the carriageway

Item	
1	Regulations: 12(6)
2	Directions: 7, 22(3), 24(1), 25
3	Diagrams: 640, 650.1, 650.2, 650.3, 857.1
4	Permitted variants: The number of times the word "TAXIS" is shown may be varied according to the length of the marking. "TAXIS" may be varied to: 1. "AMBULANCES" 2. "POLICE" When the marking is used in conjunction with the sign shown in diagram 650.1, a continuous longitudinal yellow line 200 or 300 millimetres wide shall be placed along the edge of the carriageway in the manner shown in diagram 1025.1. The transverse line may be omitted when the marking is placed in a lay-by or where the end of the bay is delineated by a raised kerb
5	Illumination requirements: Schedule 17, item 12

**Status:** This is the original version (as it was originally made). This item of legislation is currently only available in its original format.

SCHEDULE 6 ROAD MARKINGS (contd.)

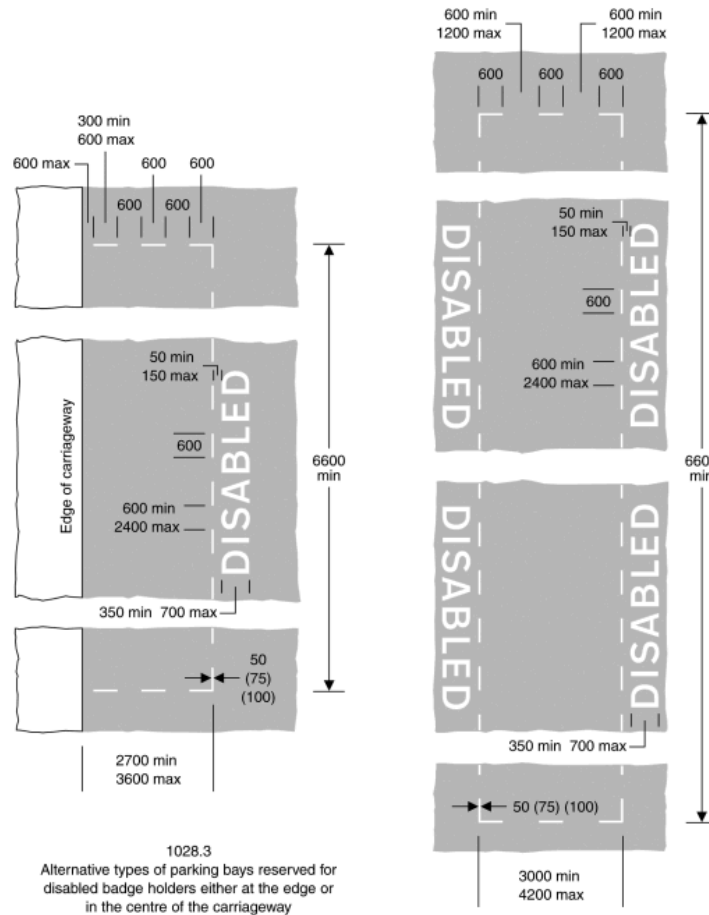

Item	
1	Regulations: 12(6), 22
2	Directions: 7, 24(1), 25
3	Diagrams: 639.1B, 660, 660.4, 661A, 661.1, 786, 801 (when used with 804.1), 969
4	Permitted variants: The number of times the word "DISABLED" is shown may be varied according to the length of the marking. "DISABLED" may be omitted or varied to: 1. "BUSES" 2. "LARGE OR SLOW VEHICLES ONLY" 3. "LOADING ONLY" The minimum width of a bay reserved for disabled badge holders at the edge of the carriageway shall be 1800 millimetres in a case where, on account of the nature of the traffic using the road, the overall width of the carriageway is insufficient to accommodate a wider bay. In such a case, or where the width of the bay is 2700 millimetres, the transverse marking shall be the same as the transverse marking in the edge of carriageway version of diagram 1028.4. The transverse line may be omitted when the marking is placed in a lay-by or where the end of the bay is delineated by a raised kerb
5	Illumination requirements: Schedule 17, item 12

**Status:** This is the original version (as it was originally made). This item of legislation is currently only available in its original format.

SCHEDULE 6 ROAD MARKINGS (contd.)

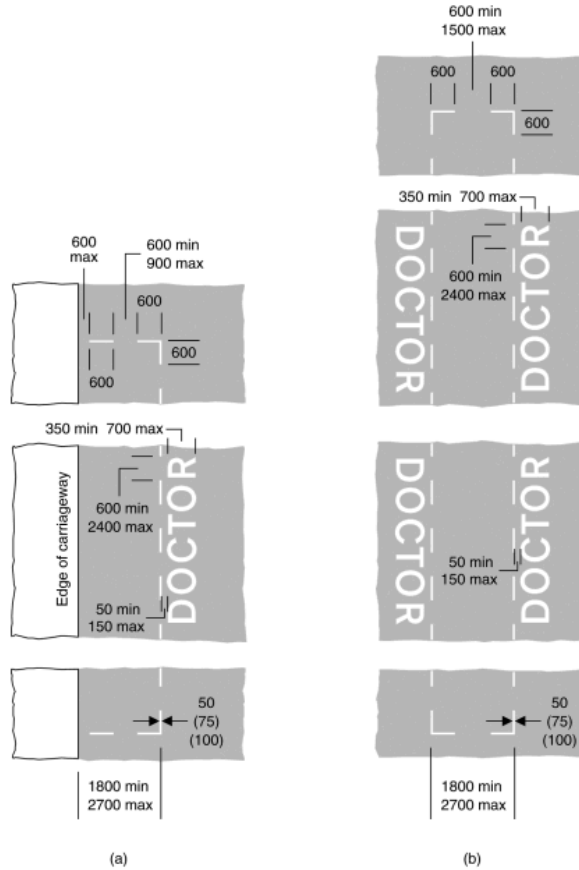

- 1028.4  
Alternative types of parking bays reserved for doctor permit holders
- (a) at the edge of the carriageway and situated wholly on either the carriageway or the footway; or
  - (b) in the centre of the carriageway or partly on the carriageway and partly on the footway

Item	
1	Regulations: 12(6)
2	Directions: 7, 24(1), 25
3	Diagrams: 639.1B, 660, 660.3, 660.5, 660.6, 660.7, 661.1, 661.2A, 661.3A, 662, 663.1, 667, 667.1, 668, 668.1, 801
4	Permitted variants: The number of times the word "DOCTOR" is shown may be varied according to the length of the marking. "DOCTOR" may be omitted or varied to: 1. "SOLO MOTORCYCLES ONLY" 2. "SOLO M/CYCLES ONLY" 3. "SOLO M/CS ONLY" 4. "PERMIT HOLDERS ONLY" The transverse line may be omitted when the marking is placed in a lay-by or where the end of the bay is delineated by a raised kerb. When the marking is placed wholly or partly on the footway any legend shall be placed only on the carriageway side of the bay
5	Illumination requirements: Schedule 17, item 12



**Status:** This is the original version (as it was originally made). This item of legislation is currently only available in its original format.

SCHEDULE 6 ROAD MARKINGS (contd.)

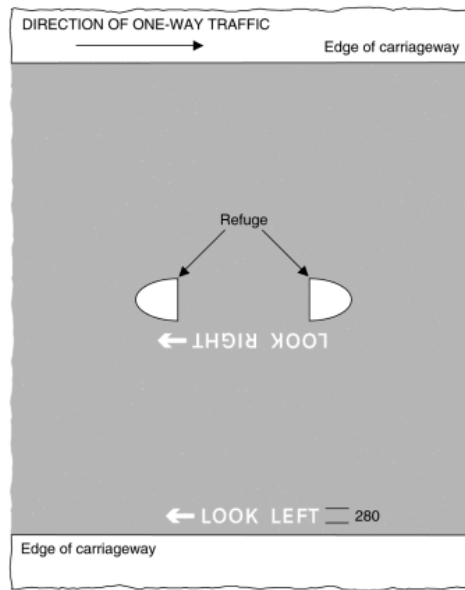

1029  
Direction in which pedestrians should  
look for approaching traffic

Item	
1	Regulations: 27(1)
2	Directions: None
3	Diagrams: None
4	Permitted variants: When used in circumstances other than shown in the diagram the marking shall be varied to accord with the direction of approaching traffic
5	Illumination requirements: Schedule 17, item 12

**Status:** This is the original version (as it was originally made). This item of legislation is currently only available in its original format.

SCHEDULE 6 ROAD MARKINGS (contd.)

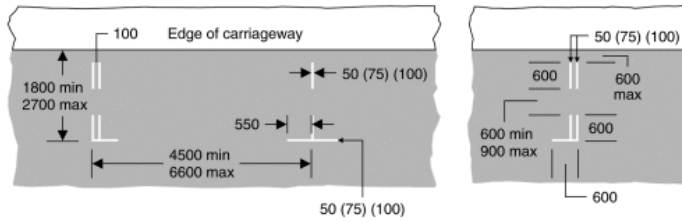

1032  
Parking bay marked with individual parking spaces  
(Longitudinal marking)

Item	
1	Regulations: 12(6)
2	Directions: 7, 24(1), 25
3	Diagrams: 639.1B, 660, 660.3, 660.4, 660.5, 660.6, 660.7, 661A, 661.1, 661.2A, 661.3A, 662, 663.1, 801
4	Permitted variants: The number of individual parking spaces may be extended as necessary. The double transverse lines are only to be used at the end of a block of parking spaces and may be omitted when the marking is placed in a lay-by or where the end of the bay is delineated by a raised kerb. Two adjacent parking spaces may be combined into a single space by omitting the transverse marks between them and giving a maximum length of space of 13200 millimetres. The words "DOCTOR", "DISABLED" or "LOADING ONLY" may be added in the manner shown in diagram 1028.4. The minimum length of a parking space reserved for disabled badge holders shall be 6600 millimetres. The width of such a space shall be 2700 millimetres but this may be reduced to a width not less than 1800 millimetres in a case where, on account of the nature of the traffic using the road, the overall width of the carriageway is insufficient to accommodate a wider bay
5	Illumination requirements: Schedule 17, item 12

**Status:** This is the original version (as it was originally made). This item of legislation is currently only available in its original format.

SCHEDULE 6 ROAD MARKINGS (contd.)

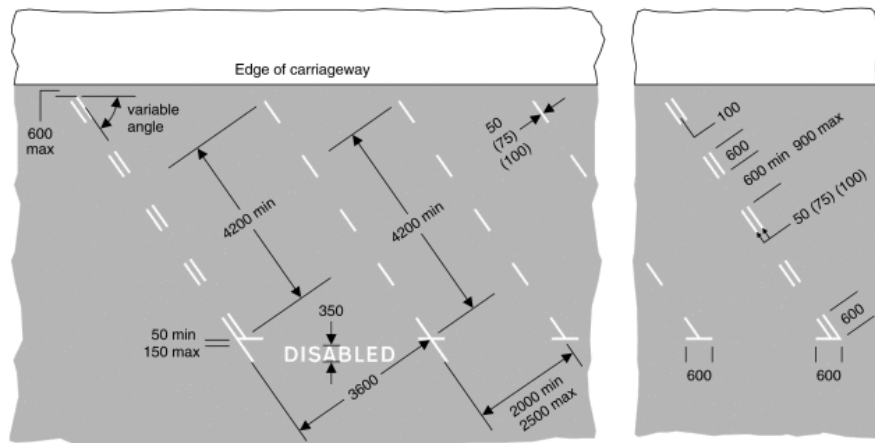

1033  
Echelon parking spaces subject to such conditions,  
if any, as may be in force

Item	
1	Regulations: 12(6)
2	Directions: 7, 24(1), 25
3	Diagrams: 639.1B, 660, 660.3, 660.4, 660.5, 660.6, 660.7, 661A, 661.1, 661.2A, 661.3A, 662, 663.1, 801
4	Permitted variants: "DISABLED" and the associated bay may be omitted. Additional "DISABLED" bays may be provided. The word "DOCTOR" may be added. The marking may be omitted along that part of a bay which is delineated by a raised kerb
5	Illumination requirements: Schedule 17, item 12

**Status:** This is the original version (as it was originally made). This item of legislation is currently only available in its original format.

SCHEDULE 6 ROAD MARKINGS (contd.)

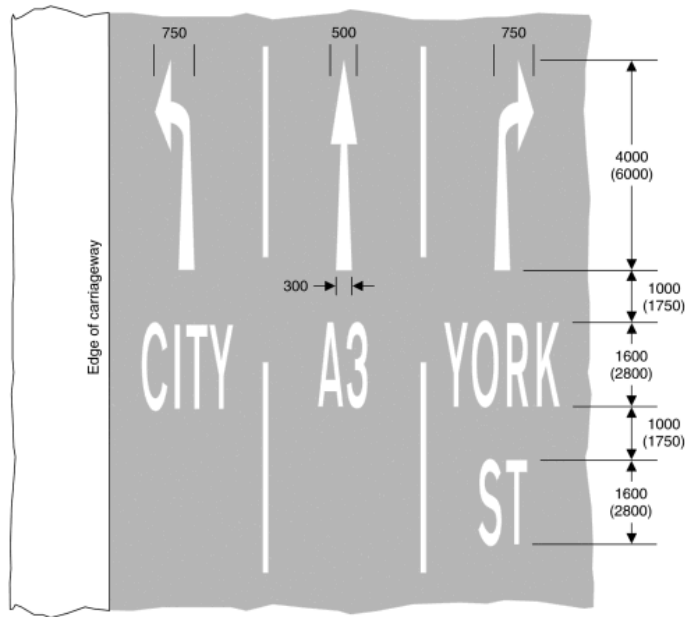

1035

Appropriate traffic lanes for different destinations

Item	
1	Regulations: 30(2), 31(5)
2	Directions: None
3	Diagrams: None
4	Permitted variants: Arrows may be omitted. The marking may be varied in accordance with regulation 30(2)
5	Illumination requirements: Schedule 17, item 12

**Status:** This is the original version (as it was originally made). This item of legislation is currently only available in its original format.

SCHEDULE 6 ROAD MARKINGS (contd.)

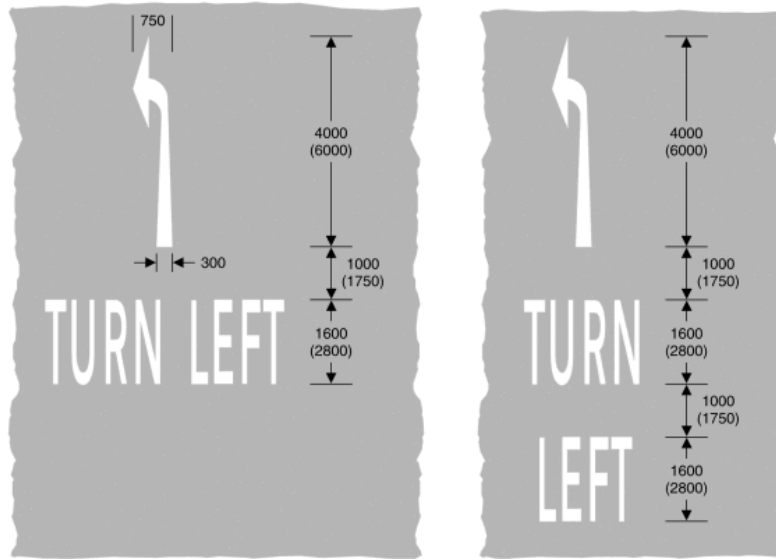

1036.1  
Vehicular traffic must turn left  
(Alternative types)

Item	
1	Regulations: 31
2	Directions: 7
3	Diagrams: None
4	Permitted variants: None
5	Illumination requirements: Schedule 17, item 12

**Status:** This is the original version (as it was originally made). This item of legislation is currently only available in its original format.

SCHEDULE 6 ROAD MARKINGS (contd.)

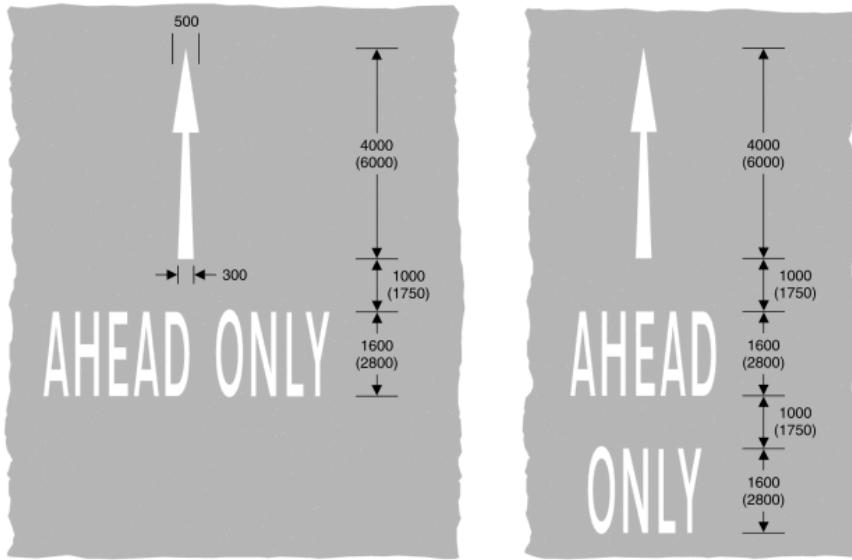

1036.2  
Vehicular traffic must only proceed ahead  
(Alternative types)

Item	
1	Regulations: 31
2	Directions: 7
3	Diagrams: None
4	Permitted variants: None
5	Illumination requirements: Schedule 17, Item 12

**Status:** This is the original version (as it was originally made). This item of legislation is currently only available in its original format.

SCHEDULE 6 ROAD MARKINGS (contd.)

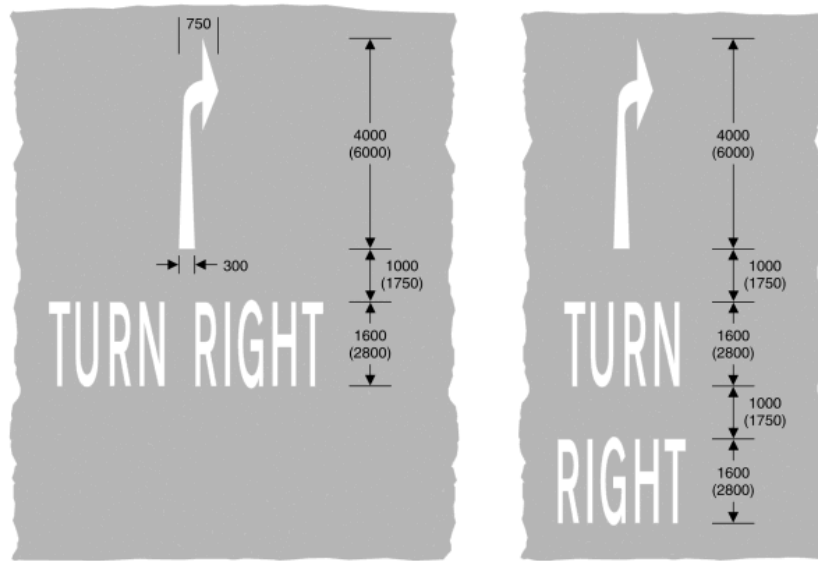

1037.1  
Vehicular traffic must turn right  
(Alternative types)

Item	
1	Regulations: 31
2	Directions: 7
3	Diagrams: None
4	Permitted variants: None
5	Illumination requirements: Schedule 17, item 12

**Status:** This is the original version (as it was originally made). This item of legislation is currently only available in its original format.

SCHEDULE 6 ROAD MARKINGS (contd.)

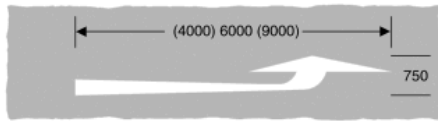

1038  
Appropriate traffic lanes for different manoeuvres  
(Longitudinal marking)

Item	
1	Regulations: None
2	Directions: None
3	Diagrams: None
4	Permitted variants: Direction of the arrow heads may be varied, but no arrow shall show more than two directions
5	Illumination requirements: Schedule 17, item 12

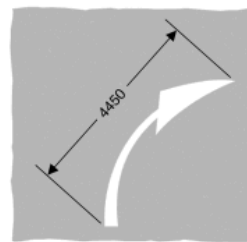
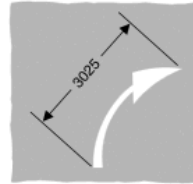

1038.1  
Appropriate direction to be taken  
by traffic turning within a junction  
(Alternative types)

Item	
1	Regulations: None
2	Directions: None
3	Diagrams: None
4	Permitted variants: The curvature of the arrow may be varied
5	Illumination requirements: Schedule 17, item 12

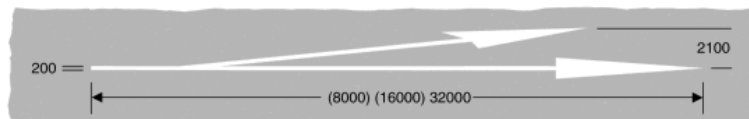

1039  
Place where traffic streams divide or bifurcate  
(Longitudinal marking)

Item	
1	Regulations: 31
2	Directions: None
3	Diagrams: None
4	Permitted variants: Schedule 16, item 28
5	Illumination requirements: Schedule 17, item 12



**Status:** This is the original version (as it was originally made). This item of legislation is currently only available in its original format.

SCHEDULE 6 ROAD MARKINGS (contd.)

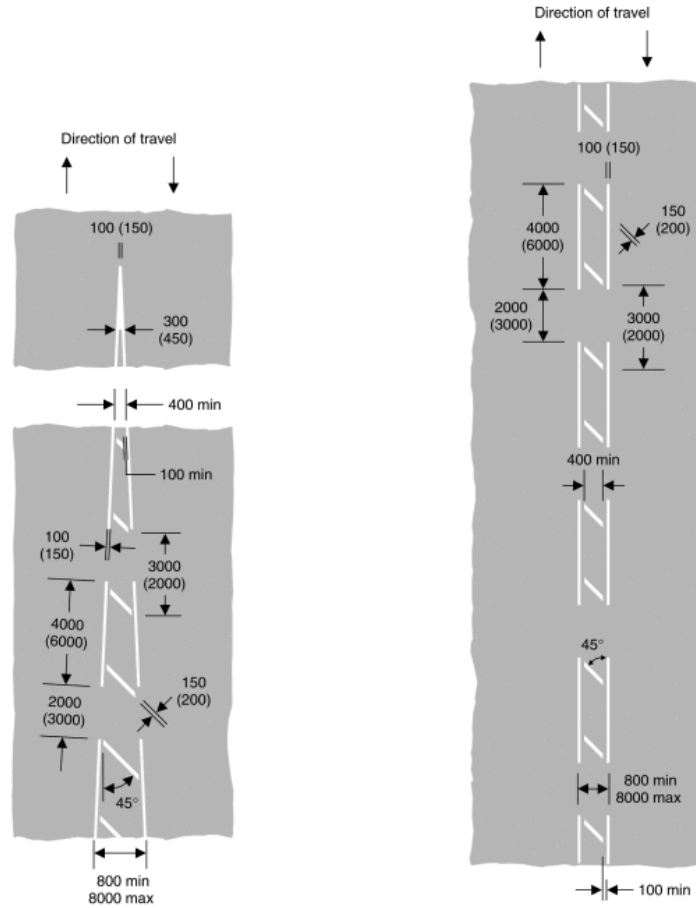

**1040**  
Part of the carriageway which vehicular traffic should not enter unless it is seen by the driver to be safe to do so

Item	
1	Regulations: 4, 12(4), 31
2	Directions: None
3	Diagrams: 1014
4	Permitted variants: One of the boundary lines shall be omitted when the marking is placed alongside diagram 1049 denoting a bus lane or cycle lane
5	Illumination requirements: Schedule 17, item 12

**1040.2**  
Length of road along which drivers should not overtake by passing through the marking unless it is seen by the driver to be safe to do so

Item	
1	Regulations: 4, 12(4), 31
2	Directions: None
3	Diagrams: None
4	Permitted variants: Same as diagram 1040
5	Illumination requirements: Schedule 17, item 12

**Status:** This is the original version (as it was originally made). This item of legislation is currently only available in its original format.

SCHEDULE 6 ROAD MARKINGS (contd.)

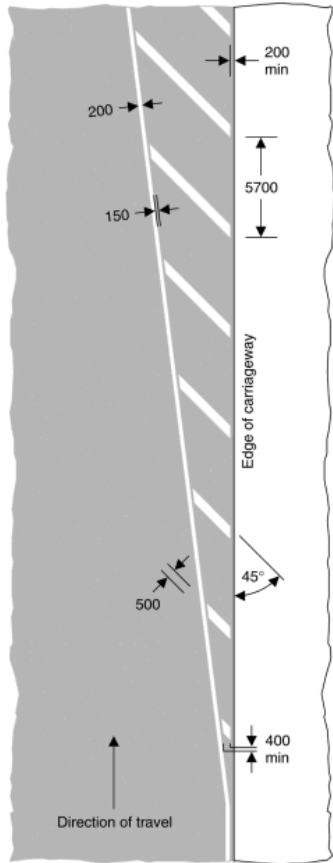

1040.3

Reduction in number of lanes, or area not available to traffic, on the main carriageway or slip road of a motorway or all-purpose dual carriageway road

Item	
1	Regulations: 31
2	Directions: None
3	Diagrams: 1014
4	Permitted variants: The width of the longitudinal line may be varied to 150 millimetres when used on an all-purpose road without hard shoulders. The boundary line may be replaced by the marking shown in diagram 1012.2 or 1012.3 as appropriate
5	Illumination requirements: Schedule 17, item 12

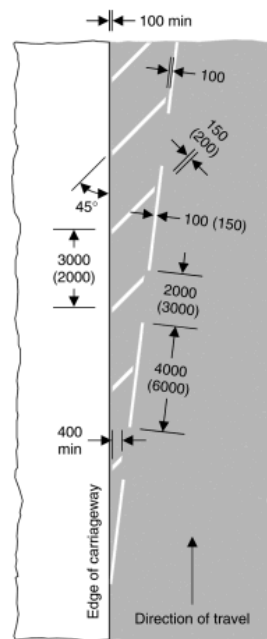

1040.4

Part of the carriageway adjacent to the edge which vehicular traffic should not enter unless it is seen by the driver to be safe to do so

Item	
1	Regulations: 12(4), 31
2	Directions: None
3	Diagrams: 1014
4	Permitted variants: The boundary to the left of the hatched area may be formed by the marking shown in diagram 1049 denoting the off side edge of a cycle lane. The angle of the hatching shall be reversed when the marking is used on the off side of the carriageway
5	Illumination requirements: Schedule 17, item 12

**Status:** This is the original version (as it was originally made). This item of legislation is currently only available in its original format.

SCHEDULE 6 ROAD MARKINGS (contd.)

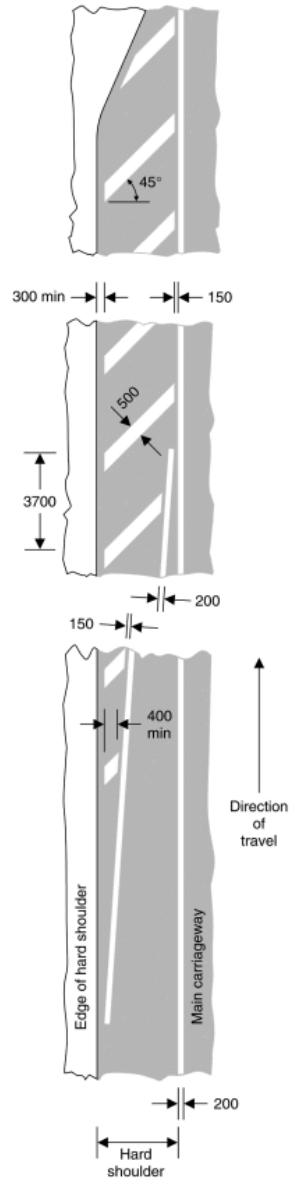

1040.5  
End of hard shoulder

Item	
1	Regulations: 31
2	Directions: None
3	Diagrams: None
4	Permitted variants: The boundary line and edge of carriageway line may be replaced by the marking shown in either diagram 1012.2 or diagram 1012.3 varied to 200 millimetres wide, as appropriate
5	Illumination requirements: Schedule 17, item 12

**Status:** This is the original version (as it was originally made). This item of legislation is currently only available in its original format.

SCHEDULE 6 ROAD MARKINGS (contd.)

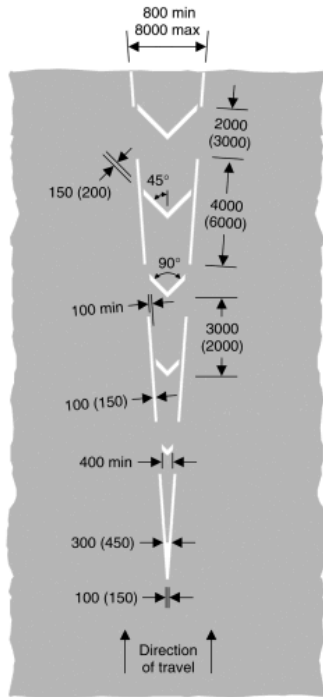

1041

Part of the carriageway where vehicular traffic passes in the same direction on both sides of the marking, and should not enter the area covered by the marking unless it is seen by the driver to be safe to do so

Item	
1	Regulations: 4, 12(4), 31
2	Directions: None
3	Diagrams: None
4	Permitted variants: The direction of the chevrons shall be reversed when the direction of travel is in the opposite direction. One of the boundary lines shall be omitted when the marking is placed alongside diagram 1049 denoting a bus lane or cycle lane
5	Illumination requirements: Schedule 17, item 12

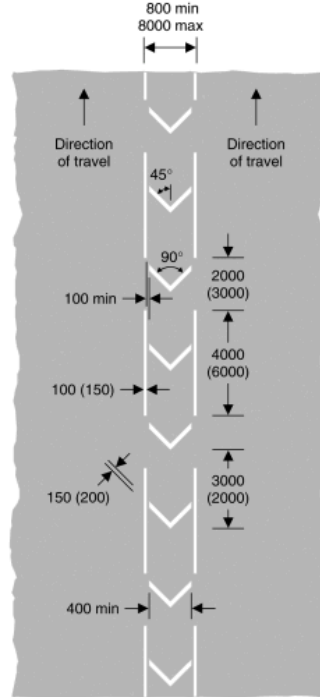

1041.1

Length of road along which vehicular traffic travels in the same direction on both sides of the marking, and should not enter the area covered by the marking unless it is seen by the driver to be safe to do so

Item	
1	Regulations: 4, 12(4), 31
2	Directions: None
3	Diagrams: None
4	Permitted variants: Same as diagram 1041
5	Illumination requirements: Schedule 17, item 12

**Status:** This is the original version (as it was originally made). This item of legislation is currently only available in its original format.

SCHEDULE 6 ROAD MARKINGS (contd.)

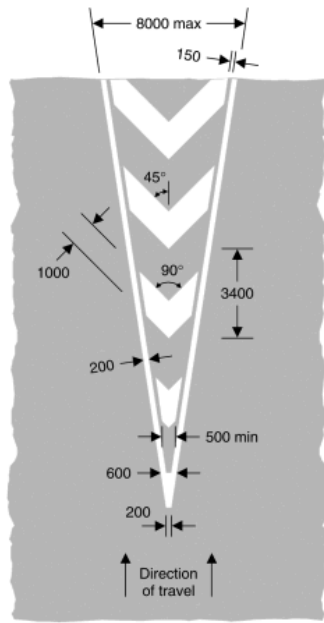

1042

Part of the verge or hard shoulder on a motorway or all-purpose dual carriageway road between the main carriageway of a motorway or all-purpose dual carriageway road and the carriageway of a slip road, or at the bifurcation or convergence of motorways or all-purpose dual carriageway roads, or part of a carriageway between two lanes at a roundabout which vehicular traffic must not enter except in an emergency

Item	
1	Regulations: 4, 10(1), 31
2	Directions: None
3	Diagrams: None
4	Permitted variants: The direction of the chevrons shall be reversed when the direction of travel is in the opposite direction. The width of the longitudinal lines may be varied to 150 millimetres when the marking is used between two lanes at a roundabout or on an all-purpose dual carriageway road without hard shoulders. Except at a roundabout, the boundary lines may be replaced by the marking shown in either diagram 1012.2 or diagram 1012.3 as appropriate
5	Illumination requirements: Schedule 17, item 12

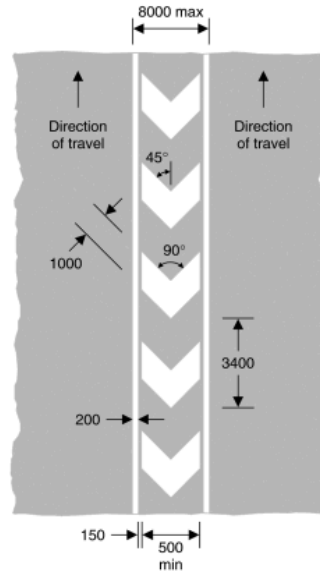

1042.1

Division of traffic lanes on a length of carriageway, or between the main carriageway and slip road, of a motorway or all-purpose dual carriageway road, or part of a carriageway between two lanes at a roundabout which vehicular traffic must not enter except in an emergency

Item	
1	Regulations: 4, 10(1), 31
2	Directions: None
3	Diagrams: None
4	Permitted variants: Same as diagram 1042
5	Illumination requirements: Schedule 17, item 12

**Status:** This is the original version (as it was originally made). This item of legislation is currently only available in its original format.

SCHEDULE 6 ROAD MARKINGS (contd.)

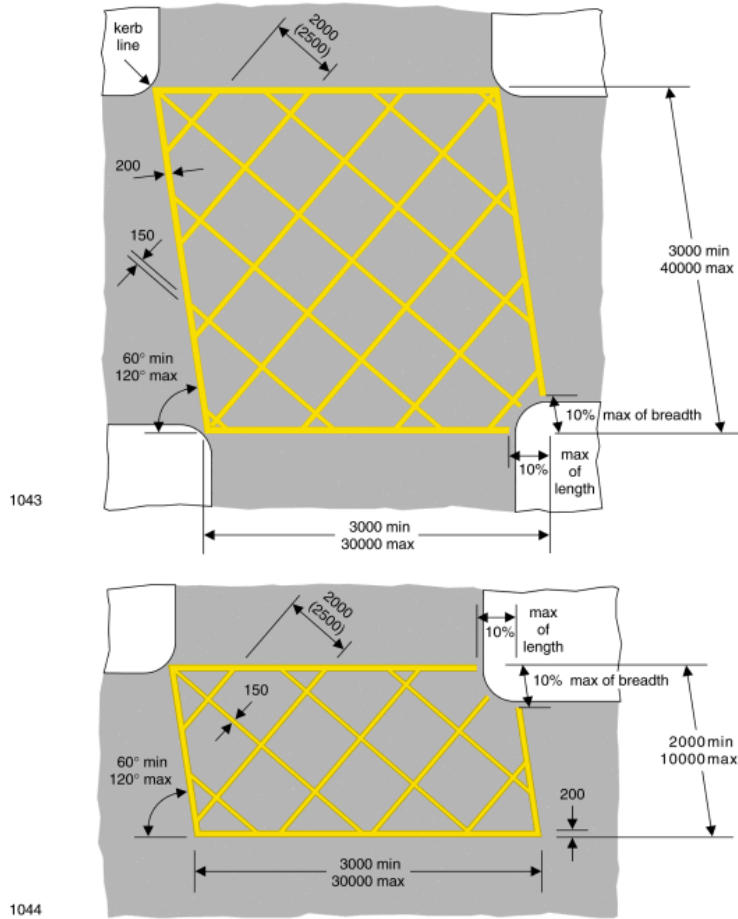

1043, 1044  
Marking conveying the requirements prescribed by regulation 29(2) and Part II of Schedule 19

Item	
1	Regulations: 10(1), 12(6), 12(11), 29(2)
2	Directions: 35
3	Diagrams: 615, 811
4	Permitted variants: Any corner may be cut away as shown. The cut-away corner may be completed in the same manner as the other corners. Parts of the marking shall be omitted where tram rails cross the marking. Parts of the marking may be omitted to indicate the edge of the path taken by a tramcar and, where so omitted, the remaining parts shall be bounded by a continuous yellow line
5	Illumination requirements: Schedule 17, item 12

**Status:** This is the original version (as it was originally made). This item of legislation is currently only available in its original format.

SCHEDULE 6 ROAD MARKINGS (contd.)

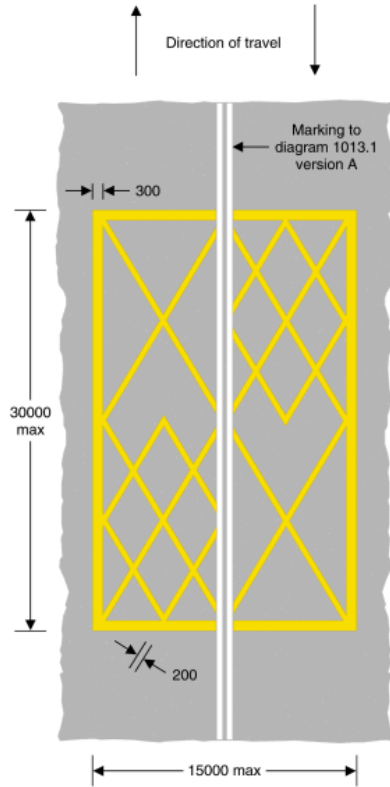

1045  
Area of carriageway at a level crossing which vehicles must not enter in a manner which then causes any part of the vehicle to remain at rest within the marked area due to the presence of stationary vehicles (Shown in combination with diagram 1013.1 version A)

Item	
1	Regulations: 10(1), 12(6)
2	Directions: 18(1)
3	Diagrams: 1013.1 (version A)
4	Permitted variants: The pattern of diagonal lines on each side of the level crossing may be extended longitudinally within the specified limit by increasing the number of diamond shapes on the approach side and the number of diagonal crosses on the leaving side
5	Illumination requirements: Schedule 17, item 12

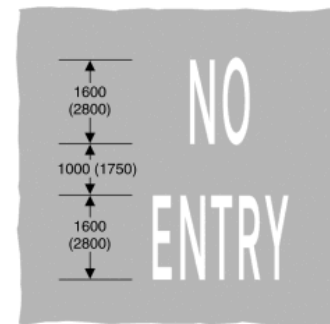

1046  
No entry for vehicular traffic (Alternative types)

Item	
1	Regulations: 31
2	Directions: 7
3	Diagrams: 616, and when the marking is varied to "PLAY STREET", 617 with 618
4	Permitted variants: "NO ENTRY" may be varied to "PLAY STREET"
5	Illumination requirements: Schedule 17, item 12

**Status:** This is the original version (as it was originally made). This item of legislation is currently only available in its original format.

SCHEDULE 6 ROAD MARKINGS (contd.)

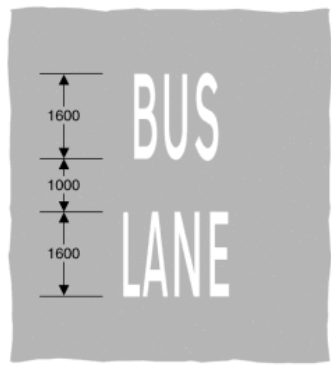

1048

With-flow lane reserved for buses and other vehicles as indicated on the sign shown in diagram 959 or a contra-flow lane reserved for buses

Item	
1	Regulations: 22, 23
2	Directions: 7, 17, 18(3)
3	Diagrams: 959, 960, 1049
4	Permitted variants: None
5	Illumination requirements: Schedule 17, item 12

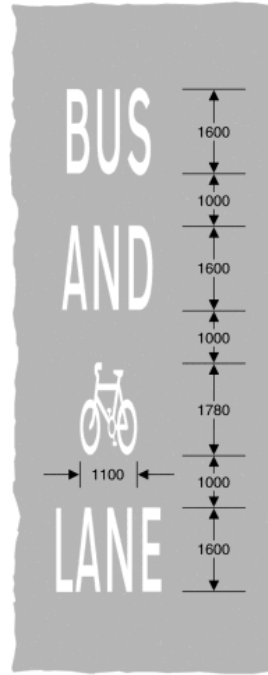

1048.1

Contra-flow lane reserved for buses and pedal cycles

Item	
1	Regulations: 22, 23
2	Directions: 7, 17, 18(3)
3	Diagrams: 960 (when varied to include the cycle symbol), 1049
4	Permitted variants: None
5	Illumination requirements: Schedule 17, item 12



**Status:** This is the original version (as it was originally made). This item of legislation is currently only available in its original format.

SCHEDULE 6 ROAD MARKINGS (contd.)

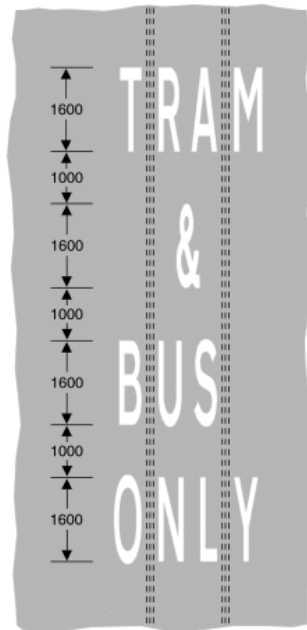

1048.2  
Road or part of a road with access permitted only for buses and trams

Item	
1	Regulations: 22
2	Directions: 7, 18(1)
3	Diagrams: 953.1
4	Permitted variants: "& BUS" may be omitted
5	Illumination requirements: Schedule 17, item 12

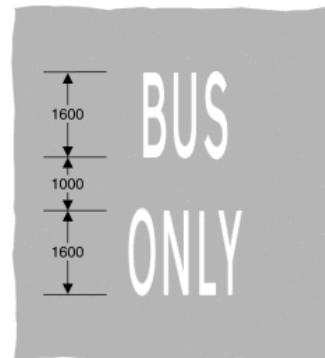

1048.3  
Road or part of a road with access permitted only for buses  
(Alternative types)

Item	
1	Regulations: 22
2	Directions: 7, 18(4)
3	Diagrams: 616 (when used with 954 or 954.2), 953 (when varied to show only the bus symbol)
4	Permitted variants: None
5	Illumination requirements: Schedule 17, item 12

**Status:** This is the original version (as it was originally made). This item of legislation is currently only available in its original format.

SCHEDULE 6 ROAD MARKINGS (contd.)

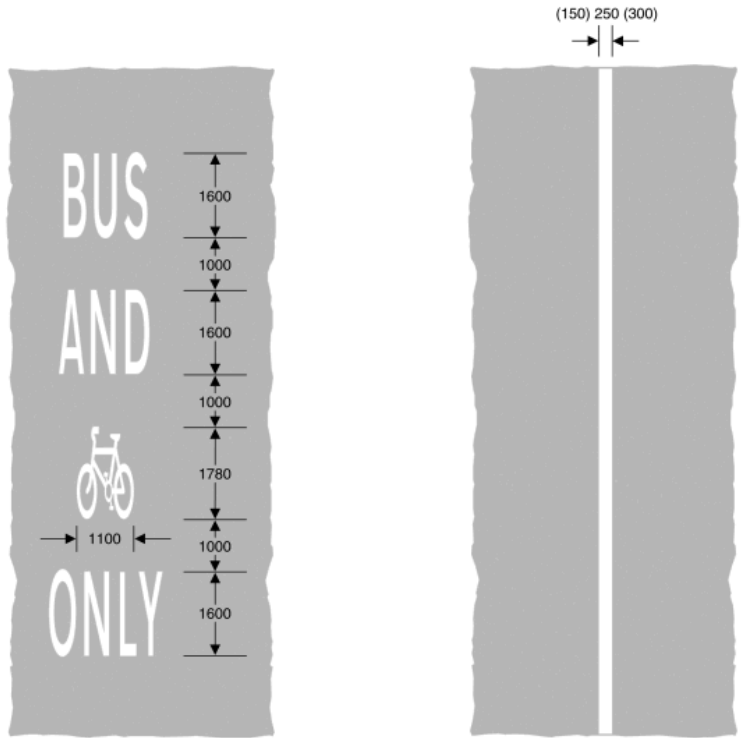

1048.4  
Road or part of a road with access permitted only for buses and pedal cycles

1049  
Boundary of a bus lane, cycle lane, cycle track or route used by pedal cycles and pedestrians only. Where used in conjunction with the sign shown in diagram 957, the division of a route into that part reserved for pedal cycles and that part reserved for pedestrians

Item	
1	Regulations: 22
2	Directions: 7, 18(1)
3	Diagrams: 953
4	Permitted variants: "AND" or the cycle symbol may be varied to "TAXI". The legend may be on two or three lines in which case "AND" may be varied to "&."
5	Illumination requirements: Schedule 17, item 12

Item	
1	Regulations: 4, 31
2	Directions: 7, 17, 18(3), 18(5), 33
3	Diagrams: 955, 956, 957, 959, 959.1, 960, 960.1, 1010, 1014, 1048, 1048.1, 1050, 1057, 1058
4	Permitted variants: None
5	Illumination requirements: Schedule 17, item 12

**Status:** This is the original version (as it was originally made). This item of legislation is currently only available in its original format.

SCHEDULE 6 ROAD MARKINGS (contd.)

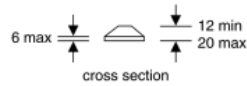
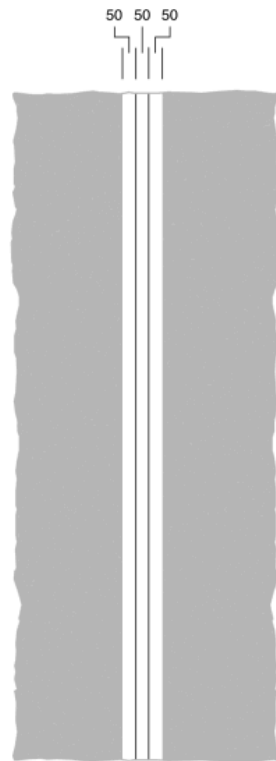

1049.1  
Division of a route into that part reserved for pedal cycles and that part reserved for pedestrians

Item	
1	Regulations: 11(2), 32(2)
2	Directions: 7, 18(3), 33
3	Diagrams: 957, 1057, 1058
4	Permitted variants: None
5	Illumination requirements: Schedule 17, item 12

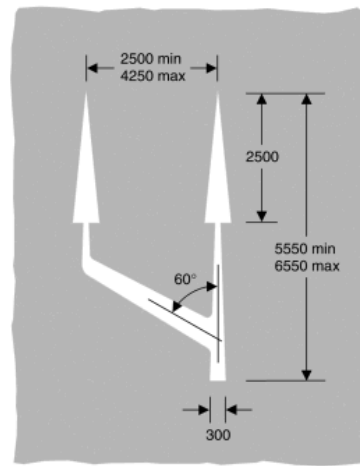

1050  
Direction of possible traffic movements at the end of a bus lane

Item	
1	Regulations: 12(6)
2	Directions: 7, 18(3)
3	Diagrams: 964, 1049
4	Permitted variants: The left hand arrow head may indicate a left turn in the manner shown in diagram 1036.1
5	Illumination requirements: Schedule 17, item 12

**Status:** This is the original version (as it was originally made). This item of legislation is currently only available in its original format.

SCHEDULE 6 ROAD MARKINGS (contd.)

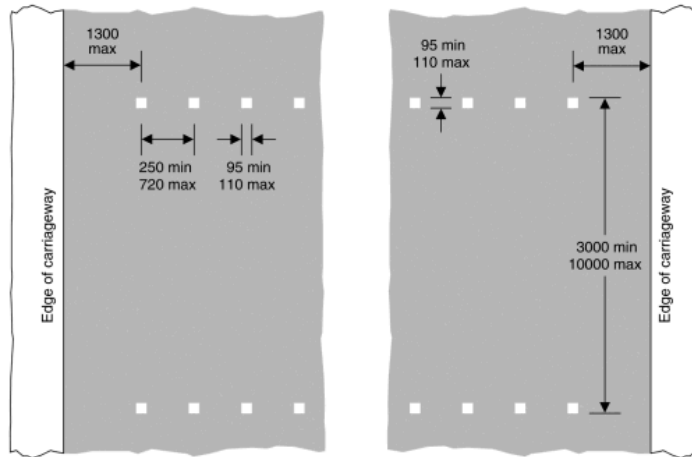

1055.1

- (a) Place suitable for pedestrians to cross a road at which traffic is subject to control by a constable in uniform or by a traffic warden, being control which is normally in operation during periods amounting in aggregate to not less than 20 hours in any week; or
- (b) the most suitable place for pedestrians to cross a carriageway within 10 metres of traffic light signals of the kind prescribed by regulation 33(1); or
- (c) place suitable for cyclists to cross a road at which cyclists are controlled by traffic light signals of the kind prescribed by regulation 33(2) and other vehicular traffic is controlled by traffic light signals of the kind prescribed by regulation 33(1); or
- (d) signal controlled pedestrian facility; or
- (e) Toucan crossing; or
- (f) equestrian only crossing

Item	
1	Regulations: 4, 11(4), 12(6)
2	Directions: 18(1)
3	Diagrams: 1001, 1001.3, 3000, 3000.2, 3000.7, 3000.8, 3000.9, 3000.10, 4002.1, 4003.1, 4003.2, 4003.4, 4003.5, 4003.7
4	Permitted variants: The square marks may be varied to circular marks with a diameter between 95 mm and 110 mm. The number of marks shall be varied according to the width of the road. The minimum width of a crossing, other than a Toucan crossing, may be reduced from 3000 mm to 2400 mm
5	Illumination requirements: Schedule 17, item 12

**Status:** This is the original version (as it was originally made). This item of legislation is currently only available in its original format.

SCHEDULE 6 ROAD MARKINGS (contd.)

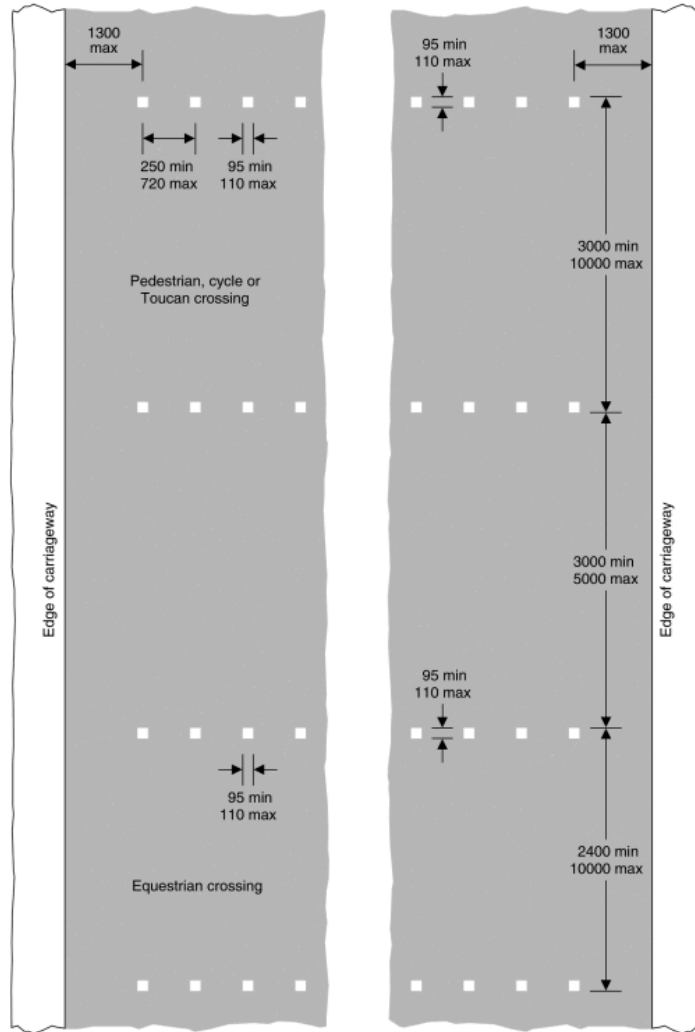

1055.2  
Same as diagram 1055.1 (c), (d) or (e) with an additional crossing point for equestrians

Item	
1	Regulations: 4, 11(4), 12(6)
2	Directions: 18(1)
3	Diagrams: 1001, 1001.3, 3000, 3000.2, 3000.7, 3000.8, 3000.9, 3000.10, 4002.1, 4003.1, 4003.2, 4003.4, 4003.5, 4003.7
4	Permitted variants: Same as diagram 1055.1
5	Illumination requirements: Schedule 17, item 12

**Status:** This is the original version (as it was originally made). This item of legislation is currently only available in its original format.

SCHEDULE 6 ROAD MARKINGS (contd.)

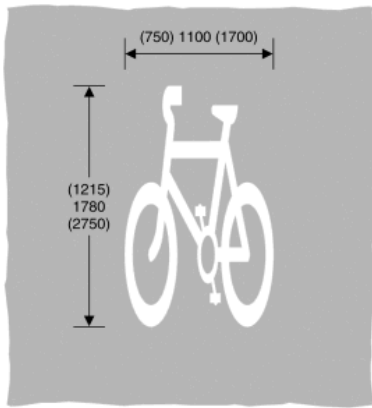

1057  
Cycle lane, track or route

Item	
1	Regulations: None
2	Directions: 17, 18(1), 18(3), 18(5)
3	Diagrams: 955, 956, 957, 959.1, 960.1, 965, 967, 1001.2, 1003, 1004, 1004.1, 1023, 1049, 1049.1, 1058, 1059, 2601.2, 2602.2
4	Permitted variants: Schedule 16, item 28
5	Illumination requirements: Schedule 17, item 12

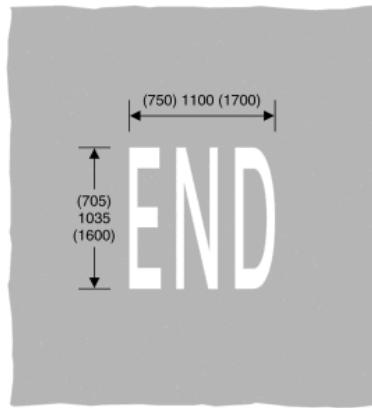

1058  
End of cycle lane, track or route

Item	
1	Regulations: None
2	Directions: 18(1)
3	Diagrams: 965, 1049, 1049.1, 1057
4	Permitted variants: None
5	Illumination requirements: Schedule 17, item 12

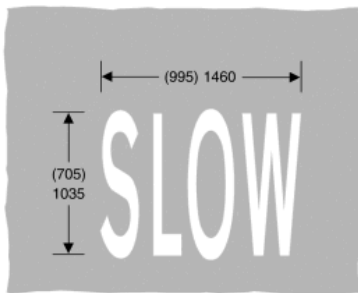

1058.1  
Pedal cycles should proceed with caution because of potential danger ahead

Item	
1	Regulations: None
2	Directions: None
3	Diagrams: None
4	Permitted variants: None
5	Illumination requirements: Schedule 17, item 12

**Status:** This is the original version (as it was originally made). This item of legislation is currently only available in its original format.

SCHEDULE 6 ROAD MARKINGS (contd.)

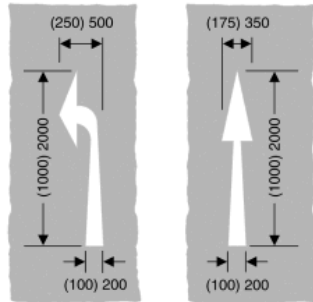

1059  
Directions in which pedal cycles should travel on a cycle lane, track or route

Item	
1	Regulations: None
2	Directions: 18(1)
3	Diagrams: 1057
4	Permitted variants: The arrow pointing to the left may be reversed to point to the right
5	Illumination requirements: Schedule 17, item 12

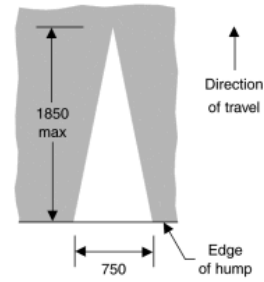

1062  
Road hump

Item	
1	Regulations: 27(1), 31
2	Directions: 17, 18(1)
3	Diagrams: 557.1, 1004, 1012.1, 1017, 1018.1
4	Permitted variants: None
5	Illumination requirements: Schedule 17, item 12

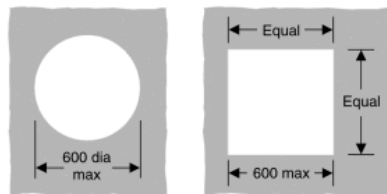

1063  
Limits of a measured length of road for assessing the speed of vehicular traffic (Alternative types)

Item	
1	Regulations: None
2	Directions: 39(4)
3	Diagrams: None
4	Permitted variants: None
5	Illumination requirements: Schedule 17, item 12

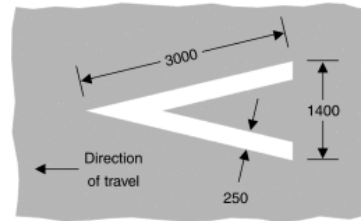

1064  
Chevron marking for use in conjunction with the sign shown in diagram 2933

Item	
1	Regulations: 31
2	Directions: 14(1), 17, 18(1), 18(7)
3	Diagrams: 2933, 2934
4	Permitted variants: None
5	Illumination requirements: Schedule 17, item 12

**Status:** This is the original version (as it was originally made). This item of legislation is currently only available in its original format.

SCHEDULE 6 ROAD MARKINGS (contd.)

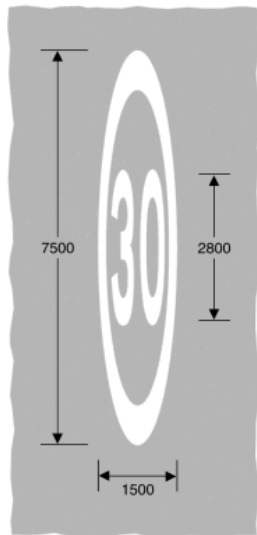
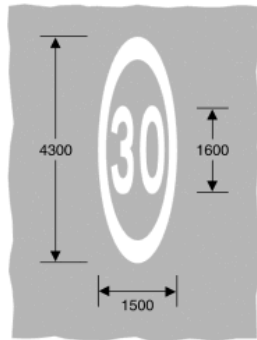

1065  
Maximum speed limit  
(Alternative sizes)

Item	
1	Regulations: 31
2	Directions: 7, 18(1)
3	Diagrams: 670, 674
4	Permitted variants: "30" may be varied to "20", "40" or "50", or, when used on a dual carriageway road only, to "60"
5	Illumination requirements: Schedule 17, item 12

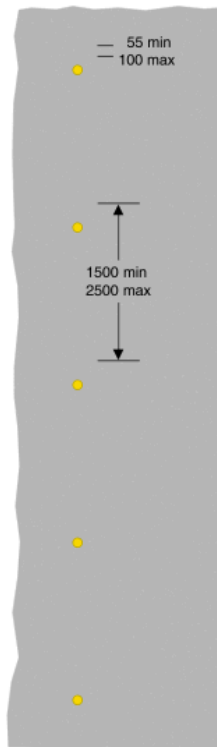

1066  
Edge of part of the road used by tramcars

Item	
1	Regulations: 12(6)
2	Directions: None
3	Diagrams: None
4	Permitted variants: None
5	Illumination requirements: Schedule 17, item 12



**Status:** This is the original version (as it was originally made). This item of legislation is currently only available in its original format.

## SCHEDULE 7

### DIRECTIONAL SIGNS

#### PART I

### PRIMARY ROUTE DIRECTIONAL SIGNS

SCHEDULE 7 PART I  
PRIMARY ROUTE DIRECTIONAL SIGNS

Regulation 11(1)



Item	
1	Regulations: None
2	Directions: 12(1)
3	Diagrams: None
4	Permitted variants: Schedule 16, items 3, 5, 16, 18, 19, 20, 21, 23, 24, 25, 26, 27, 30, 31, 32, 34, 35, 36, 37
5	Illumination requirements: Schedule 17, item 4

2001  
Junction ahead of two primary routes

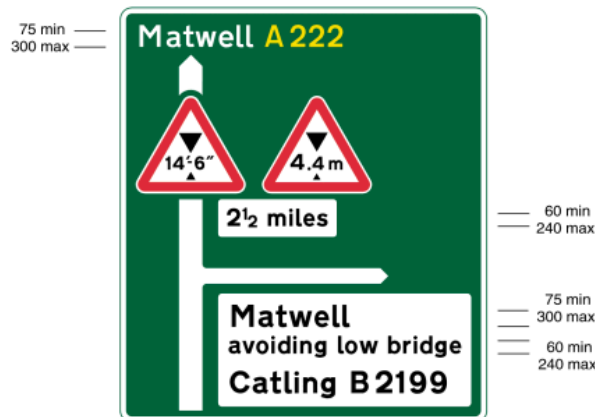

2002  
Junction ahead of a primary route with a non-primary route which is the recommended alternative route avoiding a low bridge on the primary route

Item	
1	Regulations: None
2	Directions: 12(1)
3	Diagrams: None
4	Permitted variants: Schedule 16, items 3, 5, 16, 18, 19, 20, 21, 23, 24, 25, 26, 27, 30, 31, 32, 34, 35, 36, 37
5	Illumination requirements: Schedule 17, item 4

*Status: This is the original version (as it was originally made). This item of legislation is currently only available in its original format.*

SCHEDULE 7 PART I PRIMARY ROUTE DIRECTIONAL SIGNS (contd.)

— 75 min	Item	
— 300 max	1	Regulations: None
— 60 min	2	Directions: 7, 12(1)
— 240 max	3	Diagrams: None
— 60 min	4	Permitted variants: Schedule 16, items 3, 5, 12, 16, 19, 20, 21, 23, 24, 25, 26, 27, 29, 30, 31, 32, 34, 35, 36, 37
— 75 min	5	Illumination requirements: Schedule 17, item 4
— 300 max		

2003  
Same as diagram 2002

— 75 min	
— 300 max	
— 75 min	
— 300 max	

2004  
Junction at named crossroads ahead between a primary route leading to a motorway and two non-primary routes, one of which also leads to a tourist attraction

Item	
1	Regulations: None
2	Directions: 12(1)
3	Diagrams: None
4	Permitted variants: Schedule 16, items 3, 5, 16, 18, 19, 20, 21, 23, 24, 25, 26, 27, 29, 30, 31, 32, 33, 34, 35, 37 Junction name and top panel may be omitted
5	Illumination requirements: Schedule 17, item 4

**Status:** This is the original version (as it was originally made). This item of legislation is currently only available in its original format.

SCHEDULE 7 PART I PRIMARY ROUTE DIRECTIONAL SIGNS (contd.)

Item	
1	Regulations: None
2	Directions: 12(1)
3	Diagrams: None
4	Permitted variants: Schedule 16, items 3, 5, 12, 16, 19, 20, 21, 23, 24, 25, 26, 27, 29, 30, 31, 32, 33, 34, 35, 37 Junction name and top panel may be omitted
5	Illumination requirements: Schedule 17, item 4

2005  
Same as diagram 2004

2005.1

Junction ahead of a primary route with a non-primary route which is an alternative numbered route for pedal cycles forming part of a cycle route network

Item	
1	Regulations: None
2	Directions: 12(1)
3	Diagrams: None
4	Permitted variants: Schedule 16, items 3, 5, 12, 16, 19, 20, 21, 23, 24, 25, 26, 27, 28, 29, 30, 31, 32, 34, 35, 36, 37 The name of the cycle route may be added in the manner shown in diagram 2602.1 but with the dimensions 60 min and 240 max substituted for the dimensions 24 min and 48 max shown in that diagram. The background colour of the cycle route number patch may be varied to blue
5	Illumination requirements: Schedule 17, item 4

**Status:** This is the original version (as it was originally made). This item of legislation is currently only available in its original format.

SCHEDULE 7 PART I PRIMARY ROUTE DIRECTIONAL SIGNS (contd.)



2006

Junction ahead with a non-primary route

Item	
1	Regulations: None
2	Directions: 12(1)
3	Diagrams: None
4	Permitted variants: Schedule 16, items 3, 5, 12, 19, 20, 23, 24, 25, 26, 27, 30, 31, 32, 34, 35
5	Illumination requirements: Schedule 17, item 4

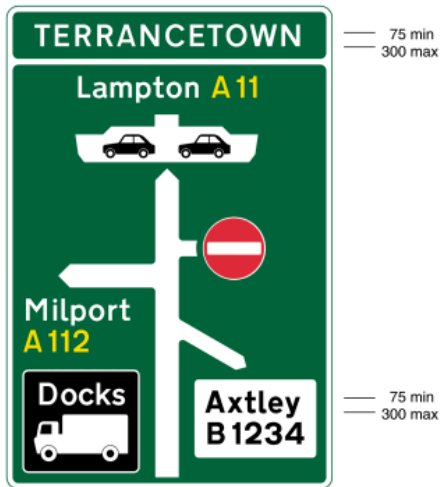

Item	
1	Regulations: None
2	Directions: 7, 12(1)
3	Diagrams: None
4	Permitted variants: Schedule 16, items 3, 5, 16, 18, 19, 20, 21, 23, 24, 25, 26, 27, 28, 30, 31, 32, 34, 35, 36 Location name and top panel may be omitted
5	Illumination requirements: Schedule 17, item 4

2007

Staggered junctions ahead between a primary route leading to a car ferry, a primary route which is the recommended route for goods vehicles to take to the docks, a non-primary route and a road to which entry is prohibited, in the village, town or suburb whose name is indicated at the top of the sign

**Status:** This is the original version (as it was originally made). This item of legislation is currently only available in its original format.

SCHEDULE 7 PART I PRIMARY ROUTE DIRECTIONAL SIGNS (contd.)

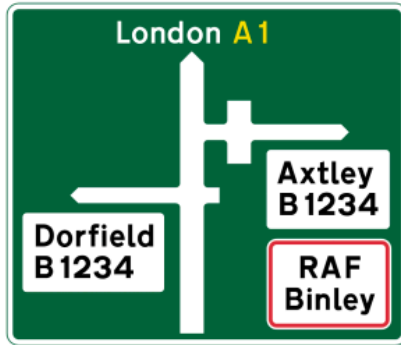

75 min  
300 max

Item	
1	Regulations: None
2	Directions: 12(1)
3	Diagrams: None
4	Permitted variants: Schedule 16, items 3, 5, 16, 18, 19, 20, 21, 23, 24, 25, 26, 27, 30, 31, 32, 34, 35, 36, 37
5	Illumination requirements: Schedule 17, item 4

2008

Staggered junction ahead at which a dual carriageway primary route is crossed by a non-primary route leading in one direction to a Ministry of Defence establishment



75 min  
300 max

60 min  
240 max

2009

Gyratory system ahead on a primary route which has junctions with a non-primary route and with another road along which there is a prohibition on vehicle entry at a specified distance from the junction

Item	
1	Regulations: None
2	Directions: 7, 12(1)
3	Diagrams: None
4	Permitted variants: Schedule 16, items 3, 5, 16, 18, 19, 20, 21, 23, 24, 25, 26, 27, 30, 31, 32, 34, 35, 36, 37
5	Illumination requirements: Schedule 17, item 4

**Status:** This is the original version (as it was originally made). This item of legislation is currently only available in its original format.

SCHEDULE 7 PART I PRIMARY ROUTE DIRECTIONAL SIGNS (contd.)

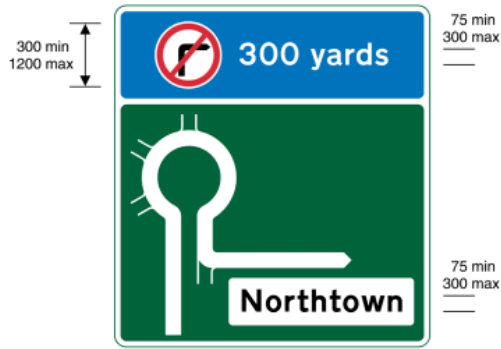

Item	
1	Regulations: None
2	Directions: 7, 12(1)
3	Diagrams: None
4	Permitted variants: Schedule 16, items 6, 16, 19, 20, 21, 23, 24, 25, 26, 27, 30, 34, 35 The diagram 612 symbol may be varied to a diagram 613 or 614 symbol
5	Illumination requirements: Schedule 17, item 4

2010.1  
Distance to a prohibited movement and direction to the destination shown, avoiding that prohibition



2010.2  
Direction to the destination shown avoiding a prohibited movement ahead

Item	
1	Regulations: None
2	Directions: 7, 12(1)
3	Diagrams: None
4	Permitted variants: Schedule 16, items 16, 19, 20, 21, 23, 24, 25, 26, 27, 30, 34, 35 The diagram 612 symbol may be varied to a diagram 613 symbol
5	Illumination requirements: Schedule 17, item 4

**Status:** This is the original version (as it was originally made). This item of legislation is currently only available in its original format.

SCHEDULE 7 PART I PRIMARY ROUTE DIRECTIONAL SIGNS (contd.)



2011  
Grade separated junction 1/2 mile ahead of a primary route with another primary route which leads to an airport and which forms part of an emergency diversion route

Item	
1	Regulations: None
2	Directions: 12(1)
3	Diagrams: None
4	Permitted variants: Schedule 16, items 7, 16, 19, 20, 21, 23, 24, 25, 26, 30, 31, 32, 34, 36
5	Illumination requirements: Schedule 17, item 4



2012  
Grade separated junction 1/2 mile ahead of a primary route with another primary route which leads to a motorway and with a non-primary route

Item	
1	Regulations: None
2	Directions: 12(1)
3	Diagrams: None
4	Permitted variants: Schedule 16, items 7, 16, 19, 20, 21, 23, 24, 25, 26, 30, 31, 32, 34, 36
5	Illumination requirements: Schedule 17, item 4

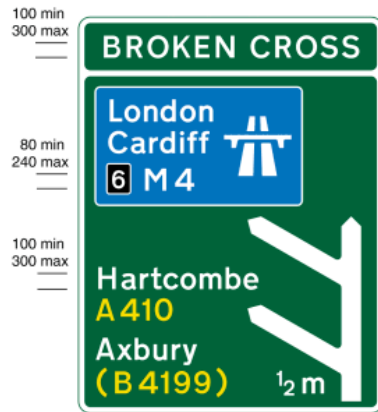

2013  
Two grade separated junctions in quick succession 1/2 mile ahead, one with a primary route which leads to a non-primary route and the other with a motorway at the junction whose name is indicated at the top of the sign

Item	
1	Regulations: None
2	Directions: 12(1)
3	Diagrams: None
4	Permitted variants: Schedule 16, items 7, 16, 19, 20, 21, 23, 24, 25, 26, 30, 31, 32, 34 Junction name and top panel may be omitted. The distance in miles to the second exit may be shown in a manner similar to the distance shown to the first exit
5	Illumination requirements: Schedule 17, item 4

**Status:** This is the original version (as it was originally made). This item of legislation is currently only available in its original format.

SCHEDULE 7 PART I PRIMARY ROUTE DIRECTIONAL SIGNS (contd.)



2014  
Grade separated junction of a primary route with a non-primary route

Item	
1	Regulations: None
2	Directions: 12(1)
3	Diagrams: None
4	Permitted variants: Schedule 16, items 7, 16, 19, 20, 21, 23, 24, 25, 26, 30, 31, 32, 34, 36
5	Illumination requirements: Schedule 17, item 4

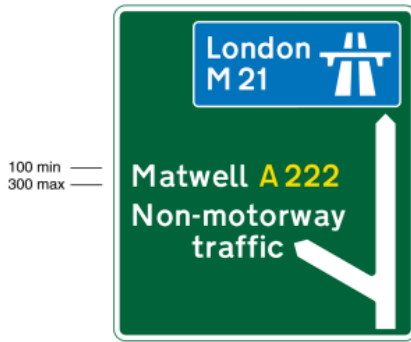

2015  
Grade separated junction of a primary route, which leads directly onto a motorway, with another primary route which should be followed by traffic not wishing or permitted to use the motorway

Item	
1	Regulations: None
2	Directions: 12(1)
3	Diagrams: None
4	Permitted variants: Schedule 16, items 7, 16, 19, 20, 21, 23, 24, 25, 26, 30, 31, 32, 34, 36
5	Illumination requirements: Schedule 17, item 4



2016  
Same as diagram 2015

Item	
1	Regulations: None
2	Directions: 12(1)
3	Diagrams: None
4	Permitted variants: Schedule 16, items 12, 19, 20, 21, 23, 24, 25, 26, 30, 31, 32, 34, 35, 36 The upper directional sign panel may be omitted
5	Illumination requirements: Schedule 17, item 4



**Status:** This is the original version (as it was originally made). This item of legislation is currently only available in its original format.

SCHEDULE 7 PART I PRIMARY ROUTE DIRECTIONAL SIGNS (contd.)



2017  
Grade separated junction 1/2 mile ahead where the left hand lane of a primary route leaves the main carriageway of that route and leads to another primary route

Item	
1	Regulations: None
2	Directions: 12(1)
3	Diagrams: None
4	Permitted variants: Schedule 16, items 7, 16, 19, 20, 21, 23, 24, 25, 26, 30, 31, 32, 34, 35, 36
5	Illumination requirements: Schedule 17, item 4



2018  
Grade separated junction where the left hand lane of a primary route leaves the main carriageway of that route and leads to a non-primary route

Item	
1	Regulations: None
2	Directions: 12(1)
3	Diagrams: None
4	Permitted variants: Schedule 16, items 16, 19, 20, 21, 23, 24, 25, 26, 30, 31, 32, 34, 35
5	Illumination requirements: Schedule 17, item 4

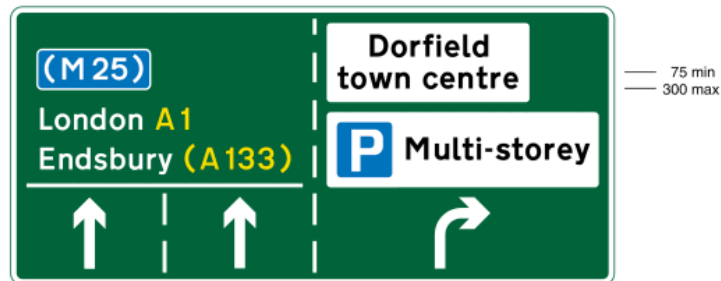

2019  
Junction where one lane of a primary route is reserved for traffic turning onto a non-primary route; the primary route leads to a motorway

Item	
1	Regulations: None
2	Directions: 12(1)
3	Diagrams: None
4	Permitted variants: Schedule 16, items 12, 16, 19, 20, 21, 23, 24, 25, 26, 27, 30, 31, 32, 34, 35, 36, 37 The chevron marking shown in diagram 2018 may be added and varied as appropriate
5	Illumination requirements: Schedule 17, item 4

**Status:** This is the original version (as it was originally made). This item of legislation is currently only available in its original format.

SCHEDULE 7 PART I PRIMARY ROUTE DIRECTIONAL SIGNS (contd.)



2020  
Grade separated junction ahead of a primary route, which leads to one carriageway of a motorway, with another primary route, which leads to the other carriageway of the motorway, and with a non-primary route; the number of lanes on the main carriageway remains the same through the junction (Gantry-mounted sign)

Item	
1	Regulations: None
2	Directions: 12(1)
3	Diagrams: None
4	Permitted variants: Schedule 16, items 7, 9, 12, 19, 20, 21, 23, 30, 34, 36
5	Illumination requirements: Schedule 17, item 4

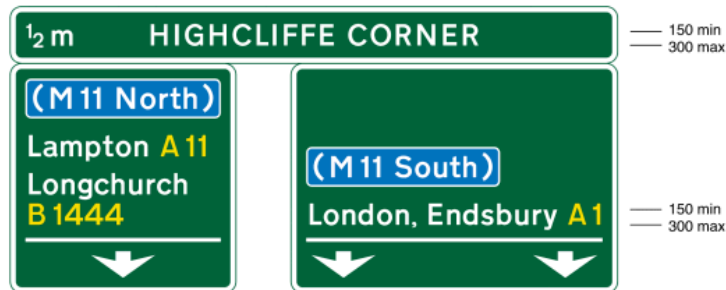

2021  
Named grade separated junction ahead on a primary route, or directions at a grade separated junction when distance and junction name omitted, where the left hand lane leads to a primary route, to one carriageway of a motorway and to a non-primary route, and the two right hand lanes continue on the main primary route and also lead to the other carriageway of the motorway (Gantry-mounted sign)

Item	
1	Regulations: None
2	Directions: 12(1)
3	Diagrams: None
4	Permitted variants: Schedule 16, items 7, 9, 16, 19, 20, 21, 23, 30, 34 Junction name and top panel may be omitted. The distance to the junction may be shown in a green panel positioned at the bottom of and to the left of the sign assembly
5	Illumination requirements: Schedule 17, item 4

**Status:** This is the original version (as it was originally made). This item of legislation is currently only available in its original format.

SCHEDULE 7 PART I PRIMARY ROUTE DIRECTIONAL SIGNS (contd.)



2021.1

Appropriate traffic lanes on a primary route at a junction or on the approach to a junction leading to the destinations shown; the right hand lane leads to a non-primary route (Gantry-mounted sign)

Item	
1	Regulations: None
2	Directions: 12(1)
3	Diagrams: None
4	Permitted variants: Schedule 16, items 16, 19, 20, 21, 23, 30, 34
5	Illumination requirements: Schedule 17, item 4



2022

Roundabout ahead at the junction of two primary routes

Item	
1	Regulations: None
2	Directions: 12(1)
3	Diagrams: None
4	Permitted variants: Schedule 16, items 3, 5, 16, 18, 19, 20, 21, 23, 24, 25, 26, 27, 30, 31, 32, 34, 35, 36, 37
5	Illumination requirements: Schedule 17, item 4

**Status:** This is the original version (as it was originally made). This item of legislation is currently only available in its original format.

SCHEDULE 7 PART I PRIMARY ROUTE DIRECTIONAL SIGNS (contd.)

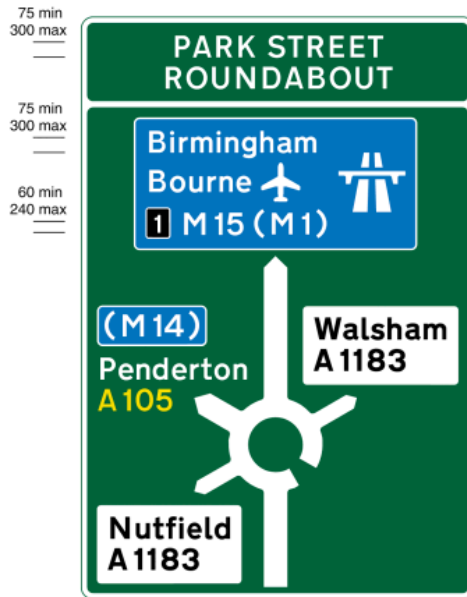

2023

Named roundabout ahead on a primary route with exits to a non-primary route in two directions, a primary route which leads to a motorway, and a motorway which leads to another motorway and an airport

Item	
1	Regulations: None
2	Directions: 12(1)
3	Diagrams: None
4	Permitted variants: Schedule 16, items 3, 5, 16, 18, 19, 20, 21, 23, 24, 25, 26, 27, 30, 31, 32, 34, 35, 37 Junction name and top panel may be omitted
5	Illumination requirements: Schedule 17, item 4

**Status:** This is the original version (as it was originally made). This item of legislation is currently only available in its original format.

SCHEDULE 7 PART I PRIMARY ROUTE DIRECTIONAL SIGNS (contd.)

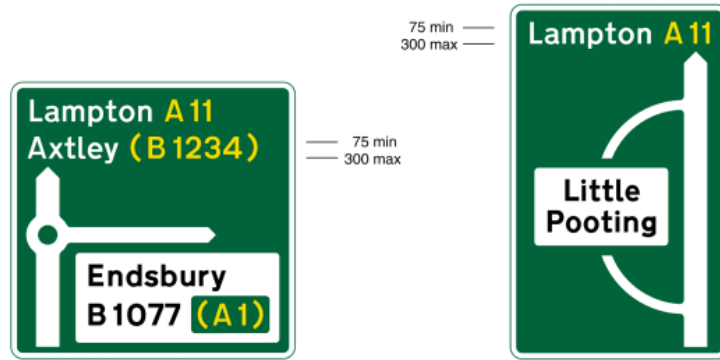

2024  
Mini-roundabout ahead with exits to a primary route, leading to a non-primary route, and a non-primary route, leading to another primary route

Item	
1	Regulations: None
2	Directions: 12(1)
3	Diagrams: None
4	Permitted variants: Schedule 16, items 3, 5, 16, 18, 19, 20, 21, 23, 24, 25, 26, 27, 30, 31, 32, 34, 35, 36, 37
5	Illumination requirements: Schedule 17, item 4

2025  
Junction ahead of a primary route with a non-primary route through a town or village that has been by-passed

Item	
1	Regulations: None
2	Directions: 12(1)
3	Diagrams: None
4	Permitted variants: Schedule 16, items 3, 5, 16, 18, 19, 20, 21, 23, 24, 30, 31, 32, 34, 35, 36
5	Illumination requirements: Schedule 17, item 4



2026  
Direction to a primary route which leads to a motorway and a non-primary route

Item	
1	Regulations: None
2	Directions: 12(2)
3	Diagrams: None
4	Permitted variants: Schedule 16, items 3, 5, 15, 19, 20, 21, 24, 30, 31, 32, 34
5	Illumination requirements: Schedule 17, item 4

**Status:** This is the original version (as it was originally made). This item of legislation is currently only available in its original format.

SCHEDULE 7 PART I PRIMARY ROUTE DIRECTIONAL SIGNS (contd.)



2027  
Direction to a primary route along which there is a low bridge

Item	
1	Regulations: None
2	Directions: 12(2)
3	Diagrams: None
4	Permitted variants: Schedule 16, items 3, 5, 15, 19, 20, 21, 24, 29, 30, 31, 32, 34
5	Illumination requirements: Schedule 17, item 4



2027.1  
Direction to a primary route which leads to the destination shown, to a railway station and to a recycling centre

Item	
1	Regulations: None
2	Directions: 12(2)
3	Diagrams: None
4	Permitted variants: Schedule 16, items 3, 5, 15, 19, 20, 21, 24, 29, 30, 31, 32, 34 "Recycling centre" may be varied to another appropriate description
5	Illumination requirements: Schedule 17, item 4



2028  
Direction to a primary route

Item	
1	Regulations: None
2	Directions: 12(2)
3	Diagrams: None
4	Permitted variants: Schedule 16, items 3, 5, 12, 19, 20, 21, 24, 25, 26, 30, 31, 32, 34, 35
5	Illumination requirements: Schedule 17, item 4



2029  
Directions to a primary route and a non-primary route

Item	
1	Regulations: None
2	Directions: 12(2)
3	Diagrams: None
4	Permitted variants: Schedule 16, items 3, 5, 12, 19, 20, 21, 23, 24, 25, 26, 30, 31, 32, 34, 35
5	Illumination requirements: Schedule 17, item 4

**Status:** This is the original version (as it was originally made). This item of legislation is currently only available in its original format.

SCHEDULE 7 PART I PRIMARY ROUTE DIRECTIONAL SIGNS (contd.)



2030  
The number of a primary route with distances to destinations along or reached from that route

Item	
1	Regulations: None
2	Directions: 12(1)
3	Diagrams: None
4	Permitted variants: Schedule 16, items 5, 19, 20, 21, 30
5	Illumination requirements: Schedule 17, item 4



2030.1  
Same as diagram 2030 but with the number of another primary route reached from that route and leading to a named destination

Item	
1	Regulations: None
2	Directions: 12(1)
3	Diagrams: None
4	Permitted variants: Schedule 16, items 5, 19, 20, 21, 30
5	Illumination requirements: Schedule 17, item 4



2031  
The number of a primary route

Item	
1	Regulations: None
2	Directions: 13(3)
3	Diagrams: None
4	Permitted variants: Schedule 16, items 20, 21
5	Illumination requirements: Schedule 17, item 4



2032  
Primary route forming part of a ring road

Item	
1	Regulations: None
2	Directions: 12(1)
3	Diagrams: None
4	Permitted variants: None
5	Illumination requirements: Schedule 17, item 4

**Status:** This is the original version (as it was originally made). This item of legislation is currently only available in its original format.

SCHEDULE 7 PART I PRIMARY ROUTE DIRECTIONAL SIGNS (contd.)



2033  
Crossroads ahead between a primary route and a ring road which is a non-primary route

Item	
1	Regulations: None
2	Directions: 12(1)
3	Diagrams: None
4	Permitted variants: Schedule 16, items 3, 5, 16, 18, 19, 20, 21, 23, 24, 25, 26, 27, 30, 31, 32, 34, 35, 36, 37
5	Illumination requirements: Schedule 17, item 4



75 min  
300 max

75 min  
300 max



2034  
Route to be followed at junction ahead for destinations that are not otherwise shown on signs for that junction

Item	
1	Regulations: None
2	Directions: 12(1)
3	Diagrams: None
4	Permitted variants: Schedule 16, items 19, 20, 21, 30, 34 "follow" and the route may be varied to "leave at next junction", or "leave at" and the name of a junction. The legend "Park and Ride" may be added after "Kingsford", or "follow" and the route may be varied to "use" and the Park and Ride symbol shown in diagram 2503, or its permitted variants, with a white border added
5	Illumination requirements: Schedule 17, item 4

2035  
Direction along a primary route to destinations shown via a U-turn at a roundabout ahead

Item	
1	Regulations: None
2	Directions: 12(1)
3	Diagrams: None
4	Permitted variants: Schedule 16, items 3, 5, 19, 20, 21, 23, 24, 25, 26, 27, 30, 31, 32, 34, 35
5	Illumination requirements: Schedule 17, item 4



**Status:** This is the original version (as it was originally made). This item of legislation is currently only available in its original format.

## PART II

### NON-PRIMARY ROUTE DIRECTIONAL SIGNS

#### SCHEDULE 7 PART II NON-PRIMARY ROUTE DIRECTIONAL SIGNS

Regulation 11(1)

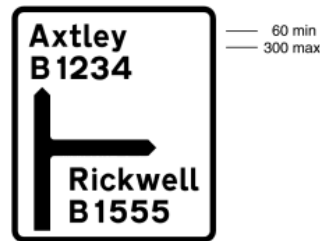

2101  
Junction ahead of two non-primary routes

Item	
1	Regulations: None
2	Directions: 13(1)
3	Diagrams: None
4	Permitted variants: Schedule 16, items 3, 5, 16, 18, 19, 20, 21, 22, 24, 25, 26, 27, 30, 31, 32, 34, 35, 36, 37
5	Illumination requirements: Schedule 17, item 4



2101.1  
Grade separated junction ahead of a non-primary route and a primary route

Item	
1	Regulations: None
2	Directions: 13(1)
3	Diagrams: None
4	Permitted variants: Schedule 16, items 7, 16, 19, 20, 21, 22, 24, 25, 26, 30, 31, 32, 34, 36
5	Illumination requirements: Schedule 17, item 4



2101.2  
Grade separated junction of a non-primary route leading to a motorway with another non-primary route leading to a primary route

Item	
1	Regulations: None
2	Directions: 13(1)
3	Diagrams: None
4	Permitted variants: Schedule 16, items 7, 16, 19, 20, 21, 22, 24, 25, 26, 30, 31, 32, 34, 36
5	Illumination requirements: Schedule 17, item 4

*Status: This is the original version (as it was originally made). This item of legislation is currently only available in its original format.*

SCHEDULE 7 PART II NON-PRIMARY ROUTE DIRECTIONAL SIGNS (contd.)

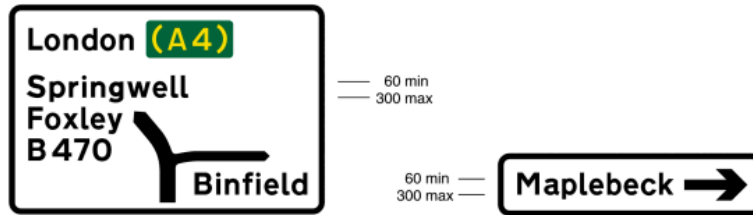

2102  
Junction ahead of two non-primary routes, one of which leads to a primary route

Item	
1	Regulations: None
2	Directions: 13(1)
3	Diagrams: None
4	Permitted variants: Schedule 16, items 3, 5, 16, 18, 19, 20, 21, 22, 24, 25, 26, 27, 30, 31, 32, 34, 35, 36, 37
5	Illumination requirements: Schedule 17, item 4

2102.1  
Junction ahead of a non-primary route with another non-primary route

Item	
1	Regulations: None
2	Directions: 13(1)
3	Diagrams: None
4	Permitted variants: Schedule 16, items 3, 5, 12, 19, 20, 24, 25, 26, 27, 30, 31, 32, 34, 35
5	Illumination requirements: Schedule 17, item 4

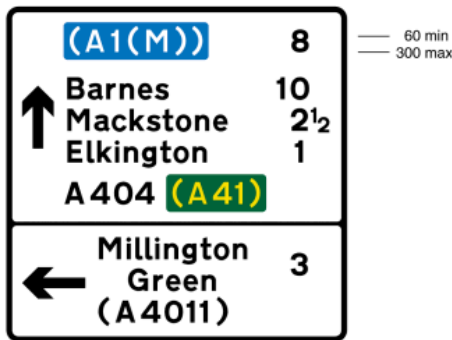

2103  
Junction ahead of two non-primary routes, one of which leads to a primary route and a motorway

Item	
1	Regulations: None
2	Directions: 13(1)
3	Diagrams: None
4	Permitted variants: Schedule 16, items 5, 9, 12, 16, 19, 20, 21, 22, 24, 25, 26, 27, 30, 31, 32, 34, 35, 36, 37
5	Illumination requirements: Schedule 17, item 4

**Status:** This is the original version (as it was originally made). This item of legislation is currently only available in its original format.

SCHEDULE 7 PART II NON-PRIMARY ROUTE DIRECTIONAL SIGNS (contd.)

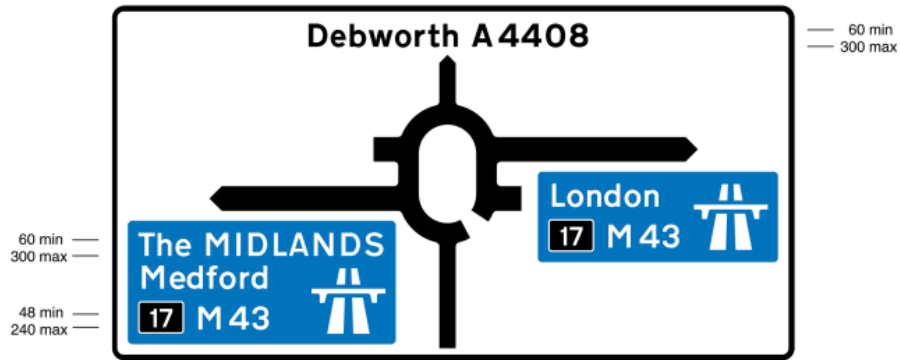

2104  
Junction ahead of a non-primary route with a motorway at the junction whose number is specified

Item	
1	Regulations: None
2	Directions: 13(1)
3	Diagrams: None
4	Permitted variants: Schedule 16, items 3, 5, 16, 18, 19, 20, 21, 22, 24, 25, 26, 27, 30, 31, 32, 34, 35, 36, 37
5	Illumination requirements: Schedule 17, item 4

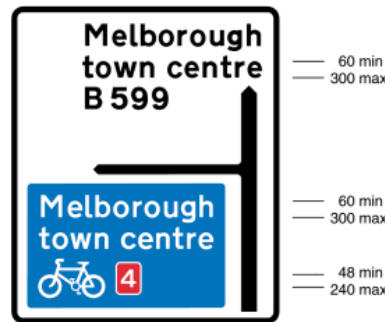

2105.1  
Junction ahead of a non-primary route with an alternative numbered route for pedal cycles forming part of a national cycle route network

Item	
1	Regulations: None
2	Directions: 13(1)
3	Diagrams: None
4	Permitted variants: Schedule 16, items 3, 5, 16, 18, 19, 20, 21, 22, 24, 25, 26, 27, 28, 29, 30, 31, 32, 34, 35, 36, 37 The name of the cycle route may be added in the manner shown in diagram 2602.1 but with the dimensions 48 min and 240 max substituted for the dimensions 24 min and 48 max shown in that diagram. The background colour of the route number patch shall be varied to blue when the route forms part of a regional cycle route network
5	Illumination requirements: Schedule 17, item 4

*Status: This is the original version (as it was originally made). This item of legislation is currently only available in its original format.*

SCHEDULE 7 PART II NON-PRIMARY ROUTE DIRECTIONAL SIGNS (contd.)

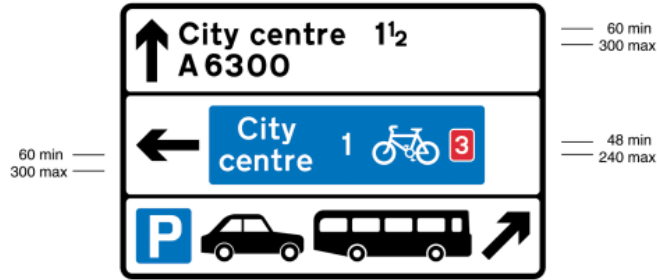

2106.1

Junction ahead of a non-primary route with an alternative numbered route for pedal cycles forming part of a national cycle route network and a route leading to parking for cars and buses

Item	
1	Regulations: 24(1)
2	Directions: 13(1)
3	Diagrams: None
4	Permitted variants: Schedule 16, items 5, 9, 12, 16, 19, 20, 21, 22, 24, 25, 26, 27, 28, 29, 30, 31, 32, 34, 35, 36, 37 Same as diagram 2105.1. The relative position of the cycle symbol and the associated distance shall be reversed when the cycle route number patch is omitted
5	Illumination requirements: Schedule 17, item 4

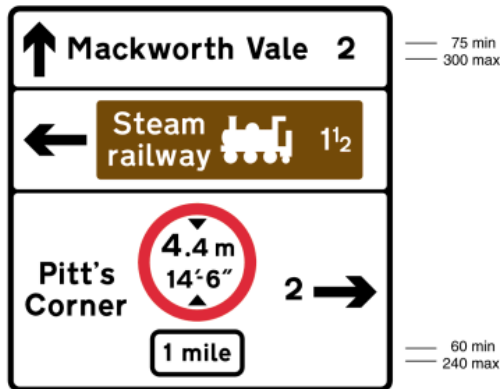

2107

Junction ahead of a non-primary route with a route leading to a tourist attraction and another non-primary route on which there is a height restriction

Item	
1	Regulations: None
2	Directions: 7, 13(1)
3	Diagrams: None
4	Permitted variants: Schedule 16, items 5, 9, 12, 16, 19, 20, 21, 22, 24, 25, 26, 27, 29, 30, 31, 32, 33, 34, 35, 36, 37
5	Illumination requirements: Schedule 17, item 4

**Status:** This is the original version (as it was originally made). This item of legislation is currently only available in its original format.

SCHEDULE 7 PART II NON-PRIMARY ROUTE DIRECTIONAL SIGNS (contd.)

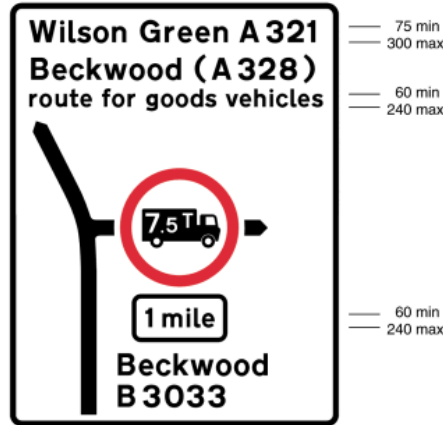

Item	
1	Regulations: None
2	Directions: 7, 13(1)
3	Diagrams: None
4	Permitted variants: Schedule 16, items 3, 5, 16, 18, 19, 20, 21, 22, 24, 25, 26, 27, 28, 30, 31, 32, 34, 35, 36, 37
5	Illumination requirements: Schedule 17, item 4

2108

Junction ahead of two non-primary routes, on one of which there is a weight restriction, and the other is the alternative route to avoid the weight restriction

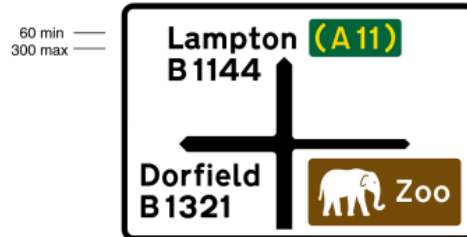

2109

Junction ahead of two non-primary routes, one of which leads to a primary route, and a route leading to a tourist attraction

Item	
1	Regulations: None
2	Directions: 13(1)
3	Diagrams: None
4	Permitted variants: Schedule 16, items 3, 5, 16, 18, 19, 20, 21, 22, 24, 25, 26, 27, 29, 30, 31, 32, 33, 34, 35, 36, 37
5	Illumination requirements: Schedule 17, item 4

*Status: This is the original version (as it was originally made). This item of legislation is currently only available in its original format.*

SCHEDULE 7 PART II NON-PRIMARY ROUTE DIRECTIONAL SIGNS (contd.)

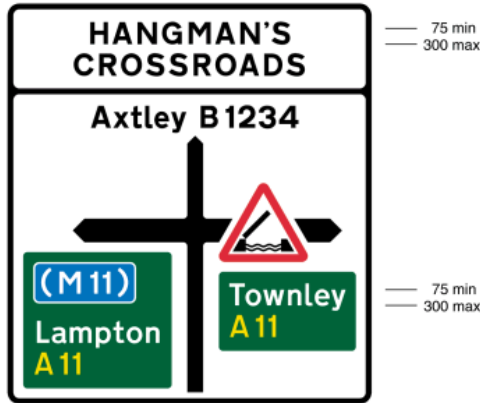

Item	
1	Regulations: None
2	Directions: 13(1)
3	Diagrams: None
4	Permitted variants: Schedule 16, items 3, 5, 16, 18, 19, 20, 21, 22, 24, 25, 26, 27, 30, 31, 32, 34, 35, 37 Junction name and top panel may be omitted
5	Illumination requirements: Schedule 17, item 4

2110  
Junction at named crossroads ahead of a non-primary route with a primary route, on which in one direction there is a lifting bridge and which in the other direction leads to a motorway

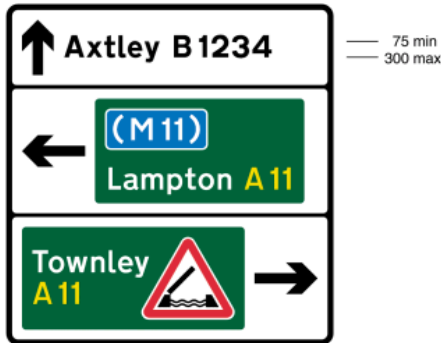

Item	
1	Regulations: None
2	Directions: 13(1)
3	Diagrams: None
4	Permitted variants: Schedule 16, items 3, 5, 12, 16, 19, 20, 21, 22, 24, 25, 26, 27, 29, 30, 31, 32, 34, 35, 36, 37
5	Illumination requirements: Schedule 17, item 4

2111  
Junction at crossroads ahead of a non-primary route with a primary route, on which in one direction there is a lifting bridge and which in the other direction leads to a motorway

**Status:** This is the original version (as it was originally made). This item of legislation is currently only available in its original format.

SCHEDULE 7 PART II NON-PRIMARY ROUTE DIRECTIONAL SIGNS (contd.)

60 min  
300 max



2111.1  
Direction along a non-primary route to a destination shown via a U-turn at a roundabout ahead

Item	
1	Regulations: None
2	Directions: 13(1)
3	Diagrams: None
4	Permitted variants: Schedule 16, items 5, 9, 19, 20, 21, 22, 24, 25, 26, 27, 30, 31, 32, 34, 35
5	Illumination requirements: Schedule 17, item 4

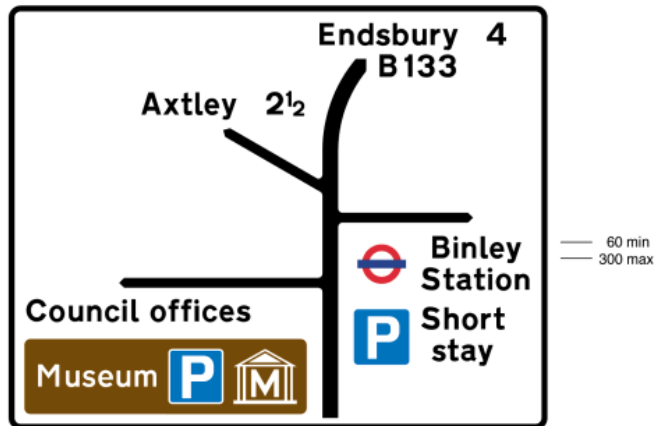

2112  
Staggered junctions ahead between four non-primary routes leading to various destinations including parking for a tourist attraction, short stay parking and a London Underground railway station

Item	
1	Regulations: None
2	Directions: 13(1)
3	Diagrams: None
4	Permitted variants: Schedule 16, items 3, 5, 9, 16, 18, 19, 20, 21, 22, 24, 25, 26, 27, 29, 30, 31, 32, 33, 34, 35, 36, 37
5	Illumination requirements: Schedule 17, item 4

**Status:** This is the original version (as it was originally made). This item of legislation is currently only available in its original format.

SCHEDULE 7 PART II NON-PRIMARY ROUTE DIRECTIONAL SIGNS (contd.)

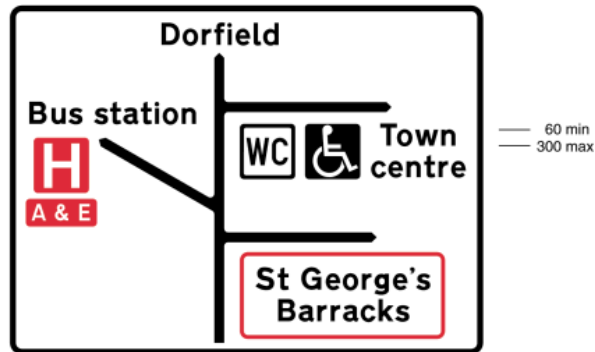

2113

Staggered junctions ahead between four non-primary routes leading to various destinations, including a Ministry of Defence establishment, a hospital with accident and emergency facilities and public toilets with facilities for disabled people

Item	
1	Regulations: None
2	Directions: 13(1)
3	Diagrams: None
4	Permitted variants: Schedule 16, items 3, 5, 16, 18, 19, 20, 21, 22, 24, 25, 26, 27, 28, 29, 30, 31, 32, 34, 35, 36, 37
5	Illumination requirements: Schedule 17, item 4



**Status:** This is the original version (as it was originally made). This item of legislation is currently only available in its original format.

SCHEDULE 7 PART II NON-PRIMARY ROUTE DIRECTIONAL SIGNS (contd.)

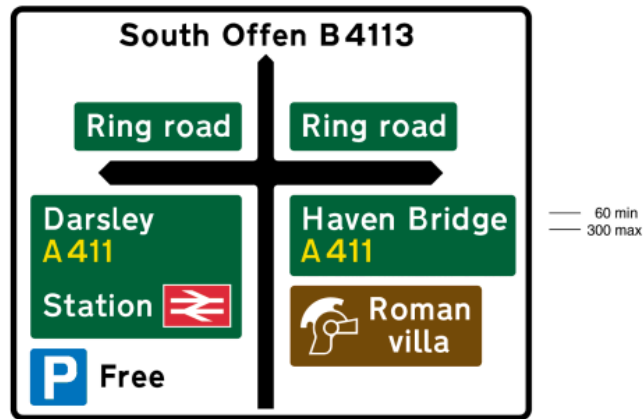

2113.1

Junction at crossroads ahead between a non-primary route and a primary route which is a ring road and which also leads to a railway station and free parking in one direction and to a tourist attraction in the other

Item	
1	Regulations: None
2	Directions: 13(1)
3	Diagrams: None
4	Permitted variants: Schedule 16, Items 3, 5, 16, 18, 19, 20, 21, 22, 24, 25, 26, 27, 29, 30, 31, 32, 33, 34, 35, 36, 37
5	Illumination requirements: Schedule 17, item 4

**Status:** This is the original version (as it was originally made). This item of legislation is currently only available in its original format.

SCHEDULE 7 PART II NON-PRIMARY ROUTE DIRECTIONAL SIGNS (contd.)

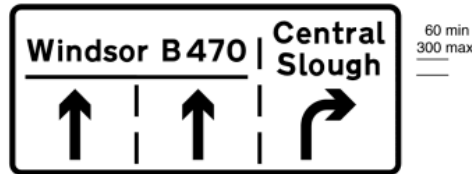

2114

Junction ahead where one lane of a non-primary route is reserved for traffic turning to the right

Item	
1	Regulations: None
2	Directions: 13(1)
3	Diagrams: None
4	Permitted variants: Schedule 16, items 12, 16, 19, 20, 21, 22, 24, 25, 26, 27, 30, 31, 32, 34, 35, 36, 37 The chevron marking shown in diagram 2115.1 may be added and varied as appropriate
5	Illumination requirements: Schedule 17, item 4



2114.1

Appropriate traffic lanes on a non-primary route at a junction or on the approach to a junction leading to the destinations shown (Gantry-mounted sign)

Item	
1	Regulations: None
2	Directions: 13(1)
3	Diagrams: None
4	Permitted variants: Schedule 16, items 16, 19, 20, 21, 22, 30, 34
5	Illumination requirements: Schedule 17, item 4

**Status:** This is the original version (as it was originally made). This item of legislation is currently only available in its original format.

SCHEDULE 7 PART II NON-PRIMARY ROUTE DIRECTIONAL SIGNS (contd.)

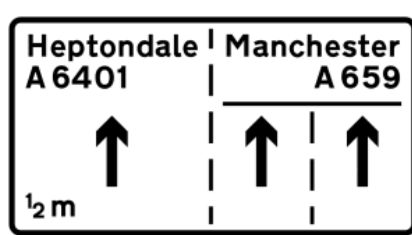

75 min  
300 max

Item	
1	Regulations: None
2	Directions: 13(1)
3	Diagrams: None
4	Permitted variants: Schedule 16, items 7, 16, 19, 20, 21, 22, 24, 25, 26, 30, 31, 32, 34, 35, 36
5	Illumination requirements: Schedule 17, item 4

2115

Grade separated junction 1/2 mile ahead where one lane of a non-primary route is reserved for traffic turning onto another non-primary route

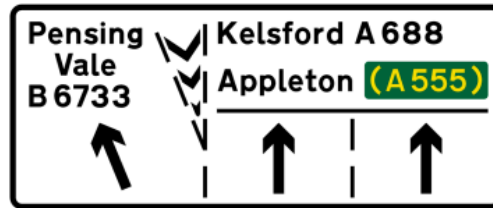

75 min  
300 max

2115.1

Grade separated junction where one lane of a non-primary route is reserved for traffic turning onto another non-primary route

Item	
1	Regulations: None
2	Directions: 13(1)
3	Diagrams: None
4	Permitted variants: Schedule 16, items 16, 19, 20, 21, 22, 24, 25, 26, 30, 31, 32, 34, 35
5	Illumination requirements: Schedule 17, item 4

**Status:** This is the original version (as it was originally made). This item of legislation is currently only available in its original format.

SCHEDULE 7 PART II NON-PRIMARY ROUTE DIRECTIONAL SIGNS (contd.)



2116

Grade separated junction 1/2 mile ahead of two non-primary routes where the left hand direction leads directly to a primary route and a non-primary route and the number of lanes on the main carriageway remains the same through the junction (Gantry-mounted sign)

Item	
1	Regulations: None
2	Directions: 13(1)
3	Diagrams: None
4	Permitted variants: Schedule 16, items 7, 9, 12, 19, 20, 21, 22, 30, 34, 36
5	Illumination requirements: Schedule 17, item 4



2117

Grade separated junction ahead, or directions at a grade separated junction when distance omitted, where the left hand lane of a non-primary route leads directly to another non-primary route and a primary route and the two right hand lanes lead along the main route to another primary route (Gantry-mounted sign)

Item	
1	Regulations: None
2	Directions: 13(1)
3	Diagrams: None
4	Permitted variants: Schedule 16, items 7, 9, 16, 19, 20, 21, 22, 30, 34, 36
5	Illumination requirements: Schedule 17, item 4

**Status:** This is the original version (as it was originally made). This item of legislation is currently only available in its original format.

SCHEDULE 7 PART II NON-PRIMARY ROUTE DIRECTIONAL SIGNS (contd.)



2118

Roundabout ahead with a dedicated lane to a primary route which leads to a motorway and exits to two non-primary routes, one of which leads to car parking in the town centre and to a railway station

Item	
1	Regulations: None
2	Directions: 13(1)
3	Diagrams: None
4	Permitted variants: Schedule 16, items 3, 5, 16, 18, 19, 20, 21, 22, 24, 25, 26, 27, 29, 30, 31, 32, 34, 35, 36, 37
5	Illumination requirements: Schedule 17, item 4



Item	
1	Regulations: None
2	Directions: 13(1)
3	Diagrams: None
4	Permitted variants: Schedule 16, items 3, 5, 16, 18, 19, 20, 21, 22, 24, 25, 26, 27, 29, 30, 31, 32, 34, 35, 36, 37
5	Illumination requirements: Schedule 17, item 4

2119

Mini-roundabout ahead with exits to a non-primary route and a primary route in two directions, one of which leads to an airport

*Status: This is the original version (as it was originally made). This item of legislation is currently only available in its original format.*

SCHEDULE 7 PART II NON-PRIMARY ROUTE DIRECTIONAL SIGNS (contd.)

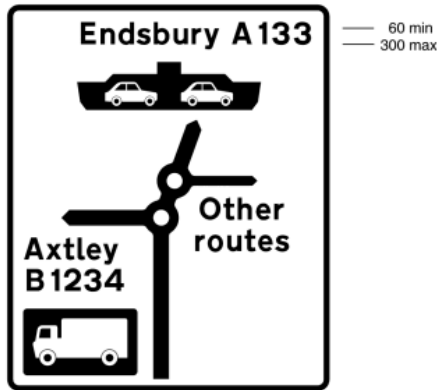

— 60 min  
 — 300 max

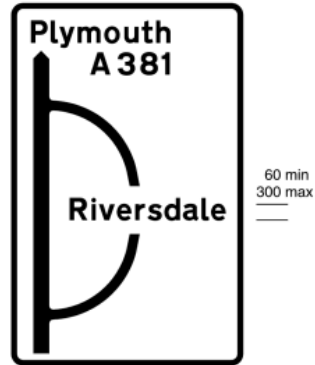

60 min  
 300 max

2120

Double mini-roundabout ahead with exits to three non-primary routes, one of which leads to a car ferry and another is an advisory lorry route

Item	
1	Regulations: None
2	Directions: 13(1)
3	Diagrams: None
4	Permitted variants: Schedule 16, items 3, 5, 16, 18, 19, 20, 21, 22, 24, 25, 26, 27, 28, 30, 31, 32, 34, 35, 36, 37
5	Illumination requirements: Schedule 17, item 4

2121

Junction ahead of a non-primary route with another non-primary route leading to a town or village that has been by-passed

Item	
1	Regulations: None
2	Directions: 13(1)
3	Diagrams: None
4	Permitted variants: Schedule 16, items 3, 5, 16, 18, 19, 20, 21, 22, 24, 30, 31, 32, 34, 35, 36
5	Illumination requirements: Schedule 17, item 4



60 min  
 300 max

2122

Sharp bend in main route at a junction ahead with a minor road

Item	
1	Regulations: None
2	Directions: 13(1)
3	Diagrams: None
4	Permitted variants: Schedule 16, items 3, 5, 16, 18, 19, 20, 21, 22, 24, 25, 26, 27, 30, 31, 32, 34, 35
5	Illumination requirements: Schedule 17, item 4

236

238

**Status:** This is the original version (as it was originally made). This item of legislation is currently only available in its original format.

SCHEDULE 7 PART II NON-PRIMARY ROUTE DIRECTIONAL SIGNS (contd.)



300 min  
1200 max

75 min  
300 max

2123

Distance to a prohibited movement and direction to the destination shown avoiding that prohibition

Item	
1	Regulations: None
2	Directions: 7, 13(1)
3	Diagrams: None
4	Permitted variants: Schedule 16, items 6, 16, 19, 20, 21, 22, 24, 25, 26, 27, 30, 34, 35 The diagram 612 symbol may be varied to a diagram 613 or 614 symbol
5	Illumination requirements: Schedule 17, item 4



75 min  
300 max

300 min  
1200 max

2124

Direction to the destination shown avoiding a prohibited movement ahead

Item	
1	Regulations: None
2	Directions: 7, 13(1)
3	Diagrams: None
4	Permitted variants: Schedule 16, items 16, 19, 20, 21, 22, 24, 25, 26, 27, 30, 34, 35 The diagram 612 symbol may be varied to a diagram 613 symbol
5	Illumination requirements: Schedule 17, item 4



60 min  
240 max

75 min  
300 max

2124.1

Junction ahead of a non-primary route which leads directly onto a motorway, with another non-primary route which should be followed by traffic not wishing or permitted to use the motorway

Item	
1	Regulations: None
2	Directions: 13(1)
3	Diagrams: None
4	Permitted variants: Schedule 16, items 12, 19, 20, 21, 22, 24, 25, 26, 30, 31, 32, 34, 35, 36 The upper directional sign panel may be omitted
5	Illumination requirements: Schedule 17, item 4

*Status: This is the original version (as it was originally made). This item of legislation is currently only available in its original format.*

SCHEDULE 7 PART II NON-PRIMARY ROUTE DIRECTIONAL SIGNS (contd.)



2125  
Direction and distance to a destination on a non-primary route

Item	
1	Regulations: None
2	Directions: 13(2)
3	Diagrams: None
4	Permitted variants: Schedule 16, items 5, 9, 15, 19, 20, 21, 22, 24, 30, 31, 32, 34
5	Illumination requirements: Schedule 17, item 4



2126  
Direction and distances to a destination on a non-primary route and to a tourist attraction

Item	
1	Regulations: None
2	Directions: 13(2)
3	Diagrams: None
4	Permitted variants: Schedule 16, items 5, 9, 15, 19, 20, 21, 22, 24, 30, 31, 32, 34
5	Illumination requirements: Schedule 17, item 4



2126.1  
Direction to a non-primary route

Item	
1	Regulations: None
2	Directions: 13(2)
3	Diagrams: None
4	Permitted variants: Schedule 16, items 3, 5, 12, 19, 20, 21, 22, 24, 25, 26, 30, 31, 32, 34, 35
5	Illumination requirements: Schedule 17, item 4



**Status:** This is the original version (as it was originally made). This item of legislation is currently only available in its original format.

SCHEDULE 7 PART II NON-PRIMARY ROUTE DIRECTIONAL SIGNS (contd.)

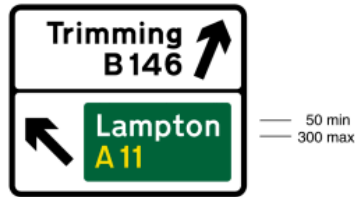

2127  
Directions to non-primary and primary routes

Item	
1	Regulations: None
2	Directions: 13(2)
3	Diagrams: None
4	Permitted variants: Schedule 16, items 3, 5, 12, 19, 20, 21, 22, 24, 25, 26, 27, 30, 31, 32, 34, 35
5	Illumination requirements: Schedule 17, item 4



2128  
The number of a non-primary route leading to a primary route with destinations and distances

Item	
1	Regulations: None
2	Directions: 13(1)
3	Diagrams: None
4	Permitted variants: Schedule 16, items 5, 19, 20, 21, 22, 30
5	Illumination requirements: Schedule 17, item 4



2129  
The number of a non-primary route

Item	
1	Regulations: None
2	Directions: 13(1)
3	Diagrams: None
4	Permitted variants: Schedule 16, items 20, 21, 22
5	Illumination requirements: Schedule 17, item 4

**Status:** This is the original version (as it was originally made). This item of legislation is currently only available in its original format.

SCHEDULE 7 PART II NON-PRIMARY ROUTE DIRECTIONAL SIGNS (contd.)

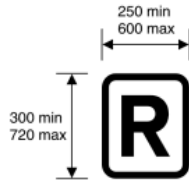

2130  
Non-primary route forming part of a ring road

Item	
1	Regulations: None
2	Directions: 13(1)
3	Diagrams: None
4	Permitted variants: None
5	Illumination requirements: Schedule 17, item 4



2131  
Alternative route from junction ahead to place named

Item	
1	Regulations: None
2	Directions: 13(1)
3	Diagrams: None
4	Permitted variants: Schedule 16, items 3, 5, 12, 19, 20, 21, 22, 30, 32, 34
5	Illumination requirements: Schedule 17, item 4



2132  
Direction of alternative route to place named

Item	
1	Regulations: None
2	Directions: 13(2)
3	Diagrams: None
4	Permitted variants: Schedule 16, items 3, 5, 15, 19, 20, 21, 22, 30, 32, 34
5	Illumination requirements: Schedule 17, item 4



2133  
Junction ahead leading to a London Underground railway station

Item	
1	Regulations: None
2	Directions: 13(1)
3	Diagrams: None
4	Permitted variants: Schedule 16, items 3, 6, 12, 29, 31, 32 The London Underground symbol may be replaced by the railway station symbol shown in diagram 2118 or by a PTE symbol. The railway station symbol may be used in addition to the London Underground or PTE symbol. The name of the station may be varied or omitted. The word 'Station' may be omitted
5	Illumination requirements: Schedule 17, item 4

**Status:** This is the original version (as it was originally made). This item of legislation is currently only available in its original format.

SCHEDULE 7 PART II NON-PRIMARY ROUTE DIRECTIONAL SIGNS (contd.)



2134  
Direction to a railway station

Item	
1	Regulations: None
2	Directions: 13(2)
3	Diagrams: None
4	Permitted variants: Schedule 16, items 3, 6, 15, 29, 31, 32 The PTE symbol may be replaced by another PTE symbol or London Underground symbol or omitted. The name of the station may be added. The railway station symbol may be omitted. The word "Station" may be omitted
5	Illumination requirements: Schedule 17, item 4



2135  
Junction ahead leading to a car ferry

Item	
1	Regulations: None
2	Directions: 13(1)
3	Diagrams: None
4	Permitted variants: Schedule 16, items 3, 6, 12, 28, 31, 32 The left hand car symbol may be replaced by the lorry symbol. The two symbols may be omitted and two lorry symbols or the words "Pedestrian ferry" added on the boat symbol. The name of the ferry or quay may be added above the boat symbol
5	Illumination requirements: Schedule 17, item 4



2136  
Direction to a vehicle ferry

Item	
1	Regulations: None
2	Directions: 13(2)
3	Diagrams: None
4	Permitted variants: Schedule 16, items 3, 6, 15, 28, 31, 32 The car and lorry symbols may be varied to two car symbols or to two lorry symbols. The two symbols may be omitted and the words "Pedestrian ferry" added on the boat symbol. The name of the ferry or quay may be added above the boat symbol
5	Illumination requirements: Schedule 17, item 4

*Status: This is the original version (as it was originally made). This item of legislation is currently only available in its original format.*

SCHEDULE 7 PART II NON-PRIMARY ROUTE DIRECTIONAL SIGNS (contd.)



2137  
Direction to a shopping area which provides a "Shopmobility" service for disabled people approved by the National Federation of Shopmobility

Item	
1	Regulations: None
2	Directions: 13(2)
3	Diagrams: None
4	Permitted variants: Schedule 16, items 15, 28, 29
5	Illumination requirements: Schedule 17, item 4



2137.1  
Junction ahead leading to a shopping area which provides a "Shopmobility" service for disabled people approved by the National Federation of Shopmobility

Item	
1	Regulations: None
2	Directions: 13(1)
3	Diagrams: None
4	Permitted variants: Schedule 16, items 12, 28, 29
5	Illumination requirements: Schedule 17, item 4

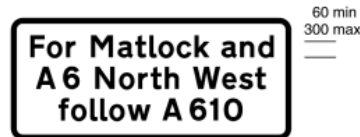

2138  
Route to be followed at junction ahead for destinations that are not otherwise shown on signs for that junction

Item	
1	Regulations: None
2	Directions: 13(1)
3	Diagrams: None
4	Permitted variants: Schedule 16, items 19, 20, 21, 30, 34 A place name may be added between "follow" and the route number. The second route number may be varied to a destination. "follow" and the route may be varied to "leave at next junction", or "leave at" and the name of a junction. The legend "Park and Ride" may be added after "Matlock", or "follow" and the route may be varied to "use" and the Park and Ride symbol shown in diagram 2503 or its permitted variants
5	Illumination requirements: Schedule 17, item 4

**Status:** This is the original version (as it was originally made). This item of legislation is currently only available in its original format.

SCHEDULE 7 PART II NON-PRIMARY ROUTE DIRECTIONAL SIGNS (contd.)



— 60 min  
— 250 max



— 50 min  
— 250 max

2139  
Junction ahead leading to a recycling centre

Item	
1	Regulations: None
2	Directions: 13(1)
3	Diagrams: None
4	Permitted variants: Schedule 16, items 3, 6, 12, 29 "Recycling centre" may be varied to another appropriate description or name, or omitted
5	Illumination requirements: Schedule 17, item 4

2140  
Direction to a recycling centre

Item	
1	Regulations: None
2	Directions: 13(2)
3	Diagrams: None
4	Permitted variants: Schedule 16, items 3, 6, 15, 29 Same as diagram 2139
5	Illumination requirements: Schedule 17, item 4



— 40 min  
— 60 max

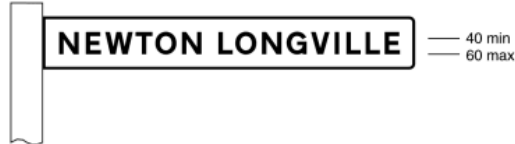

— 40 min  
— 60 max

2141  
Direction for traffic on a minor route to a destination reached along another minor route (Alternative types)

Item	
1	Regulations: None
2	Directions: 13(4)
3	Diagrams: None
4	Permitted variants: Schedule 16, items 3, 5, 15, 19 Destination may be shown in lower case lettering with initial capitals. The shape of the end of the sign may be varied. A thin black border may be added or omitted as appropriate
5	Illumination requirements: Schedule 17, item 9

**Status:** This is the original version (as it was originally made). This item of legislation is currently only available in its original format.

## PART III

### TOURIST DESTINATION SIGNS

SCHEDULE 7 PART III  
TOURIST DESTINATION SIGNS  
(other than on motorways or for pedestrians)

Regulation 11(1)

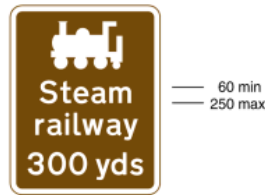

2201  
Distance ahead to a tourist attraction

Item	
1	Regulations: None
2	Directions: 13(3)
3	Diagrams: None
4	Permitted variants: Schedule 16, items 6, 10, 11, 19, 33
5	Illumination requirements: Schedule 17, item 9



2202  
Junction ahead leading to a tourist attraction

Item	
1	Regulations: None
2	Directions: 13(3)
3	Diagrams: None
4	Permitted variants: Schedule 16, items 6, 9, 12, 19, 29, 31, 32, 33, 34 The U-turn arrow shown in diagram 2035 may be substituted for the horizontal arrow and shall always be on the right hand side of the sign. The tourist attraction symbol may be centred below the tourist attraction name
5	Illumination requirements: Schedule 17, item 9



2203  
Direction and distance to a tourist attraction

Item	
1	Regulations: None
2	Directions: 13(3)
3	Diagrams: None
4	Permitted variants: Schedule 16, items 6, 9, 15, 19, 31, 32, 33, 34
5	Illumination requirements: Schedule 17, item 9



2204  
Direction and distance to a  
Tourist Information Point or Centre

Item	
1	Regulations: None
2	Directions: 13(3)
3	Diagrams: None
4	Permitted variants: Schedule 16, items 6, 9, 15, 29, 34 The word "centre" may be added
5	Illumination requirements: Schedule 17, item 9

**Status:** This is the original version (as it was originally made). This item of legislation is currently only available in its original format.

SCHEDULE 7 PART III TOURIST DESTINATION SIGNS (contd.)



2205  
Location of a Tourist Information Point or Centre

Item	
1	Regulations: None
2	Directions: 13(3)
3	Diagrams: None
4	Permitted variants: Schedule 16, Items 3, 6, 11 The word "centre" may be added. The name of a geographical area may be added
5	Illumination requirements: Schedule 17, item 9



2208  
Direction to a tourist attraction indicated by a symbol

Item	
1	Regulations: None
2	Directions: 13(3)
3	Diagrams: None
4	Permitted variants: Schedule 16, items 15, 33
5	Illumination requirements: Schedule 17, item 9

Note: The minimum and maximum dimensions indicated apply to the symbol shown. When the sign is varied to show another symbol, the dimensions shall be varied in accordance with the proportions shown in Schedule 14



2209  
Distance ahead to a tourist attraction

Item	
1	Regulations: None
2	Directions: 13(3)
3	Diagrams: None
4	Permitted variants: Schedule 16, items 5, 19, 33 Opening times may be added. The distance may be replaced by the word "CLOSED"
5	Illumination requirements: Schedule 17, item 9



2210  
Junction ahead leading to or along a route passing through places of interest

Item	
1	Regulations: None
2	Directions: 13(3)
3	Diagrams: None
4	Permitted variants: Schedule 16, items 12, 19, 29 The rose symbol may be varied to the thistle symbol in Scotland, the dragon symbol in Wales or another approved local symbol. The cycle symbol may be added
5	Illumination requirements: Schedule 17, item 9

**Status:** This is the original version (as it was originally made). This item of legislation is currently only available in its original format.

SCHEDULE 7 PART III TOURIST DESTINATION SIGNS (contd.)



2211  
Direction to or along a route  
passing through places of interest

Item	
1	Regulations: None
2	Directions: 13(3)
3	Diagrams: None
4	Permitted variants: Schedule 16, items 15, 19, 29 Same as diagram 2210
5	Illumination requirements: Schedule 17, item 9



2212  
Direction along a route  
passing through places of interest

Item	
1	Regulations: None
2	Directions: 13(3)
3	Diagrams: None
4	Permitted variants: Schedule 16, item 15 Same as diagram 2210. The symbol may be placed alongside the legend at the end of the sign opposite to the chevron
5	Illumination requirements: Schedule 17, item 9



2213  
Junction ahead leading to a route  
of special interest to tourists

Item	
1	Regulations: None
2	Directions: 13(3)
3	Diagrams: None
4	Permitted variants: Schedule 16, items 3, 5, 12, 19, 29 Same as diagram 2210. The legend may be varied to "Tourist route" or a route title. "Tourist" may be varied to "Scenic" or "Coastal". "route" may be varied to "trail"
5	Illumination requirements: Schedule 17, item 9



2214  
Direction to or along a route  
of special interest to tourists

Item	
1	Regulations: None
2	Directions: 13(3)
3	Diagrams: None
4	Permitted variants: Schedule 16, items 3, 5, 15, 19, 29 Same as diagram 2213
5	Illumination requirements: Schedule 17, item 9



**Status:** This is the original version (as it was originally made). This item of legislation is currently only available in its original format.

SCHEDULE 7 PART III TOURIST DESTINATION SIGNS (contd.)



2215  
Junction ahead leading to a town or geographical area containing several tourist attractions and a Tourist Information Point or Centre

Item	
1	Regulations: None
2	Directions: 13(3)
3	Diagrams: None
4	Permitted variants: Schedule 16, items 3, 5, 12, 19, 29, 33 The number of tourist attractions shown on the lower part of the sign may be varied, but shall not exceed five
5	Illumination requirements: Schedule 17, item 9



2216  
Junction ahead leading to tourist attractions and a Tourist Information Point or Centre reached in different directions

Item	
1	Regulations: None
2	Directions: 13(3)
3	Diagrams: None
4	Permitted variants: Schedule 16, items 3, 6, 12, 16, 19, 29, 33, 34
5	Illumination requirements: Schedule 17, item 9

**Status:** This is the original version (as it was originally made). This item of legislation is currently only available in its original format.

SCHEDULE 7 PART III TOURIST DESTINATION SIGNS (contd.)



Item	
1	Regulations: None
2	Directions: 13(3)
3	Diagrams: None
4	Permitted variants: Schedule 16, items 19, 20, 21, 33 The route number may be varied to a place name or to a symbol shown in Schedule 14 or other approved symbol. A place name may be added to the route number. "railway museum" may be varied to no more than two tourist attractions with "and" or "&" inserted between the two names. "follow" and the route number may be varied to "leave at next junction", or "leave at" and the name of the junction, or varied to "use" and the Park and Ride symbol shown in diagram 2503, or its permitted variants, with a white border added. The Park and Ride symbol may be varied to a white panel with the "P" symbol shown in diagram 2505 and a description of a parking place
5	Illumination requirements: Schedule 17, item 9

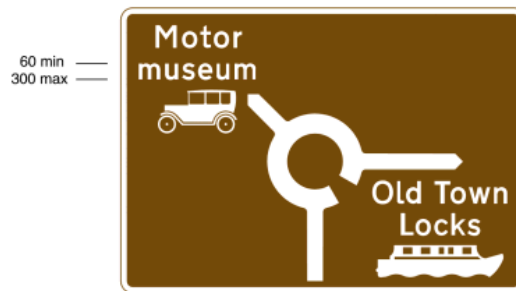

2218  
Roundabout ahead leading to tourist attractions shown

Item	
1	Regulations: None
2	Directions: 13(3)
3	Diagrams: None
4	Permitted variants: Schedule 16, items 3, 5, 16, 18, 19, 31, 32, 33, 34 The tourist attraction symbol may be placed to the right of the associated legend when indicating a direction ahead or to the left, and placed to the left of the associated legend when indicating a direction to the right
5	Illumination requirements: Schedule 17, item 9

**Status:** This is the original version (as it was originally made). This item of legislation is currently only available in its original format.

## PART IV

### SIGNS FOR SERVICES AND TOURIST FACILITIES

#### SCHEDULE 7 PART IV SIGNS FOR SERVICES AND TOURIST FACILITIES (other than on motorways)

Regulation 11(1)



2301  
Distance ahead to a camping and caravan site licensed under the Caravan Sites and Control of Development Act 1960 and/or the Public Health Act 1936 and having a minimum of 20 pitches for casual overnight use

Item	
1	Regulations: None
2	Directions: 13(3)
3	Diagrams: None
4	Permitted variants: Schedule 16, items 6, 10, 11, 19 Either the caravan or the tent symbol may be omitted. In Scotland the symbol shown in diagram T301.1 may be added
5	Illumination requirements: Schedule 17, item 4



2302  
Direction and distance to a camping and caravan site as defined in the caption under diagram 2301

Item	
1	Regulations: None
2	Directions: 13(3)
3	Diagrams: None
4	Permitted variants: Schedule 16, items 6, 9, 15, 19 Same as diagram 2301. The distance may be placed to the right of the symbols
5	Illumination requirements: Schedule 17, item 4



2303  
Distance ahead to a hostel managed by the Youth Hostels Association or the Scottish Youth Hostels Association

Item	
1	Regulations: None
2	Directions: 13(3)
3	Diagrams: None
4	Permitted variants: Schedule 16, items 6, 10, 11 "Youth Hostel" may be varied to "Tourist hostel" in which case the symbol shall be omitted
5	Illumination requirements: Schedule 17, item 4



2304  
Direction and distance to a hostel as defined in the caption under diagram 2303

Item	
1	Regulations: None
2	Directions: 13(3)
3	Diagrams: None
4	Permitted variants: Schedule 16, items 6, 9, 15, 29 Same as diagram 2303
5	Illumination requirements: Schedule 17, item 4

**Status:** This is the original version (as it was originally made). This item of legislation is currently only available in its original format.

SCHEDULE 7 PART IV SIGNS FOR SERVICES AND TOURIST FACILITIES (contd.)



2305  
Distance ahead to a picnic area

Item	
1	Regulations: None
2	Directions: 13(3)
3	Diagrams: None
4	Permitted variants: Schedule 16, items 6, 10, 11, 19
5	Illumination requirements: Schedule 17, item 9



2306  
Direction and distance to a picnic area

Item	
1	Regulations: None
2	Directions: 13(3)
3	Diagrams: None
4	Permitted variants: Schedule 16, items 6, 9, 15, 19, 29
5	Illumination requirements: Schedule 17, item 9

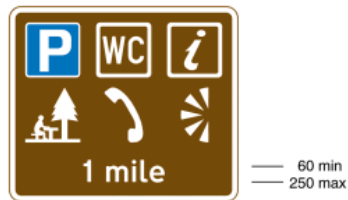

2307  
Distance ahead to a parking place with public toilets,  
Tourist Information Point or Centre, picnic site,  
public telephone and viewpoint

Item	
1	Regulations: None
2	Directions: 13(3)
3	Diagrams: None
4	Permitted variants: Schedule 16, items 6, 10, 11, 28 The name of a geographical area may be added above the top line of symbols. The wheelchair symbol (denoting facilities for disabled people) may be added when the "WC" symbol is shown. The green on white recycling centre symbol shown in diagram 2027.1 may be added. Any of the symbols may be omitted but there shall be at least two symbols on the sign including the "P" and either the "i", picnic area or viewpoint symbol
5	Illumination requirements: Schedule 17, item 4

**Status:** This is the original version (as it was originally made). This item of legislation is currently only available in its original format.

SCHEDULE 7 PART IV SIGNS FOR SERVICES AND TOURIST FACILITIES (contd.)



150 min —  
300 max —

2308.1

Junction ahead leading to a small town or village not on a main through route, which provides parking, public toilets, refreshments and fuel during normal shop opening hours at least

Item	
1	Regulations: None
2	Directions: 13(3)
3	Diagrams: None
4	Permitted variants: Schedule 16, items 3, 5, 12, 19, 28 The wheelchair symbol (denoting facilities for disabled people) may be added when the "WC" symbol is shown. The spoon and fork (denoting restaurant), bed (denoting hotel or other overnight accommodation) or tourist information "i" symbols shall be omitted where those facilities are not provided. The remaining symbols may be shown in a single row. "local" shall be varied to "Local" when place name is omitted. In Wales the words "local facilities" may be omitted
5	Illumination requirements: Schedule 17, item 4



2309.1

Direction and distance to a small town or village offering the facilities indicated on the sign in diagram 2308.1

Item	
1	Regulations: None
2	Directions: 13(3)
3	Diagrams: None
4	Permitted variants: Schedule 16, items 5, 9, 15, 19 "local" shall be varied to "Local" when place name is omitted
5	Illumination requirements: Schedule 17, item 4

**Status:** This is the original version (as it was originally made). This item of legislation is currently only available in its original format.

SCHEDULE 7 PART IV SIGNS FOR SERVICES AND TOURIST FACILITIES (contd.)



2310.1  
Distance ahead to a named motorway service area located on a road that is not a motorway at which fuel, parking, toilets and facilities for disabled persons are available, and refreshments, overnight accommodation, LPG fuel and a Tourist Information Point or Centre may be available, 24 hours a day throughout the year (Sign on primary or non-primary route)

Item	
1	Regulations: None
2	Directions: 13(3)
3	Diagrams: None
4	Permitted variants: Schedule 16, item 8 The LPG fuel, "i" and bed symbols may be omitted as appropriate. "Puddleworth" shall be varied to another geographical name as appropriate
5	Illumination requirements: Schedule 17, item 4



2311.1  
Entrance or direction to a named motorway service area located on a road that is not a motorway (Sign on a primary or non-primary route)

Item	
1	Regulations: None
2	Directions: 13(3)
3	Diagrams: None
4	Permitted variants: Schedule 16, item 15 "Puddleworth" may be omitted or varied to another geographical name as appropriate. "services" shall be varied to "Services" when the geographical name is omitted
5	Illumination requirements: Schedule 17, item 4



2311.2  
Same as diagram 2311.1 or junction ahead leading to a named motorway service area located on a road that is not a motorway (Sign on a primary or non-primary route)

Item	
1	Regulations: None
2	Directions: 13(3)
3	Diagrams: None
4	Permitted variants: Schedule 16, item 12 Same as diagram 2311.1. The inclined arrow may be omitted and the U-turn arrow shown in diagram 2035 added to the right of the legend
5	Illumination requirements: Schedule 17, item 4

**Status:** This is the original version (as it was originally made). This item of legislation is currently only available in its original format.

SCHEDULE 7 PART IV SIGNS FOR SERVICES AND TOURIST FACILITIES (contd.)



2313.1

Distance ahead to services at which fuel, parking, restaurant facilities and toilets are available for all vehicles at all times on every day except Christmas Day, Boxing Day and New Year's Day

Item	
1	Regulations: None
2	Directions: 13(3)
3	Diagrams: None
4	Permitted variants: Schedule 16, item 8 "Services" may be varied to a geographical name and "services". The cup symbol (denoting light refreshments) may be substituted for the spoon and fork symbol. The bed symbol (denoting hotel or other overnight accommodation), the wheelchair symbol (denoting facilities for disabled people) or both may be added. The symbol for LPG fuel shown in diagram 2310.1 may be added except that it shall be coloured black on a white background. The tourist information "i" symbol shall be omitted where this facility is not provided
5	Illumination requirements: Schedule 17, item 4



2313.2

Direction to services at which fuel, parking, light refreshments and toilets are available for all vehicles at all times on every day except Christmas Day, Boxing Day and New Year's Day

Item	
1	Regulations: None
2	Directions: 13(3)
3	Diagrams: None
4	Permitted variants: Schedule 16, items 12, 28 "Services" may be varied to a geographical name and "services". The spoon and fork symbol (denoting restaurant) may be substituted for the cup symbol. The bed symbol (denoting hotel or other overnight accommodation) may be added. The symbol for LPG fuel shown in diagram 2310.1 may be added except that it shall be coloured black on a white background. The wheelchair and tourist information "i" symbols shall be omitted where these facilities are not provided
5	Illumination requirements: Schedule 17, item 4

**Status:** This is the original version (as it was originally made). This item of legislation is currently only available in its original format.

SCHEDULE 7 PART IV SIGNS FOR SERVICES AND TOURIST FACILITIES (contd.)

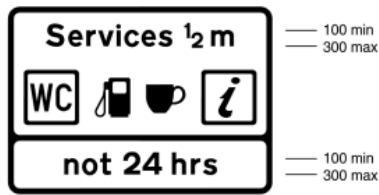

2313.3

Distance ahead to services not open for 24 hours but where fuel, parking, light refreshments and toilets are available for all vehicles at least between 8 am and 8 pm on every day except Christmas Day, Boxing Day and New Year's Day

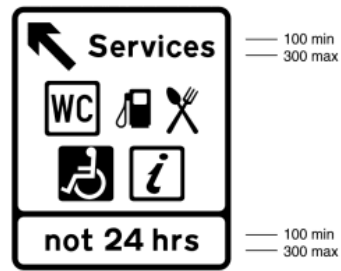

2313.4

Direction to services not open for 24 hours but where fuel, parking, restaurant facilities and toilets are available for all vehicles at least between 8 am and 8 pm on every day except Christmas Day, Boxing Day and New Year's Day

Item	
1	Regulations: None
2	Directions: 13(3)
3	Diagrams: None
4	Permitted variants: Schedule 16, item 8 "Services" may be varied to a geographical name and "services". The spoon and fork symbol (denoting restaurant) may be substituted for the cup symbol. The bed symbol (denoting hotel or other overnight accommodation), the wheelchair symbol (denoting facilities for disabled people) or both may be added. The symbol for LPG fuel shown in diagram 2310.1 may be added except that it shall be coloured black on a white background. The tourist information "i" symbol shall be omitted where this facility is not provided. The phrase "not 24 hrs" shall be varied to "Fuel only 24 hrs" when fuel only is available at all times except Christmas Day, Boxing Day and New Year's Day
5	Illumination requirements: Schedule 17, item 4

Item	
1	Regulations: None
2	Directions: 13(3)
3	Diagrams: None
4	Permitted variants: Schedule 16, items 12, 28 "Services" may be varied to a geographical name and "services". The cup symbol (denoting light refreshments) may be substituted for the spoon and fork symbol. The bed symbol (denoting hotel or other overnight accommodation) may be added. The symbol for LPG fuel shown in diagram 2310.1 may be added except that it shall be coloured black on a white background. The wheelchair and tourist information "i" symbols shall be omitted where these facilities are not provided. The phrase "not 24 hrs" shall be varied to "Fuel only 24 hrs" when fuel only is available at all times except Christmas Day, Boxing Day and New Year's Day
5	Illumination requirements: Schedule 17, item 4



**Status:** This is the original version (as it was originally made). This item of legislation is currently only available in its original format.

SCHEDULE 7 PART IV SIGNS FOR SERVICES AND TOURIST FACILITIES (contd.)



2313.5

Distance ahead to services at which fuel, parking, light refreshments and toilets are available for goods vehicles at all times on every day except Christmas Day, Boxing Day and New Year's Day

Item	
1	Regulations: None
2	Directions: 13(3)
3	Diagrams: None
4	Permitted variants: Schedule 16, item 8 "Services" may be varied to a geographical name and "services". The lorry symbol shall be varied to the lorry symbol with the red bar shown in diagram 2313.6 and the words "Lorries only" omitted where facilities are provided for vehicles other than goods vehicles. The spoon and fork symbol (denoting restaurant) may be substituted for the cup symbol. The bed symbol (denoting hotel or other overnight accommodation), the wheelchair symbol (denoting facilities for disabled people) or both may be added. The symbol for LPG fuel shown in diagram 2310.1 may be added except that it shall be coloured black on a white background. The tourist information "i" symbol shall be omitted where this facility is not provided. The phrase "not 24 hrs" shall be added in a panel at the bottom of the sign as shown in diagram 2313.3 where the services are not open for 24 hours but where the facilities are available between at least 8 am and 8 pm. The phrase "not 24 hrs" shall be varied to "Fuel only 24 hrs" when fuel only is available at all times except Christmas Day, Boxing Day and New Year's Day
5	Illumination requirements: Schedule 17, item 4

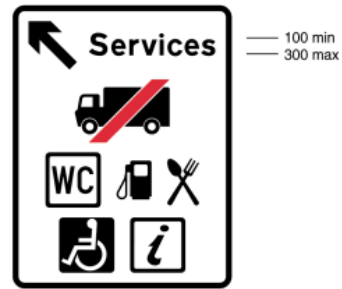

2313.6

Direction to services at which fuel, parking, restaurant facilities and toilets are available for vehicles other than goods vehicles at all times on every day except Christmas Day, Boxing Day and New Year's Day

Item	
1	Regulations: None
2	Directions: 13(3)
3	Diagrams: None
4	Permitted variants: Schedule 16, items 12, 28 "Services" may be varied to a geographical name and "services". The lorry symbol shown in diagram 2313.5 and the words "Lorries only" shall be substituted for the lorry symbol with the red bar where the facilities provided are primarily for heavy goods vehicles. The cup symbol (denoting light refreshments) may be substituted for the spoon and fork symbol. The bed symbol (denoting hotel or other overnight accommodation) may be added. The symbol for LPG fuel shown in diagram 2310.1 may be added except that it shall be coloured black on a white background. The wheelchair and tourist information "i" symbols shall be omitted where these facilities are not provided. The phrase "not 24 hrs" shall be added in a panel at the bottom of the sign as shown in diagram 2313.4 where the services are not open for 24 hours but where the facilities are available between at least 8 am and 8 pm. The phrase "not 24 hrs" shall be varied to "Fuel only 24 hrs" when fuel only is available at all times except Christmas Day, Boxing Day and New Year's Day
5	Illumination requirements: Schedule 17, item 4

**Status:** This is the original version (as it was originally made). This item of legislation is currently only available in its original format.

SCHEDULE 7 PART IV SIGNS FOR SERVICES AND TOURIST FACILITIES (contd.)



2314.1  
Entrance or direction to services indicated by a sign shown in diagram 2313.1, 2313.2, 2313.3, 2313.4, 2313.5 or 2313.6

Item	
1	Regulations: None
2	Directions: 13(3)
3	Diagrams: None
4	Permitted variants: Schedule 16, item 15 "Services" may be varied to a geographical name and "services"
5	Illumination requirements: Schedule 17, item 4



2314.2  
Same as diagram 2314.1 or junction ahead leading to services indicated by a sign shown in diagram 2313.1, 2313.2, 2313.3, 2313.4, 2313.5 or 2313.6

Item	
1	Regulations: None
2	Directions: 13(3)
3	Diagrams: None
4	Permitted variants: Schedule 16, item 12 Same as diagram 2314.1. The inclined arrow may be omitted and the U-turn arrow shown in diagram 2111.1 added to the right of the legend
5	Illumination requirements: Schedule 17, item 4



2322  
Direction to a public telephone

Item	
1	Regulations: None
2	Directions: 13(2)
3	Diagrams: None
4	Permitted variants: Schedule 16, items 3, 6, 15, 28, 29 "Payphone" may be omitted or varied to "Cardphone"
5	Illumination requirements: Schedule 17, item 9



2323  
Direction to public toilets with facilities for disabled people

Item	
1	Regulations: None
2	Directions: 13(2)
3	Diagrams: None
4	Permitted variants: Schedule 16, items 3, 6, 15, 28 The wheelchair symbol may be omitted. The words "Ladies" or "Gents" may be added
5	Illumination requirements: Schedule 17, item 9

**Status:** This is the original version (as it was originally made). This item of legislation is currently only available in its original format.

SCHEDULE 7 PART IV SIGNS FOR SERVICES AND TOURIST FACILITIES (contd.)



60 min  
300 max



50 min  
300 max

2324  
Junction ahead leading to overnight accommodation

Item	
1	Regulations: None
2	Directions: 13(3)
3	Diagrams: None
4	Permitted variants: Schedule 16, items 3, 6, 12, 19, 28, 29, 31, 32, 34 The name may be varied to a generic description of the overnight accommodation. The bed symbol may be omitted. A symbol shown in Schedule 14 or other approved symbol may be added when the bed symbol is shown. The U-turn arrow shown in diagram 2035 may be substituted for the horizontal arrow and shall always be on the right hand side of the sign
5	Illumination requirements: Schedule 17, item 4

2325  
Direction to overnight accommodation

Item	
1	Regulations: None
2	Directions: 13(3)
3	Diagrams: None
4	Permitted variants: Schedule 16, items 3, 6, 15, 19, 28, 29, 31, 32, 34 The name may be varied to a generic description of the overnight accommodation. The bed symbol may be omitted. A symbol shown in Schedule 14 or other approved symbol may be added when the bed symbol is shown
5	Illumination requirements: Schedule 17, item 4



60 min  
300 max



50 min  
300 max

2326  
Junction ahead leading to restaurant

Item	
1	Regulations: None
2	Directions: 13(3)
3	Diagrams: None
4	Permitted variants: Schedule 16, items 3, 6, 12, 19, 29, 31, 32, 34 The spoon and fork symbol may be varied to the cup symbol shown in diagram 2327 when the sign indicates light refreshment facilities. The name may be varied to a generic description of the refreshment facilities. The spoon and fork symbol may be omitted. A symbol shown in Schedule 14 or other approved symbol may be added when the spoon and fork or cup symbol is shown. The horizontal arrow may be omitted and the U-turn arrow shown in diagram 2035 added to the right of the legend, with any associated symbol placed to the left of the legend
5	Illumination requirements: Schedule 17, item 4

2327  
Direction to light refreshment facilities

Item	
1	Regulations: None
2	Directions: 13(3)
3	Diagrams: None
4	Permitted variants: Schedule 16, items 3, 6, 15, 19, 29, 31, 32, 34 The cup symbol may be varied to the spoon and fork symbol shown in diagram 2326 when the sign indicates a restaurant. The name may be varied to a generic description of the refreshment facilities. The cup symbol may be omitted. A symbol shown in Schedule 14 or other approved symbol may be added when the cup or spoon and fork symbol is shown
5	Illumination requirements: Schedule 17, item 4

**Status:** This is the original version (as it was originally made). This item of legislation is currently only available in its original format.

SCHEDULE 7 PART IV SIGNS FOR SERVICES AND TOURIST FACILITIES (contd.)



2328

Junction ahead leading to a small town or village not on a main through route, which provides tourist information and overnight accommodation

Item	
1	Regulations: None
2	Directions: 13(3)
3	Diagrams: None
4	Permitted variants: Schedule 16, items 3, 5, 12, 19, 28 The phrase "historic market town" may be varied as appropriate or omitted. The legend "Hotel and B & B" may be varied to "Hotel" or "B & B" or omitted. The bed symbol may be omitted when the legend "Hotel and B & B" is omitted. Additional symbols shown in Schedule 14 or other approved symbols may be added. No more than four symbols shall be shown on the sign except that five symbols may be shown when either "historic market town" or "Hotel and B & B" is omitted, or six symbols shown when both are omitted
5	Illumination requirements: Schedule 17, item 4



2329

Direction to a small town or village not on a main through route, which provides tourist information and overnight accommodation

Item	
1	Regulations: None
2	Directions: 13(3)
3	Diagrams: None
4	Permitted variants: Schedule 16, items 3, 5, 15, 19, 28 The bed symbol may be omitted. Additional symbols shown in Schedule 14 or other approved symbols may be added provided that the total number of symbols shown on the sign does not exceed six
5	Illumination requirements: Schedule 17, item 4



2330

Services are not available on motorway ahead

Item	
1	Regulations: None
2	Directions: 13(3)
3	Diagrams: None
4	Permitted variants: Schedule 16, item 20 The route number may be varied to "motorway"
5	Illumination requirements: Schedule 17, item 4

**Status:** This is the original version (as it was originally made). This item of legislation is currently only available in its original format.

## PART V

### BOUNDARY SIGNS

SCHEDULE 7 PART V  
BOUNDARY SIGNS  
(other than on motorways)

Regulation 11(1)

CAPITAL  
LETTER  
HEIGHT  
50 min



CAPITAL  
LETTER  
HEIGHT  
70 min

- 2401
- (a) Boundary of a country; or
  - (b) boundary of the area of a county, district or London borough council in England; or
  - (c) boundary of the area of a council in Scotland; or
  - (d) boundary of the area of a county or county borough council in Wales

Item	
1	Regulations: 13(2), 13(4), 13(7)
2	Directions: 13(3)
3	Diagrams: None
4	<p>Permitted variants: Schedule 16, item 19 The arms or logo may be omitted or varied as appropriate. "Welcome to" may be omitted or varied to a similar phrase. The place name may be preceded by "County of" or "Welcome to the County of" or similar phrase. The place name may be followed by "County Council" or "County Council welcomes you" or similar phrase. "County" may be varied to:</p> <ol style="list-style-type: none"> <li>1. "Borough"</li> <li>2. "District"</li> <li>3. "Metropolitan Borough"</li> <li>4. "Metropolitan District"</li> <li>5. "London Borough"</li> <li>6. Other appropriate description of a unitary authority administrative area or a London borough</li> </ol> <p>A phrase denoting an item of local geographical or historical interest may be added. A reference to not more than two places outside the United Kingdom with which the local authority is twinned may be added in the manner shown in diagram 2403.1. The number of words in addition to the place name should not exceed eight. The legend, border and background may be in any contrasting colours except red. The border may be omitted. The shape and layout of the sign may be varied. The relative sizes of lettering on different parts of the sign may be varied provided the place name remains the most prominent feature</p>
5	Illumination requirements: Schedule 17, item 9

*Status: This is the original version (as it was originally made). This item of legislation is currently only available in its original format.*

SCHEDULE 7 PART V BOUNDARY SIGNS (contd.)



2402.1  
Name of a town or village commencing immediately ahead (Alternative types)

2403.1  
Name of a town or village commencing immediately ahead, together with extra local information

Item	
1	Regulations: None
2	Directions: 13(3), 42(6), 42(7)
3	Diagrams: None
4	Permitted variants: Schedule 16, item 19 "Welcome to" may be omitted or varied to a similar phrase. The legend "City of" or "Welcome to the City of" may precede the place name. "Please drive carefully" may be omitted or varied to "Thank you for driving carefully" or another road safety message of not more than five words. When "Welcome to" is omitted, a phrase denoting an item of local geographical or historical interest may be added above the place name and may be in the style of "Market town of" or other appropriate description of not more than five words. The relative sizes of lettering on different parts of the sign may be varied provided the place name remains the most prominent feature
5	Illumination requirements: Schedule 17, item 9

Item	
1	Regulations: 13(2), 13(4), 13(7)
2	Directions: 13(3), 42(8)
3	Diagrams: None
4	Permitted variants: Schedule 16, items 19, 33 The arms may be omitted, varied as appropriate, or varied to a logo or pictorial representation of a local landmark or historical feature. The district council name may be omitted or varied to that of a borough council, metropolitan district council, metropolitan borough council, London borough or other unitary authority. "Welcome to" may be omitted or varied to a similar phrase. The legend "City of" or "Welcome to the City of" may precede the place name. The place name may be varied to the name of a river, inland waterway, bridge or tunnel. The number of tourist attraction symbols may be varied but shall not exceed three. The tourist attraction panel may be omitted. "Please drive carefully" may be omitted or varied to "Thank you for driving carefully" or another road safety message. A phrase denoting an item of local geographical or historical interest may be added and may be in the style of "Market town of" or other appropriate description. "Twinned with" may be varied to "Twin town" or "Twin towns". The name of the twin town shall be varied as appropriate. The names of additional twin towns may be added. Flags, arms or logos associated with the twin towns may be added. The reference to twin towns may be omitted. The legend, border and background, other than the brown tourist panel, may be in any contrasting colours except red. The border may be omitted. The shape and layout of the sign may be varied. The relative sizes of lettering on different parts of the sign may be varied provided the place name remains the most prominent feature
5	Illumination requirements: Schedule 17, item 9

**Status:** This is the original version (as it was originally made). This item of legislation is currently only available in its original format.

## PART VI

### DIRECTIONAL SIGNS TO PARKING PLACE

#### SCHEDULE 7 PART VI DIRECTIONAL SIGNS TO PARKING PLACES

Regulation 11(1)

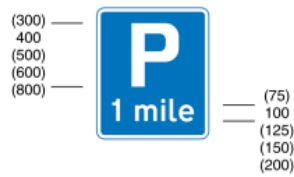

2501  
Distance to a parking place ahead

Item	
1	Regulations: None
2	Directions: 13(3)
3	Diagrams: None
4	Permitted variants: Schedule 16, items 6, 10, 11
5	Illumination requirements: Schedule 17, item 4



2502  
Distance to a commercial vehicles parking place ahead with public toilets and telephones

Item	
1	Regulations: None
2	Directions: 13(3)
3	Diagrams: None
4	Permitted variants: Schedule 16, items 6, 10, 11 The lorry or "WC" or telephone symbol may be omitted. The recycling centre symbol shown in diagram 2139 may be added. The "i" symbol shown in diagram 2313.1 may be added where the parking place includes a general information point not associated with tourist attractions
5	Illumination requirements: Schedule 17, item 4



2503  
Distance to a parking place ahead from which a 'Park and Ride' scheme operates

Item	
1	Regulations: 24(1)
2	Directions: None
3	Diagrams: None
4	Permitted variants: Schedule 16, items 6, 19, 28 The bus symbol may be varied to the tram symbol shown in diagram 953.1, the railway station symbol shown in diagram 2113.1, the London Underground symbol shown in diagram 2606 or a PTE symbol. The word "Free" may be added. "Park and Ride" may be varied to "Park & Ride". An arrow pointing in the appropriate direction may be added or alternatively the U-turn arrow shown in diagram 2510 may be placed on the right hand side of the sign and the bus symbol reversed as shown in diagram 2504. The distance may be omitted when an arrow or U-turn arrow is added. The days and times of operation may be added
5	Illumination requirements: Schedule 17, item 4



2504  
Direction to a parking place from which a 'Park and Ride' scheme operates

Item	
1	Regulations: 24(1)
2	Directions: 13(3)
3	Diagrams: None
4	Permitted variants: Schedule 16, items 3, 6, 15, 19, 28 Same as diagram 2503 except in respect of the addition of an arrow or a U-turn arrow
5	Illumination requirements: Schedule 17, item 4

**Status:** This is the original version (as it was originally made). This item of legislation is currently only available in its original format.

SCHEDULE 7 PART VI DIRECTIONAL SIGNS TO PARKING PLACES (contd.)



2505  
Directions to different types of parking place from a junction ahead

Item	
1	Regulations: 13(2), 13(7), 19(4), 24(1)
2	Directions: 13(3), 56
3	Diagrams: None
4	<p>Permitted variants: Schedule 16, items 3, 6, 12, 16, 28, 31, 34, 38 The permitted variants shown below apply to each parking place indicated on the sign.</p> <p>The name or location of the parking place may be added. One of the following legends may be used or the legend may be omitted:</p> <ol style="list-style-type: none"> <li>"Free"</li> <li>"Shoppers"</li> <li>"Commuters"</li> <li>"Long stay"</li> <li>"Short stay"</li> <li>"Pay and display"</li> <li>"Multi-storey"</li> </ol> <p>No more than two of the following symbols may be shown:</p> <ol style="list-style-type: none"> <li>Pedal cycle shown in diagram 968</li> <li>Bus shown in diagram 969</li> <li>Goods vehicle shown in diagram 804.1</li> <li>Car shown in diagram 804.2</li> <li>Caravan drawn by a car shown in diagram 804.3</li> <li>Motor cycle shown in diagram 804.4</li> <li>Tourist information "T" shown in diagram 2313.1</li> </ol> <p>The total number of spaces in the parking place may be indicated in white figures in the bottom right hand corner of the "P" symbol as shown in diagram 2506.</p> <p>A blue panel with the legend "Secured" may be added to the "P" symbol in the manner shown in diagrams 2511 and 2512 to indicate a secured car park approved by the police under the ACPO secured car park scheme.</p> <p>One of the following variable legends may be displayed in red or green characters in the manner shown in diagram 2509.1, or in red, green, white, off-white or yellow characters on a black background if the construction or method of operation prevents it from being so displayed:</p> <ol style="list-style-type: none"> <li>"FULL"</li> <li>"CLOSED"</li> <li>"NEARLY FULL" on one or two lines</li> <li>"SPACES"</li> </ol> <p>The arrow symbols may be omitted when "FULL" or "CLOSED" is displayed</p>
5	Illumination requirements: Schedule 17, item 4



2505.1  
Same as diagram 2505 with an indication of the general location of parking places

Item	
1	Regulations: 13(2), 13(7), 19(4), 24(1)
2	Directions: 13(3), 56
3	Diagrams: None
4	<p>Permitted variants: Schedule 16, items 3, 6, 12, 16, 19, 28, 31, 34, 38 Same as diagram 2505 except in respect of the indication of the total number of spaces in the "P" symbol. A second "P" symbol may be added to the top panel in the manner shown in diagram 2509.1. "Long stay" or "Short stay" may be added to or substituted for "Town centre" in the top panel when geographical names are substituted for "Long stay" and "Short stay" in the other two panels</p>
5	Illumination requirements: Schedule 17, item 4



2506  
Direction to a parking place for shoppers and showing the total number of parking spaces

Item	
1	Regulations: 13(2), 13(7), 19(4), 24(1)
2	Directions: 13(3), 56
3	Diagrams: None
4	<p>Permitted variants: Schedule 16, items 3, 6, 12, 28, 31, 34, 38 Same as diagram 2505. The number of spaces may be varied or omitted</p>
5	Illumination requirements: Schedule 17, item 4



**Status:** This is the original version (as it was originally made). This item of legislation is currently only available in its original format.

SCHEDULE 7 PART VI DIRECTIONAL SIGNS TO PARKING PLACES (contd.)



2507  
Direction to a parking place available only on the day specified

Item	
1	Regulations: 13(2), 13(7), 19(4), 24(1)
2	Directions: 13(3), 56
3	Diagrams: None
4	Permitted variants: Schedule 16, items 3, 6, 15, 28, 31, 34, 38 Same as diagram 2505
5	Illumination requirements: Schedule 17, item 4



2508  
Direction and distance to a multi-storey parking place

Item	
1	Regulations: 13(2), 13(7), 19(4), 24(1)
2	Directions: 13(3), 56
3	Diagrams: None
4	Permitted variants: Schedule 16, items 6, 9, 15, 28, 31, 34, 38 Same as diagram 2505
5	Illumination requirements: Schedule 17, item 4



2509.1  
Directions to several alternative parking places with an indication of the availability of parking spaces at each one (Variable message sign)

Item	
1	Regulations: 13(2), 13(7), 19(4), 24(1)
2	Directions: 13(3), 56
3	Diagrams: None
4	Permitted variants: Schedule 16, items 3, 6, 12, 16, 19, 28, 31, 34, 38 Same as diagram 2505. The right hand "P" symbol in the top panel may be omitted. The top panel or both "P" symbols in the top panel may be omitted and the "P" symbol added to each of the other panels. "Long stay" or "Short stay" may be added to or substituted for either "Town centre" in the top panel or the geographical names in the other panels. The legend "SPACES" may be varied to "NEARLY FULL" on one or two lines, "FULL" or "CLOSED". The legend "FULL" may be varied to "SPACES", "NEARLY FULL" on one or two lines or "CLOSED". The arrow may be omitted when all parking places indicated in that direction are shown as either "CLOSED" or "FULL". The legends "FULL", "CLOSED", "NEARLY FULL" and "SPACES" shall be displayed in red or green characters
5	Illumination requirements: Schedule 17, item 4

**Status:** This is the original version (as it was originally made). This item of legislation is currently only available in its original format.

SCHEDULE 7 PART VI DIRECTIONAL SIGNS TO PARKING PLACES (contd.)



2510  
Direction to a lorry park via a U-turn at a roundabout ahead

Item	
1	Regulations: 13(2), 13(7), 19(4), 24(1)
2	Directions: 13(3), 56
3	Diagrams: None
4	Permitted variants: Schedule 16, items 3, 6, 31, 34, 38 Same as diagram 2505. Where a symbol is directional it shall always face to the right. The lorry symbol may be omitted
5	Illumination requirements: Schedule 17, item 4



2511  
Direction to a secured car park approved by the police under the ACPO secured car park scheme

Item	
1	Regulations: 13(2), 13(7), 19(4), 24(1)
2	Directions: 13(3), 56
3	Diagrams: None
4	Permitted variants: Schedule 16, items 3, 6, 12, 28, 31, 34, 38 Same as diagram 2505. The "P" symbol and the "Secured" panel may be arranged in the manner shown in diagram 2512
5	Illumination requirements: Schedule 17, item 4



2512  
Same as diagram 2511

Item	
1	Regulations: 13(2), 13(7), 19(4), 24(1)
2	Directions: 13(3), 56
3	Diagrams: None
4	Permitted variants: Schedule 16, items 3, 6, 15, 28, 31, 34, 38 Same as diagram 2505. The "P" symbol and the "Secured" panel may be arranged in the manner shown in diagram 2511
5	Illumination requirements: Schedule 17, item 4



2513  
Double mini-roundabout ahead with exits to three different types of parking place

Item	
1	Regulations: 13(2), 13(7), 19(4), 24(1)
2	Directions: 13(3), 56
3	Diagrams: None
4	Permitted variants: Schedule 16, items 3, 6, 16, 18, 28, 31, 34, 38 Same as diagram 2505. The "P" symbols may be omitted and a panel added to the top of the sign in the manner shown in diagram 2509.1 with the legend varied as appropriate. The motor cycle symbol may be omitted
5	Illumination requirements: Schedule 17, item 4

**Status:** This is the original version (as it was originally made). This item of legislation is currently only available in its original format.

## PART VII

### DIRECTIONAL SIGNS FOR CYCLISTS AND PEDESTRIANS

#### SCHEDULE 7 PART VII DIRECTIONAL SIGNS FOR CYCLISTS AND PEDESTRIANS

Regulation 11(1)



2601.1  
Direction of a numbered route for pedal cycles forming part of a national cycle route network at a junction ahead

Item	
1	Regulations: None
2	Directions: 13(3)
3	Diagrams: None
4	Permitted variants: Schedule 16, items 3, 5, 12, 19, 20, 28, 34 The name of the cycle route may be added in the manner and size shown in diagram 2602.1. The background colour of the route number patch shall be varied to blue when the route forms part of a regional cycle route network. The pedestrian symbol shown in diagram 2605 may be added to the left of the route number when the cycle symbol faces to the right and to the right of the route number when the cycle symbol faces to the left. The arrow when pointing horizontally to the left or to the right may be placed at the bottom of the sign in the manner shown in diagram 2610.1
5	Illumination requirements: Schedule 17, item 9



2601.2  
Route for pedal cycles across an entry slip road at a junction ahead (Alternative types)

Item	
1	Regulations: None
2	Directions: 13(3), 18(1)
3	Diagrams: 1057
4	Permitted variants: Schedule 16, items 3, 5, 19
5	Illumination requirements: Schedule 17, item 9

**Status:** This is the original version (as it was originally made). This item of legislation is currently only available in its original format.

SCHEDULE 7 PART VII DIRECTIONAL SIGNS FOR CYCLISTS AND PEDESTRIANS (contd.)

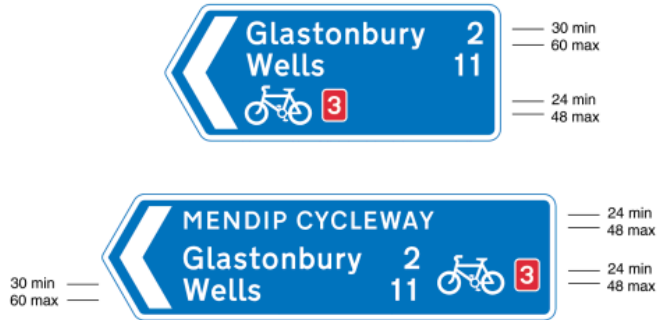

2602.1

Direction and distance to destinations shown along a numbered route for pedal cycles forming part of a national cycle route network (Alternative types)

Item	
1	Regulations: None
2	Directions: 13(3)
3	Diagrams: None
4	Permitted variants: Schedule 16, items 5, 9, 15, 19, 20, 28, 29, 34 The name of the cycle route may be added, varied or omitted as appropriate, and may be on more than one line. The background colour of the route number patch shall be varied to blue when the route forms part of a regional cycle route network. The pedestrian symbol shown in diagram 2605 may be added to the left of the route number when the cycle symbol faces to the right and to the right of the route number when the cycle symbol faces to the left
5	Illumination requirements: Schedule 17, item 9



2602.2  
Numbered route for pedal cycles forming part of a national cycle route network

Item	
1	Regulations: None
2	Directions: 13(3), 18(1)
3	Diagrams: 1057, 2610.2
4	Permitted variants: Schedule 16, item 20 The background colour of the route number patch shall be varied to blue when the route forms part of a regional cycle route network
5	Illumination requirements: Schedule 17, item 9



2602.3  
The number of a route for pedal cycles forming part of a regional cycle route network

Item	
1	Regulations: None
2	Directions: 13(3), 21(1)
3	Diagrams: 955, 956, 957
4	Permitted variants: Schedule 16, item 20 The background colour shall be varied to red when the route forms part of a national cycle route network
5	Illumination requirements: Schedule 17, item 8

**Status:** This is the original version (as it was originally made). This item of legislation is currently only available in its original format.

SCHEDULE 7 PART VII DIRECTIONAL SIGNS FOR CYCLISTS AND PEDESTRIANS (contd.)

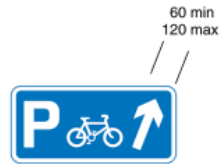

2603  
Junction ahead leading to a parking place for pedal cycles

Item	
1	Regulations: None
2	Directions: 13(3)
3	Diagrams: None
4	Permitted variants: Schedule 16, items 3, 6, 12, 28, 34 The word "Free" may be added. The name or location of the parking place may be added
5	Illumination requirements: Schedule 17, item 9



2604  
Direction and distance to a free parking place for pedal cycles

Item	
1	Regulations: None
2	Directions: 13(3)
3	Diagrams: None
4	Permitted variants: Schedule 16, items 6, 9, 15, 28, 34 The word "Free" may be omitted. The name or location of the parking place may be added
5	Illumination requirements: Schedule 17, item 9



2605  
Direction of route to destination shown for pedestrians

Item	
1	Regulations: None
2	Directions: 13(3)
3	Diagrams: None
4	Permitted variants: Schedule 16, items 3, 6, 15, 19, 28, 29, 34
5	Illumination requirements: Schedule 17, item 9



2606  
Direction of route to railway station for pedestrians and pedal cycles

Item	
1	Regulations: None
2	Directions: 13(3)
3	Diagrams: None
4	Permitted variants: Schedule 16, items 3, 6, 15, 19, 28, 34 When the sign points to the right, the pedestrian symbol with the cycle symbol to its immediate right shall be placed on the left hand side of the sign. The cycle or pedestrian symbol, but not both may be omitted
5	Illumination requirements: Schedule 17, item 9

**Status:** This is the original version (as it was originally made). This item of legislation is currently only available in its original format.

SCHEDULE 7 PART VII DIRECTIONAL SIGNS FOR CYCLISTS AND PEDESTRIANS (contd.)



2607  
Same as diagram 2605

Item	
1	Regulations: 13(2), 13(4), 13(7)
2	Directions: 13(3)
3	Diagrams: None
4	Permitted variants: Schedule 16, items 3, 6, 15, 19, 28, 29, 34 A border may be added. A chevron may be added. A symbol shown in Schedule 14 or other approved symbol with or without associated legend may be added. A logo or pictorial representation of a local landmark or historical feature may be added. The pedestrian symbol may be omitted. The legend, any symbol, logo, border or chevron and background may be in any contrasting colours. The shape of the end of the sign may be varied
5	Illumination requirements: Schedule 17, item 9



2608  
Direction of route to a tourist attraction for pedestrians

Item	
1	Regulations: None
2	Directions: 13(3)
3	Diagrams: None
4	Permitted variants: Schedule 16, items 3, 6, 15, 19, 28, 29, 33 The cycle symbol may be added to or substituted for the pedestrian symbol. A cycle route number patch may be added to the cycle symbol in the manner shown in diagram 2602.1. The wheelchair symbol shown in diagram 2311.1 may be added where the sign indicates facilities and the appropriate route for disabled people
5	Illumination requirements: Schedule 17, item 9



2609  
Direction of route for pedestrians to a parking place associated with a tourist attraction

Item	
1	Regulations: None
2	Directions: 13(3)
3	Diagrams: None
4	Permitted variants: Schedule 16, items 3, 6, 15, 28, 29 The name or location of the parking place may be added. The wheelchair symbol shown in diagram 2311.1 may be added where the sign indicates the appropriate route for disabled people
5	Illumination requirements: Schedule 17, item 9

**Status:** This is the original version (as it was originally made). This item of legislation is currently only available in its original format.

SCHEDULE 7 PART VII DIRECTIONAL SIGNS FOR CYCLISTS AND PEDESTRIANS (contd.)



35 min —  
70 max —  
CAPITAL  
LETTER  
HEIGHT

2610  
Direction to or along a public footpath

Item	
1	Regulations: 13(2), 13(4), 13(7)
2	Directions: 13(3), 42(1), 42(4)
3	Diagrams: None
4	Permitted variants: Schedule 16, items 3, 6, 15, 19, 28, 29 The border and chevron may be omitted. The background, border, symbol, chevron and legend may be in any contrasting colours except red. The walking figure symbol may be omitted or varied to the ridden horse symbol shown in diagram 622.6 or other appropriate symbol. The legend "Public Footpath" may be varied to "Footpath", "Bridleway", "Byway" or "Restricted Byway", or omitted. The name of the route may be added to or substituted for the legend "Public Footpath". An indication that a footpath over a level crossing is closed and the direction of the alternative route may be added
5	Illumination requirements: Schedule 17, item 9

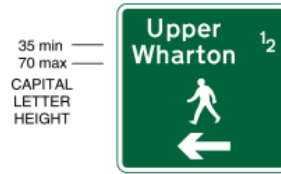

35 min —  
70 max —  
CAPITAL  
LETTER  
HEIGHT

2610.1  
Same as diagram 2610

Item	
1	Regulations: 13(2), 13(4), 13(7)
2	Directions: 13(3), 42(1), 42(4)
3	Diagrams: None
4	Permitted variants: Schedule 16, items 6, 9, 12, 19, 28 The border may be omitted. The background, border, symbol, arrow and legend may be in any contrasting colours except red. The walking figure symbol may be omitted or varied to the ridden horse symbol shown in diagram 622.6 or other appropriate symbol. The words "Public Footpath", "Footpath", "Bridleway", "Byway" or "Restricted Byway" may be added to or substituted for the destination. The name of the route may be added. An indication that a footpath over a level crossing is closed and the direction of the alternative route may be added
5	Illumination requirements: Schedule 17, item 9

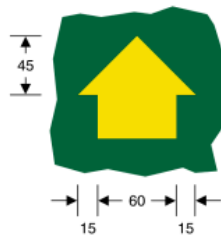

2610.2  
Direction along a footpath indicated by waymarks

Item	
1	Regulations: 13(2), 13(4), 13(7)
2	Directions: 13(3), 42(1), 42(4)
3	Diagrams: 2602.2
4	Permitted variants: Schedule 16, items 3, 6, 12 The colour of the arrow may be varied to blue to indicate bridleways, red to indicate byways or restricted byways, or white to indicate a route for pedal cycles. The legend "Public Footpath", "Footpath", "Bridleway", "Byway", "Restricted Byway", "Concessionary Path" or "Permissive Path" may be added as appropriate on or adjacent to the arrow. These legends may be in capital letters. The name of a destination or route or the identifying symbol of a route may be added on or adjacent to the arrow. The background and any legend may be in any contrasting colours
5	Illumination requirements: Schedule 17, item 9

**Status:** This is the original version (as it was originally made). This item of legislation is currently only available in its original format.

## PART VIII

### TEMPORARY AND EMERGENCY DIRECTIONAL SIGNS

#### SCHEDULE 7 PART VIII TEMPORARY AND EMERGENCY DIRECTIONAL SIGNS

Regulation 11(1)



2701  
Direction to a new housing development

Item	
1	Regulations: None
2	Directions: 13(3), 38(2)
3	Diagrams: None
4	Permitted variants: Schedule 16, items 3, 6, 15, 19, 29 The lorry symbol in diagram 804.1 may be added and reversed where appropriate
5	Illumination requirements: Schedule 17, item 9



2701.1  
Junction ahead leading to a new housing development

Item	
1	Regulations: None
2	Directions: 13(3), 38(2)
3	Diagrams: None
4	Permitted variants: Schedule 16, items 3, 6, 12, 19, 29 The U-turn arrow shown in diagram 2111.1 may be substituted for the horizontal arrow and shall always be on the right hand side of the sign. The lorry symbol in diagram 804.1 may be added and reversed where appropriate. The lorry symbol shall face to the right when the U-turn arrow is shown on the sign
5	Illumination requirements: Schedule 17, item 9

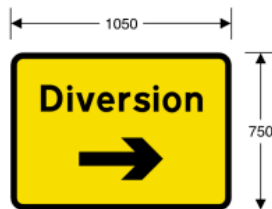

2702  
Start of temporary diversion route

Item	
1	Regulations: None
2	Directions: 13(3)
3	Diagrams: None
4	Permitted variants: Schedule 16, item 12 The arrow symbol may be replaced by the word "ENDS" or a distance in yards up to 400 yards to the nearest 10 yards
5	Illumination requirements: Schedule 17, item 4



2703  
Direction of temporary diversion route from junction ahead

Item	
1	Regulations: None
2	Directions: 13(3)
3	Diagrams: None
4	Permitted variants: Schedule 16, items 12, 20 Any symbol shown in Part VII of Schedule 13 may be substituted for "Diverted traffic". The U-turn arrow shown in diagram 2111.1 may be substituted for the horizontal arrow and shall always be on the right hand side of the sign
5	Illumination requirements: Schedule 17, item 4



**Status:** This is the original version (as it was originally made). This item of legislation is currently only available in its original format.

SCHEDULE 7 PART VIII TEMPORARY AND EMERGENCY DIRECTIONAL SIGNS (contd.)



2704  
Direction of temporary diversion route

Item	
1	Regulations: None
2	Directions: 13(3)
3	Diagrams: None
4	Permitted variants: Schedule 16, items 15, 20 Any symbol shown in Part VII of Schedule 13 may be substituted for "Diverted traffic"
5	Illumination requirements: Schedule 17, item 4



2705  
Junction ahead leading to temporary diversion routes to the destinations shown

Item	
1	Regulations: None
2	Directions: 13(3)
3	Diagrams: None
4	Permitted variants: Schedule 16, items 3, 5, 12, 16, 19, 20, 30, 31, 32, 34
5	Illumination requirements: Schedule 17, item 4



2706  
Roundabout ahead leading to a temporary diversion route to the destination shown

Item	
1	Regulations: None
2	Directions: 13(3)
3	Diagrams: None
4	Permitted variants: Schedule 16, items 3, 5, 16, 19, 20, 30, 31, 32, 34
5	Illumination requirements: Schedule 17, item 4



2707  
Direction of temporary diversion route to destination shown

Item	
1	Regulations: None
2	Directions: 13(3)
3	Diagrams: None
4	Permitted variants: Schedule 16, items 3, 5, 15, 19, 20, 30, 31, 32, 34
5	Illumination requirements: Schedule 17, item 4

**Status:** This is the original version (as it was originally made). This item of legislation is currently only available in its original format.

SCHEDULE 7 PART VIII TEMPORARY AND EMERGENCY DIRECTIONAL SIGNS (contd.)



2708  
Junction ahead leading to route for emergency vehicles to a temporary incident control point

Item	
1	Regulations: None
2	Directions: 13(3)
3	Diagrams: None
4	Permitted variants: Schedule 16, item 12 "EMERGENCY VEHICLES" may be varied to "INCIDENT CONTROL"
5	Illumination requirements: Schedule 17, item 4



2709  
Direction of route or junction ahead leading to a route for emergency vehicles to an emergency services incident point

Item	
1	Regulations: None
2	Directions: 13(3)
3	Diagrams: None
4	Permitted variants: Schedule 16, items 12, 19
5	Illumination requirements: Schedule 17, item 4



2710  
Same as diagram 2709

Item	
1	Regulations: None
2	Directions: 13(3)
3	Diagrams: None
4	Permitted variants: Schedule 16, items 15, 19
5	Illumination requirements: Schedule 17, item 4

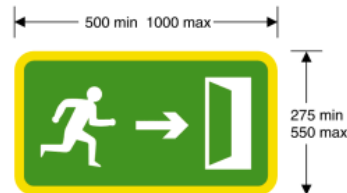

2711  
Direction to emergency exit for pedestrians from a tunnel

Item	
1	Regulations: None
2	Directions: None
3	Diagrams: None
4	Permitted variants: Schedule 16, items 13, 28 Symbols may be arranged vertically
5	Illumination requirements: Schedule 17, item 2

**Status:** This is the original version (as it was originally made). This item of legislation is currently only available in its original format.

SCHEDULE 7 PART VIII TEMPORARY AND EMERGENCY DIRECTIONAL SIGNS (contd.)

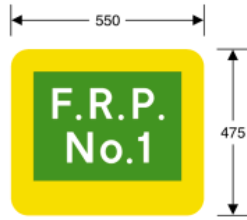

2712  
Location of fire rendezvous point

Item	
1	Regulations: None
2	Directions: 13(3)
3	Diagrams: None
4	Permitted variants: The legend "No. 1" may be varied to another number, a letter or a compass point. "F.R.P." may be varied to "R.V.P."
5	Illumination requirements: Schedule 17, item 9

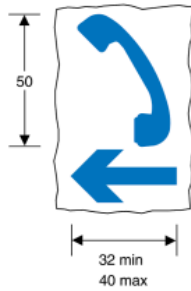

2713  
Direction to nearest emergency telephone on same side of the road

Item	
1	Regulations: None
2	Directions: 15(1)
3	Diagrams: 2714, 2715
4	Permitted variants: Schedule 16, item 13 The arrow and telephone symbol shall be coloured green when used on a primary route, and coloured black when used on a non-primary route
5	Illumination requirements: Schedule 17, item 9

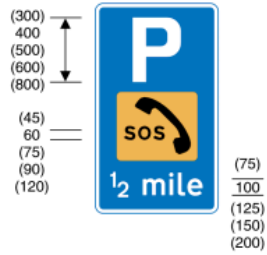

2713.1  
Distance ahead to emergency telephone in a parking place

Item	
1	Regulations: None
2	Directions: 13(3)
3	Diagrams: 642.3, 2714, 2715
4	Permitted variants: Schedule 16, items 6, 9, 11 The "P" symbol may be placed to the left of the orange panel or omitted
5	Illumination requirements: Schedule 17, item 4

*Status: This is the original version (as it was originally made). This item of legislation is currently only available in its original format.*

SCHEDULE 7 PART VIII TEMPORARY AND EMERGENCY DIRECTIONAL SIGNS (contd.)

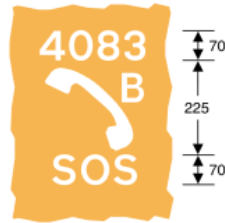

2714  
Side of emergency telephone box

Item	
1	Regulations: 13(8)
2	Directions: None
3	Diagrams: 642.3, 2713, 2713.1, 2715, 2717
4	Permitted variants: The identification number may be varied as appropriate. The colour of the legend and symbol may be varied to black. The relative position of the number and "SOS" may be reversed. A flashing white light may be added to the sign
5	Illumination requirements: Schedule 17, item 15



2715  
Back of emergency telephone box

Item	
1	Regulations: 13(8)
2	Directions: None
3	Diagrams: 642.3, 2713, 2713.1, 2714, 2717
4	Permitted variants: Same as diagram 2714
5	Illumination requirements: Schedule 17, item 15



2716  
Junction ahead leading to a temporary diversion route, the direction along which is indicated by a symbol shown in Part VII of Schedule 13

Item	
1	Regulations: None
2	Directions: None
3	Diagrams: None
4	Permitted variants: Schedule 16, items 12, 14, 19, 20 "M1 North" may be varied to the name of a road, to a route number and a place name, or to a description of a route. "closed" may be varied to "closed to" and a type of vehicle or road user. The upper part of the sign may be omitted. "Alternative route" may be varied to "To rejoin", or to "To rejoin" and a route number. "to" and a destination may be added after "Alternative route". The diversion symbol may be varied to any of those shown in Part VII of Schedule 13, to any combination of place names and route numbers, to a description of a route or to the name of a road. "follow" may be varied to "use" or "via" as appropriate
5	Illumination requirements: Schedule 17, item 4

**Status:** This is the original version (as it was originally made). This item of legislation is currently only available in its original format.

SCHEDULE 7 PART VIII TEMPORARY AND EMERGENCY DIRECTIONAL SIGNS (contd.)

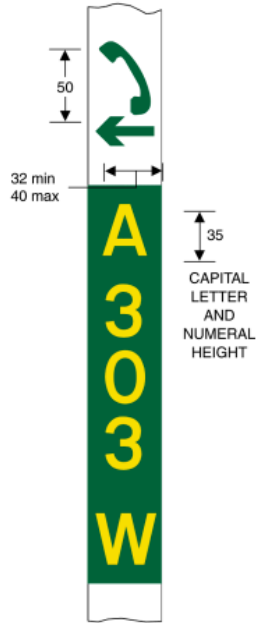

2717  
Location on a primary route given by route number and direction of travel, and direction of nearest emergency telephone

Item	
1	Regulations: None
2	Directions: 12(1)
3	Diagrams: 2714, 2715
4	Permitted variants: Schedule 16, item 13 The route number and abbreviated compass point may be varied as appropriate
5	Illumination requirements: Schedule 17, item 9

*Status: This is the original version (as it was originally made). This item of legislation is currently only available in its original format.*

## PART IX

### OTHER NON-MOTORWAY DIRECTIONAL SIGNS

#### SCHEDULE 7 PART IX OTHER NON-MOTORWAY DIRECTIONAL SIGNS

Regulation 11(1)

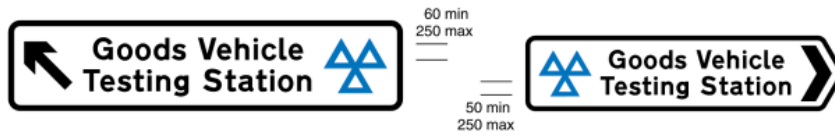

2801  
Junction ahead leading to Vehicle Inspectorate testing station for goods vehicles

Item	
1	Regulations: None
2	Directions: 13(3)
3	Diagrams: None
4	Permitted variants: Schedule 16, items 3, 6, 12, 29 The word "Goods" may be omitted or varied as appropriate to indicate the type or types of vehicle tested. The inclined arrow may be omitted and the U-turn arrow shown in diagram 2111.1 added to the right of the legend, with the associated symbol placed to the left of the legend. The testing station symbol may be omitted
5	Illumination requirements: Schedule 17, item 9

2802  
Direction to Vehicle Inspectorate testing station for goods vehicles

Item	
1	Regulations: None
2	Directions: 13(3)
3	Diagrams: None
4	Permitted variants: Schedule 16, items 3, 6, 15, 29 The word "Goods" may be omitted or varied as appropriate to indicate the type or types of vehicle tested. The testing station symbol may be omitted
5	Illumination requirements: Schedule 17, item 9



2803  
Junction ahead leading to routes to Ministry of Defence establishments

Item	
1	Regulations: None
2	Directions: 13(3)
3	Diagrams: None
4	Permitted variants: Schedule 16, items 3, 5, 12, 16, 19 Where the sign displays only one directional panel, the horizontal arrow may be omitted and the U-turn arrow shown in diagram 2111.1 added to the right of the legend. The U-turn arrow shall be coloured red
5	Illumination requirements: Schedule 17, item 4

2804  
Direction to a Ministry of Defence establishment

Item	
1	Regulations: None
2	Directions: 13(3)
3	Diagrams: None
4	Permitted variants: Schedule 16, items 3, 5, 15, 19
5	Illumination requirements: Schedule 17, item 4

**Status:** This is the original version (as it was originally made). This item of legislation is currently only available in its original format.

SCHEDULE 7 PART IX OTHER NON-MOTORWAY DIRECTIONAL SIGNS (contd.)



2805

Junction ahead leading to route advised for goods vehicles, which may differ from that for other traffic (Alternative types)

Item	
1	Regulations: None
2	Directions: 13(3)
3	Diagrams: None
4	Permitted variants: Schedule 16, items 3, 5, 12, 16, 19, 20, 21, 22, 28, 32 Non-primary route numbers shall be shown in white characters on the black background. Where the sign displays only one directional panel, the horizontal arrow may be omitted and the U-turn arrow shown in diagram 2035 added to the right hand side of the sign; the lorry symbol shall always face to the right
5	Illumination requirements: Schedule 17, item 4

2806

Direction to destination shown of route advised for goods vehicles, which may differ from that for other traffic

Item	
1	Regulations: None
2	Directions: 13(3)
3	Diagrams: None
4	Permitted variants: Schedule 16, items 3, 5, 15, 19, 20, 21, 22, 28, 32. Route numbers where added shall be shown in the same manner as for diagram 2805
5	Illumination requirements: Schedule 17, item 4



2806.1

Route to be followed at junction ahead for a destination along a route advised for goods vehicles that is not otherwise shown on signs for that junction

Item	
1	Regulations: None
2	Directions: 13(3)
3	Diagrams: None
4	Permitted variants: Schedule 16, items 19, 20, 21 "follow" and the route number may be varied to "leave at next junction" or "leave at" and the name of the junction
5	Illumination requirements: Schedule 17, item 4

*Status: This is the original version (as it was originally made). This item of legislation is currently only available in its original format.*

## PART X MOTORWAY SIGNS

### SCHEDULE 7 PART X MOTORWAY SIGNS

Regulation 11(1)



2901  
Regulations in force under section 17 of the 1984 Act start to apply to the road at this point

Item	
1	Regulations: None
2	Directions: 14(1)
3	Diagrams: None
4	Permitted variants: Schedule 16, item 20
5	Illumination requirements: Schedule 17, item 1



2902  
Direction to a motorway at the junction shown, indicating route number and destination reached along the motorway

Item	
1	Regulations: None
2	Directions: 14(2)
3	Diagrams: None
4	Permitted variants: Schedule 16, items 15, 19, 20, 29, 30 The motorway regulations symbol shall be omitted and the letters and numerals in Part I of Schedule 13 used for the motorway route number where that part of the junction leads indirectly to the motorway
5	Illumination requirements: Schedule 17, item 1



2902.1  
Direction to a motorway at the junction shown, indicating route number

Item	
1	Regulations: None
2	Directions: 14(2)
3	Diagrams: None
4	Permitted variants: Schedule 16, items 12, 20
5	Illumination requirements: Schedule 17, item 1



2903  
Motorway junction ahead, identified by the number shown on a black background, leading to the destination and route shown. The number of lanes on the motorway remains the same through the junction

Item	
1	Regulations: None
2	Directions: 14(1)
3	Diagrams: None
4	Permitted variants: Schedule 16, items 7, 19, 20, 30, 34
5	Illumination requirements: Schedule 17, item 4



**Status:** This is the original version (as it was originally made). This item of legislation is currently only available in its original format.

SCHEDULE 7 PART X MOTORWAY SIGNS (contd.)

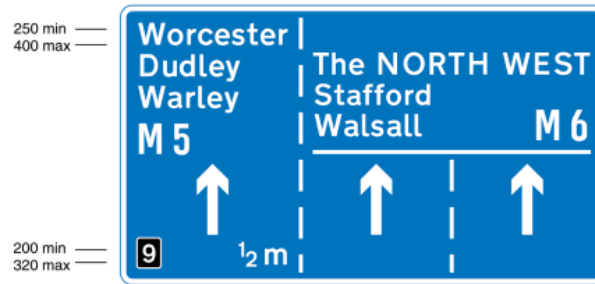

2904  
Motorway junction ahead, identified by the number shown on a black background, where the left hand lane of a motorway leads to another motorway and the other two lanes continue along the main motorway route

Item	
1	Regulations: 13(5)
2	Directions: 14(1)
3	Diagrams: None
4	Permitted variants: Schedule 16, items 7, 16, 19, 20, 30, 34
5	Illumination requirements: Schedule 17, item 4



2904.1  
Motorway junction, identified by the number shown on a black background, where the left hand lane of a motorway leads to another motorway and the other two lanes continue along the main motorway route

Item	
1	Regulations: 13(5)
2	Directions: 14(1)
3	Diagrams: None
4	Permitted variants: Schedule 16, items 16, 19, 20, 30, 34
5	Illumination requirements: Schedule 17, item 4

**Status:** This is the original version (as it was originally made). This item of legislation is currently only available in its original format.

SCHEDULE 7 PART X MOTORWAY SIGNS (contd.)

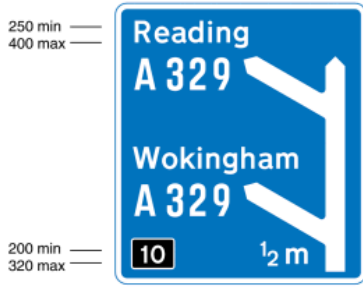

2905  
Two motorway junctions ahead in quick succession, identified by the number shown on a black background, leading to the destinations and routes shown. The number of lanes on the motorway remains the same through the junction

Item	
1	Regulations: None
2	Directions: 14(1)
3	Diagrams: None
4	Permitted variants: Schedule 16, items 7, 19, 20, 30, 34 The number of the second exit may be shown on a black background below the appropriate route number. The distance in miles to the second exit may be shown in a manner similar to the distance shown to the first exit
5	Illumination requirements: Schedule 17, item 4

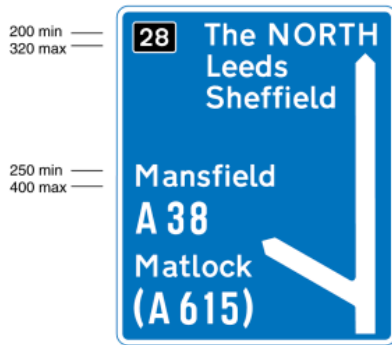

2906  
Motorway junction, identified by the number shown on a black background, leading to the destinations and routes shown and with an indication of the destinations reached by remaining on the motorway. The number of lanes on the motorway remains the same through the junction

Item	
1	Regulations: 13(5)
2	Directions: 14(1)
3	Diagrams: None
4	Permitted variants: Schedule 16, items 7, 19, 20, 30, 34
5	Illumination requirements: Schedule 17, item 4

**Status:** This is the original version (as it was originally made). This item of legislation is currently only available in its original format.

SCHEDULE 7 PART X MOTORWAY SIGNS (contd.)



2908  
Motorway junction ahead, identified by the number shown on a black background, leading to the destinations and routes shown and with an indication of the destinations reached by remaining on the motorway. The number of lanes on the motorway remains the same through the junction (Gantry-mounted sign)

Item	
1	Regulations: 13(5)
2	Directions: 14(1)
3	Diagrams: None
4	Permitted variants: Schedule 16, items 7, 9, 12, 19, 20, 30, 34
5	Illumination requirements: Schedule 17, item 1

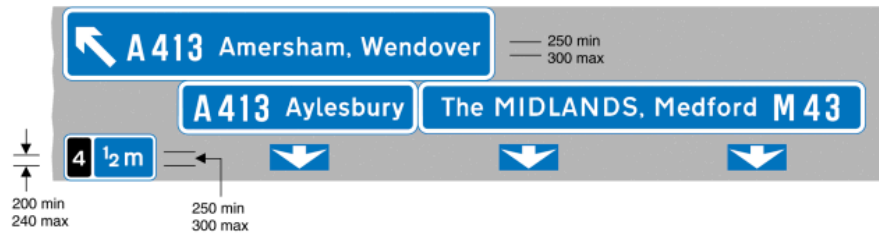

2908.1  
Two motorway exits ahead in quick succession, identified by the junction number shown on a black background, leading to the destinations and routes shown. The number of lanes remains the same through the first exit. At the second exit the left hand lane leads to the route and destination shown over that lane on the lower part of the sign and the other two lanes continue along the main motorway route (Gantry-mounted sign)

Item	
1	Regulations: 13(5)
2	Directions: 14(1)
3	Diagrams: None
4	Permitted variants: Schedule 16, items 7, 9, 16, 19, 20, 30, 34 The number of the first exit may be shown on a black background to the bottom left of the arrow in the upper sign panel. The distance in miles to the first exit may be shown to the bottom left of the arrow and to the right of any junction number in the upper sign panel
5	Illumination requirements: Schedule 17, item 1

**Status:** This is the original version (as it was originally made). This item of legislation is currently only available in its original format.

SCHEDULE 7 PART X MOTORWAY SIGNS (contd.)

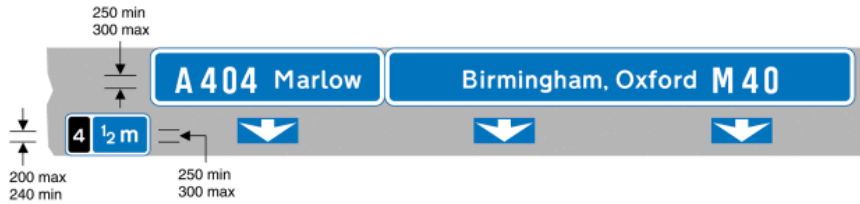

2909  
Motorway junction ahead, or directions at motorway junction when distance omitted, identified by the number shown on a black background, where the left hand lane leads to the route and destination shown and the other two lanes continue along the main motorway route to the destinations shown (Gantry-mounted sign)

Item	
1	Regulations: 13(5)
2	Directions: 14(1)
3	Diagrams: None
4	Permitted variants: Schedule 16, items 7, 9, 16, 19, 20, 30, 34
5	Illumination requirements: Schedule 17, item 1



2910  
Number of route reached from a motorway exit road

Item	
1	Regulations: None
2	Directions: 14(1)
3	Diagrams: None
4	Permitted variants: Schedule 16, item 20 The word "Services" may be added below the route number
5	Illumination requirements: Schedule 17, item 4



2910.1  
Same as diagram 2910

Item	
1	Regulations: None
2	Directions: 14(1)
3	Diagrams: None
4	Permitted variants: Schedule 16, item 20 Same as diagram 2910
5	Illumination requirements: Schedule 17, item 4

**Status:** This is the original version (as it was originally made). This item of legislation is currently only available in its original format.

SCHEDULE 7 PART X MOTORWAY SIGNS (contd.)



— 250 min  
— 400 max



— 250 min  
— 400 max

2911

Route number of the motorway with destinations and distances to places along or reached from that route

Item	
1	Regulations: None
2	Directions: 14(1)
3	Diagrams: None
4	Permitted variants: Schedule 16, items 4, 19, 20, 30
5	Illumination requirements: Schedule 17, item 4

2912

Junction ahead with another motorway

Item	
1	Regulations: None
2	Directions: 14(1)
3	Diagrams: None
4	Permitted variants: Schedule 16, items 4, 20 The junction number may be added after the word "Junction"
5	Illumination requirements: Schedule 17, item 4



— 150 min  
— 300 max

2913

Roundabout ahead leading from a motorway exit slip road to a primary and a non-primary route

Item	
1	Regulations: 13(5)
2	Directions: 14(1)
3	Diagrams: None
4	Permitted variants: Schedule 16, items 16, 18, 19, 20, 21, 22, 23, 24, 25, 26, 30, 31, 32, 34
5	Illumination requirements: Schedule 17, item 4

**Status:** This is the original version (as it was originally made). This item of legislation is currently only available in its original format.

SCHEDULE 7 PART X MOTORWAY SIGNS (contd.)



2913.1 Roundabout ahead leading from a motorway exit slip road to another motorway

Item	
1	Regulations: 13(5)
2	Directions: 14(1)
3	Diagrams: None
4	Permitted variants: Schedule 16, items 16, 19, 20, 30, 34 and where the sign indicates additionally a route other than a motorway, items 18, 21, 22, 23, 24, 25, 26, 31, 32
5	Illumination requirements: Schedule 17, item 4

2913.2 Junction ahead leading from a motorway exit slip road to a primary and a non-primary route

Item	
1	Regulations: 13(5)
2	Directions: 14(1)
3	Diagrams: None
4	Permitted variants: Schedule 16, items 12, 16, 19, 20, 21, 22, 23, 24, 25, 26, 30, 31, 32, 34
5	Illumination requirements: Schedule 17, item 4



2913.3 The two left hand lanes of a motorway exit slip road lead to a primary route and the right hand lane leads to a non-primary route at a junction ahead

Item	
1	Regulations: 13(5)
2	Directions: 14(1)
3	Diagrams: None
4	Permitted variants: Schedule 16, items 16, 19, 20, 21, 22, 23, 24, 25, 26, 30, 31, 32, 34
5	Illumination requirements: Schedule 17, item 4

**Status:** This is the original version (as it was originally made). This item of legislation is currently only available in its original format.

SCHEDULE 7 PART X MOTORWAY SIGNS (contd.)



2913.4  
Same as diagram 2913.3  
(Gantry-mounted sign)

Item	
1	Regulations: 13(5)
2	Directions: 14(1)
3	Diagrams: None
4	Permitted variants: Schedule 16, items 16, 19, 20, 21, 22, 23, 30, 34
5	Illumination requirements: Schedule 17, item 1

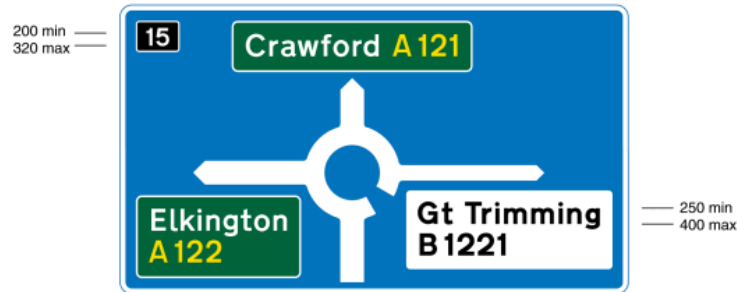

2914  
Termination of a motorway at a roundabout ahead  
leading to two primary routes and a non-primary route

Item	
1	Regulations: 13(5)
2	Directions: 14(1)
3	Diagrams: None
4	Permitted variants: Schedule 16, items 7, 16, 18, 19, 20, 21, 22, 23, 24, 25, 26, 30, 31, 32, 34
5	Illumination requirements: Schedule 17, item 4

**Status:** This is the original version (as it was originally made). This item of legislation is currently only available in its original format.

SCHEDULE 7 PART X MOTORWAY SIGNS (contd.)



2914.1

Termination of the main carriageway of a motorway at a roundabout ahead leading to another motorway

Item	
1	Regulations: 13(5)
2	Directions: 14(1)
3	Diagrams: None
4	Permitted variants: Schedule 16, items 7, 16, 19, 20, 30, 34 and where the sign indicates additionally a route other than a motorway, items 18, 21, 22, 23, 24, 25, 26, 31, 32
5	Illumination requirements: Schedule 17, item 4

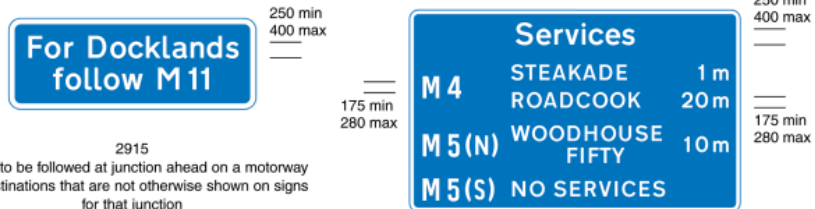

2915

Route to be followed at junction ahead on a motorway for destinations that are not otherwise shown on signs for that junction

2917

Availability of motorway service areas ahead with distances and names of operators

Item	
1	Regulations: 13(5)
2	Directions: 14(1)
3	Diagrams: None
4	Permitted variants: Schedule 16, items 19, 20, 30, 34 The legend "Park and Ride" may be added after "Docklands". A place name may be added to or substituted for the route number. "follow" and the route number may be varied to "leave at next junction", "leave at Junction" and the junction number, or "use" and a route number "at Junction" and the junction number. "Junction" may be varied to "J"
5	Illumination requirements: Schedule 17, item 4

Item	
1	Regulations: None
2	Directions: 14(1)
3	Diagrams: None
4	Permitted variants: Schedule 16, items 4, 20 The names of the service area operators and the words "NO SERVICES" may be varied or omitted as appropriate. "1 m" may be varied to "2/3 m"
5	Illumination requirements: Schedule 17, item 4



**Status:** This is the original version (as it was originally made). This item of legislation is currently only available in its original format.

SCHEDULE 7 PART X MOTORWAY SIGNS (contd.)



2918  
Distance to next motorway service area

Item	
1	Regulations: None
2	Directions: 14(1)
3	Diagrams: None
4	Permitted variants: Schedule 16, item 4
5	Illumination requirements: Schedule 17, item 4



2918.1  
Services are not available on motorway

Item	
1	Regulations: None
2	Directions: 14(1)
3	Diagrams: None
4	Permitted variants: None
5	Illumination requirements: Schedule 17, item 4



2919.1  
Distance ahead to a named motorway service area at which fuel, parking, toilets and facilities for disabled persons are available, and refreshments, overnight accommodation, LPG fuel and a Tourist Information Point or Centre may be available, 24 hours a day throughout the year, and showing the name of the operator and the price per litre of unleaded petrol

Item	
1	Regulations: 13(2), 13(4), 13(7)
2	Directions: 14(1)
3	Diagrams: None
4	Permitted variants: Schedule 16, item 8 The name of the operator may be varied. The operator's logo may be shown in the upper panel. The legend, logo, background and border of the upper panel may be in any contrasting colours. The upper panel border may be omitted. The upper panel may be omitted. "Puddleworth" shall be varied to another geographical name as appropriate. The LPG fuel, "i" and bed symbols may be omitted as appropriate. The petrol price where shown shall accord with that currently being charged for 1 litre of unleaded petrol. The petrol price row may be omitted and the white petrol pump symbol shown in diagram 2310.1 added at the beginning of the top row of symbols
5	Illumination requirements: Schedule 17, item 4

**Status:** This is the original version (as it was originally made). This item of legislation is currently only available in its original format.

SCHEDULE 7 PART X MOTORWAY SIGNS (contd.)



2920.1  
Direction to a named motorway service area and showing the name of the operator

Item	
1	Regulations: 13(2), 13(4), 13(7)
2	Directions: 14(1)
3	Diagrams: None
4	Permitted variants: Schedule 16, item 12 Same as diagram 2919.1 in respect of the upper panel and the geographical name on the lower panel
5	Illumination requirements: Schedule 17, item 4



2921  
Entrance to motorway service area

Item	
1	Regulations: None
2	Directions: 14(1)
3	Diagrams: None
4	Permitted variants: Schedule 16, item 15
5	Illumination requirements: Schedule 17, item 4



2921.1  
Same as diagram 2921 or direction to a motorway service area at a junction ahead on a motorway slip road

Item	
1	Regulations: None
2	Directions: 14(1)
3	Diagrams: None
4	Permitted variants: Schedule 16, item 12
5	Illumination requirements: Schedule 17, item 4



2922  
Entrance for works traffic only

Item	
1	Regulations: None
2	Directions: 14(1)
3	Diagrams: None
4	Permitted variants: None
5	Illumination requirements: Schedule 17, item 4

**Status:** This is the original version (as it was originally made). This item of legislation is currently only available in its original format.

SCHEDULE 7 PART X MOTORWAY SIGNS (contd.)



250 min  
300 max

2924  
Motorway junction ahead leading to the tourist attractions shown

Item	
1	Regulations: None
2	Directions: 14(1)
3	Diagrams: None
4	Permitted variants: Schedule 16, items 12, 16, 19, 29, 33 When the arrow is pointing vertically upwards it may be placed on the right hand side of the sign with the symbols placed on the left hand side and reversed as appropriate
5	Illumination requirements: Schedule 17, item 4



150 min  
300 max

2925  
Roundabout ahead leading from a motorway exit slip road to the tourist attractions shown

Item	
1	Regulations: None
2	Directions: 14(1)
3	Diagrams: None
4	Permitted variants: Schedule 16, items 3, 5, 16, 18, 19, 31, 32, 33
5	Illumination requirements: Schedule 17, item 4

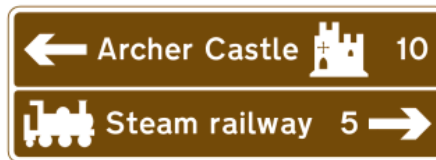

150 min  
300 max

2926  
Junction ahead from a motorway exit slip road to the tourist attractions shown

Item	
1	Regulations: None
2	Directions: 14(1)
3	Diagrams: None
4	Permitted variants: Schedule 16, items 5, 12, 16, 19, 29, 31, 32, 33
5	Illumination requirements: Schedule 17, item 4

**Status:** This is the original version (as it was originally made). This item of legislation is currently only available in its original format.

SCHEDULE 7 PART X MOTORWAY SIGNS (contd.)

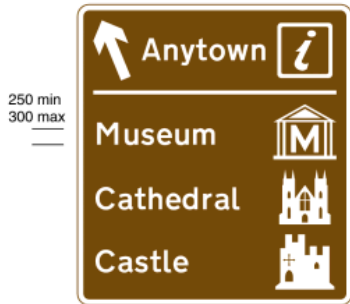

250 min  
300 max

Item	
1	Regulations: None
2	Directions: 14(1)
3	Diagrams: None
4	Permitted variants: Schedule 16, items 12, 19, 33 The number of tourist attractions shown on the lower part of the sign may be varied, but shall not exceed three
5	Illumination requirements: Schedule 17, item 4

2927

Motorway junction ahead leading to a town or geographical area containing a Tourist Information Point or Centre and several tourist attractions



250 min  
300 max

200 min  
300 max



2928

- (a) Boundary of the area of a county council in England; or
- (b) boundary of the area of a council in Scotland; or
- (c) boundary of the area of a county or county borough council in Wales

2927.1

Exit from a motorway at a junction ahead that should be used for a tourist attraction that is not otherwise shown on signs on the main carriageway of the motorway at that junction

Item	
1	Regulations: 13(5)
2	Directions: 14(1)
3	Diagrams: None
4	Permitted variants: Schedule 16, items 19, 20, 33 "leave at Junction" and the junction number may be varied to "follow" and a place name, a route number, or a place name and a route number. "leave" may be varied to "use" and a route number. "leave at Junction" and the junction number may be varied to "leave at next junction". "Junction" may be varied to "J". Route numbers shall be shown in white characters on the brown background
5	Illumination requirements: Schedule 17, item 4

Item	
1	Regulations: None
2	Directions: 14(1)
3	Diagrams: None
4	Permitted variants: Schedule 16, item 19 A crest or logo and either a message of welcome or a phrase denoting an item of local geographical or historical interest, not exceeding three words in either case, may be added. The name of the county may be varied to the name of a river or inland waterway. The background colour may be white with black letters and border
5	Illumination requirements: Schedule 17, item 4

**Status:** This is the original version (as it was originally made). This item of legislation is currently only available in its original format.

SCHEDULE 7 PART X MOTORWAY SIGNS (contd.)



2929  
Motorway junction ahead leading to a route advised for goods vehicles to the destination shown, which may differ from that for other traffic

Item	
1	Regulations: 13(5)
2	Directions: 14(1)
3	Diagrams: None
4	Permitted variants: Schedule 16, items 12, 16, 19, 20, 28 and when placed on a motorway exit slip road, items 3, 5, 21, 22, 32 Route numbers shall be shown in white characters on the black background when the sign is placed on the main carriageway of the motorway. The relative positions of the arrow and symbol and other legend may be reversed. The vertical arrow may be placed on the right hand side of the sign and the lorry symbol reversed
5	Illumination requirements: Schedule 17, item 4



2929.1  
Exit from a motorway at a junction ahead that should be used for a destination along a route advised for goods vehicles that is not otherwise shown on signs on the main carriageway of the motorway at that junction

Item	
1	Regulations: 13(5)
2	Directions: 14(1)
3	Diagrams: None
4	Permitted variants: Schedule 16, items 19, 20 "leave at Junction" and the junction number may be varied to "follow" and a place name, a route number, or a place name and a route number. "leave" may be varied to "use" and a route number. "leave at Junction" and the junction number may be varied to "leave at next junction". "Junction" may be varied to "J". Route numbers shall be shown in white characters on the black background
5	Illumination requirements: Schedule 17, item 4

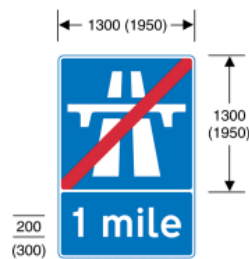

2930  
Regulations referred to in the caption under diagram 2901 cease to apply ahead

Item	
1	Regulations: None
2	Directions: 14(1)
3	Diagrams: None
4	Permitted variants: "1 mile" may be varied to "1/2 mile"
5	Illumination requirements: Schedule 17, item 1

**Status:** This is the original version (as it was originally made). This item of legislation is currently only available in its original format.

SCHEDULE 7 PART X MOTORWAY SIGNS (contd.)

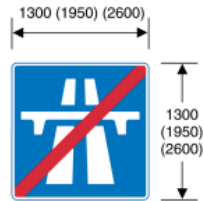

2931  
Regulations referred to in the caption under diagram 2901 cease to apply at this point

Item	
1	Regulations: None
2	Directions: 14(1)
3	Diagrams: None
4	Permitted variants: None
5	Illumination requirements: Schedule 17, item 1



2932  
Entrance to motorway service area, maintenance compound or similar facility contained within the length of a motorway and indicating that the Regulations referred to in the caption under diagram 2901 cease to apply at this point

Item	
1	Regulations: None
2	Directions: 14(1)
3	Diagrams: None
4	Permitted variants: None
5	Illumination requirements: Schedule 17, item 4



2933  
Drivers should keep a distance of two chevron markings from the vehicle in front

Item	
1	Regulations: None
2	Directions: 14(1), 17, 18(1)
3	Diagrams: 1064, 2934
4	Permitted variants: None
5	Illumination requirements: Schedule 17, item 4



2934  
Drivers should check their distance from the vehicle in front

Item	
1	Regulations: None
2	Directions: 14(1), 17, 18(1)
3	Diagrams: 1064, 2933
4	Permitted variants: "Check" may be varied to "Keep"
5	Illumination requirements: Schedule 17, item 4

**Status:** This is the original version (as it was originally made). This item of legislation is currently only available in its original format.

## SCHEDULE 8

### LIGHT SIGNALS FOR THE CONTROL OF VEHICULAR TRAFFIC

#### SCHEDULE 8 LIGHT SIGNALS FOR THE CONTROL OF VEHICULAR TRAFFIC

Regulations  
33, 34, 35, 39, 41

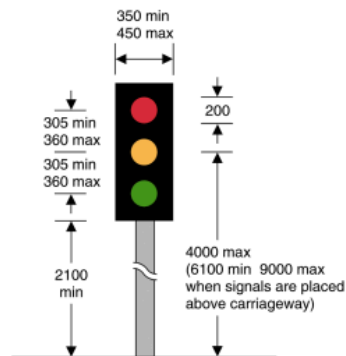

Item	
1	Regulations: 10(1), 10(2), 33, 36
2	Directions: 18(1), 18(2), 21(1), 46, 47, 55, 56
3	Diagrams: 543.1, 1001, 1001.2, 1055.1, 1055.2
4	Permitted variants: None

3000  
Light signals for the control of vehicular traffic at road junctions, at signal-controlled crossing facilities, or at places where the headroom or width of the road is permanently reduced

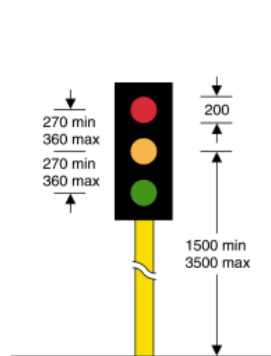

3000.1  
Portable light signals

Item	
1	Regulations: 10(1), 10(2), 35, 36
2	Directions: 18(1), 46, 53, 56
3	Diagrams: 1001, 7011, 7011.1, 7027, 7028
4	Permitted variants: None

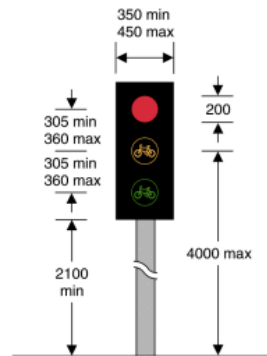

3000.2  
Light signals for the control of vehicular traffic consisting solely of pedal cycles

Item	
1	Regulations: 10(1), 10(2), 33, 36
2	Directions: 18(1), 46, 47, 55(7), 56
3	Diagrams: 1001, 1055.1, 1055.2
4	Permitted variants: None

**Status:** This is the original version (as it was originally made). This item of legislation is currently only available in its original format.

SCHEDULE 8 LIGHT SIGNALS FOR THE CONTROL OF VEHICULAR TRAFFIC (contd.)

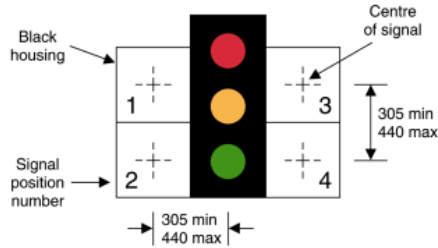

3000.7  
 As for diagram 3000 with additional signals as shown in diagram 3001.2, 3001.3 or 3013 placed in any of the positions marked "1", "2", "3" and "4" in accordance with the table of combinations below  
 (Position numbers and centre marks do not form part of the signal)

Item	
1	Regulations: 10(1), 10(2), 33, 34, 36, 41(3)
2	Directions: 18(1), 18(2), 21(1), 46, 47, 55, 56
3	Diagrams: 543.1, 1001, 1001.2, 1055.1, 1055.2
4	Permitted variants: Where a signal shown in diagram 3001.2, 3001.3 or 3013 is not placed in one of the marked positions, the housing for that signal shall be omitted

Table of combinations

Item 1	Signal position	1	2	3	4
Item 2	Signal combinations	None	3001.2 (A, B or C); or 3001.3 (A, B or C); or 3013	None	None
		None	None	None	3001.2 (C, D or E); or 3001.3 (C, D or E); or 3013
		3013	3001.2 (A, B or C); or 3001.3 (A, B or C)	None	None
		None	None	3013	3001.2 (C, D or E); or 3001.3 (C, D or E)
		3001.2 (B or C); or 3001.3 (B or C)	3001.2 (A); or 3001.3 (A)	None	None
		3001.2 (C); or 3001.3 (C)	3001.2 (A or B); or 3001.3 (A or B)	None	None
		None	None	3001.2 (C or D); or 3001.3 (C or D)	3001.2 (E); or 3001.3 (E)
		None	None	3001.2 (C); or 3001.3 (C)	3001.2 (D or E); or 3001.3 (D or E)
		None	3013	None	None
None	None	None	3013		



**Status:** This is the original version (as it was originally made). This item of legislation is currently only available in its original format.

SCHEDULE 8 LIGHT SIGNALS FOR THE CONTROL OF VEHICULAR TRAFFIC (contd.)

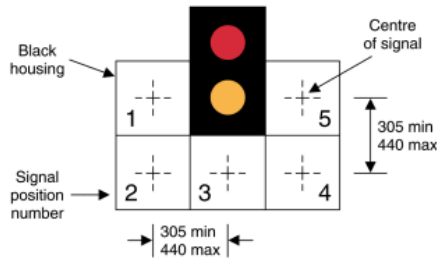

3000.8

As for diagram 3000, but without the green aspect and with additional signals as shown in diagram 3001.2, 3001.3 or 3013 placed in any of the positions marked "1", "2", "3", "4" and "5" in accordance with the table of combinations below (Position numbers and centre marks do not form part of the signal)

Item	
1	Regulations: 10(1), 10(2), 33, 34, 36, 41(3)
2	Directions: 18(1), 18(2), 21(1), 46, 47, 55, 56
3	Diagrams: 543.1, 1001, 1001.2, 1055.1, 1055.2
4	Permitted variants: Where a signal shown in diagram 3001.2, 3001.3 or 3013 is not placed in one of the marked positions, the housing for that signal shall be omitted

Table of combinations

Item 1	Signal position	1	2	3	4	5
Item 2	Signal combinations	None	3013; or none	3001.2; or 3001.3	None	None
		None	None	3001.2; or 3001.3	3013; or none	None
		3013; or none	3001.2 (A, B or C); or 3001.3 (A, B or C)	3001.2 (D or E); or 3001.3 (D or E)	None	None
		3013; or none	3001.2 (A or B); or 3001.3 (A or B)	3001.2 (C, D or E); or 3001.3 (C, D or E)	None	None
		None	None	3001.2 (A, B or C); or 3001.3 (A, B or C)	3001.2 (D or E); or 3001.3 (D or E)	3013; or none
		None	None	3001.2 (A or B); or 3001.3 (A or B)	3001.2 (C, D or E); or 3001.3 (C, D or E)	3013; or none

**Status:** This is the original version (as it was originally made). This item of legislation is currently only available in its original format.

SCHEDULE 8 LIGHT SIGNALS FOR THE CONTROL OF VEHICULAR TRAFFIC (contd.)

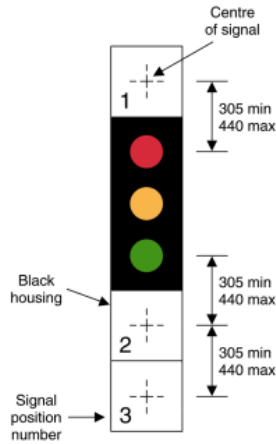

3000.9

As for diagram 3000 with additional signals as shown in diagram 3001.2, 3001.3 or 3013 placed in any of the positions marked "1", "2" and "3" in accordance with the table of combinations below (Position numbers and centre marks do not form part of the signal)

Item	
1	Regulations: 10(1), 10(2), 33, 34, 36, 41(3)
2	Directions: 18(1), 18(2), 21(1), 46, 47, 55, 56
3	Diagrams: 543.1, 1001, 1001.2, 1055.1, 1055.2
4	Permitted variants: Where a signal shown in diagram 3001.2, 3001.3 or 3013 is not placed in one of the marked positions, the housing for that signal shall be omitted

Table of combinations

Item 1	Signal position	1	2	3
Item 2	Signal combinations	3013	None	None
		None	3001.2; or 3001.3	3001.2; or 3001.3; or none
		None	3013	None
		None	3001.2; or 3001.3	3013; or none

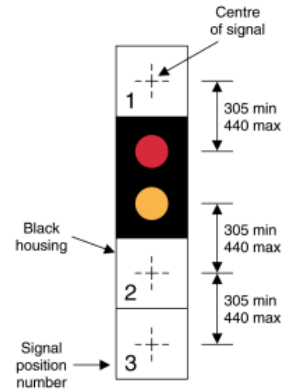

3000.10

As for diagram 3000, but without the green aspect and with additional signals as shown in diagram 3001.2, 3001.3 or 3013 placed in any of the positions marked "1", "2" and "3" in accordance with the table of combinations below (Position numbers and centre marks do not form part of the signal)

Item	
1	Regulations: 10(1), 10(2), 33, 34, 36, 41(3)
2	Directions: 18(1), 18(2), 21(1), 46, 47, 55, 56
3	Diagrams: 543.1, 1001, 1001.2, 1055.1, 1055.2
4	Permitted variants: Where a signal shown in diagram 3001.2, 3001.3 or 3013 is not placed in one of the marked positions, the housing for that signal shall be omitted

Table of combinations

Item 1	Signal position	1	2	3
Item 2	Signal combinations	3013; or none	3001.2; or 3001.3	None
		None	3001.2; or 3001.3	3001.2; or 3001.3; or 3013

**Status:** This is the original version (as it was originally made). This item of legislation is currently only available in its original format.

SCHEDULE 8 LIGHT SIGNALS FOR THE CONTROL OF VEHICULAR TRAFFIC (contd.)

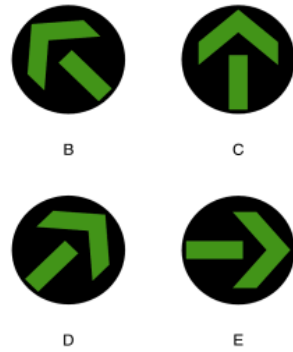
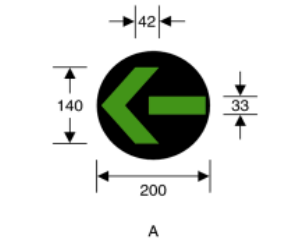

3001.2  
Green arrow for inclusion in light signals  
in accordance with regulation 34  
(Alternative indications)

Item	
1	Regulations: 10(1), 10(2), 33(4), 34, 36
2	Directions: 46, 55(11), 56
3	Diagrams: 3000.7, 3000.8, 3000.9, 3000.10
4	Permitted variants: None

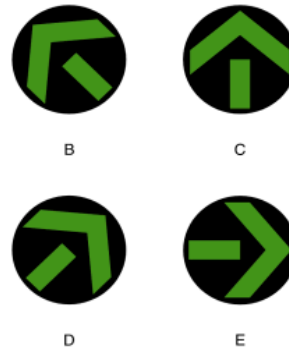
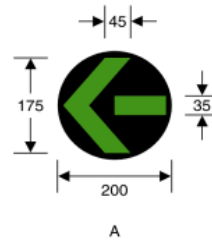

3001.3  
Same as diagram 3001.2  
(Alternative indications)

Item	
1	Regulations: 10(1), 10(2), 33(4), 34, 36
2	Directions: 46, 55(11), 56
3	Diagrams: 3000.7, 3000.8, 3000.9, 3000.10
4	Permitted variants: None

**Status:** This is the original version (as it was originally made). This item of legislation is currently only available in its original format.

SCHEDULE 8 LIGHT SIGNALS FOR THE CONTROL OF VEHICULAR TRAFFIC (contd.)

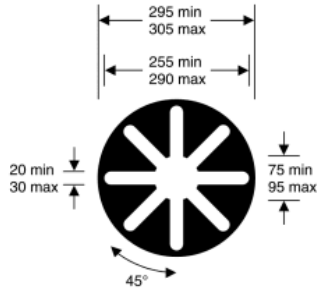

3013  
Light signal for the control of tramcars

Item	
1	Regulations: 41, 42
2	Directions: 18(1), 46, 56
3	Diagrams: 1001, 1001.1, 3000.7, 3000.8, 3000.9, 3000.10
4	Permitted variants: None

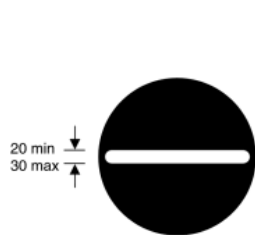

3013.1  
As diagram 3013, conveying the prohibition prescribed by regulation 42(a)

Item	
1	Regulations: 10(1), 41, 42
2	Directions: 46, 56
3	Diagrams: None
4	Permitted variants: None

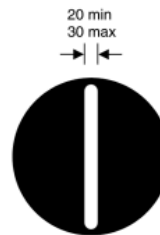

3013.2  
As diagram 3013, conveying the indication prescribed by regulation 42(b)

Item	
1	Regulations: 41, 42
2	Directions: 46, 56
3	Diagrams: None
4	Permitted variants: None

**Status:** This is the original version (as it was originally made). This item of legislation is currently only available in its original format.

SCHEDULE 8 LIGHT SIGNALS FOR THE CONTROL OF VEHICULAR TRAFFIC (contd.)

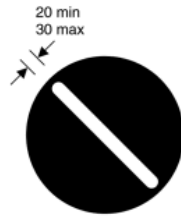

3013.3  
As diagram 3013, conveying the indication prescribed by regulation 42(c)

Item	
1	Regulations: 41, 42
2	Directions: 46, 56
3	Diagrams: None
4	Permitted variants: None

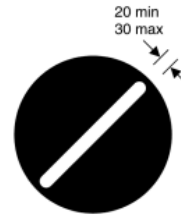

3013.4  
As diagram 3013, conveying the indication prescribed by regulation 42(d)

Item	
1	Regulations: 41, 42
2	Directions: 46, 56
3	Diagrams: None
4	Permitted variants: None

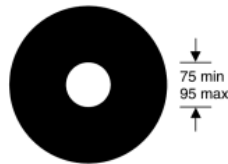

3013.5  
As diagram 3013, conveying the requirement prescribed by regulation 42(e)

Item	
1	Regulations: 41, 42
2	Directions: 46, 56
3	Diagrams: None
4	Permitted variants: None

**Status:** This is the original version (as it was originally made). This item of legislation is currently only available in its original format.

SCHEDULE 8 LIGHT SIGNALS FOR THE CONTROL OF VEHICULAR TRAFFIC (contd.)

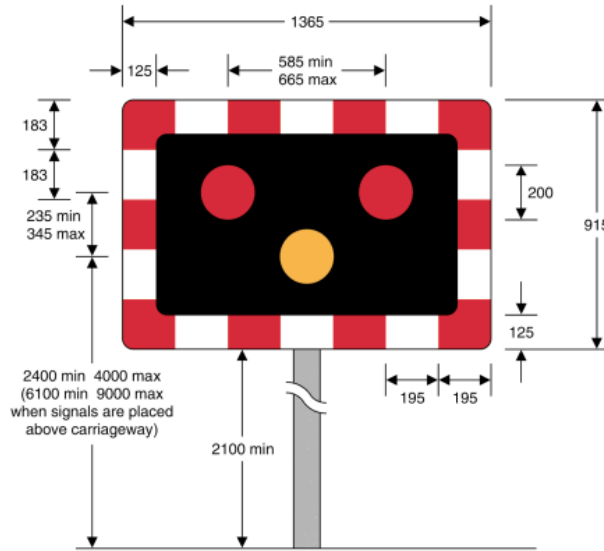

3014  
Light signals for the control of road traffic at level crossings, swing or lifting bridges, tunnels, airfields or in the vicinity of premises used regularly by fire, police or ambulance service vehicles

Item	
1	Regulations: 10(1), 10(2), 39, 40
2	Directions: 18(1), 46, 47, 55(3), 55(11), 56
3	Diagrams: 774, 775, 776, 777, 1001, 1003.2, 4006
4	Permitted variants: None
5	Illumination requirements: Schedule 17, Item 15

**Status:** This is the original version (as it was originally made). This item of legislation is currently only available in its original format.

## SCHEDULE 9

### LIGHT SIGNALS FOR PEDESTRIANS AND ANIMAL CROSSINGS

#### SCHEDULE 9

Regulations 47-52

#### LIGHT SIGNALS FOR PEDESTRIANS AND ANIMAL CROSSINGS

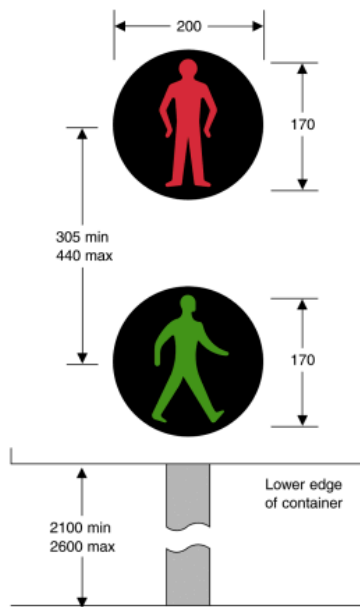

4002.1  
Light signals for pedestrians

Item	
1	Regulations: 4, 47
2	Directions: 18(1), 46, 55(4), 55(7), 56
3	Diagrams: 1001.3, 1055.1, 1055.2, 4003
4	Permitted variants: None

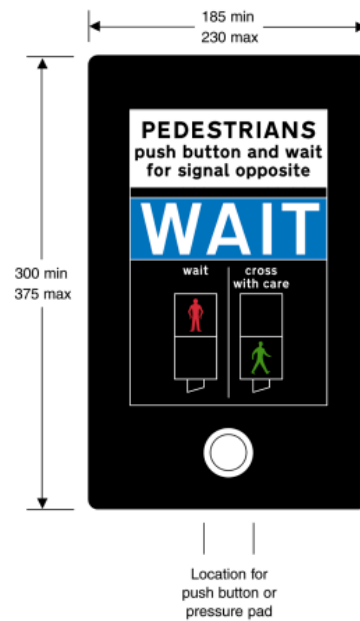

4003  
Instructions to pedestrians above the push button control for calling up pedestrian phases at light signals

Item	
1	Regulations: 4, 47(6), 47(7)
2	Directions: 46, 55(4), 56
3	Diagrams: 4002.1
4	Permitted variants: The legend "WAIT" may be illuminated in white, off-white or yellow

**Status:** This is the original version (as it was originally made). This item of legislation is currently only available in its original format.

SCHEDULE 9 LIGHT SIGNALS FOR PEDESTRIANS AND ANIMAL CROSSINGS (contd.)

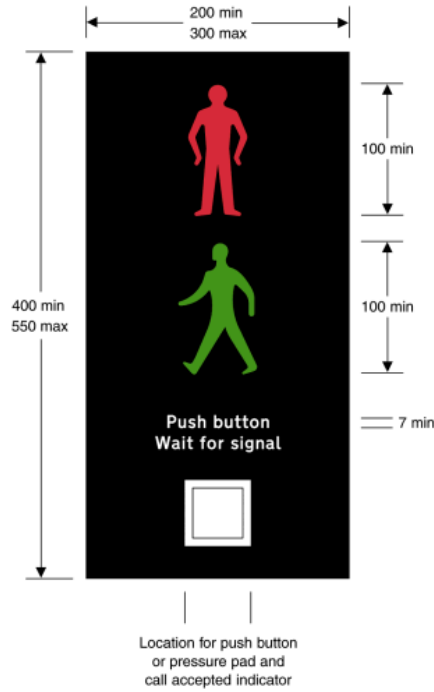

4003.1

Near side light signals and instructions for pedestrians at a pedestrian facility controlled by light signals

Item	
1	Regulations: 4, 47
2	Directions: 18(1), 46, 55(7), 56
3	Diagrams: 1001.3, 1055.1, 1055.2
4	Permitted variants: Schedule 16, item 28 The horizontal positions of the red and green figures may be varied independently of each other. Multiple red and green figures may be provided. The face containing the signal and instructions may be curved and may comprise more than one unit. The legend "Stand on mat" may be added between the legends "Push button" and "Wait for signal". The legend may be varied to another legend approved by the Secretary of State



**Status:** This is the original version (as it was originally made). This item of legislation is currently only available in its original format.

SCHEDULE 9 LIGHT SIGNALS FOR PEDESTRIANS AND ANIMAL CROSSINGS (contd.)

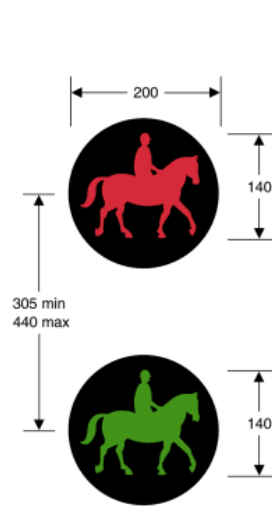

4003.2  
Light signals for equestrian traffic

Item	
1	Regulations: 4, 48
2	Directions: 18(1), 46, 49, 55(5), 55(8), 56
3	Diagrams: 1001.3, 1055.1, 1055.2, 4003.3
4	Permitted variants: None

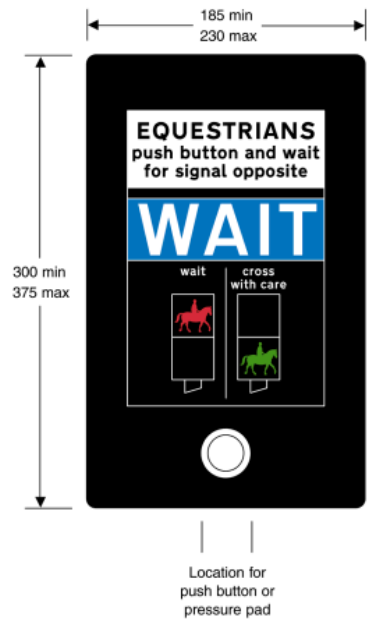

4003.3  
Instructions to horse riders above the push button control for calling up equestrian traffic phases at light signals

Item	
1	Regulations: 4, 48(6), 48(7)
2	Directions: 46, 55(5), 56
3	Diagrams: 4003.2
4	Permitted variants: The legend "WAIT" may be illuminated in white, off-white or yellow

**Status:** This is the original version (as it was originally made). This item of legislation is currently only available in its original format.

SCHEDULE 9 LIGHT SIGNALS FOR PEDESTRIANS AND ANIMAL CROSSINGS (contd.)

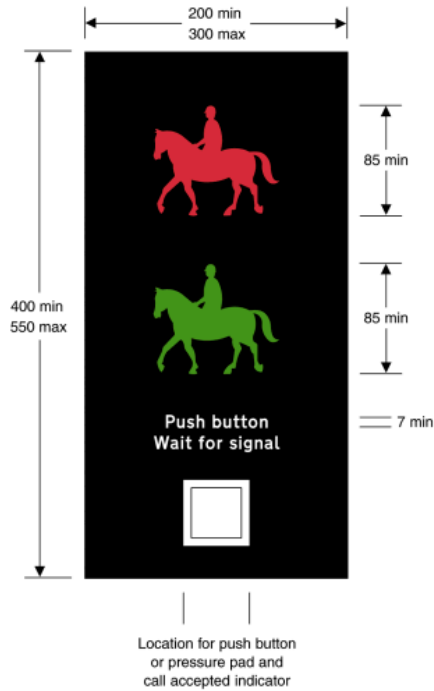

4003.4

Near side light signals and instructions for horse riders at an equestrian traffic crossing facility controlled by light signals

Item	
1	Regulations: 4, 48
2	Directions: 18(1), 46, 49, 55(8), 56
3	Diagrams: 1001.3, 1055.1, 1055.2
4	Permitted variants: Schedule 16, item 28 The horizontal positions of the red and green ridden horse symbols may be varied independently of each other. Multiple red and green ridden horse symbols may be provided. The face containing the signal and instructions may be curved and may comprise more than one unit. The legend may be varied to another legend approved by the Secretary of State

**Status:** This is the original version (as it was originally made). This item of legislation is currently only available in its original format.

SCHEDULE 9 LIGHT SIGNALS FOR PEDESTRIANS AND ANIMAL CROSSINGS (contd.)

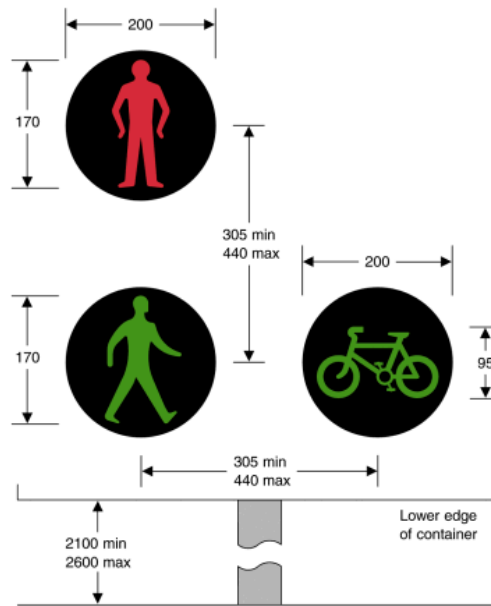

4003.5  
Light signals for pedestrians and cyclists  
at a Toucan crossing

Item	
1	Regulations: 4, 49
2	Directions: 18(1), 46, 49, 55(6), 55(9), 56
3	Diagrams: 1001.3, 1055.1, 1055.2, 4003.6
4	Permitted variants: The cycle aspect may be positioned to the left of the green pedestrian aspect

**Status:** This is the original version (as it was originally made). This item of legislation is currently only available in its original format.

SCHEDULE 9 LIGHT SIGNALS FOR PEDESTRIANS AND ANIMAL CROSSINGS (contd.)

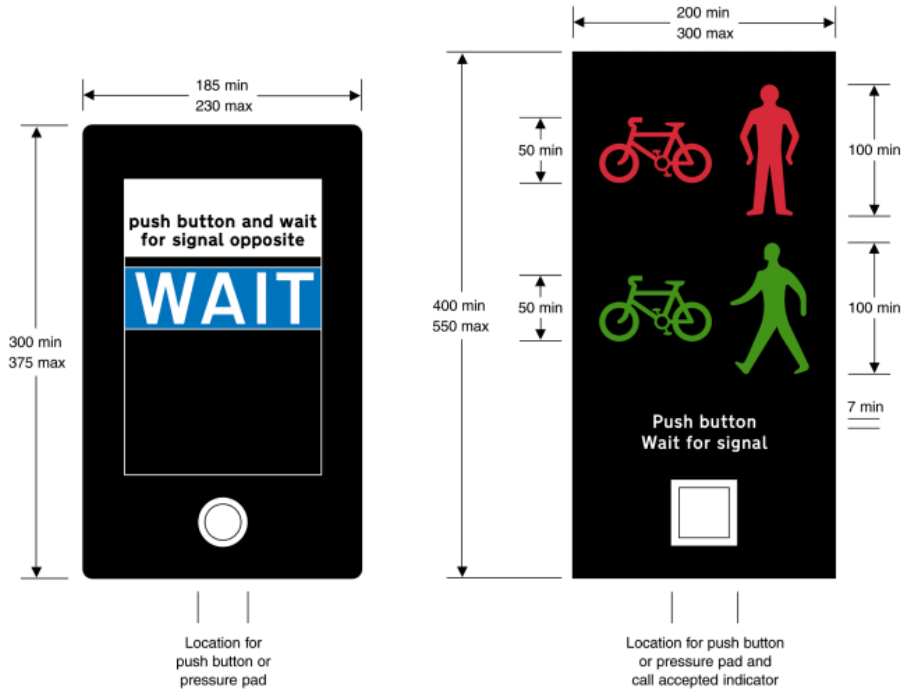

4003.6  
Instructions to pedestrians and cyclists above the push button control for calling up pedestrian and cycle phases at a Toucan crossing

Item	
1	Regulations: 4, 49(6), 49(7)
2	Directions: 46, 55(6), 56
3	Diagrams: 4003.5
4	Permitted variants: The legend "WAIT" may be illuminated in white, off-white or yellow

4003.7  
Near side light signals and instructions for pedestrians and cyclists at a Toucan crossing

Item	
1	Regulations: 4, 49
2	Directions: 18(1), 46, 49, 55(9), 56
3	Diagrams: 1001.3, 1055.1, 1055.2
4	Permitted variants: The combined cycle and pedestrian symbols may be reversed in a mirror image. The face containing the signal and instructions may be curved and may comprise more than one unit. The legend may be varied to another legend approved by the Secretary of State

**Status:** This is the original version (as it was originally made). This item of legislation is currently only available in its original format.

SCHEDULE 9 LIGHT SIGNALS FOR PEDESTRIANS AND ANIMAL CROSSINGS (contd.)

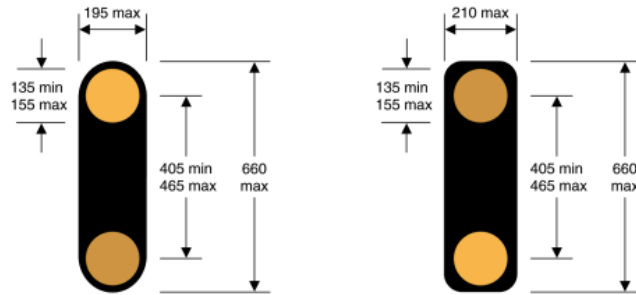

4004  
Children likely to be crossing the road  
on their way to or from school ahead  
(Alternative types)

Item	
1	Regulations: 50
2	Directions: 20(2), 27, 46, 55(1), 56
3	Diagrams: 545, 546, 547.1, 547.7
4	Permitted variants: Container may be coloured grey

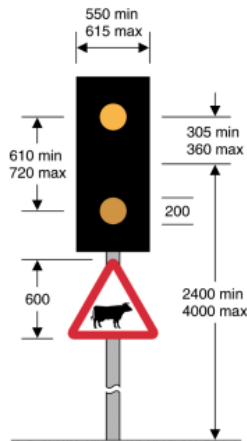

4005  
Cattle crossing ahead

Item	
1	Regulations: 51
2	Directions: 21(1), 46, 55(2), 56
3	Diagrams: 548, 548.1
4	Permitted variants: None
5	Illumination requirements: Schedule 17, item 4 (in respect of warning sign)

**Status:** This is the original version (as it was originally made). This item of legislation is currently only available in its original format.

SCHEDULE 9 LIGHT SIGNALS FOR PEDESTRIANS AND ANIMAL CROSSINGS (contd.)



4006  
Light signal at level crossing for pedestrians

Item	
1	Regulations: 52
2	Directions: 46, 55(3), 56
3	Diagrams: 1003.2, 3014
4	Permitted variants: None

**Status:** This is the original version (as it was originally made). This item of legislation is currently only available in its original format.

SCHEDULE 10  
LANE CONTROL SIGNALS AND SIGNS

PART I  
LANE CONTROL SIGNALS

SCHEDULE 10 PART I  
LANE CONTROL SIGNALS

Regulation 44

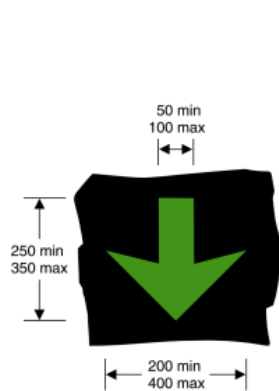

5001.1  
Lane open to vehicular traffic

Item	
1	Regulations: 12(6), 44
2	Directions: 7, 46, 56
3	Diagrams: None
4	Permitted variants: None

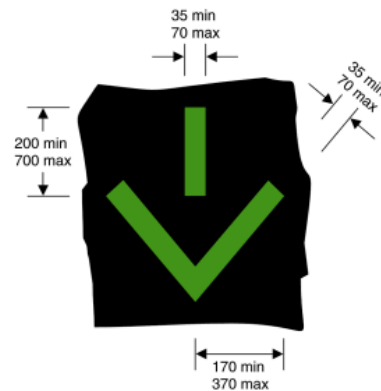

5001.2  
Same as diagram 5001.1

Item	
1	Regulations: 12(6), 44
2	Directions: 7, 46, 56
3	Diagrams: None
4	Permitted variants: None

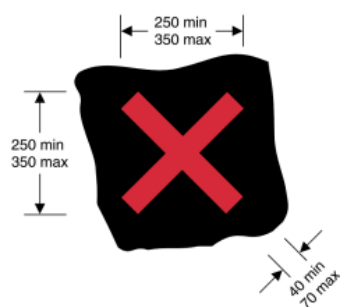

5003  
Lane closed to vehicular traffic

Item	
1	Regulations: 12(6), 44
2	Directions: 7, 46, 56
3	Diagrams: None
4	Permitted variants: None

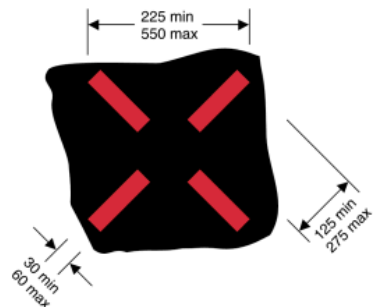

5003.1  
Same as diagram 5003

Item	
1	Regulations: 12(6), 44
2	Directions: 7, 46, 56
3	Diagrams: None
4	Permitted variants: None

**Status:** This is the original version (as it was originally made). This item of legislation is currently only available in its original format.

SCHEDULE 10 PART I LANE CONTROL SIGNALS (contd.)

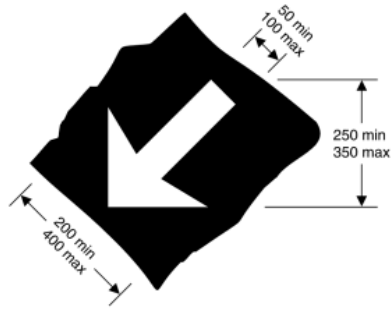

Item	
1	Regulations: 12(6), 44
2	Directions: 7, 46, 56
3	Diagrams: None
4	Permitted variants: None

5005  
Lane closed ahead and vehicular traffic should move to the next lane on the left

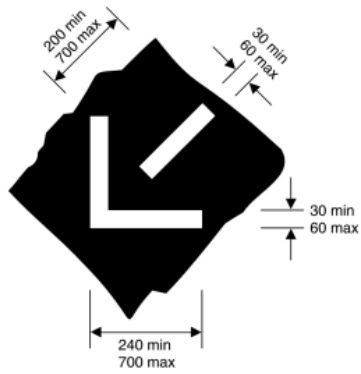

Item	
1	Regulations: 12(6), 44
2	Directions: 7, 46, 56
3	Diagrams: None
4	Permitted variants: None

5005.1  
Same as diagram 5005



**Status:** This is the original version (as it was originally made). This item of legislation is currently only available in its original format.

## PART II

### LANE CONTROL SIGNALS

#### SCHEDULE 10 PART II LANE CONTROL SIGNS

Regulation 11(1)



5010  
Lane control light signals ahead as shown in diagrams 5001.1, 5003 and 5005 or diagrams 5001.2, 5003.1 and 5005.1

Item	
1	Regulations: None
2	Directions: None
3	Diagrams: None
4	Permitted variants: The diagonal white arrow symbol and the words "move to left" shall be omitted where the signals shown in diagram 5005 or 5005.1 are not used in the lane control system
5	Illumination requirements: Schedule 17, item 1

5011  
Lane control light signals as shown in diagrams 5001.1, 5003 and 5005 or diagrams 5001.2, 5003.1 and 5005.1 on a road extending from a junction ahead

Item	
1	Regulations: None
2	Directions: None
3	Diagrams: None
4	Permitted variants: Same as diagram 5010
5	Illumination requirements: Schedule 17, item 1



5012  
System of lane control light signals ahead

Item	
1	Regulations: None
2	Directions: None
3	Diagrams: None
4	Permitted variants: None
5	Illumination requirements: Schedule 17, item 4

5013  
Direction of a system of lane control light signals

Item	
1	Regulations: None
2	Directions: None
3	Diagrams: None
4	Permitted variants: Schedule 16, item 13
5	Illumination requirements: Schedule 17, item 4

**Status:** This is the original version (as it was originally made). This item of legislation is currently only available in its original format.

SCHEDULE 10 PART II LANE CONTROL SIGNS (contd.)

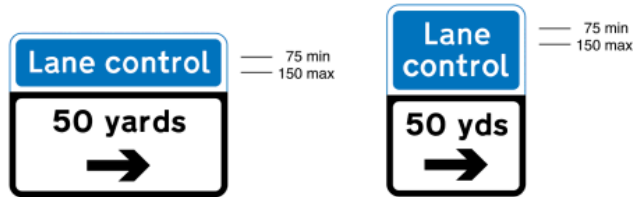

5014  
Distance to and direction of a system of lane control light signals (Alternative types)

Item	
1	Regulations: None
2	Directions: None
3	Diagrams: None
4	Permitted variants: Schedule 16, items 6, 13, 14
5	Illumination requirements: Schedule 17, item 4



5015  
End of a system of lane control light signals

Item	
1	Regulations: 44(4)
2	Directions: None
3	Diagrams: None
4	Permitted variants: None
5	Illumination requirements: Schedule 17, item 4

**Status:** This is the original version (as it was originally made). This item of legislation is currently only available in its original format.

## SCHEDULE 11

### MATRIX SIGNS AND LIGHT SIGNALS

## PART I MATRIX SIGNS

### SCHEDULE 11 PART I

Regulation 46

#### MATRIX SIGNS

(for motorways and all-purpose dual carriageway roads)

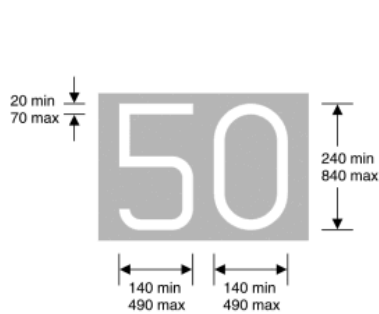

6001  
Temporary maximum speed advised

Item	
1	Regulations: 46, 58(6)
2	Directions: 46, 50, 51, 56
3	Diagrams: 6021, 6022
4	Permitted variants: Schedule 16, item 1

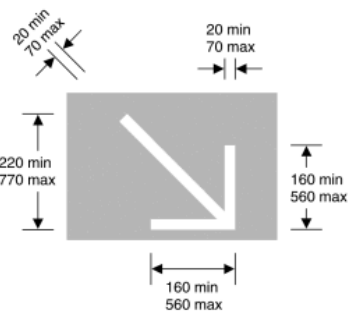

6002  
Vehicular traffic must move to the next lane on the right

Item	
1	Regulations: 46, 58(6)
2	Directions: 46, 50, 51, 52, 56
3	Diagrams: 6021
4	Permitted variants: Arrow may point downwards to the left

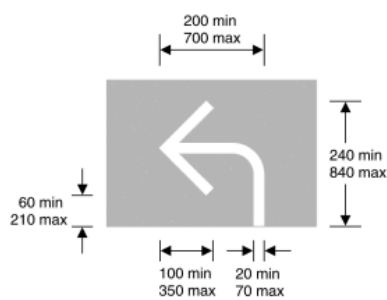

6003  
Vehicular traffic must leave at next junction

Item	
1	Regulations: 46, 58(6)
2	Directions: 46, 50, 51, 56
3	Diagrams: 6021, 6022
4	Permitted variants: Schedule 16, item 28

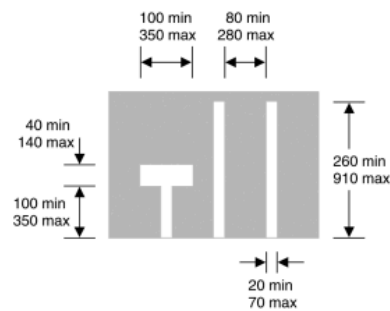

6006  
Closure of one lane of a three lane carriageway ahead

Item	
1	Regulations: 46, 58(6)
2	Directions: 46, 50, 51, 52, 56
3	Diagrams: 6022
4	Permitted variants: Schedule 16, item 16

**Status:** This is the original version (as it was originally made). This item of legislation is currently only available in its original format.

SCHEDULE 11 PART I MATRIX SIGNS (contd.)

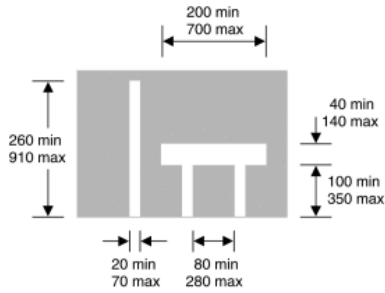

6006.1  
Closure of two lanes of a three lane carriageway ahead

Item	
1	Regulations: 46, 58(6)
2	Directions: 46, 50, 51, 52, 56
3	Diagrams: 6022
4	Permitted variants: Schedule 16, item 16

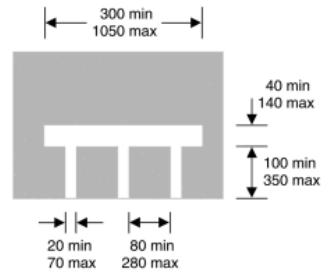

6006.2  
Closure of all lanes of a three lane carriageway ahead

Item	
1	Regulations: 46, 58(6)
2	Directions: 46, 50, 51, 52, 56
3	Diagrams: 6032.1
4	Permitted variants: None

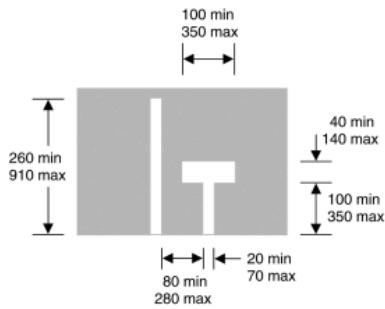

6008  
Closure of right hand lane of a two lane carriageway ahead

Item	
1	Regulations: 46, 58(6)
2	Directions: 46, 50, 51, 52, 56
3	Diagrams: 6022
4	Permitted variants: Schedule 16, item 16

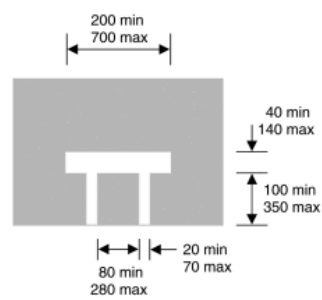

6008.1  
Closure of both lanes of a two lane carriageway ahead

Item	
1	Regulations: 46, 58(6)
2	Directions: 46, 50, 51, 52, 56
3	Diagrams: 6032.1
4	Permitted variants: None

**Status:** This is the original version (as it was originally made). This item of legislation is currently only available in its original format.

SCHEDULE 11 PART I MATRIX SIGNS (contd.)

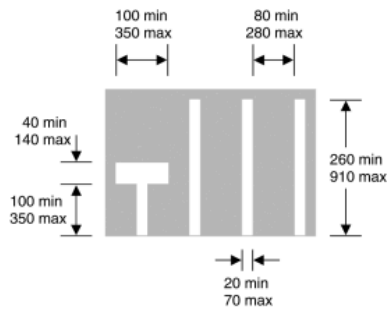

6009  
Closure of one lane of a four lane carriageway ahead

Item	
1	Regulations: 46, 58(6)
2	Directions: 46, 50, 51, 52, 56
3	Diagrams: 6022
4	Permitted variants: Schedule 16, item 16

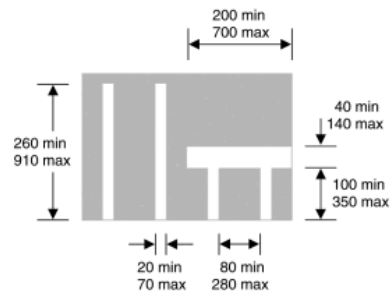

6009.1  
Closure of two lanes of a four lane carriageway ahead

Item	
1	Regulations: 46, 58(6)
2	Directions: 46, 50, 51, 52, 56
3	Diagrams: 6022
4	Permitted variants: Schedule 16, item 16

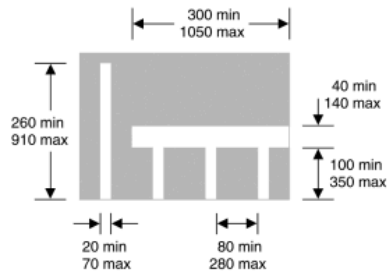

6009.2  
Closure of three lanes of a four lane carriageway ahead

Item	
1	Regulations: 46, 58(6)
2	Directions: 46, 50, 51, 52, 56
3	Diagrams: 6022
4	Permitted variants: Schedule 16, item 16

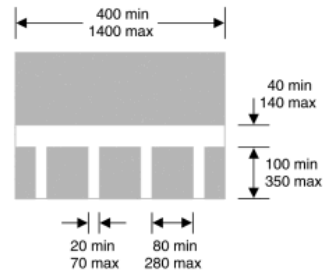

6009.3  
Closure of all lanes of a four lane carriageway ahead

Item	
1	Regulations: 46, 58(6)
2	Directions: 46, 50, 51, 52, 56
3	Diagrams: 6032.1
4	Permitted variants: None

**Status:** This is the original version (as it was originally made). This item of legislation is currently only available in its original format.

SCHEDULE 11 PART I MATRIX SIGNS (contd.)

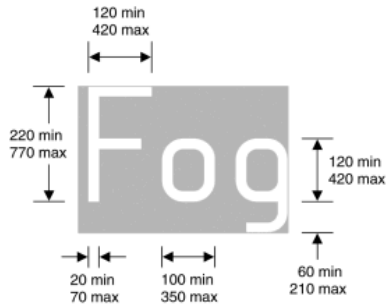

6011  
Risk of fog ahead

Item	
1	Regulations: 46, 58(6)
2	Directions: 46, 50, 51, 56
3	Diagrams: 6021, 6022
4	Permitted variants: None

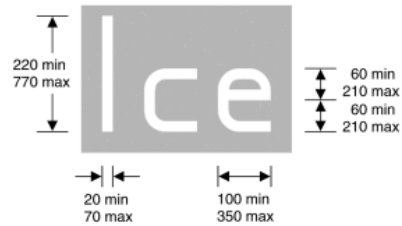

6011.1  
Risk of ice ahead

Item	
1	Regulations: 46, 58(6)
2	Directions: 46, 50, 51, 56
3	Diagrams: 6021, 6022
4	Permitted variants: None

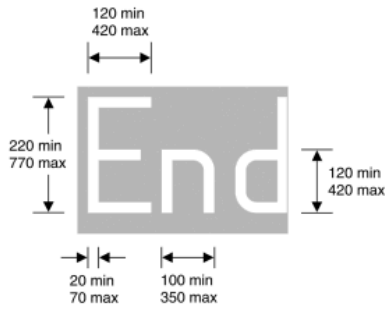

6012  
End of temporary restrictions  
indicated by previous signs

Item	
1	Regulations: 46, 58(6)
2	Directions: 46, 50, 51, 56
3	Diagrams: None
4	Permitted variants: None

**Status:** This is the original version (as it was originally made). This item of legislation is currently only available in its original format.

SCHEDULE 11 PART I MATRIX SIGNS (contd.)

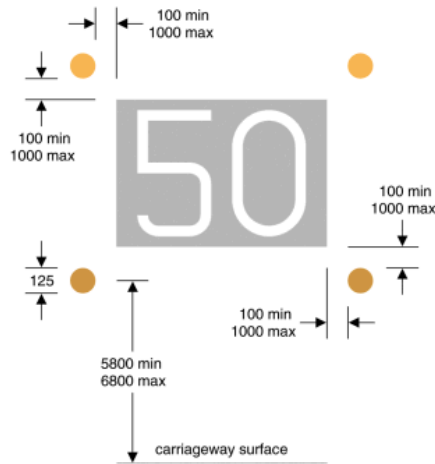

6021  
Gantry-mounted signal with flashing amber lamps for displaying the signs shown in diagrams 6001, 6002, 6003, 6011 or 6011.1

Item	
1	Regulations: 46, 58(6)
2	Directions: 46, 50, 52, 56
3	Diagrams: None
4	Permitted variants: "50" may be varied to any of the legends shown in diagrams 6001, 6002, 6003, 6011 or 6011.1

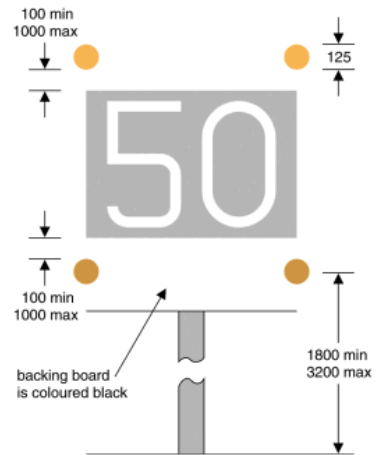

6022  
Post-mounted signal with flashing amber lamps for displaying the signs shown in diagrams 6001, 6003, 6006, 6006.1, 6008, 6009, 6009.1, 6009.2, 6011 or 6011.1

Item	
1	Regulations: 46, 58(6)
2	Directions: 46, 50, 52, 56
3	Diagrams: None
4	Permitted variants: "50" may be varied to any of the legends shown in diagrams 6001, 6003, 6006, 6006.1, 6008, 6009, 6009.1, 6009.2, 6011 or 6011.1 An identification number may be added to the backing board or post in horizontal or vertical format as appropriate

**Status:** This is the original version (as it was originally made). This item of legislation is currently only available in its original format.

## PART II LIGHT SIGNALS

### SCHEDULE 11 PART II LIGHT SIGNALS (for motorways and all-purpose dual carriageway roads)

Regulations 37 and 45

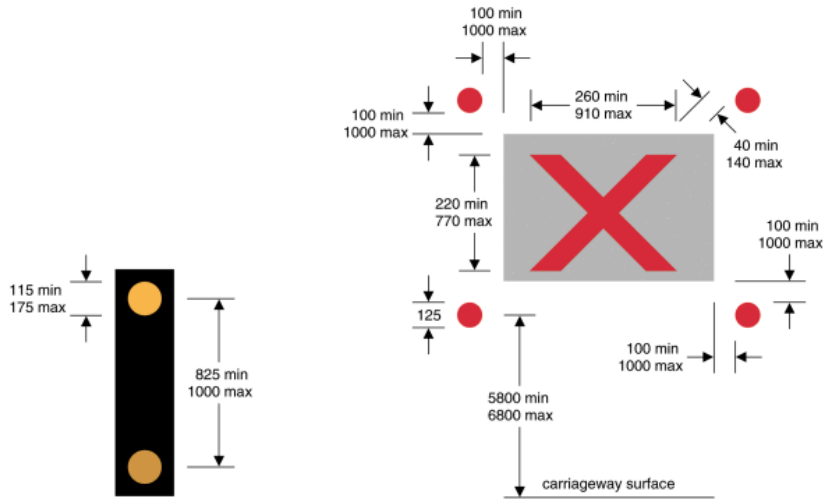

**6023**  
Light signal conveying the warning prescribed in regulation 45

**6031.1**  
Light signals conveying the requirement prescribed in regulation 38(b)

Item	
1	Regulations: 45
2	Directions: 46, 50, 56
3	Diagrams: None
4	Permitted variants: None

Item	
1	Regulations: 10(1), 10(2), 37, 38
2	Directions: 46, 50, 51, 52, 56
3	Diagrams: None
4	Permitted variants: None



**Status:** This is the original version (as it was originally made). This item of legislation is currently only available in its original format.

SCHEDULE 11 PART II LIGHT SIGNALS (contd.)

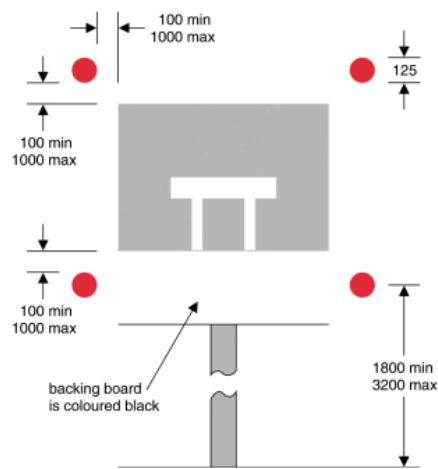

6032.1  
Light signals conveying the requirement  
prescribed in regulation 38(a)

Item	
1	Regulations: 10(1), 10(2), 37, 38
2	Directions: 46, 50, 51, 52, 56
3	Diagrams: None
4	Permitted variants: The diagram 6008.1 symbol may be varied to the symbol shown in diagram 6006.2 or 6009.3 An identification number may be added to the backing board or post in horizontal or vertical format as appropriate

*Status: This is the original version (as it was originally made). This item of legislation is currently only available in its original format.*

SCHEDULE 12

ROAD WORKS SIGNS ETC

PART I

MISCELLANEOUS WARNING, INFORMATORY AND REGULATORY SIGNS FOR ROAD WORKS ETC

SCHEDULE 12 PART I

Regulation 11(1)

MISCELLANEOUS WARNING, INFORMATORY AND REGULATORY SIGNS FOR ROAD WORKS ETC



600  
(750)  
(900)  
(1200)  
(1500)

7001  
Road works or temporary obstruction of the carriageway ahead

Item	
1	Regulations: 14(1), 54
2	Directions: 10(3), 21(1), 36
3	Diagrams: 570, 572, 573, 645, 7001.1, 7001.2, 7021
4	Permitted variants: None
5	Illumination requirements: Schedule 17, item 1



50  
(62.5)  
(75)  
(100)  
(125)  
(150)

7001.1  
Nature of road works

Item	
1	Regulations: 14(1)
2	Directions: 21(1), 36
3	Diagrams: 7001
4	Permitted variants: Schedule 16, items 3, 6, 11 "for" may precede a distance where added. "Line painting" may be on two lines or varied to: <ol style="list-style-type: none"> <li>1. "Grass cutting"</li> <li>2. "Tree cutting"</li> <li>3. "Hedge cutting"</li> <li>4. "Ditching"</li> <li>5. "Weed spraying"</li> <li>6. "Sign erection"</li> <li>7. "Sign maintenance"</li> <li>8. "Lighting maintenance"</li> <li>9. "Overhead works"</li> <li>10. "On slip road"</li> <li>11. "Surveying"</li> <li>12. "Mobile road works"</li> <li>13. "Road sweeping"</li> <li>14. "Gully emptying"</li> <li>15. "Gritting"</li> <li>16. "Salting"</li> <li>17. "Snow ploughing"</li> <li>18. "Blasting"</li> <li>19. "On hard shoulder"</li> <li>20. "At level crossing"</li> </ol>
5	Illumination requirements: Schedule 17, item 8



(50)  
(62.5)  
(75)  
(100)  
(125)  
(150)  
(200)

7001.2  
Location of road works immediately ahead on route indicated

Item	
1	Regulations: None
2	Directions: 21(1), 36
3	Diagrams: 7001
4	Permitted variants: Schedule 16, item 20 Direction may be varied or omitted and "On" added before route number
5	Illumination requirements: Schedule 17, item 8

**Status:** This is the original version (as it was originally made). This item of legislation is currently only available in its original format.

SCHEDULE 12 PART I MISCELLANEOUS WARNING, INFORMATORY AND REGULATORY SIGNS FOR ROAD WORKS ETC (contd.)



100 min  
250 max

140 min  
350 max

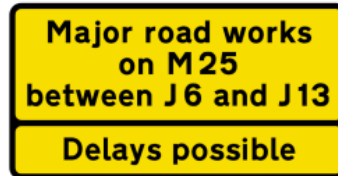

75 min  
250 max

7001.3

Vehicular traffic should proceed slowly owing to workforce in road ahead

Item	
1	Regulations: 54
2	Directions: 36
3	Diagrams: None
4	Permitted variants: "WORKFORCE IN ROAD" may be varied to "SETTING OUT ROAD WORKS AHEAD" and "SLOW" omitted
5	Illumination requirements: Schedule 17, item 1

7002A

Major road works at a specified location ahead

Item	
1	Regulations: None
2	Directions: 36
3	Diagrams: None
4	Permitted variants: Schedule 16, items 20, 38 Details of road works may be varied as appropriate. "J6 and J13" may be varied to "Junctions 6 and 13". The bottom panel may be omitted
5	Illumination requirements: Schedule 17, item 4

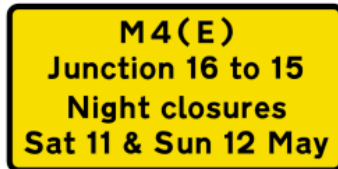

75 min  
250 max



75 min  
250 max

7002B

Time and date when a route is to be closed to traffic

Item	
1	Regulations: None
2	Directions: 36
3	Diagrams: None
4	Permitted variants: Schedule 16, items 20, 38 Details of route to be closed may be varied as appropriate. "Junction 16 to 15" may be varied to "J 16 to J 15"
5	Illumination requirements: Schedule 17, item 4

7002.1

Dates when road works are to take place overnight and delays are to be expected

Item	
1	Regulations: None
2	Directions: 36
3	Diagrams: 7025, 7026, 7027, 7028, 7029
4	Permitted variants: Schedule 16, item 38 "Expect delays" may be varied to "Delays possible"
5	Illumination requirements: Schedule 17, item 4

**Status:** This is the original version (as it was originally made). This item of legislation is currently only available in its original format.

SCHEDULE 12 PART I MISCELLANEOUS WARNING, INFORMATORY AND REGULATORY SIGNS FOR ROAD WORKS ETC (contd.)



7003.1  
Starting date and duration of road works

Item	
1	Regulations: 13(2), 13(4), 13(7)
2	Directions: 36
3	Diagrams: None
4	Permitted variants: Schedule 16, items 38, 40 Duration of work may be varied. "until" and a date may be substituted for "for 3 weeks". The upper or lower part of the sign, or both may be omitted. The diagram 7001 sign may be omitted
5	Illumination requirements: Schedule 17, item 4



7004  
Road works ahead and the nature of works indicated

Item	
1	Regulations: 54
2	Directions: 36
3	Diagrams: None
4	Permitted variants: Schedule 16, item 6 "Replacing damaged bridge supports" may be varied to a short description of the work in progress or explanation of why work is suspended. The distance plate may be replaced with a plate of the type shown in diagram 570. The diagram 7001 sign and distance plate may be omitted
5	Illumination requirements: Schedule 17, item 1

**Status:** This is the original version (as it was originally made). This item of legislation is currently only available in its original format.

SCHEDULE 12 PART I MISCELLANEOUS WARNING, INFORMATORY AND REGULATORY SIGNS FOR ROAD WORKS ETC (contd.)



7005  
Delays possible for specified period owing to road works ahead

Item	
1	Regulations: 54
2	Directions: 36
3	Diagrams: None
4	Permitted variants: Schedule 16, item 38 The phrase "until Mar 02" may be omitted. The diagram 7001 sign and distance plate may be omitted
5	Illumination requirements: Schedule 17, item 1



7006  
End of road works and of any associated temporary statutory restrictions

Item	
1	Regulations: 13(2), 13(4), 13(7)
2	Directions: 10(3), 36
3	Diagrams: None
4	Permitted variants: Schedule 16, item 40 The Highways Agency panel and the horizontal line below "delay" may be omitted
5	Illumination requirements: Schedule 17, item 1



7006.1  
Information on telephone number to be used for enquiries about road works

Item	
1	Regulations: 13(2), 13(4), 13(7)
2	Directions: 36
3	Diagrams: None
4	Permitted variants: Schedule 16, item 40 The telephone number shall be varied as appropriate
5	Illumination requirements: Schedule 17, item 4



7007.1  
Relevant particulars of major construction or improvement scheme being carried out on road ahead

Item	
1	Regulations: 13(2), 13(4), 13(7)
2	Directions: 36
3	Diagrams: None
4	Permitted variants: Schedule 16, item 40 Details shown shall be varied as appropriate
5	Illumination requirements: Schedule 17, item 9

**Status:** This is the original version (as it was originally made). This item of legislation is currently only available in its original format.

SCHEDULE 12 PART I MISCELLANEOUS WARNING, INFORMATORY AND REGULATORY SIGNS FOR ROAD WORKS ETC (contd.)



7008  
Nature of street works, giving names of employer and contractor, emergency telephone number, and apology for inconvenience (Sign for pedestrians)

Item	
1	Regulations: 13(2), 13(4), 13(7)
2	Directions: 36
3	Diagrams: None
4	Permitted variants: Details shown shall be varied as appropriate. Each line of legend may have a different size of lettering which shall be smaller than the emergency telephone number. The description of the works, the completion date and the name of the contractor may be omitted as appropriate. The top and bottom panels may be in any colours and style of lettering. A logo indicating membership of a national street works good practice scheme may be added to the top or bottom panel. The bottom panel may be omitted. The top panel may be omitted and the Undertaker's name shown on the main panel
5	Illumination requirements: Schedule 17, item 9

600  
(750)  
(900)  
(1200)  
(1500)



7009  
Loose chippings on road ahead

Item	
1	Regulations: 54
2	Directions: 21(1), 36
3	Diagrams: 513.2, 570, 572, 573
4	Permitted variants: None
5	Illumination requirements: Schedule 17, item 1



50 min  
200 max

7010.1  
Vehicular traffic should proceed slowly owing to temporary hazard resulting from wet tar on the road

Item	
1	Regulations: 54
2	Directions: 36
3	Diagrams: None
4	Permitted variants: "SLOW WET TAR" may be varied to: 1. "ADVERSE CAMBER" 2. "RAMP AHEAD" 3. "ROAD AHEAD CLOSED" 4. "ROAD CLOSED" (name of road may be substituted for "ROAD") 5. "TEMPORARY ROAD SURFACE" 6. "TRAFFIC CONTROL AHEAD" 7. "TRAFFIC SIGN MAINTENANCE" 8. "TRAFFIC SIGNAL MAINTENANCE" 9. "WORK IN CENTRE OF ROAD"
5	Illumination requirements: Schedule 17, item 1

**Status:** This is the original version (as it was originally made). This item of legislation is currently only available in its original format.

SCHEDULE 12 PART I MISCELLANEOUS WARNING, INFORMATORY AND REGULATORY SIGNS FOR ROAD WORKS ETC (contd.)

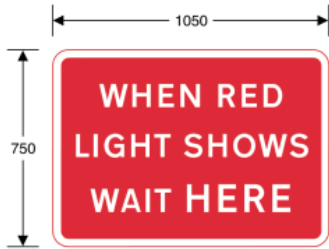

7011

Point beyond which vehicular traffic must not proceed when required to stop by regulation 36 in accordance with the indication given by the portable light signals shown in diagram 3000.1 and when the road marking shown in diagram 1001 is not placed on the carriageway

Item	
1	Regulations: 43
2	Directions: 36
3	Diagrams: 3000.1, 7023
4	Permitted variants: "RED LIGHT" may be varied to "STOP SIGN"
5	Illumination requirements: Schedule 17, item 1



7011.1

Same as diagram 7011 where there is a road junction

Item	
1	Regulations: 43
2	Directions: 36
3	Diagrams: 3000.1
4	Permitted variants: "3-WAY" may be varied to "4-WAY"
5	Illumination requirements: Schedule 17, item 1



50 min  
200 max

7012

Temporary absence of road markings

Item	
1	Regulations: 54
2	Directions: 36
3	Diagrams: None
4	Permitted variants: Schedule 16, item 6 "NO ROAD MARKINGS FOR 2 MILES" may be varied to: 1. "NO GIVE WAY MARKINGS" 2. "NO STOP MARKINGS" 3. "NO ROAD MARKINGS" 4. "NO ROAD MARKINGS AT JUNCTION" 5. "NO ROAD MARKINGS AT LEVEL CROSSING" 6. "NO ROAD STUDS FOR 2 MILES"
5	Illumination requirements: Schedule 17, item 1

**Status:** This is the original version (as it was originally made). This item of legislation is currently only available in its original format.

SCHEDULE 12 PART I MISCELLANEOUS WARNING, INFORMATORY AND REGULATORY SIGNS FOR ROAD WORKS ETC (contd.)



7013  
Temporary sudden change in level of carriageway surface

Item	
1	Regulations: 54
2	Directions: 36
3	Diagrams: None
4	Permitted variants: None
5	Illumination requirements: Schedule 17, item 1



7014  
Permanent change in road layout ahead

50 min  
200 max



7015  
Temporary absence of hard shoulder for distance specified

100 min  
200 max

Item	
1	Regulations: None
2	Directions: 36, 37(1)
3	Diagrams: None
4	Permitted variants: "NEW ROUNDABOUT" may be varied to: 1. "CHANGED PRIORITIES" 2. "GAP CLOSED" 3. "NEW ONE WAY SYSTEM" 4. "NEW ROAD LAYOUT" 5. "NEW TRAFFIC ISLANDS" 6. "NEW TRAFFIC SIGNALS" 7. "NEW ZEBRA CROSSING" 8. "SIGNAL PRIORITIES CHANGED" 9. "SIGNAL TIMINGS CHANGED" A distance in yards to the nearest 10 yards may be substituted for, or added before the word "AHEAD" on a separate line where necessary and shall be expressed as "yards" or "yds"
5	Illumination requirements: Schedule 17, item 4

Item	
1	Regulations: None
2	Directions: 36
3	Diagrams: None
4	Permitted variants: Schedule 16, item 6 The legend may be on three lines
5	Illumination requirements: Schedule 17, item 4



**Status:** This is the original version (as it was originally made). This item of legislation is currently only available in its original format.

SCHEDULE 12 PART I MISCELLANEOUS WARNING, INFORMATORY AND REGULATORY SIGNS FOR ROAD WORKS ETC (contd.)



7016  
Zebra or signal controlled crossing facility temporarily out of use  
(Sign for pedestrians, cyclists or equestrians)

Item	
1	Regulations: None
2	Directions: 36
3	Diagrams: None
4	Permitted variants: None
5	Illumination requirements: Schedule 17, item 9

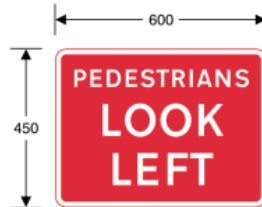

7017  
Direction in which pedestrians should look for approaching traffic  
(Sign for pedestrians)

Item	
1	Regulations: None
2	Directions: 36
3	Diagrams: None
4	Permitted variants: "LEFT" may be varied to "RIGHT" or "BOTH WAYS"
5	Illumination requirements: Schedule 17, item 9

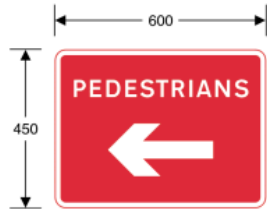

7018  
Direction of temporary route for pedestrians  
(Sign for pedestrians)

Item	
1	Regulations: None
2	Directions: 36
3	Diagrams: None
4	Permitted variants: Schedule 16, item 12 "USE OTHER FOOTWAY" may be substituted for the arrow
5	Illumination requirements: Schedule 17, item 9



7018.1  
Pedal cyclists to dismount and use adjacent footway

Item	
1	Regulations: None
2	Directions: 36
3	Diagrams: None
4	Permitted variants: None
5	Illumination requirements: Schedule 17, item 9

**Status:** This is the original version (as it was originally made). This item of legislation is currently only available in its original format.

SCHEDULE 12 PART I MISCELLANEOUS WARNING, INFORMATORY AND REGULATORY SIGNS FOR ROAD WORKS ETC (contd.)

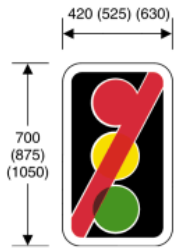

7019  
Light signals not in use

Item	
1	Regulations: 54
2	Directions: 36
3	Diagrams: None
4	Permitted variants: None
5	Illumination requirements: Schedule 17, item 4



7020  
Variable message sign ahead  
not in use or being tested

Item	
1	Regulations: 54
2	Directions: 36
3	Diagrams: None
4	Permitted variants: "SIGN" may be varied to "SIGNAL". "NOT IN USE" may be varied to "UNDER TEST". The legend may be on three lines
5	Illumination requirements: Schedule 17, item 4



7021  
Traffic on road ahead is being controlled  
by portable light signals  
(Indication to traffic joining that road)

Item	
1	Regulations: 54
2	Directions: 21(1), 36
3	Diagrams: 7001
4	Permitted variants: None
5	Illumination requirements: Schedule 17, item 8



7022  
Traffic joining a length of road being  
controlled by portable light signals  
is not controlled by such signals

Item	
1	Regulations: 54
2	Directions: 20(1), 21(1), 36
3	Diagrams: 562
4	Permitted variants: None
5	Illumination requirements: Schedule 17, item 8

**Status:** This is the original version (as it was originally made). This item of legislation is currently only available in its original format.

SCHEDULE 12 PART I MISCELLANEOUS WARNING, INFORMATORY AND REGULATORY SIGNS FOR ROAD WORKS ETC (contd.)

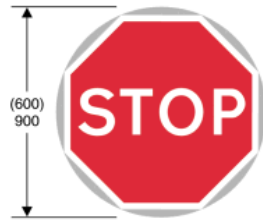

7023

Vehicular traffic must not proceed into a length of road where one-way working is temporarily necessary (Manually operated sign)

Item	
1	Regulations: 10(1), 58(9)
2	Directions: 36, 39(1)
3	Diagrams: 7011, 7024, 7027
4	Permitted variants: None
5	Illumination requirements: Schedule 17, item 5

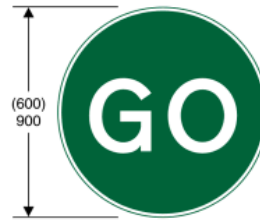

7024

Vehicular traffic may proceed into a length of road where one-way working is temporarily necessary (Manually operated sign)

Item	
1	Regulations: 58(9)
2	Directions: 36, 39(1)
3	Diagrams: 7023, 7028
4	Permitted variants: None
5	Illumination requirements: Schedule 17, item 5



7025

Vehicles to be escorted in convoys through road works ahead

Item	
1	Regulations: None
2	Directions: 36, 39(2)
3	Diagrams: 7002.1, 7026, 7027, 7028, 7029
4	Permitted variants: None
5	Illumination requirements: Schedule 17, item 4



7026

Explanation of reason for escorting vehicles in convoys through road works

Item	
1	Regulations: None
2	Directions: 36, 39(2)
3	Diagrams: 7002.1, 7025, 7027, 7028, 7029
4	Permitted variants: None
5	Illumination requirements: Schedule 17, item 4

**Status:** This is the original version (as it was originally made). This item of legislation is currently only available in its original format.

SCHEDULE 12 PART I MISCELLANEOUS WARNING, INFORMATORY AND REGULATORY SIGNS FOR ROAD WORKS ETC (contd.)



7027  
Same as diagram 7011 where vehicles are to be escorted in convoys through road works

Item	
1	Regulations: 43
2	Directions: 36, 39(2)
3	Diagrams: 3000.1, 7002.1, 7023, 7025, 7026, 7028, 7029
4	Permitted variants: "RED LIGHT" may be varied to "STOP SIGN"
5	Illumination requirements: Schedule 17, item 1



7028  
Vehicular traffic must follow the vehicle escorting the convoy through the road works

Item	
1	Regulations: None
2	Directions: 36, 39(2)
3	Diagrams: 3000.1, 7002.1, 7024, 7025, 7026, 7027, 7029
4	Permitted variants: "WHEN GREEN LIGHT SHOWS" may be varied to "AT TRAFFIC CONTROL"
5	Illumination requirements: Schedule 17, item 4



7029  
Vehicular traffic must not overtake the vehicle used to escort other vehicles through road works

Item	
1	Regulations: 10(1), 14(3)
2	Directions: 36, 39(2)
3	Diagrams: 7002.1, 7025, 7026, 7027, 7028
4	Permitted variants: "NO OVERTAKING" may be omitted. "CONVOY VEHICLE" may be on one line
5	Illumination requirements: Schedule 17, item 4



7030  
Temporary traffic control ahead where vehicles are to be escorted in convoys through road works

Item	
1	Regulations: None
2	Directions: 21(1), 36, 39(2)
3	Diagrams: 543
4	Permitted variants: Schedule 16, items 6, 9, 11 "Traffic control" may be on one line
5	Illumination requirements: Schedule 17, item 8

**Status:** This is the original version (as it was originally made). This item of legislation is currently only available in its original format.

SCHEDULE 12 PART I MISCELLANEOUS WARNING, INFORMATORY AND REGULATORY SIGNS FOR ROAD WORKS ETC (contd.)

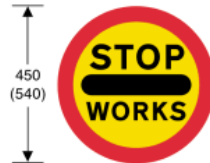

7031  
 Vehicular traffic must not proceed beyond the sign when displayed for a short period during works on or near a road (Double sided sign)

Item	
1	Regulations: 10(1), 19(4)
2	Directions: 13(3), 36, 41(5)
3	Diagrams: None
4	Permitted variants: A red or transparent protective strip, with a visible width not exceeding 6 millimetres, may be applied to the perimeter of the sign
5	Illumination requirements: Schedule 17, items 5, 15



7032  
 Commencement point of a newly imposed 30mph speed limit which is contiguous to an existing 30mph speed limit

Item	
1	Regulations: None
2	Directions: 36, 37(2)
3	Diagrams: None
4	Permitted variants: None
5	Illumination requirements: Schedule 17, item 4

**Status:** This is the original version (as it was originally made). This item of legislation is currently only available in its original format.

## PART II

### ROAD WORKS DELINEATORS AND BARRIERS

#### SCHEDULE 12 PART II ROAD WORKS DELINEATORS AND BARRIERS

Regulation 11(1)

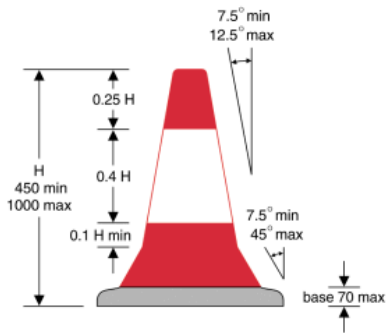

Item	
1	Regulations: 54, 56
2	Directions: 36, 41(6), 42(1)
3	Diagrams: 7104, 7105
4	Permitted variants: None
5	Illumination requirements: Schedule 17, item 16

7101.1  
Edge of a route for vehicular traffic  
through or past a temporary obstruction  
(Traffic cone)

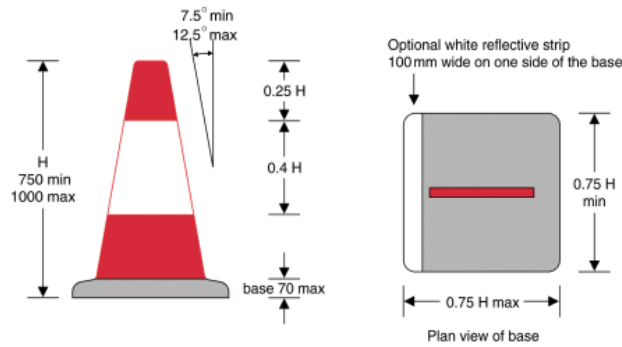

7102  
Edge of a route for vehicular traffic  
through or past a temporary obstruction  
on a motorway or dual carriageway road  
(Flat traffic delineator)

Item	
1	Regulations: 11(2), 54, 56
2	Directions: 36, 42(1)
3	Diagrams: None
4	Permitted variants: None
5	Illumination requirements: Schedule 17, item 16

**Status:** This is the original version (as it was originally made). This item of legislation is currently only available in its original format.

SCHEDULE 12 PART II ROAD WORKS DELINEATORS AND BARRIERS (contd.)

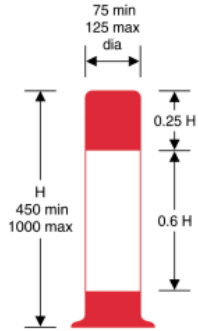

7103

Line of division of traffic flows on one carriageway, or to indicate the edge of a route for vehicular traffic through or past a temporary obstruction, or to mark a boundary between two carriageways of a dual carriageway which may not be crossed except for fire brigade, ambulance or police purposes (Traffic cylinder)

Item	
1	Regulations: 56
2	Directions: 36, 42(1)
3	Diagrams: None
4	Permitted variants: None
5	Illumination requirements: Schedule 17, item 16

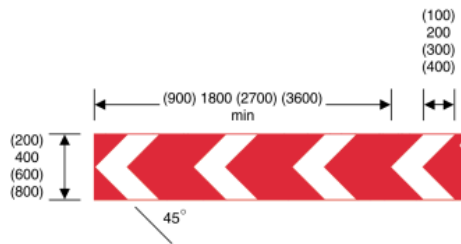

7104

Sharp deviation of route to the left at or near road works or other temporary obstructions

Item	
1	Regulations: None
2	Directions: 36, 41(6), 42(1), 42(3)
3	Diagrams: 7101.1
4	Permitted variants: Schedule 16, item 13
5	Illumination requirements: Schedule 17, item 4

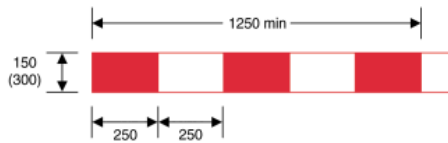

7105

Position of barrier to mark length of road closed to traffic or to guide traffic past an obstruction

Item	
1	Regulations: 54
2	Directions: 36, 41(6), 42(1), 42(3)
3	Diagrams: 7101.1
4	Permitted variants: None
5	Illumination requirements: Schedule 17, item 4

Status: This is the original version (as it was originally made). This item of legislation is currently only available in its original format.

## PART III

### SIGNS FOR LANE CLOSURES AND CONTRA-FLOW WORKING AT ROAD WORKS

SCHEDULE 12 PART III  
SIGNS FOR LANE CLOSURES AND  
CONTRA-FLOW WORKING AT ROAD WORKS

Regulation 11(1)

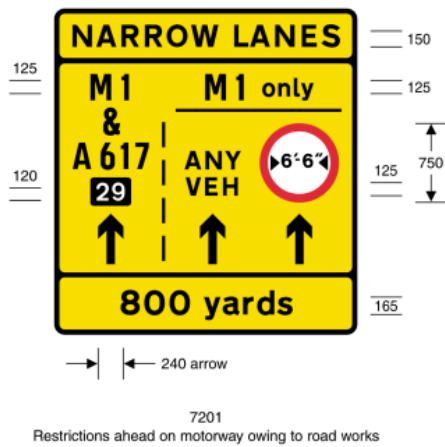

Item	
1	Regulations: 7(2), 17, 54
2	Directions: 7, 36
3	Diagrams: See table of combinations
4	Permitted variants: Schedule 16, items 16, 42, 43, 44 The legend "M1 only" may be varied. "M1 only" and the horizontal bar may be omitted. The vertical broken line may be varied or omitted
5	Illumination requirements: Schedule 17, item 1

Table of combinations

Item 1	Top panel	None	7262	7263	7264
Item 2	Bottom panels	7270 7271 7275 None	7270 7271	7271 None	7271 7275 None

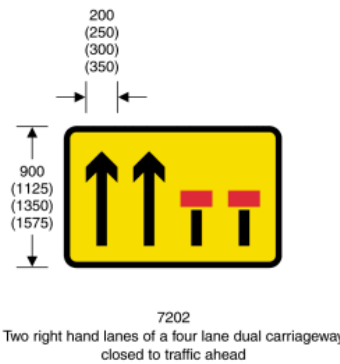
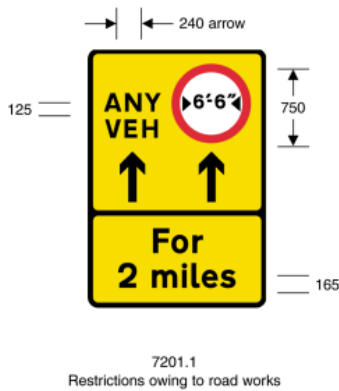

Item	
1	Regulations: None
2	Directions: 7, 36
3	Diagrams: None
4	Permitted variants: Schedule 16, items 6, 16, 42, 45 The panel shown in diagram 7264 may be added to the top of the sign
5	Illumination requirements: Schedule 17, item 1

Item	
1	Regulations: 54
2	Directions: 21(1), 36
3	Diagrams: 7208
4	Permitted variants: Schedule 16, item 16
5	Illumination requirements: Schedule 17, item 1



**Status:** This is the original version (as it was originally made). This item of legislation is currently only available in its original format.

SCHEDULE 12 PART III SIGNS FOR LANE CLOSURES AND CONTRA-FLOW WORKING AT ROAD WORKS (contd.)

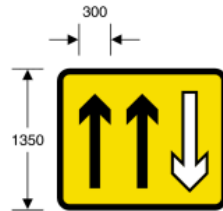

7203  
Two lanes of carriageway open to traffic with off side contra-flow working

Item	
1	Regulations: None
2	Directions: 21(1), 36
3	Diagrams: 7209
4	Permitted variants: Schedule 16, item 16
5	Illumination requirements: Schedule 17, item 1

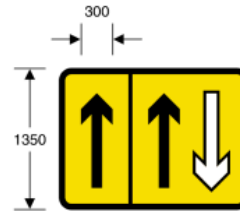

7203.1  
Two lanes open to traffic, one of which uses the hard shoulder, with off side contra-flow working

Item	
1	Regulations: None
2	Directions: 7, 21(1), 36
3	Diagrams: 7209
4	Permitted variants: Schedule 16, item 16
5	Illumination requirements: Schedule 17, item 1

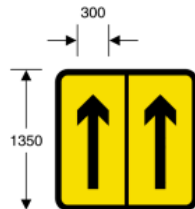

7204  
Two lanes open to traffic, one of which uses the hard shoulder

Item	
1	Regulations: None
2	Directions: 7, 21(1), 36
3	Diagrams: 7209
4	Permitted variants: Schedule 16, item 16
5	Illumination requirements: Schedule 17, item 1

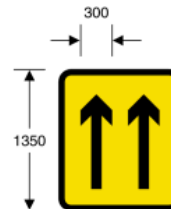

7205  
Two lanes of carriageway open to traffic

Item	
1	Regulations: None
2	Directions: 21(1), 36
3	Diagrams: 7209
4	Permitted variants: Schedule 16, item 16
5	Illumination requirements: Schedule 17, item 1

**Status:** This is the original version (as it was originally made). This item of legislation is currently only available in its original format.

SCHEDULE 12 PART III SIGNS FOR LANE CLOSURES AND CONTRA-FLOW WORKING AT ROAD WORKS (contd.)

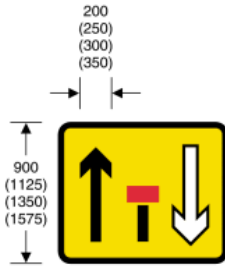

7206  
Centre lane of a three lane single carriageway road closed with traffic on the off side of the works travelling in the opposite direction

Item	
1	Regulations: None
2	Directions: 21(1), 36
3	Diagrams: 7208
4	Permitted variants: Schedule 16, item 16
5	Illumination requirements: Schedule 17, item 1

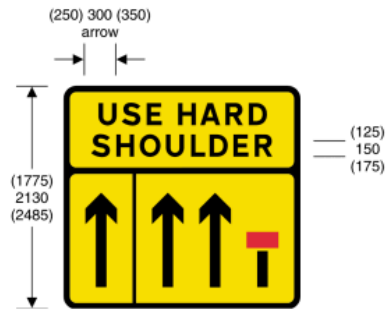

7207  
Right hand lane of a three lane dual carriageway closed ahead; traffic may use left hand lanes and hard shoulder now

Item	
1	Regulations: 54
2	Directions: 7, 21(1), 36
3	Diagrams: 7208 (largest three sizes)
4	Permitted variants: Schedule 16, item 16
5	Illumination requirements: Schedule 17, item 1



7208  
Distance ahead at which conditions indicated by signs shown in the diagrams in item 3 of the table start to apply

Item	
1	Regulations: None
2	Directions: 21(1), 36
3	Diagrams: 7202, 7206, 7207
4	Permitted variants: Schedule 16, item 6 The legend may be on two lines. "On slip road" may be substituted for the distance
5	Illumination requirements: Schedule 17, item 1



7209  
Distance over which conditions indicated by signs shown in the diagrams in item 3 of the table will apply

Item	
1	Regulations: None
2	Directions: 21(1), 36
3	Diagrams: 7203, 7203.1, 7204, 7205
4	Permitted variants: Schedule 16, item 6 The legend may be on one line
5	Illumination requirements: Schedule 17, item 8

**Status:** This is the original version (as it was originally made). This item of legislation is currently only available in its original format.

SCHEDULE 12 PART III SIGNS FOR LANE CLOSURES AND CONTRA-FLOW WORKING AT ROAD WORKS (contd.)

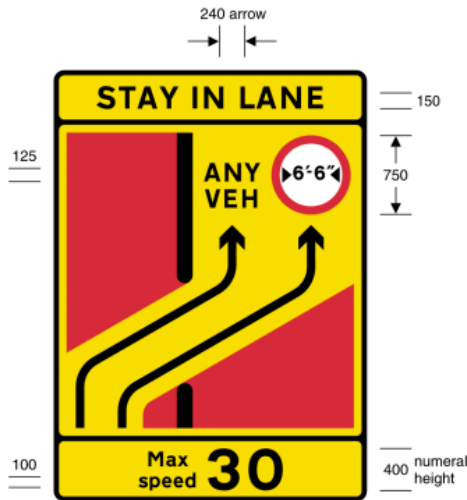

Item	
1	Regulations: 7(2), 17
2	Directions: 7, 36
3	Diagrams: See table of combinations
4	Permitted variants: Schedule 16, items 16, 42, 43
5	Illumination requirements: Schedule 17, item 1

Table of combinations

Item 1	Top panel	None	7263	7264
Item 2	Bottom panels	7271 7275 None	7271 7274 7275 None	7271 7275 None

7210

Diversion of two traffic lanes to the other carriageway, with vehicles over 6'6" wide prohibited from the right hand lane

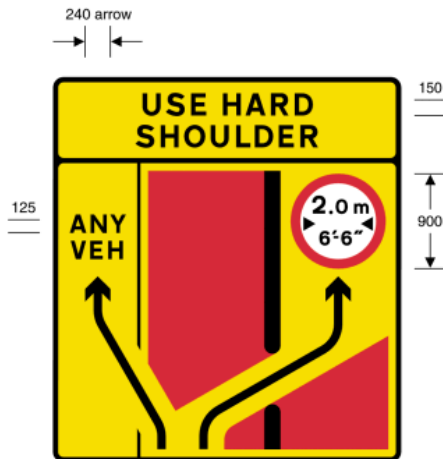

Item	
1	Regulations: 7(2), 17
2	Directions: 7, 36
3	Diagrams: See table of combinations
4	Permitted variants: Schedule 16, items 16, 42, 43
5	Illumination requirements: Schedule 17, item 1

Table of combinations

Item 1	Top panel	None	7260	7262	7263	7264
Item 2	Bottom panels	7271	7272 7274 7275 None	7271	7271	7271

7211.1

Diversion of the two lanes open to traffic; the left hand lane uses the hard shoulder, and the right hand lane which is subject to a width restriction goes to the other carriageway

*Status: This is the original version (as it was originally made). This item of legislation is currently only available in its original format.*

SCHEDULE 12 PART III SIGNS FOR LANE CLOSURES AND CONTRA-FLOW WORKING AT ROAD WORKS (contd.)

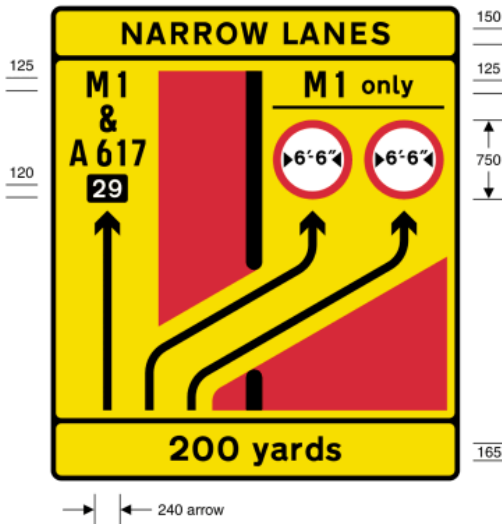

7212  
 Diversion of two right hand lanes of three lanes open to traffic to the other carriageway of a motorway; vehicles over 6'6" wide are prohibited from the two right hand lanes

Item	
1	Regulations: 7(2), 17
2	Directions: 7, 36
3	Diagrams: See table of combinations
4	Permitted variants: Schedule 16, items 16, 42, 43 The legend "M1 only" may be varied. "M1 only" and the horizontal bar may be omitted
5	Illumination requirements: Schedule 17, item 1

Table of combinations

Item 1	Top panel	None	7262	7263	7264
Item 2	Bottom panels	7271 7272 7275 None	7271	7271 7272 7274 7275 None	7271 7272 7275 None

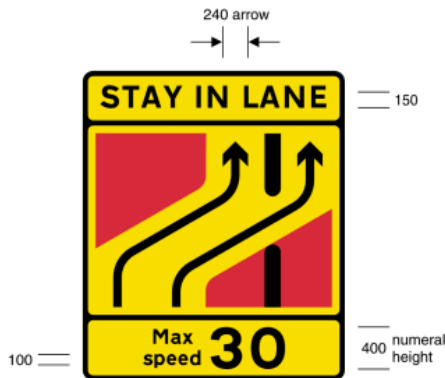

7213  
 Diversion of two lanes open to traffic; the left hand lane moves to the right hand side of the carriageway, and the right hand lane goes to the other carriageway

Item	
1	Regulations: 7(2), 17
2	Directions: 7, 36
3	Diagrams: See table of combinations
4	Permitted variants: Schedule 16, items 16, 42, 43
5	Illumination requirements: Schedule 17, item 1

Table of combinations

Item 1	Top panel	None	7262	7263	7264
Item 2	Bottom panels	7271 7272 7275 None	7271	7271 7272 7274 7275 None	7271 7272 7275 None

**Status:** This is the original version (as it was originally made). This item of legislation is currently only available in its original format.

SCHEDULE 12 PART III SIGNS FOR LANE CLOSURES AND CONTRA-FLOW WORKING AT ROAD WORKS (contd.)



7214  
Diversion of left hand lane from original carriageway to join right hand lane already diverted to the other carriageway

Item	
1	Regulations: 7(2), 17
2	Directions: 7, 36
3	Diagrams: See table of combinations
4	Permitted variants: Schedule 16, items 16, 42, 43
5	Illumination requirements: Schedule 17, item 1

Table of combinations

Item 1	Top panel	None	7263	7264
Item 2	Bottom panels	7271 7272 7275 None	7271 7272 7274 None	7271 7272 7275 None

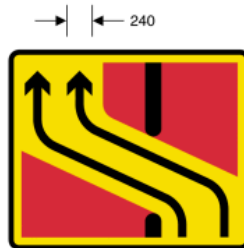

7215  
Two lanes open to traffic return to original carriageway

Item	
1	Regulations: 7(2), 17
2	Directions: 7, 36
3	Diagrams: See table of combinations
4	Permitted variants: Schedule 16, items 16, 42, 43
5	Illumination requirements: Schedule 17, item 1

Table of combinations

Item 1	Top panel	None	7263	7264
Item 2	Bottom panels	7271 7275 None	7271 7274 7275 None	7271 7275 None



7216  
Right hand lane returns to right hand side of original carriageway ahead, but remains separated by works area from left hand lane

Item	
1	Regulations: 7(2), 17
2	Directions: 7, 36
3	Diagrams: See table of combinations
4	Permitted variants: Schedule 16, items 16, 42, 43
5	Illumination requirements: Schedule 17, item 1

Table of combinations

Item 1	Top panel	None	7263	7264
Item 2	Bottom panels	7271 7275 None	7271 7274 7275 None	7271 7275 None

**Status:** This is the original version (as it was originally made). This item of legislation is currently only available in its original format.

SCHEDULE 12 PART III SIGNS FOR LANE CLOSURES AND CONTRA-FLOW WORKING AT ROAD WORKS (contd.)



7217  
Left hand lane returns from right hand side of original carriageway to left hand side ahead and right hand lane returns from other carriageway to right hand side of original carriageway

Item	
1	Regulations: 7(2), 17
2	Directions: 7, 36
3	Diagrams: See table of combinations
4	Permitted variants: Schedule 16, items 16, 42, 43
5	Illumination requirements: Schedule 17, item 1

Table of combinations

Item 1	Top panel	None	7263	7264
Item 2	Bottom panels	7271 7275 None	7271 7274 7275 None	7271 7275 None



7218  
Left hand lane returns from other carriageway to original carriageway ahead; right hand lane continues on other carriageway

Item	
1	Regulations: 7(2), 17
2	Directions: 7, 36
3	Diagrams: See table of combinations
4	Permitted variants: Schedule 16, items 16, 42, 43
5	Illumination requirements: Schedule 17, item 1

Table of combinations

Item 1	Top panel	None	7262	7263	7264
Item 2	Bottom panels	7271 7272 7275 None	7271	7271 7272 7274 7275 None	7271 7272 7275 None

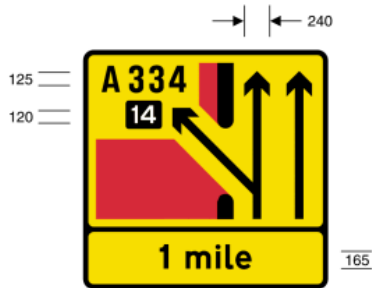

7220  
Destinations reached from a junction where traffic is in contra-flow on other carriageway of a motorway

Item	
1	Regulations: 7(2), 17
2	Directions: 7, 36
3	Diagrams: See table of combinations
4	Permitted variants: Schedule 16, items 16, 42, 43
5	Illumination requirements: Schedule 17, item 1

Table of combinations

Item 1	Top panel	None
Item 2	Bottom panels	7270 7271 None

**Status:** This is the original version (as it was originally made). This item of legislation is currently only available in its original format.

SCHEDULE 12 PART III SIGNS FOR LANE CLOSURES AND CONTRA-FLOW WORKING AT ROAD WORKS (contd.)

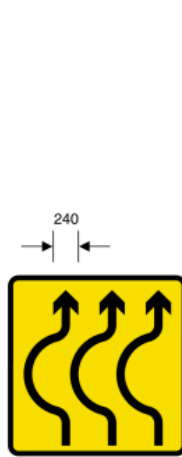

7221  
Sharp bends ahead where traffic is diverted onto a temporary road for a short distance

Item	
1	Regulations: 7(2), 17
2	Directions: 36
3	Diagrams: See table of combinations
4	Permitted variants: Schedule 16, items 16, 28, 42, 43
5	Illumination requirements: Schedule 17, item 1

Table of combinations

Item 1	Top panel	None	7262	7263	7264
Item 2	Bottom panels	7271	7271	7271	7271
		7275		7274	7275
		None		7275	None

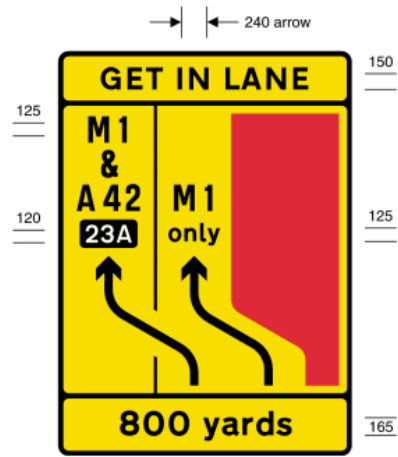

7230  
Diversion of traffic from left and centre lanes of a motorway carriageway to use hard shoulder and left hand lane; hard shoulder is to be used by traffic leaving at the junction specified

Item	
1	Regulations: 7(2), 17
2	Directions: 7, 36
3	Diagrams: See table of combinations
4	Permitted variants: Schedule 16, items 16, 42, 43
5	Illumination requirements: Schedule 17, item 1

Table of combinations

Item 1	Top panel	None	7260	7262	7263	7264
Item 2	Bottom panels	7271	7272	7271	7271	7271
			7274			
			7275			

**Status:** This is the original version (as it was originally made). This item of legislation is currently only available in its original format.

SCHEDULE 12 PART III SIGNS FOR LANE CLOSURES AND CONTRA-FLOW WORKING AT ROAD WORKS (contd.)



7231  
Return of traffic from hard shoulder and left lane of carriageway to left and centre lanes

Item	
1	Regulations: 7(2), 17
2	Directions: 7, 36
3	Diagrams: See table of combinations
4	Permitted variants: Schedule 16, items 16, 42, 43
5	Illumination requirements: Schedule 17, item 1

Table of combinations

Item 1	Top panel	None	7261	7262	7263	7264
Item 2	Bottom panels	7271	7272 7274 7275 None	7271	7271	7271

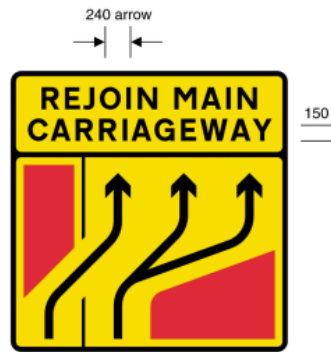

7232  
Return of traffic from hard shoulder and left lane of carriageway to use three lanes

Item	
1	Regulations: 7(2), 17
2	Directions: 7, 36
3	Diagrams: See table of combinations
4	Permitted variants: Schedule 16, items 16, 42, 43
5	Illumination requirements: Schedule 17, item 1

Table of combinations

Item 1	Top panel	None	7261
Item 2	Bottom panels	7271	7272 7275 None



**Status:** This is the original version (as it was originally made). This item of legislation is currently only available in its original format.

SCHEDULE 12 PART III SIGNS FOR LANE CLOSURES AND CONTRA-FLOW WORKING AT ROAD WORKS (contd.)

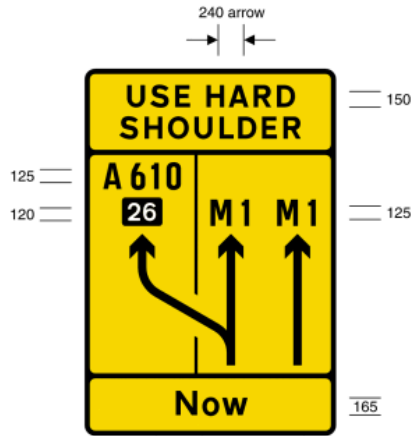

7233  
Traffic from left hand lane of carriageway of a motorway to use hard shoulder to leave at junction ahead

Item	
1	Regulations: 7(2), 17
2	Directions: 7, 36
3	Diagrams: See table of combinations
4	Permitted variants: Schedule 16, Items 16, 42, 43
5	Illumination requirements: Schedule 17, item 1

Table of combinations

Item 1	Top panel	None	7260
Item 2	Bottom panels	7271	7272 None

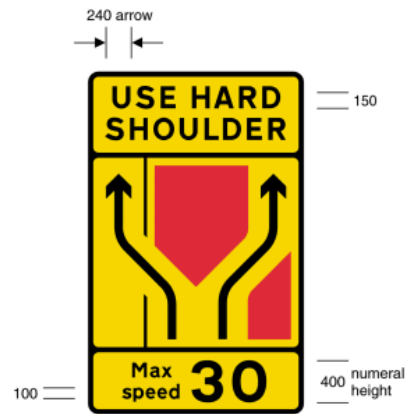

7234  
Traffic from left hand lane to use hard shoulder ahead; traffic from centre lane to move to right hand side of carriageway

Item	
1	Regulations: 7(2), 17
2	Directions: 7, 36
3	Diagrams: See table of combinations
4	Permitted variants: Schedule 16, items 16, 42, 43
5	Illumination requirements: Schedule 17, item 1

Table of combinations

Item 1	Top panel	None	7260	7262	7263	7264
Item 2	Bottom panels	7271	7272 7274 7275 None	7271	7271	7271

**Status:** This is the original version (as it was originally made). This item of legislation is currently only available in its original format.

SCHEDULE 12 PART III SIGNS FOR LANE CLOSURES AND CONTRA-FLOW WORKING AT ROAD WORKS (contd.)

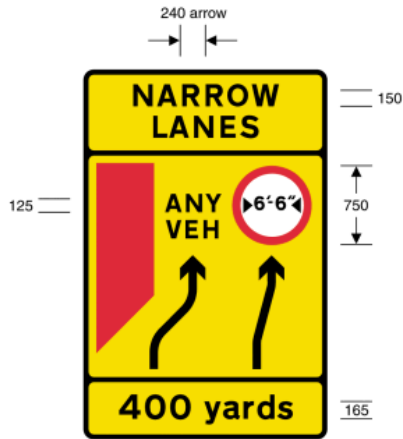

7235  
Lanes ahead are narrower than normal; wide vehicles are prohibited from the right hand lane

Item	
1	Regulations: 7(2), 17
2	Directions: 7, 36
3	Diagrams: See table of combinations
4	Permitted variants: Schedule 16, items 16, 42, 43
5	Illumination requirements: Schedule 17, item 1

Table of combinations

Item 1	Top panel	7264
Item 2	Bottom panels	7271 None

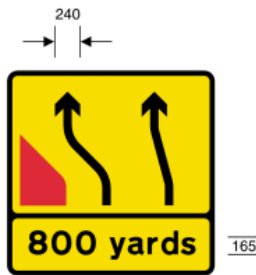

7236  
Lanes return to normal width

Item	
1	Regulations: 7(2), 17
2	Directions: 36
3	Diagrams: See table of combinations
4	Permitted variants: Schedule 16, items 16, 42, 43
5	Illumination requirements: Schedule 17, item 1

Table of combinations

Item 1	Top panel	None
Item 2	Bottom panels	7271 None

**Status:** This is the original version (as it was originally made). This item of legislation is currently only available in its original format.

SCHEDULE 12 PART III SIGNS FOR LANE CLOSURES AND CONTRA-FLOW WORKING AT ROAD WORKS (contd.)



7237  
Diversion of traffic from left and centre lanes to centre and right hand lanes

Item	
1	Regulations: 7(2), 17
2	Directions: 36
3	Diagrams: See table of combinations
4	Permitted variants: Schedule 16, items 16, 42, 43
5	Illumination requirements: Schedule 17, item 1

Table of combinations

Item 1	Top panel	None	7263	7264
Item 2	Bottom panels	7271 7275 None	7271 7274 7275 None	7271 7275 None



7238  
Diversion of traffic from centre lane to right hand lane; traffic in left hand lane is unaffected

Item	
1	Regulations: 7(2), 17
2	Directions: 36
3	Diagrams: See table of combinations
4	Permitted variants: Schedule 16, items 16, 42, 43
5	Illumination requirements: Schedule 17, item 1

Table of combinations

Item 1	Top panel	None	7262	7263	7264
Item 2	Bottom panels	7271 7272 7275 None	7271	7271 7272 7274 7275 None	7271 7272 7275 None



7239  
Traffic diverted from right hand lane to rejoin centre lane

Item	
1	Regulations: 7(2), 17
2	Directions: 36
3	Diagrams: See table of combinations
4	Permitted variants: Schedule 16, items 16, 42, 43
5	Illumination requirements: Schedule 17, item 1

Table of combinations

Item 1	Top panel	None	7263	7264
Item 2	Bottom panels	7271 7272 7275 None	7271 7272 7274 7275 None	7271 7272 7275 None

**Status:** This is the original version (as it was originally made). This item of legislation is currently only available in its original format.

SCHEDULE 12 PART III SIGNS FOR LANE CLOSURES AND CONTRA-FLOW WORKING AT ROAD WORKS (contd.)

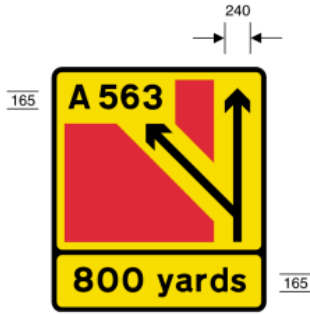

7240  
Destination reached from a junction where permanent sign is obscured by presence of road works on an all-purpose road

Item	
1	Regulations: 7(2), 17
2	Directions: 36
3	Diagrams: See table of combinations
4	Permitted variants: Schedule 16, items 16, 42, 43
5	Illumination requirements: Schedule 17, item 1

Table of combinations

Item 1	Top panel	None
Item 2	Bottom panels	7270 7271 None



7241  
Number of route reached from a motorway exit road during road works

Item	
1	Regulations: None
2	Directions: 14(1), 36
3	Diagrams: None
4	Permitted variants: Schedule 16, items 19, 20 The arrow may be positioned in the manner shown in diagram 7242
5	Illumination requirements: Schedule 17, item 1



7242  
Number of route reached from a road junction during road works

Item	
1	Regulations: None
2	Directions: 13(3), 36
3	Diagrams: None
4	Permitted variants: Schedule 16, items 19, 20 The arrow may be positioned in the manner shown in diagram 7241
5	Illumination requirements: Schedule 17, item 1

**Status:** This is the original version (as it was originally made). This item of legislation is currently only available in its original format.

SCHEDULE 12 PART III SIGNS FOR LANE CLOSURES AND CONTRA-FLOW WORKING AT ROAD WORKS (contd.)

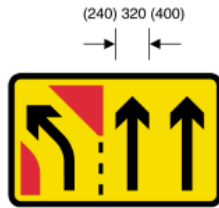

7250  
Near side traffic lane diverges from main carriageway at a junction as part of temporary traffic management scheme

Item	
1	Regulations: None
2	Directions: 21(1), 36
3	Diagrams: 7256
4	Permitted variants: Schedule 16, item 16
5	Illumination requirements: Schedule 17, item 1



7251  
Additional traffic lanes joining from the right at a junction as part of temporary traffic management scheme

Item	
1	Regulations: None
2	Directions: 21(1), 36
3	Diagrams: 7256
4	Permitted variants: Schedule 16, item 16
5	Illumination requirements: Schedule 17, item 1



7252  
Traffic joining from the left at a junction as part of temporary traffic management scheme; traffic on the main carriageway has priority

Item	
1	Regulations: None
2	Directions: 21(1), 36
3	Diagrams: 7256
4	Permitted variants: Schedule 16, item 16
5	Illumination requirements: Schedule 17, item 1

**Status:** This is the original version (as it was originally made). This item of legislation is currently only available in its original format.

SCHEDULE 12 PART III SIGNS FOR LANE CLOSURES AND CONTRA-FLOW WORKING AT ROAD WORKS (contd.)



7253  
Traffic joining main carriageway at a junction as part of temporary traffic management scheme; traffic on the main carriageway has priority

Item	
1	Regulations: None
2	Directions: 21(1), 36
3	Diagrams: 7256
4	Permitted variants: Schedule 16, item 16
5	Illumination requirements: Schedule 17, item 1

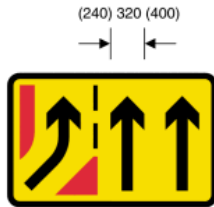

7254  
Additional traffic lane joining from the left at a junction as part of temporary traffic management scheme

Item	
1	Regulations: None
2	Directions: 21(1), 36
3	Diagrams: 7256
4	Permitted variants: Schedule 16, item 16
5	Illumination requirements: Schedule 17, item 1

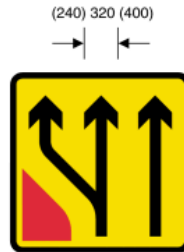

7255  
Additional traffic lane available ahead as part of temporary traffic management scheme

Item	
1	Regulations: None
2	Directions: 21(1), 36
3	Diagrams: 7256
4	Permitted variants: Schedule 16, item 16
5	Illumination requirements: Schedule 17, item 1

**Status:** This is the original version (as it was originally made). This item of legislation is currently only available in its original format.

SCHEDULE 12 PART III SIGNS FOR LANE CLOSURES AND CONTRA-FLOW WORKING AT ROAD WORKS (contd.)



7256  
Distance ahead at which the change in road layout occurs

Item	
1	Regulations: None)
2	Directions: 21(1), 36
3	Diagrams: 7250, 7251, 7252, 7253, 7254, 7255
4	Permitted variants: Schedule 16, item 6
5	Illumination requirements: Schedule 17, item 1



7260  
Panel to appear at top of road works sign allowing traffic to use hard shoulder as indicated on main part of sign

Item	
1	Regulations: 17
2	Directions: 7, 36
3	Diagrams: 7211.1, 7230, 7233, 7234
4	Permitted variants: The legend may be on one line
5	Illumination requirements: Schedule 17, item 1



7261  
Panel to appear at top of road works sign instructing traffic using hard shoulder to rejoin main carriageway

Item	
1	Regulations: 17
2	Directions: 7, 36
3	Diagrams: 7231, 7232
4	Permitted variants: The legend may be on one line
5	Illumination requirements: Schedule 17, item 1



7262  
Panel to appear at top of road works sign instructing traffic to get into the appropriate lane as indicated on main part of sign

Item	
1	Regulations: 17
2	Directions: 36
3	Diagrams: 7201, 7211.1, 7212, 7213, 7218, 7221, 7230, 7231, 7234, 7238
4	Permitted variants: The legend may be on two lines
5	Illumination requirements: Schedule 17, item 1

**Status:** This is the original version (as it was originally made). This item of legislation is currently only available in its original format.

SCHEDULE 12 PART III SIGNS FOR LANE CLOSURES AND CONTRA-FLOW WORKING AT ROAD WORKS (contd.)



7263  
Panel to appear at top of road works sign instructing traffic to remain in appropriate lane

Item	
1	Regulations: 17
2	Directions: 36
3	Diagrams: 7201, 7210, 7211.1, 7212, 7213, 7214, 7215, 7216, 7217, 7218, 7221, 7230, 7231, 7234, 7237, 7238, 7239
4	Permitted variants: The legend may be on one line
5	Illumination requirements: Schedule 17, item 1



7264  
Panel to appear at top of road works sign indicating that traffic lanes are narrower than normal

Item	
1	Regulations: 17
2	Directions: 36
3	Diagrams: 7201, 7201.1, 7210, 7211.1, 7212, 7213, 7214, 7215, 7216, 7217, 7218, 7221, 7230, 7231, 7234, 7235, 7237, 7238, 7239
4	Permitted variants: The legend may be on one line
5	Illumination requirements: Schedule 17, item 1



7270  
Panel to appear at bottom of road works sign indicating distance in miles to junction indicated on signs shown in diagrams in item 3 of the table

Item	
1	Regulations: 17
2	Directions: 36
3	Diagrams: 7201, 7220, 7240
4	Permitted variants: "1 mile" may be varied to "2/3 mile"
5	Illumination requirements: Schedule 17, item 1



7271  
Panel to appear at bottom of road works sign indicating distance in yards to point at which condition indicated by signs shown in diagrams in item 3 of the table start to apply

Item	
1	Regulations: 17
2	Directions: 36
3	Diagrams: 7201, 7210, 7211.1, 7212, 7213, 7214, 7215, 7216, 7217, 7218, 7220, 7221, 7230, 7231, 7232, 7233, 7234, 7235, 7236, 7237, 7238, 7239, 7240
4	Permitted variants: "200" may be varied to the appropriate distance to the nearest 50 yards. The legend may be on two lines. "yards" may be varied to "yds"
5	Illumination requirements: Schedule 17, item 1



**Status:** This is the original version (as it was originally made). This item of legislation is currently only available in its original format.

SCHEDULE 12 PART III SIGNS FOR LANE CLOSURES AND CONTRA-FLOW WORKING AT ROAD WORKS (contd.)



7272  
Panel to appear at bottom of road works sign indicating that the change to the road layout indicated by signs shown in diagrams in item 3 of the table occurs at that point

Item	
1	Regulations: 17
2	Directions: 36
3	Diagrams: 7211.1, 7212, 7213, 7214, 7218, 7230, 7231, 7232, 7233, 7234, 7238, 7239
4	Permitted variants: None
5	Illumination requirements: Schedule 17, item 1



7274  
Panel to appear at bottom of road works sign indicating that traffic lanes are narrower than normal

Item	
1	Regulations: 17
2	Directions: 36
3	Diagrams: 7210, 7211.1, 7212, 7213, 7214, 7215, 7216, 7217, 7218, 7221, 7230, 7231, 7234, 7237, 7238, 7239
4	Permitted variants: The legend may be on one line
5	Illumination requirements: Schedule 17, item 1



7275  
Panel to appear at bottom of road works sign indicating temporary maximum speed in miles per hour advised

Item	
1	Regulations: 17
2	Directions: 36
3	Diagrams: 7201, 7210, 7211.1, 7212, 7213, 7214, 7215, 7216, 7217, 7218, 7221, 7230, 7231, 7232, 7234, 7237, 7238, 7239
4	Permitted variants: Schedule 16, item 1
5	Illumination requirements: Schedule 17, item 1

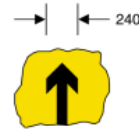

7280  
Symbol that may be incorporated into a road works sign to indicate a lane open to traffic

Item	
1	Regulations: None
2	Directions: 36
3	Diagrams: 7201, 7201.1, 7210, 7211.1, 7212, 7213, 7214, 7215, 7216, 7217, 7218, 7220, 7221, 7230, 7231, 7232, 7233, 7234, 7235, 7236, 7237, 7238, 7239, 7240
4	Permitted variants: None
5	Illumination requirements: Not applicable

**Status:** This is the original version (as it was originally made). This item of legislation is currently only available in its original format.

SCHEDULE 12 PART III SIGNS FOR LANE CLOSURES AND CONTRA-FLOW WORKING AT ROAD WORKS (contd.)

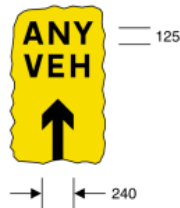

7281

Symbol that may be incorporated into a road works sign to indicate a lane open to any vehicle

Item	
1	Regulations: None
2	Directions: 36
3	Diagrams: Same as 7280
4	Permitted variants: None
5	Illumination requirements: Not applicable



7282

Symbol that may be incorporated into a road works sign to indicate a lane subject to a temporary prohibition on goods vehicles exceeding the maximum gross weight shown

Item	
1	Regulations: None
2	Directions: 7, 36
3	Diagrams: Same as 7280
4	Permitted variants: Same as diagram 622.1A. The size of the sign to diagram 622.1A shall be increased to 900 mm diameter when used in conjunction with diagram 7283.1 or 7284.1
5	Illumination requirements: Not applicable

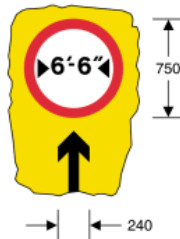

7283

Symbol that may be incorporated into a road works sign to indicate a lane subject to a temporary width restriction

Item	
1	Regulations: None
2	Directions: 7, 36
3	Diagrams: Same as 7280
4	Permitted variants: Schedule 16, item 1
5	Illumination requirements: Not applicable



7283.1

As diagram 7283, with width indicated in both metric and imperial units

Item	
1	Regulations: None
2	Directions: 7, 36
3	Diagrams: Same as 7280
4	Permitted variants: Schedule 16, item 1
5	Illumination requirements: Not applicable

**Status:** This is the original version (as it was originally made). This item of legislation is currently only available in its original format.

SCHEDULE 12 PART III SIGNS FOR LANE CLOSURES AND CONTRA-FLOW WORKING AT ROAD WORKS (contd.)



7284

Symbol that may be incorporated into a road works sign to indicate a lane subject to a temporary height restriction

Item	
1	Regulations: None
2	Directions: 7, 36
3	Diagrams: Same as 7280
4	Permitted variants: Schedule 16, item 1
5	Illumination requirements: Not applicable

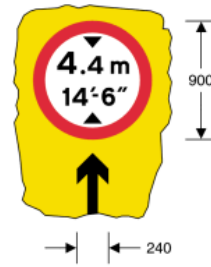

7284.1

As diagram 7284, with height indicated in both metric and imperial units

Item	
1	Regulations: None
2	Directions: 7, 36
3	Diagrams: Same as 7280
4	Permitted variants: Schedule 16, item 1
5	Illumination requirements: Not applicable



7285

Symbol that may be incorporated into a road works sign on an all-purpose road to indicate that a lane leads to a particular destination

Item	
1	Regulations: None
2	Directions: 13(3), 36
3	Diagrams: 7201, 7210, 7211.1, 7212, 7213, 7214, 7215, 7216, 7217, 7218, 7220, 7221, 7230, 7231, 7232, 7233, 7234, 7235, 7236, 7237, 7238, 7239, 7240
4	Permitted variants: Schedule 16, items 19, 20 The angle of the arrow may be varied to point 45° upwards to the left
5	Illumination requirements: Not applicable

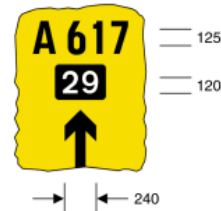

7286

Symbol that may be incorporated into a road works sign on a motorway to indicate that a lane leads to a particular destination at the junction shown

Item	
1	Regulations: None
2	Directions: 14(1), 36
3	Diagrams: Same as 7285
4	Permitted variants: Schedule 16, items 19, 20 Same as diagram 7285
5	Illumination requirements: Not applicable

**Status:** This is the original version (as it was originally made). This item of legislation is currently only available in its original format.

SCHEDULE 12 PART III SIGNS FOR LANE CLOSURES AND CONTRA-FLOW WORKING AT ROAD WORKS (contd.)



7287

Symbol that may be incorporated into a road works sign to indicate that a lane is closed

Item	
1	Regulations: None
2	Directions: 36
3	Diagrams: 7201
4	Permitted variants: None
5	Illumination requirements: Not applicable

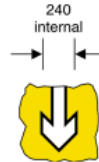

7288

Symbol that may be incorporated into a road works sign to indicate that traffic is moving in the opposite direction to traffic in other lanes which are segregated by traffic cylinders of the type shown in diagram 7103

Item	
1	Regulations: None
2	Directions: 36
3	Diagrams: 7201.1
4	Permitted variants: None
5	Illumination requirements: Not applicable



7290

Mandatory speed limit ahead at road works

Item	
1	Regulations: None
2	Directions: 7, 36
3	Diagrams: None
4	Permitted variants: Schedule 16, item 1
5	Illumination requirements: Schedule 17, item 1



7291

Information on breakdown recovery services during road works

Item	
1	Regulations: None
2	Directions: 36
3	Diagrams: None
4	Permitted variants: "Await rescue" may be varied to "End"
5	Illumination requirements: Schedule 17, item 1

**Status:** This is the original version (as it was originally made). This item of legislation is currently only available in its original format.

SCHEDULE 12 PART III SIGNS FOR LANE CLOSURES AND CONTRA-FLOW WORKING AT ROAD WORKS (contd.)



7292  
Instructions to drivers of wide loads on action to be taken before reaching road works ahead

Item	
1	Regulations: None
2	Directions: 36
3	Diagrams: None
4	Permitted variants: Schedule 16, item 1 "Follow diversion at next exit" may be varied to "Contact police from emergency phone" or "Straddle nearside two lanes"
5	Illumination requirements: Schedule 17, item 1



7293  
Instructions to drivers of wide loads on location from which they should telephone for assistance

Item	
1	Regulations: None
2	Directions: 36
3	Diagrams: None
4	Permitted variants: None
5	Illumination requirements: Schedule 17, item 1



7294  
Temporary maximum speed in miles per hour advised

Item	
1	Regulations: None
2	Directions: 36
3	Diagrams: None
4	Permitted variants: Schedule 16, item 1
5	Illumination requirements: Schedule 17, item 1

**Status:** This is the original version (as it was originally made). This item of legislation is currently only available in its original format.

## PART IV

### SIGNS FOR ROAD WORKS ENTRANCES AND EXITS

SCHEDULE 12 PART IV  
SIGNS FOR ROAD WORKS ENTRANCES AND EXITS

Regulation 11(1)



7301  
Temporary access to a construction or road works site

Item	
1	Regulations: None
2	Directions: 36
3	Diagrams: 506.1
4	Permitted variants: "WORKS ACCESS" may be varied to "WORKS TRAFFIC ONLY" or "NO WORKS TRAFFIC"
5	Illumination requirements: Schedule 17, item 4



7302  
Temporary exit from a construction or road works site

Item	
1	Regulations: None
2	Directions: 36
3	Diagrams: 506.1
4	Permitted variants: None
5	Illumination requirements: Schedule 17, item 4



7303  
Direction to be taken by road works or construction traffic at a junction ahead

Item	
1	Regulations: None
2	Directions: 36
3	Diagrams: None
4	Permitted variants: Schedule 16, item 12
5	Illumination requirements: Schedule 17, item 4

**Status:** This is the original version (as it was originally made). This item of legislation is currently only available in its original format.

SCHEDULE 12 PART IV SIGNS FOR ROAD WORKS ENTRANCES AND EXITS (contd.)



7304  
Direction to be taken by road works or construction traffic at a junction or works entrance ahead

Item	
1	Regulations: None
2	Directions: 36
3	Diagrams: None
4	Permitted variants: Schedule 16, item 12
5	Illumination requirements: Schedule 17, item 4



7305  
Direction to be taken by road works or construction traffic at a junction or works entrance

Item	
1	Regulations: None
2	Directions: 36
3	Diagrams: None
4	Permitted variants: Schedule 16, item 15
5	Illumination requirements: Schedule 17, item 4



7306  
Direction to be taken by road works or construction traffic to an access to a works site ahead

Item	
1	Regulations: None
2	Directions: 36
3	Diagrams: None
4	Permitted variants: Schedule 16, items 6, 16
5	Illumination requirements: Schedule 17, item 4



7307  
Exit from a works site ahead

Item	
1	Regulations: None
2	Directions: 36
3	Diagrams: None
4	Permitted variants: Schedule 16, item 6
5	Illumination requirements: Schedule 17, item 4

**Status:** This is the original version (as it was originally made). This item of legislation is currently only available in its original format.

## PART V

### SIGNS MOUNTED ON ROAD WORKS VEHICLES

#### SCHEDULE 12 PART V SIGNS MOUNTED ON ROAD WORKS VEHICLES

Regulation 11(1)

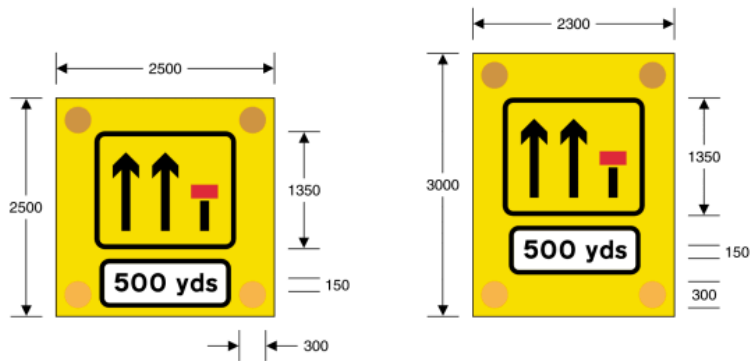

7402  
Lanes closed to traffic ahead by vehicles  
carrying out mobile road works  
(Alternative types)

Item	
1	Regulations: 14
2	Directions: 36
3	Diagrams: None
4	Permitted variants: Schedule 16, item 16 "500 yds" may be varied to an alternative distance to the nearest 50 yards, to "Ahead" or, on the sign shown in the right hand diagram, to "On slip road" on two lines. The distance plate may be omitted
5	Illumination requirements: Schedule 17, item 4



**Status:** This is the original version (as it was originally made). This item of legislation is currently only available in its original format.

SCHEDULE 12 PART V SIGNS MOUNTED ON ROAD WORKS VEHICLES (contd.)

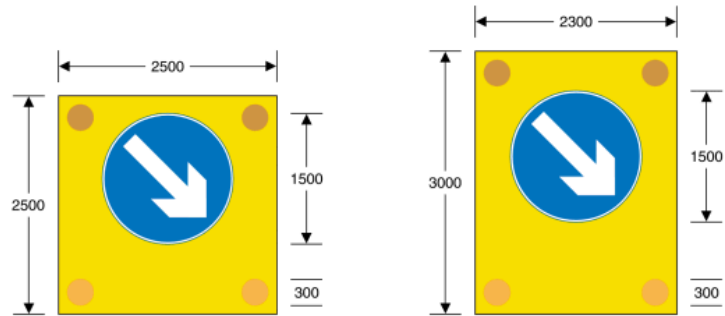

7403  
Other traffic to keep to the right of vehicles carrying out mobile road works (Alternative types)

Item	
1	Regulations: 10(1), 14, 26(6)
2	Directions: 36
3	Diagrams: None
4	Permitted variants: Arrow may point downwards to the left
5	Illumination requirements: Schedule 17, item 4



7404  
Nature of work being done by vehicle working on the highway

Item	
1	Regulations: 14(1)
2	Directions: 36
3	Diagrams: None
4	Permitted variants: "HIGHWAY" may be varied to "MOTORWAY" or "ROAD". The legend may be on one line
5	Illumination requirements: Schedule 17, item 9

*Status:* This is the original version (as it was originally made). This item of legislation is currently only available in its original format.

SCHEDULE 13

PROPORTIONS AND FORM OF LETTERS, NUMERALS AND OTHER CHARACTERS

PART I

PROPORTIONS AND FORM OF LETTERS,  
NUMERALS AND OTHER CHARACTERS

SCHEDULE 13 PART I

Regulations 13(1), 13(5), 13(8)

PROPORTIONS AND FORM OF LETTERS, NUMERALS AND OTHER CHARACTERS

(for use on a sign or parts of a sign with a red, blue, brown, black or green background and on the signs shown in diagrams 2714 and 2715 where the characters in those diagrams are not varied to black)

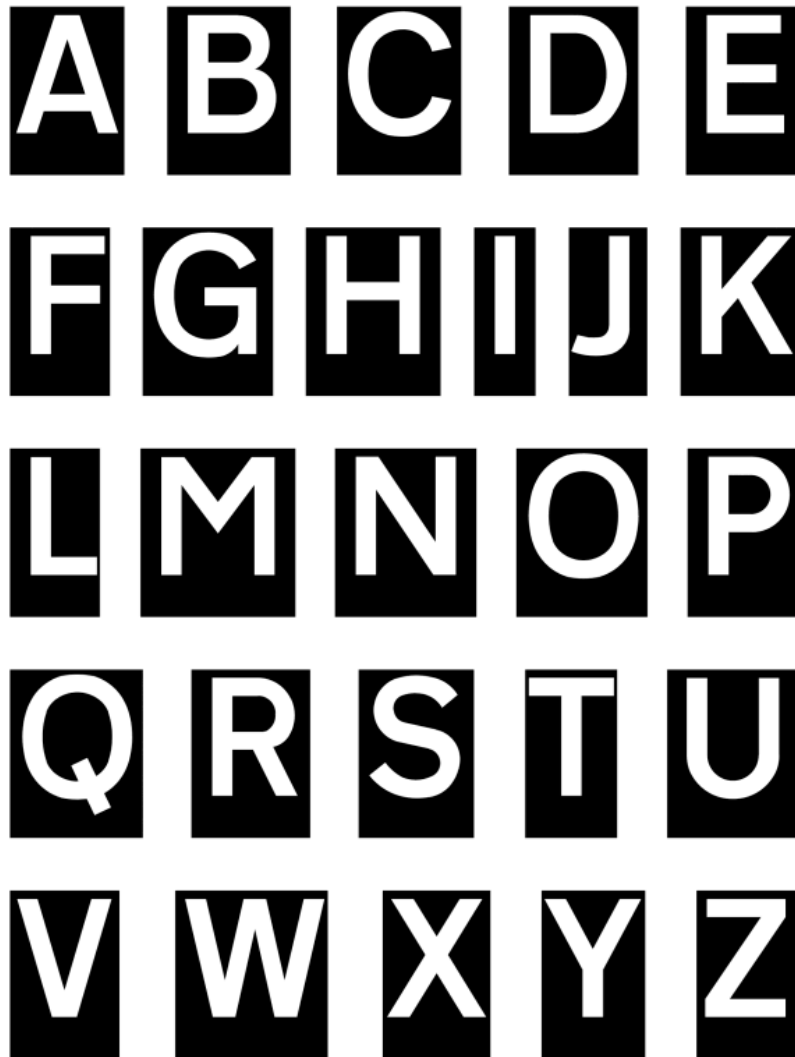

**Status:** This is the original version (as it was originally made). This item of legislation is currently only available in its original format.

SCHEDULE 13 PART I PROPORTIONS AND FORM OF LETTERS, NUMERALS  
AND OTHER CHARACTERS (contd.)

(for use on a sign or parts of a sign with a red, blue, brown, black or green background and on the signs shown in diagrams 2714 and 2715 where the characters in those diagrams are not varied to black)

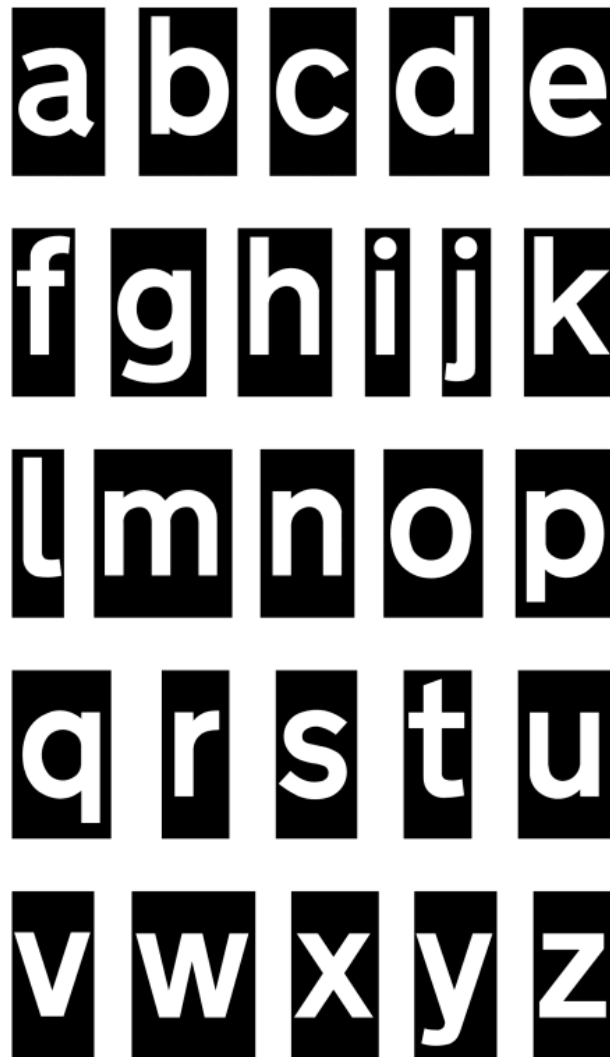

**Status:** This is the original version (as it was originally made). This item of legislation is currently only available in its original format.

SCHEDULE 13 PART I PROPORTIONS AND FORM OF LETTERS, NUMERALS AND OTHER CHARACTERS (contd.)

(for use on a sign or parts of a sign with a red, blue, brown, black or green background and on the signs shown in diagrams 2714 and 2715 where the characters in those diagrams are not varied to black)

**1 2 3 4**

**5 6 7 8**

**9 0**

**1<sub>4</sub> 1<sub>2</sub> 3<sub>4</sub>**

**1<sub>3</sub> 2<sub>3</sub>**

**Status:** This is the original version (as it was originally made). This item of legislation is currently only available in its original format.

SCHEDULE 13 PART I PROPORTIONS AND FORM OF LETTERS, NUMERALS  
AND OTHER CHARACTERS (contd.)

(for use on a sign or parts of a sign with a red, blue, brown, black or green background and on the signs shown in diagrams 2714 and 2715 where the characters in those diagrams are not varied to black)

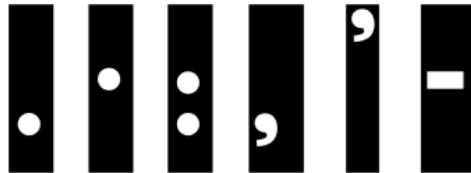
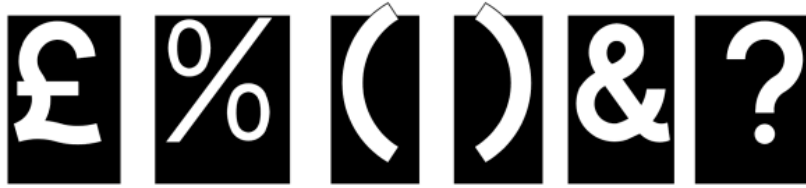

*Status: This is the original version (as it was originally made). This item of legislation is currently only available in its original format.*

**PART II**  
**PROPORTIONS AND FORM OF LETTERS,  
NUMERALS AND OTHER CHARACTERS**

SCHEDULE 13 PART II

Regulations 13(3), 13(8)

PROPORTIONS AND FORM OF LETTERS, NUMERALS AND OTHER CHARACTERS

(for use on a sign or parts of a sign with a white, yellow, or orange background other than the signs shown in diagrams 2714 and 2715 except where the characters in those diagrams are varied to black)

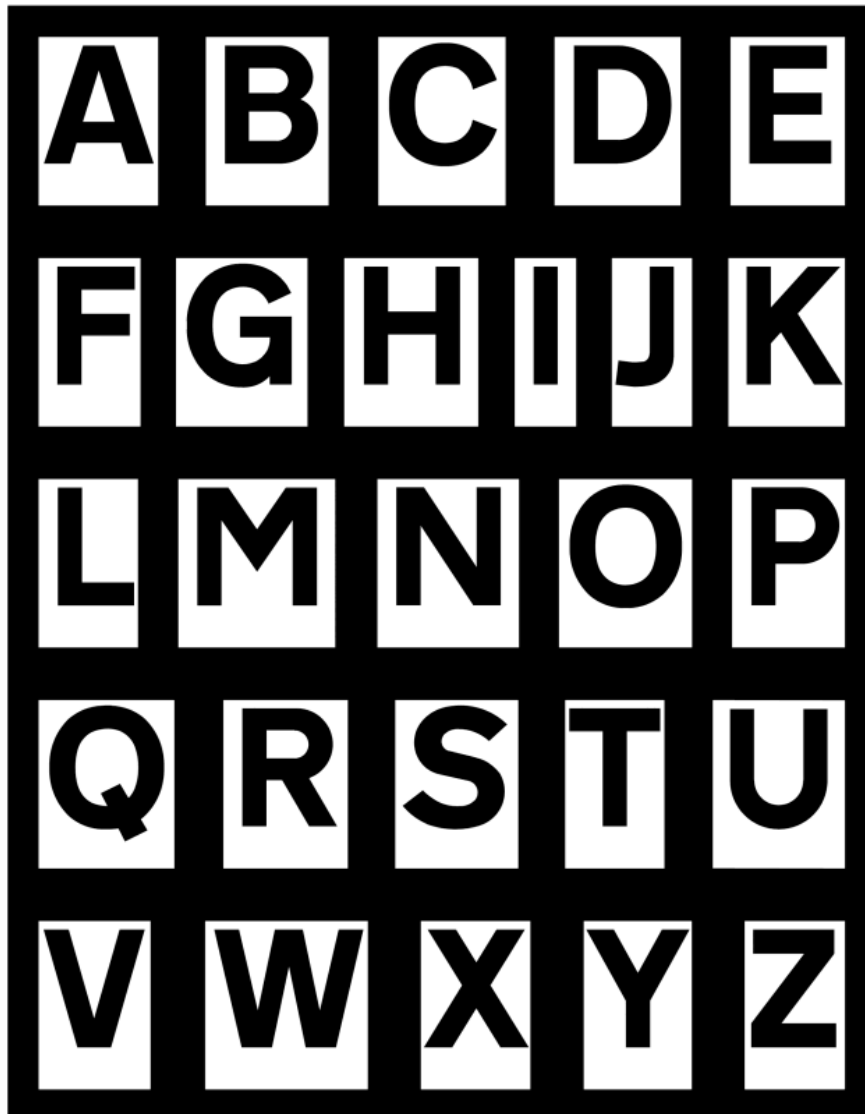

**Status:** This is the original version (as it was originally made). This item of legislation is currently only available in its original format.

SCHEDULE 13 PART II PROPORTIONS AND FORM OF LETTERS, NUMERALS  
AND OTHER CHARACTERS (contd.)

(for use on a sign or parts of a sign with a white, yellow, or orange background other than the signs shown in diagrams 2714 and 2715 except where the characters in those diagrams are varied to black)



**Status:** This is the original version (as it was originally made). This item of legislation is currently only available in its original format.

SCHEDULE 13 PART II PROPORTIONS AND FORM OF LETTERS, NUMERALS AND OTHER CHARACTERS (contd.)

(for use on a sign or parts of a sign with a white, yellow, or orange background other than the signs shown in diagrams 2714 and 2715 except where the characters in those diagrams are varied to black)

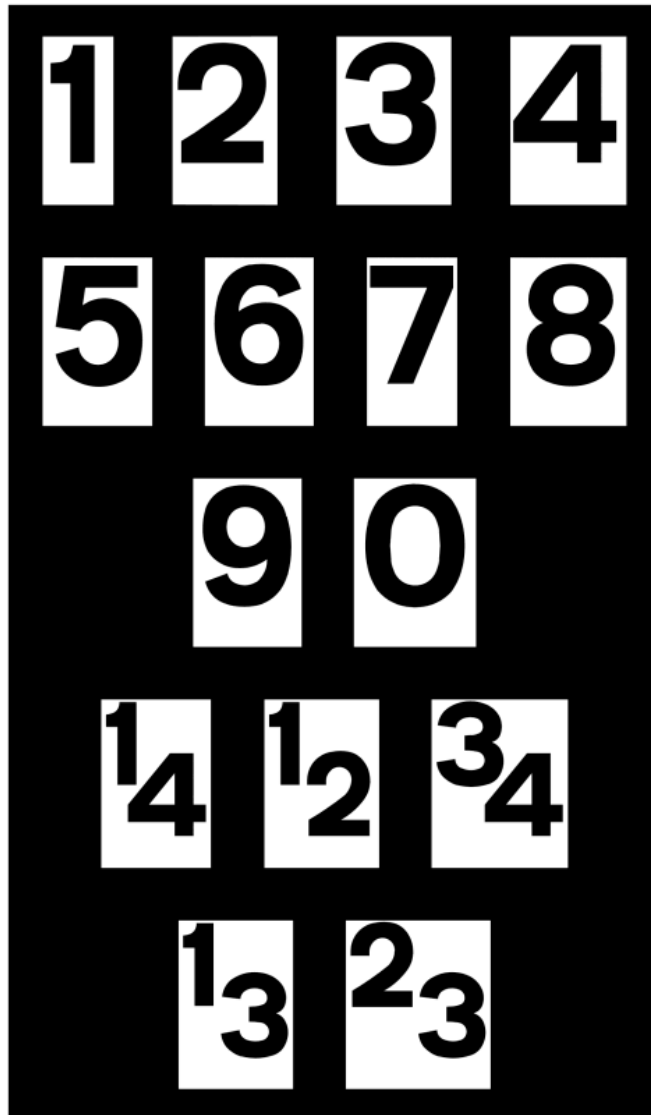



**Status:** This is the original version (as it was originally made). This item of legislation is currently only available in its original format.

SCHEDULE 13 PART II PROPORTIONS AND FORM OF LETTERS, NUMERALS  
AND OTHER CHARACTERS (contd.)

(for use on a sign or parts of a sign with a white, yellow, or orange background other than the signs shown in diagrams 2714 and 2715 except where the characters in those diagrams are varied to black)

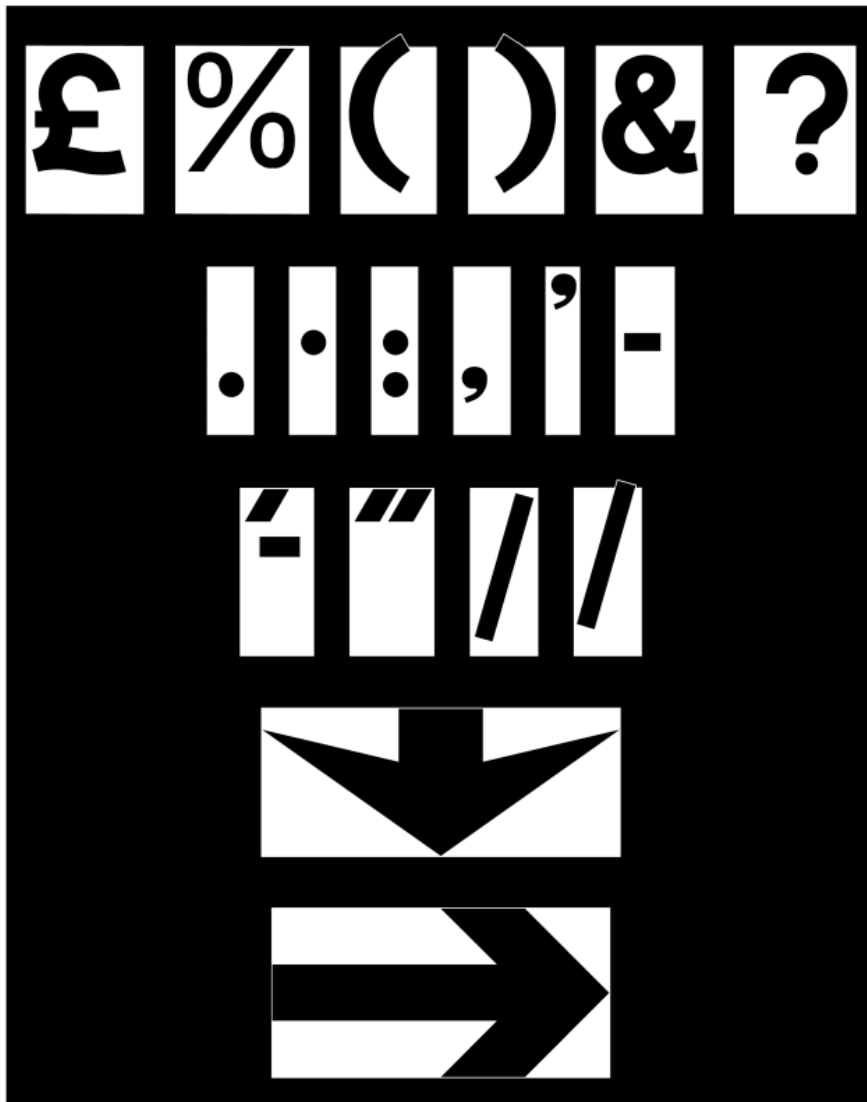

*Status:* This is the original version (as it was originally made). This item of legislation is currently only available in its original format.

### PART III

## PROPORTIONS AND FORM OF LETTERS, NUMERALS AND OTHER CHARACTERS

SCHEDULE 13 PART III

Regulation 13(5)

PROPORTIONS AND FORM OF LETTERS, NUMERALS AND OTHER CHARACTERS  
(for route numbers on permanent motorway signs with blue backgrounds)

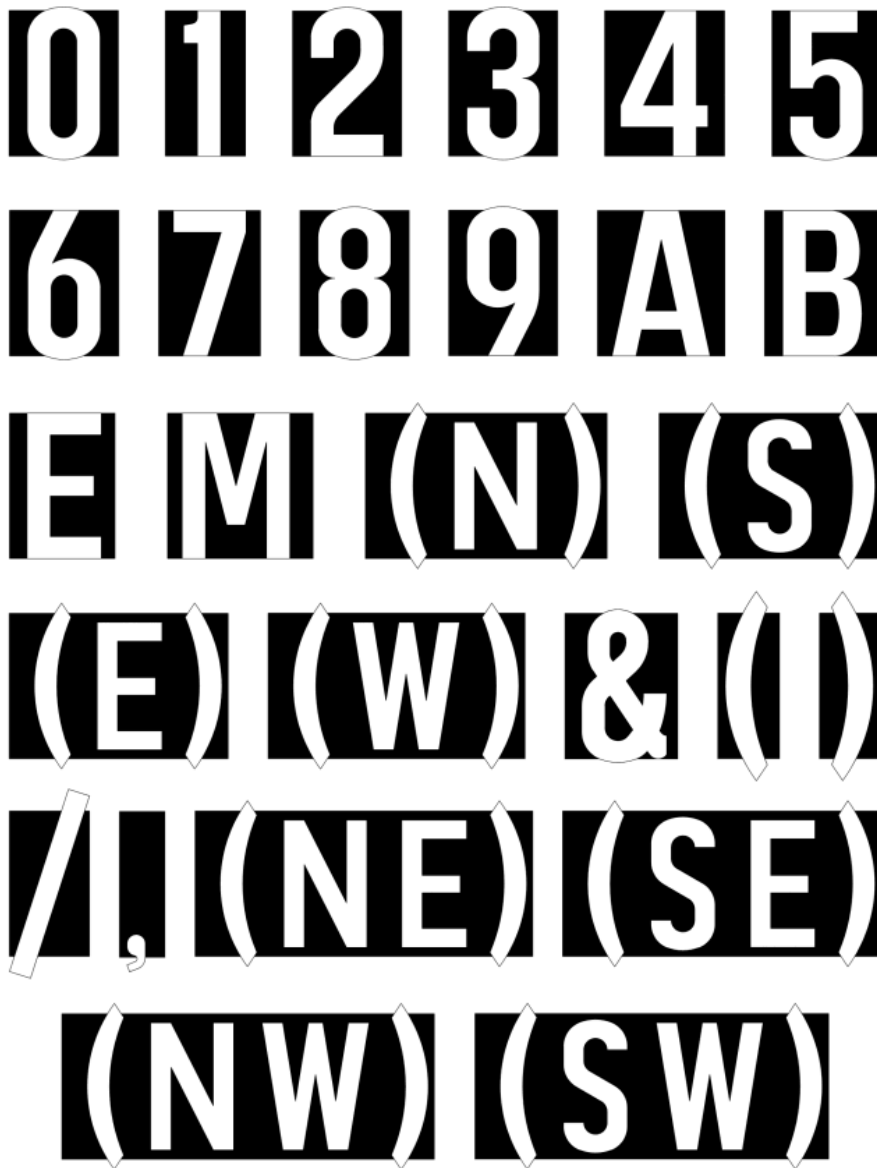

*Status:* This is the original version (as it was originally made). This item of legislation is currently only available in its original format.

PART IV  
PROPORTIONS AND FORM OF LETTERS,  
NUMERALS AND OTHER CHARACTERS

SCHEDULE 13 PART IV Regulation 13(6)  
PROPORTIONS AND FORM OF LETTERS, NUMERALS AND OTHER CHARACTERS  
(for route numbers on temporary motorway signs with yellow backgrounds)



**Status:** This is the original version (as it was originally made). This item of legislation is currently only available in its original format.

## PART V

### PROPORTIONS AND FORM OF LETTERS, NUMERALS AND OTHER CHARACTERS FOR USE ON VARIABLE MESSAGE SIGNS

#### SCHEDULE 13 PART V

Regulation 13(9)

PROPORTIONS AND FORM OF LETTERS, NUMERALS AND OTHER CHARACTERS FOR USE ON VARIABLE MESSAGE SIGNS  
(where the characters shown in Parts I, II, III and IV cannot be used because of the method of construction or operation of the sign)

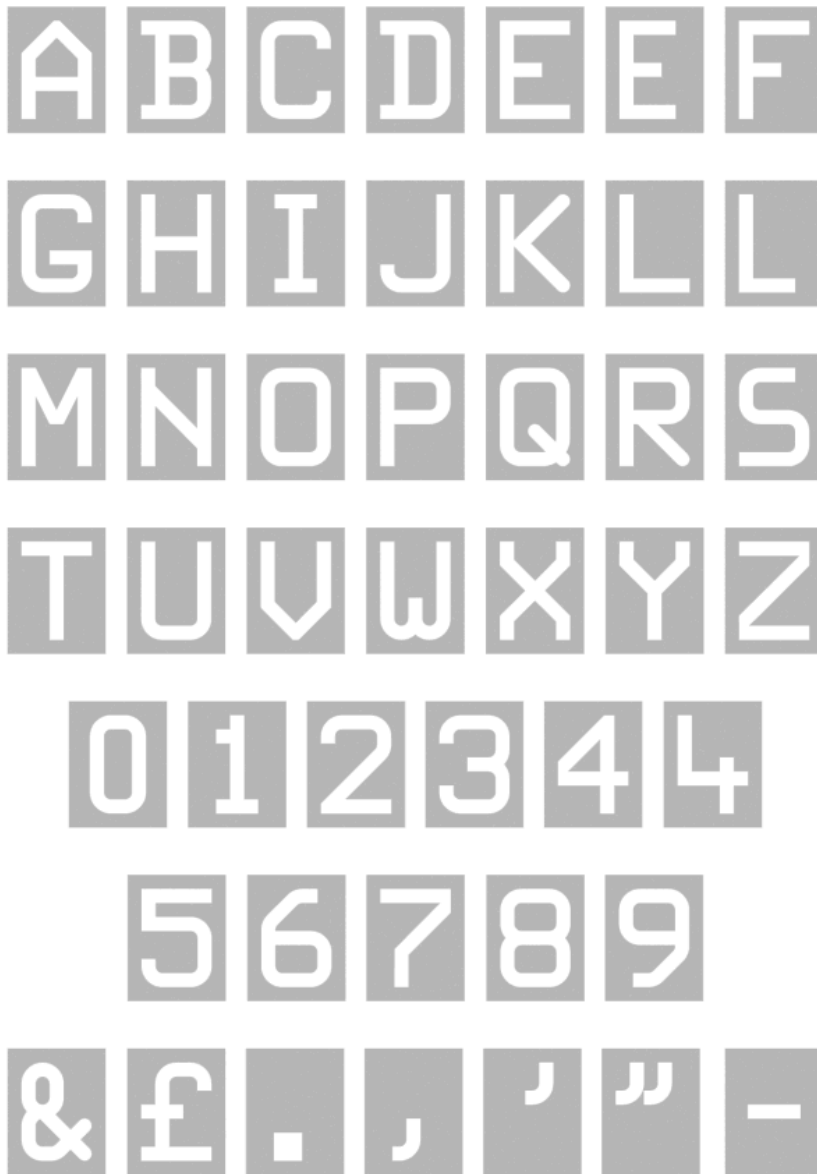

**Status:** This is the original version (as it was originally made). This item of legislation is currently only available in its original format.

## PART VI

### PROPORTIONS AND FORM OF LETTERS, NUMERALS AND OTHER CHARACTERS FOR USE IN THE ROAD MARKINGS SHOWN IN SCHEDULE 6

#### SCHEDULE 13 PART VI

Regulation 13(10)

PROPORTIONS AND FORM OF LETTERS, NUMERALS AND OTHER CHARACTERS FOR USE IN THE ROAD MARKINGS SHOWN IN SCHEDULE 6  
(a) with a height of 1.6 metres (the characters shall be varied proportionally to a height of 1.035 metres or 0.705 metres when used to form the words of those heights shown in diagrams 1058 and 1058.1)

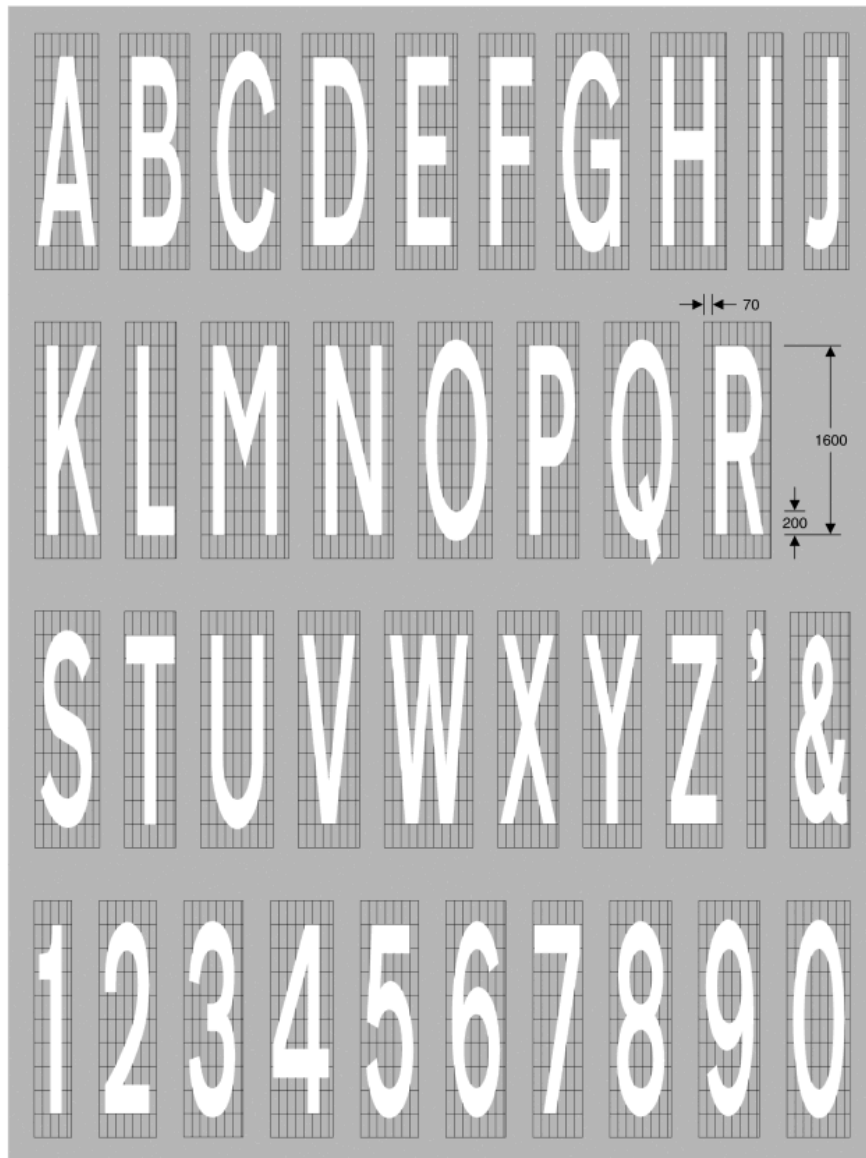

**Status:** This is the original version (as it was originally made). This item of legislation is currently only available in its original format.

SCHEDULE 13 PART VI Regulation 13(10)  
PROPORTIONS AND FORM OF LETTERS, NUMERALS AND OTHER CHARACTERS FOR USE IN THE ROAD MARKINGS SHOWN IN SCHEDULE 6  
(b) with a height of 2.8 metres

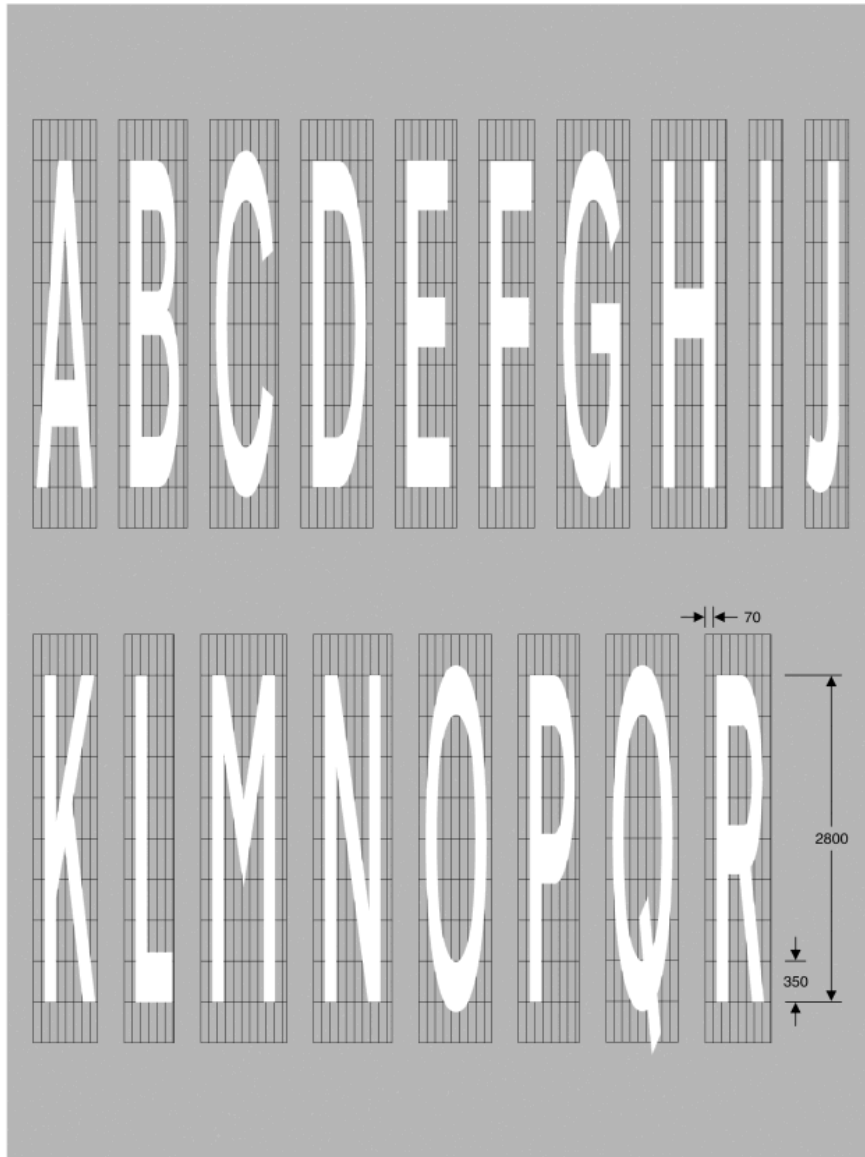

**Status:** This is the original version (as it was originally made). This item of legislation is currently only available in its original format.

SCHEDULE 13 PART VI PROPORTIONS AND FORM OF LETTERS, NUMERALS AND OTHER CHARACTERS FOR USE IN THE ROAD MARKINGS SHOWN IN SCHEDULE 6 (contd.)  
(b) with a height of 2.8 metres

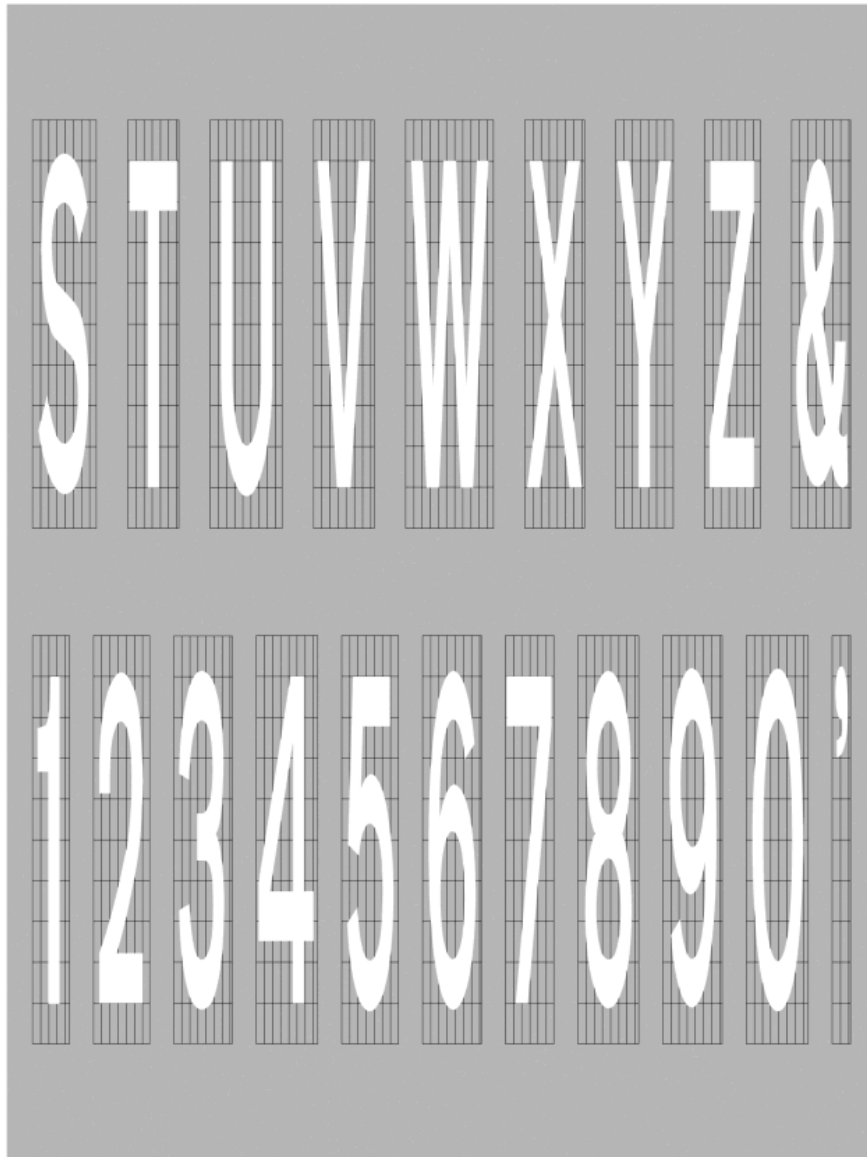

**Status:** This is the original version (as it was originally made). This item of legislation is currently only available in its original format.

SCHEDULE 13 PART VI

Regulation 13(10)

PROPORTIONS AND FORM OF LETTERS, NUMERALS AND OTHER CHARACTERS FOR USE IN THE ROAD MARKINGS SHOWN IN SCHEDULE 6  
(c) for use in the road markings shown in diagrams 1027.1, 1028.2, 1028.3, 1028.4, 1029, 1032 and 1033

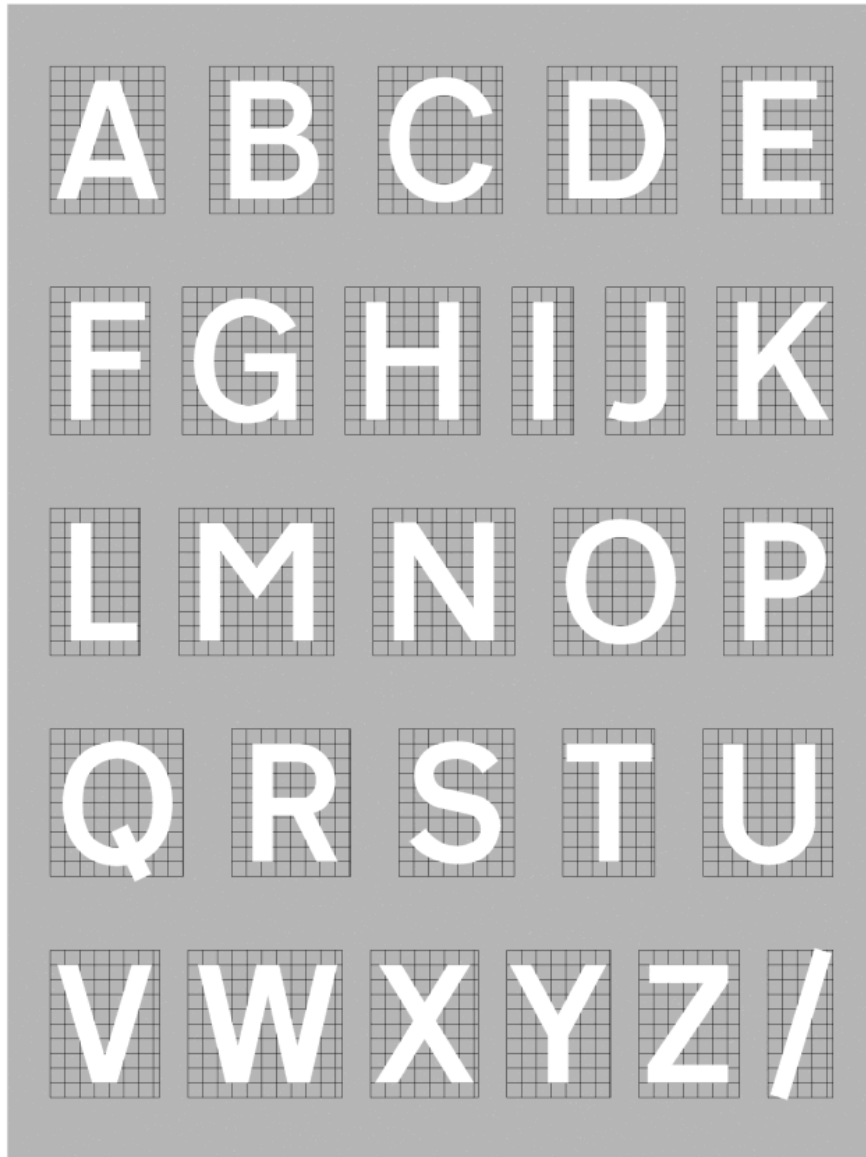



**Status:** This is the original version (as it was originally made). This item of legislation is currently only available in its original format.

## PART VII

### PROPORTIONS AND FORM OF LETTERS, NUMERALS AND OTHER CHARACTERS

SCHEDULE 13 PART VII Regulation 13(11)  
PROPORTIONS AND FORM OF LETTERS, NUMERALS AND OTHER CHARACTERS  
(Symbols for use on directional signs to indicate diversion routes)

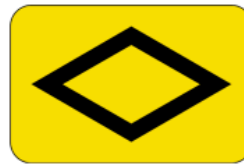
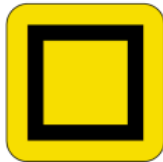
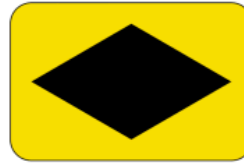

**Status:** This is the original version (as it was originally made). This item of legislation is currently only available in its original format.

## SCHEDULE 14

### PROPORTIONS AND FORM OF SYMBOLS INDICATING TYPES OF TOURIST DESTINATION

#### PART I

### PROPORTIONS AND FORM OF SYMBOLS INDICATING TYPES OF TOURIST DESTINATION IN ENGLAND, SCOTLAND AND WALES

#### SCHEDULE 14 PART I

Regulation 13(12)

#### PROPORTIONS AND FORM OF SYMBOLS INDICATING TYPES OF TOURIST DESTINATION IN ENGLAND, SCOTLAND AND WALES



T1  
Tourist Information Point  
or Centre



T2  
Castle of historic  
or architectural interest



T3  
House of historic  
or architectural interest



T4  
Picnic area



T5  
Youth Hostel  
(See caption under diagram 2303  
for usage)



T6  
Caravan site or park  
(See caption under diagram 2301  
for usage)



T7  
Camping site or park  
(See caption under diagram 2301  
for usage)



T8  
Woodland recreation area



T9  
Viewpoint



T10  
Light refreshment facilities



T11  
Restaurant



T12  
Hotel or other overnight accommodation

**Status:** This is the original version (as it was originally made). This item of legislation is currently only available in its original format.

## PART II

### PROPORTIONS AND FORM OF SYMBOLS INDICATING TYPES OF TOURIST DESTINATION IN ENGLAND AND WALES

#### SCHEDULE 14 PART II

Regulation 13(12)

#### PROPORTIONS AND FORM OF SYMBOLS INDICATING TYPES OF TOURIST DESTINATION IN ENGLAND AND WALES



T101  
National Trust property



T102  
Flower garden or horticultural exhibition

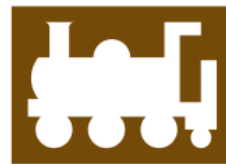

T103  
Preserved or tourist railway or railway museum



T104  
Water sport activities



T105  
Church of historic or architectural interest



T106  
Cathedral of historic or architectural interest



T107  
Wildlife park



T108  
Windmill of historic or architectural interest



T109  
Zoo



T110  
Agricultural museum



T111  
Equestrian centre



T112  
Country park

**Status:** This is the original version (as it was originally made). This item of legislation is currently only available in its original format.

SCHEDULE 14 PART II PROPORTIONS AND FORM OF SYMBOLS INDICATING TYPES OF TOURIST DESTINATION IN ENGLAND AND WALES (contd.)



T113  
Bird garden



T114  
Pleasure or theme park  
(Both trees may be of the same type,  
and either or both trees may be omitted)



T115  
Nature reserve



T116  
Historic dockyard or attraction  
of maritime interest



T117  
Air museum



T118  
Beach



T119  
Farm park



T120  
Pottery or craft centre



T121  
Prehistoric site or  
monument



T122  
Butterfly farm



T123  
Canal-side attraction



T124  
Industrial heritage museum  
or attraction

**Status:** This is the original version (as it was originally made). This item of legislation is currently only available in its original format.

SCHEDULE 14 PART II PROPORTIONS AND FORM OF SYMBOLS INDICATING TYPES OF TOURIST DESTINATION IN ENGLAND AND WALES (contd.)



T125  
Watermill of historic or architectural interest



T126  
Aquarium or oceanarium



T127  
Site with Roman remains



T128  
Heavy horse centre



T129  
Motor museum



T130  
Craft centre or forge



T131  
Spa, spring or fountain of particular interest



T132  
Farm trail



T133  
Vineyard



T134  
Golf course



T135  
Race course



T136  
Motor sport

**Status:** This is the original version (as it was originally made). This item of legislation is currently only available in its original format.

SCHEDULE 14 PART II PROPORTIONS AND FORM OF SYMBOLS INDICATING TYPES OF TOURIST DESTINATION IN ENGLAND AND WALES (contd.)



T137  
Cricket ground



T138  
Football ground



T139  
Canoeing



T140  
Fishing



T141  
Boat hire



T142  
Cycle hire



T143  
Woodland walk  
in a coniferous forest



T144  
Woodland walk  
in a deciduous or mixed forest



T145  
Outdoor pursuits centre



T146  
Roller skating



T147  
Ice skating



T148  
Ski slope

**Status:** This is the original version (as it was originally made). This item of legislation is currently only available in its original format.

SCHEDULE 14 PART II PROPORTIONS AND FORM OF SYMBOLS INDICATING TYPES OF TOURIST DESTINATION IN ENGLAND AND WALES (contd.)



T149  
Ten pin bowling



T150  
Birds of prey centre



T151  
RSPB bird reserve



T152  
Centre approved by the  
Rare Breeds Survival Trust



T153  
Safari park



T154  
Battlefield site



T155  
Brass rubbing centre



T156  
Tower or folly of historic  
or architectural interest



T157  
Historic building



T158  
Lighthouse open  
to the public



T159  
Pier



T160  
Swimming pool or  
indoor water sports centre

**Status:** This is the original version (as it was originally made). This item of legislation is currently only available in its original format.

### PART III

## PROPORTIONS AND FORM OF SYMBOLS INDICATING TYPES OF TOURIST DESTINATION IN ENGLAND ONLY

#### SCHEDULE 14 PART II PROPORTIONS AND FORM OF SYMBOLS INDICATING TYPES OF TOURIST DESTINATION IN ENGLAND AND WALES (contd.)

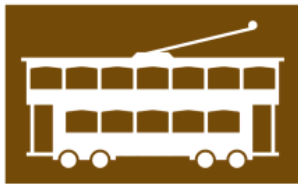

T161  
Tram museum



T162  
Bus museum



T163  
Cinema



T164  
Theatre or concert hall

#### SCHEDULE 14 PART III

Regulation 13(12)

#### PROPORTIONS AND FORM OF SYMBOLS INDICATING TYPES OF TOURIST DESTINATION IN ENGLAND ONLY



T201  
Tourist attraction recognised by a regional tourist board or the English Tourist Board



T202  
Property in the care of English Heritage



T203  
Museum or art gallery



T204  
Sports centre



T205  
National Nature Reserve designated by English Nature



**Status:** This is the original version (as it was originally made). This item of legislation is currently only available in its original format.

## PART IV

### PROPORTIONS AND FORM OF SYMBOLS INDICATING TYPES OF TOURIST DESTINATION IN SCOTLAND ONLY

#### SCHEDULE 14 PART IV

Regulation 13(12)

#### PROPORTIONS AND FORM OF SYMBOLS INDICATING TYPES OF TOURIST DESTINATION IN SCOTLAND ONLY



T301.1  
Tourist attraction recognised by VisitScotland  
(The thistle symbol may be shown in white on a brown sign indicating a National Tourist Route)



T302  
Property in the care of Historic Scotland  
(The legend "Historic Scotland" may be added)



T303  
National Trust for Scotland property  
(The legend "National Trust for Scotland" in any style of lettering may be added and the symbol varied to white on a brown background)



T304  
Forestry Commission property

#### SCHEDULE 14 PART V

Regulation 13(12)

#### PROPORTIONS AND FORM OF SYMBOLS INDICATING TYPES OF TOURIST DESTINATION IN WALES ONLY



T401  
Tourist attraction recognised by the Wales Tourist Board



T402  
Museum or art gallery



T403  
Property in the care of Cadw

**Status:** This is the original version (as it was originally made). This item of legislation is currently only available in its original format.

## SCHEDULE 15

Regulation 58

## LEGENDS FOR USE ON VARIABLE MESSAGE SIGNS

## PART I

## PRELIMINARY

1.—(1) In a legend prescribed by this Schedule the number of a junction shall be shown in the form of the letter “J” followed by the number of the junction.

(2) Where this Schedule provides for a route number to be displayed on a sign, a compass point (“NORTH”, “SOUTH”, “EAST” or “WEST”) or an abbreviated compass point (“N”, “S”, “E”, “W”, “NW”, “NE”, “SW” or “SE”) may be added to the route number.

(3) Where any part of a legend prescribed by this Schedule is shown in square brackets, the brackets shall not be displayed on a sign.

(4) Different legends or different parts of the same legend displayed on a sign in accordance with this Schedule may be separated by a dash.

## PART II

## SIGNS AUTOMATICALLY ACTIVATED BY VEHICULAR TRAFFIC

2. One of the following legends may be displayed on a sign which is activated by a particular type of vehicle approaching the equipment which controls the sign—

- (a) “OVERHEIGHT VEHICLE DIVERT” with—
  - (i) an arrow;
  - (ii) “USE” and a route number; or
  - (iii) “FOLLOW” and a symbol shown in Part VII of Schedule 13;
- (b) “OVERHEIGHT VEHICLE TURN BACK”;
- (c) “HIGH VEHICLE USE MIDDLE OF ROAD”;
- (d) “ONCOMING VEHICLE IN MIDDLE OF ROAD”.

## PART III

LEGENDS GIVING WARNINGS OF ADVERSE WEATHER  
OR OTHER TEMPORARY HAZARDS OR INCIDENTS

3.—(1) A legend specified in sub-paragraph (2) may only be used in conjunction with—

- (a) a legend specified in Part IV;
- (b) a legend specified in Part V; or
- (c) a combination of a legend specified in Part IV and a legend specified in Part V.

(2) The legends specified in this sub-paragraph are—

- (a) “ACCIDENT”;
- (b) “ANIMALS”;

- (c) a route number, a junction number or “EXIT” and “CLOSED”;
- (d) “CONGESTION”;
- (e) “DEBRIS”;
- (f) “DELAYS”;
- (g) “DIVERSION”;
- (h) “EXIT CLOSED”;
- (i) “FLOODS”;
- (j) “FOG”;
- (k) “FOG PATCHES”;
- (l) “INCIDENT”;
- (m) “LANE CLOSURE”;
- (n) “LANE[S]” followed by a number or numbers and “CLOSED”;
- (o) “LARGE LOAD”;
- (p) “LONG DELAYS”;
- (q) “MOBILE WORKS”;
- (r) “MOTORWAY CLOSED”;
- (s) “NO PHONES”;
- (t) “OBSTRUCTION”;
- (u) “PEDESTRIANS”;
- (v) “QUEUE”;
- (w) “ROAD CLOSED”;
- (x) “ROAD WORKS”;
- (y) “SKID RISK”;
- (z) “SLIP ROAD CLOSED”;
- (aa) “SMOKE”;
- (bb) “SNOW”;
- (cc) “SNOW PLOUGH”;
- (dd) “SPRAY”;
- (ee) “STRANDED VEHICLE”;
- (ff) “[STRONG] WINDS”;
- (gg) “[The name of a tunnel] TUNNEL CLOSED”;
- (hh) “WEIGHT CHECK”;
- (ii) “WORKFORCE”.

(3) The following legends may be displayed on their own or in conjunction with another legend as mentioned in sub-paragraph (1)—

- (a) “[The name of a bridge] BRIDGE CLOSED”;
- (b) “BUS LANE CLOSED”;
- (c) “GRITTING IN PROGRESS”;
- (d) “NEXT SERVICE AREA CLOSED”;
- (e) “ONCOMING VEHICLE”;

*Status: This is the original version (as it was originally made). This item of legislation is currently only available in its original format.*

- (f) “SETTING OUT ROAD WORKS”;
  - (g) “SLOW MOVING LARGE LOAD”.
- (4) In sub-paragraphs (2) and (3) square brackets are used to indicate things which may be omitted.

## PART IV

### LEGENDS INDICATING LOCATION OF TEMPORARY HAZARD OR INCIDENT

4. One of the following legends may be used only in conjunction (either on its own or in combination with a legend specified in Part V) with a legend specified in Part III—

- (a) a route number;
- (b) “ON [name of bridge] BRIDGE” or “ON BRIDGE”;
- (c) “AT” together with—
  - (i) a place name,
  - (ii) the name of a bridge or tunnel,
  - (iii) a junction name or number or a junction number and “EXIT”, or
  - (iv) “NEXT JCT” or “TOLL”;
- (d) “AFTER” together with—
  - (i) a place name,
  - (ii) the name of a bridge or tunnel,
  - (iii) “BRIDGE” or “TUNNEL”,
  - (iv) a junction name or number, or
  - (v) “NEXT JCT”;
- (e) a number and “MILES”;
- (f) “AHEAD” preceded by a legend specified in paragraph 3(2)(v) or (w) only;
- (g) “FOR” together with a number and “MILES”;
- (h) “IN ROAD”;
- (i) a junction number;
- (j) a junction number “TO” and another junction number;
- (k) “ON SLIP ROAD”;
- (l) “TO” and a route number.

## PART V

### ADDITIONAL INFORMATION

5.—(1) A legend specified in sub-paragraph (2) may be used only in conjunction with a legend specified in Part III or a combination of a legend specified in Part III and a legend specified in Part IV.

- (2) The legends referred to in sub-paragraph (1) are—
- (a) a number and “HR DELAYS”;

*Status: This is the original version (as it was originally made). This item of legislation is currently only available in its original format.*

- (b) [“ALL TRAFFIC”] [“CARS”] [“CARAVANS”] [“HGV'S”] [“HIGH SIDED VEHS”] [“AND”] [“M'CYCLES”] “USE” and a route number or “BUS LANE” or “HARD SHOULDER”;
- (c) [“ALL TRAFFIC”] [“CARS”] [“CARAVANS”] [“HGV'S”] [“HIGH SIDED VEHS”] [“AND”] [“M'CYCLES”] “FOLLOW” and a symbol shown in Part VII of Schedule 13 or a place name;
- (d) [“ALL TRAFFIC”] [“CARS”] [“CARAVANS”] [“HGV'S”] [“HIGH SIDED VEHS”] [“AND”] [“M'CYCLES”] and “LEAVE AT NEXT JCT”, “LEAVE AT” and a junction name or number;
- (e) “[ALTERNATIVE ROUTE] FOLLOW” and a symbol shown in Part VII of Schedule 13 or a place name;
- (f) “[ALTERNATIVE ROUTE] USE” and a route number;
- (g) “AT” and a place name, the name of a bridge or tunnel, “BRIDGE” or “TUNNEL”, or a junction name or number, or “NEXT JCT”;
- (h) “AVOID LANE CHANGES”;
- (i) “DO NOT USE HARD SHOULDER”;
- (j) “FOR” and a place name “USE” and a route number;
- (k) “FOR” and a place name “FOLLOW” and a symbol shown in Part VII of Schedule 13 or another place name;
- (l) “HGV'S LEAVE MOTORWAY”;
- (m) “LEAVE AT NEXT JCT”;
- (n) “LEAVE AT” and a junction name or number;
- (o) “REJOIN MAIN CARRIAGEWAY”;
- (p) “SLOW”;
- (q) “SLOW DOWN”.

(3) In the legends specified in paragraphs (b), (c) and (d) of sub-paragraph (2), one or more of the words in square brackets may be included as appropriate.

(4) In the legends specified in paragraphs (e) and (f) of sub-paragraph (2) anything in square brackets may be omitted.

(5) In the legends specified in paragraphs (b) and (i) of sub-paragraph (2) “HARDSHOULDER” may be substituted for “HARD SHOULDER”.

## PART VI

### OTHER LEGENDS

6.—(1) The following legends may also be displayed on a variable message sign—

- (a) “SIGNAL[S] UNDER TEST”;
- (b) “SIGNAL TESTS FOR” and a number of “MILES”;
- (c) “SIGNAL TESTS ON SLIP ROAD”;
- (d) “SIGN[S] UNDER TEST”;
- (e) “END OF SIGNAL TESTS”;
- (f) “END OF SIGN TESTS”.

*Status: This is the original version (as it was originally made). This item of legislation is currently only available in its original format.*

(2) The legends specified in paragraphs (a) to (d) of sub-paragraph (1) may be displayed with a pattern which has no particular meaning but which is designed to test the functioning of the variable message sign on which it is displayed.

(3) In the legends specified in paragraphs (a) and (d) of sub-paragraph (1) the letter shown in square brackets may be omitted.

## SCHEDULE 16

Regulation 17(1)

## PERMITTED VARIANTS

<i>(1)</i> <i>Item</i>	<i>(2)</i> <i>Diagram numbers</i>	<i>(3)</i> <i>Permitted variants</i>
1.	513.2, 523.1, 524.1, 530, 531.1, 532.2, 532.3, 629, 629A, 629.1, 629.2, 629.2A, 670, 672, 673, 675 (in respect of the upper panel of the sign), 780A, 780.1A (in respect of height), 780.2A, 818.3 (other than in respect of distance), 6001, 7275, 7283, 7283.1, 7284, 7284.1, 7290 (in respect of speed limit), 7292, 7294	Numerals may be varied but (with the exception of one decimal place of a metre indicating a height, width or length) no fractions or decimal places shall be used.
2.	629.1	Metric units to one decimal place of a metre may be substituted for imperial units when the sign is placed in combination with another sign shown in diagram 629.1 which has not been so varied.
3.	518, 519, 530.1, 543.1, 546, 547.1, 547.2, 547.4, 547.7, 547.8, 563, 563.1, 773, 883, 950.1, 2001, 2002, 2003, 2004, 2005, 2005.1, 2006, 2007, 2008, 2009, 2022, 2023, 2024, 2025, 2026, 2027, 2027.1, 2028, 2029, 2033, 2035, 2101, 2102, 2102.1, 2104, 2105.1, 2108, 2109, 2110, 2111, 2112, 2113, 2113.1, 2118, 2119, 2120, 2121, 2122, 2126.1, 2127, 2131, 2132, 2133, 2134, 2135, 2136, 2139, 2140, 2141, 2205, 2213, 2214, 2215, 2216, 2218, 2308.1, 2322, 2323, 2324, 2325, 2326, 2327, 2328, 2329, 2504, 2505, 2505.1, 2506, 2507, 2509.1, 2510,	An indication of distance may be shown in accordance with item 5 or 6.

**Status:** This is the original version (as it was originally made). This item of legislation is currently only available in its original format.

(1) Item	(2) Diagram numbers	(3) Permitted variants
	2511, 2512, 2513, 2601.1, 2601.2, 2603, 2605, 2606, 2607, 2608, 2609, 2610, 2610.2, 2701, 2701.1, 2705, 2706, 2707, 2801, 2802, 2803, 2804, 2805, 2806, 2925, 2929+, 7001.1  +When used on a motorway exit slip road.	
4.	2911, 2912, 2917, 2918	Numerals indicating distance may be varied with distances being expressed in miles to the nearest mile.
5.	527, 583.1, 584.1, 2001, 2002, 2003, 2004, 2005, 2005.1, 2006, 2007, 2008, 2009, 2022, 2023, 2024, 2025, 2026, 2027, 2027.1, 2028, 2029, 2030, 2030.1, 2033, 2035, 2101, 2102, 2102.1, 2103, 2104, 2105.1, 2106.1, 2107, 2108, 2109, 2110, 2111, 2111.1, 2112, 2113, 2113.1, 2118, 2119, 2120, 2121, 2122, 2125, 2126, 2126.1, 2127, 2128, 2131, 2132, 2141, 2209, 2213, 2214, 2215, 2218, 2308.1, 2309.1, 2328, 2329, 2601.1, 2601.2, 2602.1, 2705, 2706, 2707, 2803, 2804, 2805, 2806, 2925, 2926, 2929+  +When used on a motorway exit slip road.	Numerals indicating distance may be varied with distances being expressed in miles except that the fractions $\frac{3}{4}$ , $\frac{1}{2}$ and $\frac{1}{4}$ may be used for distances of less than 3 miles.
6.	502, 503, 518, 519, 530.1, 543.1, 546, 547.1, 547.2, 547.3, 547.4, 547.7, 547.8, 548.1, 553.2, 554.3, 556.2, 557.2, 557.3, 557.4, 558.2, 563, 563.1, 570, 572, 573, 615.1, 773, 780.1A (in respect of distance), 811.1, 817.2, 818.1 (in respect of distances not exceeding 2 miles), 818.2 and 818.3 (in respect of distance), 820.1, 821, 876, 883, 950.1, 2010.1, 2123, 2133, 2134, 2135, 2136,	(1) Numerals indicating distance may be varied with— (a) distances of over 3 miles being expressed in miles to the nearest mile; (b) distances of $\frac{1}{2}$ mile or more but less than 3 miles being expressed to the nearest $\frac{1}{4}$ mile with the fractions $\frac{3}{4}$ , $\frac{1}{2}$

**Status:** This is the original version (as it was originally made). This item of legislation is currently only available in its original format.

(1) Item	(2) Diagram numbers	(3) Permitted variants
	<p>2139, 2140, 2201, 2202, 2203, 2204, 2205, 2216, 2301, 2302, 2303, 2304, 2305, 2306, 2307, 2322, 2323, 2324, 2325, 2326, 2327, 2501, 2502, 2503, 2504, 2505, 2505.1, 2506, 2507, 2508, 2509.1, 2510, 2511, 2512, 2513, 2603, 2604, 2605, 2606, 2607, 2608, 2609, 2610, 2610.1, 2610.2*, 2701, 2701.1, 2713.1, 2801, 2802, 5014, 7001.1, 7004, 7012**, 7015**, 7030, 7201.1, 7208, 7209, 7256, 7306, 7307</p> <p>*Distances may be expressed as “yards”, “yds”, “mile”, “miles”, “m”, “YARDS”, “YDS”, “MILE”, “MILES”, or “M”.</p> <p>**Distances shall be expressed as “YARDS”, “MILE” or “MILES”</p>	<p>and <math>\frac{1}{4}</math> being used; and</p> <p>(c) distances of less than <math>\frac{1}{2}</math> mile being expressed in yards to the nearest 10 yards other than on the signs shown in diagrams 7012 and 7015, “yards” or the abbreviation “yds” may be used interchangeably.</p> <p>(2) Where a sign includes a distance expressed in miles, “mile” as shown in diagram 2303, “miles” as shown in diagram 2316 or the distance on its own as shown in diagram 2202 shall be used as appropriate.</p> <p>(3) Where a sign includes distances expressed in both miles and yards, the abbreviation “m” shall be used to indicate those distances expressed in miles.</p>
7.	<p>832.6, 832.7, 2011, 2012, 2013, 2014, 2015, 2017, 2020, 2021, 2101.1, 2101.2, 2115, 2116, 2117, 2903, 2904, 2905, 2906, 2908, 2908.1, 2909, 2914, 2914.1</p>	<p>(1) Numerals indicating distance to a junction ahead may be added or varied. The numerals may be one of the following: “1”, “<math>\frac{2}{3}</math>”, “<math>\frac{1}{2}</math>” or “<math>\frac{1}{3}</math>”.</p> <p>(2) Where a distance to a second exit is shown on the sign, the numerals indicating that distance may be as indicated above, or additionally “2”, “<math>1\frac{3}{4}</math>”, “<math>1\frac{2}{3}</math>”, “<math>1\frac{1}{2}</math>”, “<math>1\frac{1}{3}</math>”, “<math>1\frac{1}{4}</math>” or “<math>\frac{3}{4}</math>”.</p>
8.	<p>2310.1, 2313.1, 2313.3, 2313.5, 2919.1*</p> <p>*“1m” permitted variant does not apply to this sign.</p>	<p>“<math>\frac{1}{2}</math>m” may be varied to “2m”, “<math>1\frac{1}{2}</math>m”, “1m”, “<math>\frac{2}{3}</math>m” or “<math>\frac{1}{3}</math>m”.</p>
9.	<p>557.4, 573, 780.1A, 2020, 2021, 2103, 2106.1, 2107, 2111.1, 2112, 2116, 2117,</p>	<p>The indication of distance may be omitted from the sign.</p>



**Status:** This is the original version (as it was originally made). This item of legislation is currently only available in its original format.

<i>(1)</i> <i>Item</i>	<i>(2)</i> <i>Diagram numbers</i>	<i>(3)</i> <i>Permitted variants</i>
	2125, 2126, 2202, 2203, 2204, 2302, 2304, 2306, 2309.1, 2508, 2602.1, 2604, 2610.1, 2713.1, 2908, 2908.1, 2909, 7030	
10.	818.2, 818.3, 2201, 2301, 2303, 2305, 2307, 2501, 2502	The indication of distance may be replaced by an arrow pointing horizontally to the left or to the right as appropriate.
11.	518, 519, 530.1, 531.2, 543.1, 546, 547.1, 547.2, 547.4, 547.7, 547.8, 548.1, 563, 563.1, 584.1, 636, 637.1, 637.3, 638, 639.1B, 650.1, 650.2, 650.3, 651, 660, 660.3, 660.4, 660.5, 660.6, 661A, 661.1, 662, 667, 667.1, 667.2, 668, 668.1, 668.2, 773, 818.2, 818.3, 818.4, 820, 883, 950.1, 2201, 2205, 2301, 2303, 2305, 2307, 2501, 2502, 2713.1, 7001.1, 7030	An arrow may be added to the sign, pointing to the left or to the right as appropriate.
12.	2003, 2005, 2005.1, 2006, 2016, 2019, 2020*, 2028, 2029, 2102.1, 2103, 2106.1, 2107, 2111, 2114, 2116*, 2124.1, 2126.1, 2127, 2131, 2133, 2135, 2137.1, 2139, 2202, 2210, 2213, 2215, 2216, 2308.1, 2311.2, 2313.2, 2313.4, 2313.6, 2314.2, 2324, 2326, 2328, 2505, 2505.1, 2506, 2509.1, 2511, 2601.1, 2603, 2610.1, 2610.2, 2701.1, 2702, 2703, 2705, 2708, 2709, 2716, 2801, 2803, 2805, 2902.1, 2908*, 2913.2, 2920.1, 2921.1, 2924, 2926, 2927, 2929, 7018, 7303, 7304	The direction in which the arrow or arrows point may be varied.

\*The arrow in the upper sign panel shall point upwards to the left at an appropriate angle. The arrow in the lower sign panel shall point vertically upwards or point upwards to the right at an appropriate angle.

**Status:** This is the original version (as it was originally made). This item of legislation is currently only available in its original format.

<i>(1)</i> <i>Item</i>	<i>(2)</i> <i>Diagram numbers</i>	<i>(3)</i> <i>Permitted variants</i>
13.	515, 515.1, 553, 557.3, 557.4, 573, 606*, 638.1, 639, 640, 640.2A, 660.7, 661.2A, 780.1A, 788, 810, 962, 962.1, 962.2, 2711*, 2713, 2717, 5013, 5014, 7104  *The arrow may also point vertically upwards.	The direction of the arrow or chevron may be varied with the arrow or chevron pointing horizontally to the left or to the right.
14.	557.4, 638.1, 639, 640, 640.2A, 660.7, 780.1A, 962, 962.1, 962.2, 2716, 5014	The arrow may be omitted from the sign.
15.	832.9, 2026, 2027, 2027.1, 2125, 2126, 2132, 2134, 2136, 2137, 2140, 2141, 2203, 2204, 2208, 2211, 2212, 2214, 2302, 2304, 2306, 2309.1, 2311.1, 2314.1, 2322, 2323, 2325, 2327, 2329, 2504, 2507, 2508, 2512, 2602.1, 2604, 2605, 2606, 2607, 2608, 2609, 2610, 2701, 2704, 2707, 2710, 2802, 2804, 2806, 2902, 2921, 7305	The direction in which the sign points may be reversed.
16.	817, 817.2, 868, 868.1, 873, 874, 875, 877, 960, 960.1, 2001, 2002, 2003, 2004, 2005, 2005.1, 2007, 2008, 2009, 2010.1, 2010.2, 2011, 2012, 2013, 2014, 2015, 2017, 2018, 2019, 2021, 2021.1, 2022, 2023, 2024, 2025, 2033, 2101, 2101.1, 2101.2, 2102, 2103, 2104, 2105.1, 2106.1, 2107, 2108, 2109, 2110, 2111, 2112, 2113, 2113.1, 2114, 2114.1, 2115, 2115.1, 2117, 2118, 2119, 2120, 2121, 2122, 2123, 2124, 2216, 2218, 2505, 2505.1, 2509.1, 2513, 2705, 2706, 2803, 2805, 2904, 2904.1, 2908.1, 2909, 2913, 2913.1, 2913.2, 2913.3, 2913.4, 2914, 2914.1, 2924, 2925, 2926, 2929, 6006, 6006.1, 6008, 6009, 6009.1, 6009.2, 7201, 7201.1, 7202, 7203, 7203.1, 7204, 7205, 7206, 7207, 7210, 7211.1, 7212, 7213, 7214,	Route symbols, or the number of arrows and directional sign panels, or symbols indicating which lanes are open or closed to traffic, may be varied.

**Status:** This is the original version (as it was originally made). This item of legislation is currently only available in its original format.

(1) Item	(2) Diagram numbers	(3) Permitted variants
	7215, 7216, 7217, 7218, 7220, 7221, 7230, 7231, 7232, 7233, 7234, 7235, 7236, 7237, 7238, 7239, 7240, 7250, 7251, 7252, 7253, 7254, 7255, 7306, 7402	
17.	504.1, 506.1, 507.1	The thickness of the route symbols, other than the approach route symbol, shall be varied to indicate the priority route through the road junction ahead.
18.	2001, 2002, 2004, 2007, 2008, 2009, 2022, 2023, 2024, 2025, 2033, 2101, 2102, 2104, 2105.1, 2108, 2109, 2110, 2112, 2113, 2113.1, 2118, 2119, 2120, 2121, 2122, 2218, 2513, 2913, 2913.1*, 2914, 2914.1*, 2925	The thickness of the route symbols may be varied to reflect the status of the routes indicated.
	*When indicating a route other than a motorway.	
19.	674, 785.1, 818.4, 881, 2001, 2002, 2003, 2004, 2005, 2005.1, 2006, 2007, 2008, 2009, 2010.1, 2010.2, 2011, 2012, 2013, 2014, 2015, 2016, 2017, 2018, 2019, 2020, 2021, 2021.1, 2022, 2023, 2024, 2025, 2026, 2027, 2027.1, 2028, 2029, 2030, 2030.1, 2033, 2034, 2035, 2101, 2101.1, 2101.2, 2102, 2102.1, 2103, 2104, 2105.1, 2106.1, 2107, 2108, 2109, 2110, 2111, 2111.1, 2112, 2113, 2113.1, 2114, 2114.1, 2115, 2115.1, 2116, 2117, 2118, 2119, 2120, 2121, 2122, 2123, 2124, 2124.1, 2125, 2126, 2126.1, 2127, 2128, 2131, 2132, 2138, 2141, 2201, 2202, 2203, 2209, 2210, 2211, 2213, 2214, 2215, 2216, 2217, 2218, 2301, 2302, 2305, 2306, 2308.1, 2309.1, 2324, 2325, 2326, 2327, 2328, 2329, 2401, 2402.1, 2403.1, 2503, 2504, 2505.1, 2509.1, 2601.1,	<p>(1) Place names, other destinations or junction names may be varied, omitted or added. “City centre”, “Town centre”, “Village centre”, “Village only”, “Other routes”, “Other traffic”, “Through traffic” or “Ring road” may be substituted for the destination. The phrases “via toll road”, “via toll”, “via tunnel”, “via ferry”, “via” and the name of a destination or a route number, “Byway to” and “Single track road” may be used in addition to the destination.</p> <p>(2) “city centre”, “town centre”, “village”, “village only” or “village centre” may be added after the place name. “only” may be added after the place name or other destination.</p> <p>(3) A compass point (“North”, “South”, “East” or “West”), an abbreviated compass point (“N”, “S”, “E”,</p>

**Status:** This is the original version (as it was originally made). This item of legislation is currently only available in its original format.

(1) Item	(2) Diagram numbers	(3) Permitted variants
	2601.2, 2602.1, 2605, 2606, 2607, 2608, 2610, 2610.1, 2701, 2701.1, 2705, 2706, 2707, 2709, 2710, 2716, 2803, 2804, 2805, 2806, 2806.1, 2902, 2903*, 2904, 2904.1, 2905*, 2906, 2908, 2908.1, 2909, 2911, 2913, 2913.1, 2913.2, 2913.3, 2913.4, 2914, 2914.1, 2915, 2924, 2925, 2926, 2927, 2927.1, 2928, 2929, 2929.1, 7241, 7242, 7285, 7286	“W”, “NW”, “NE”, “SW” or “SE”), or “Central” or “C” (meaning “Central”) may be added in brackets after the place name.
	*Destinations may be varied or added, but not omitted.	
20.	818.4**, 877, 2001, 2002, 2003, 2004, 2005, 2005.1, 2006, 2007, 2008, 2009, 2010.1, 2010.2, 2011, 2012, 2013, 2014, 2015, 2016, 2017, 2018, 2019, 2020, 2021, 2021.1, 2022, 2023, 2024, 2025, 2026, 2027, 2027.1, 2028, 2029, 2030, 2030.1, 2031, 2033, 2034, 2035*, 2101, 2101.1, 2101.2, 2102, 2102.1, 2103, 2104, 2105.1, 2106.1, 2107, 2108, 2109, 2110, 2111, 2111.1, 2112, 2113, 2113.1, 2114, 2114.1, 2115, 2115.1, 2116, 2117, 2118, 2119, 2120, 2121, 2122, 2123, 2124, 2124.1, 2125, 2126, 2126.1, 2127, 2128, 2129, 2131, 2132, 2138*, 2217, 2330, 2601.1, 2602.1, 2602.2, 2602.3, 2703, 2704, 2705, 2706, 2707, 2716**, 2805, 2806, 2806.1*, 2901, 2902, 2902.1, 2903, 2904, 2904.1, 2905, 2906, 2908, 2908.1, 2909, 2910, 2910.1, 2911, 2912, 2913, 2913.1, 2913.2, 2913.3, 2913.4, 2914, 2914.1, 2915, 2917, 2927.1, 2929, 2929.1, 7001.2**, 7002A**, 7002B**, 7241, 7242, 7285, 7286	(1) Identification numbers of routes may be added, varied or omitted as appropriate. (2) A compass point (“North”, “South”, “East” or “West”) or an abbreviated compass point (“N”, “S”, “E”, “W”, “NW”, “NE”, “SW” or “SE”) may be added to the route number, shown in brackets in the same colour as the route number, or varied or omitted. (3) Identification numbers of routes to which a particular route leads shall be shown in brackets. A compass point may be added alongside the number within the same pair of brackets in the manner shown in diagram 2020. (4) Superseded route numbers may be retained provided they are cancelled with a diagonal red bar. (5) Any motorway junction numbers may be varied or omitted. The junction number may be shown in either the bottom left hand or top left hand corner of a sign or sign assembly on a motorway.

**Status:** This is the original version (as it was originally made). This item of legislation is currently only available in its original format.

(1) Item	(2) Diagram numbers	(3) Permitted variants
	<p>*Brackets may be omitted from identification numbers of routes and any associated compass points to which a particular route leads other than a motorway. The compass point only may be included in brackets. The compass points “North West”, “North East”, “South West” and “South East” other than indicating a motorway may be shown as appropriate.</p> <p>**Identification numbers of routes to which a particular route leads need not be shown in brackets. Compass points need not be shown in brackets.</p>	<p>(6) The emergency diversion route symbols shown in Part VII of Schedule 13 may be added or omitted from a diagram where shown.</p>
21.	<p>2001, 2002, 2003, 2004, 2005, 2005.1, 2007, 2008, 2009, 2010.1, 2010.2, 2011, 2012, 2013, 2014, 2015, 2016, 2017, 2018, 2019, 2020, 2021, 2021.1, 2022, 2023, 2024, 2025*, 2026*, 2027*, 2027.1*, 2028*, 2029, 2030*, 2030.1*, 2031*, 2033, 2034*, 2035, 2101, 2101.1, 2101.2, 2102, 2103, 2104, 2105.1, 2106.1, 2107, 2108, 2109, 2110, 2111, 2111.1, 2112, 2113, 2113.1, 2114, 2114.1, 2115, 2115.1, 2116, 2117, 2118, 2119, 2120, 2121*, 2122, 2123, 2124, 2124.1, 2125*, 2126*, 2126.1*, 2127, 2128*, 2129*, 2131*, 2132*, 2138*, 2217*, 2805*, 2806*, 2806.1*, 2913*, 2913.1*#, 2913.2*, 2913.3*, 2913.4*, 2914*, 2914.1*#, 2929*+</p> <p>*Permitted variant (1) does not apply to these signs.</p> <p>+When used on a motorway exit slip road.</p>	<p>(1) Where a route leads directly onto a motorway, the motorway route number, destinations and motorway symbol shall be shown in white on a blue panel and the motorway junction number may be shown in white on a black patch on the blue panel in the manner shown in diagrams 2023 and 2104. The blue panel shall have a white border when placed on a green background.</p> <p>(2) Where the route leads indirectly to a motorway, the motorway route number, with or without a compass point (“North”, “South”, “East” or “West”) or an abbreviated compass point (“N”, “S”, “E”, “W”, “NW”, “NE”, “SW” or “SE”), shall be shown in brackets in white on a blue patch. The blue patch shall have a white border when placed on a green, brown or black background.</p>

*Status: This is the original version (as it was originally made). This item of legislation is currently only available in its original format.*

(1) Item	(2) Diagram numbers	(3) Permitted variants
22.	<p>#When indicating a route other than a motorway.</p> <p>2101, 2101.1#, 2101.2#, 2102, 2103, 2104, 2105.1, 2106.1, 2107, 2108, 2109, 2110, 2111, 2111.1, 2112, 2113, 2113.1, 2114#, 2114.1, 2115#, 2115.1#, 2116#, 2117#, 2118, 2119, 2120, 2121, 2122, 2123, 2124, 2124.1#, 2125*, 2126*, 2126.1*, 2127, 2128*, 2129*, 2131, 2132*, 2805*, 2806*, 2913**, 2913.1**##, 2913.2**, 2913.3**, 2913.4**, 2914**, 2914.1**##, 2929*+</p> <p>*Permitted variant (1) does not apply to these signs.</p> <p>**Permitted variant (2) does not apply to these signs.</p> <p>+When used on a motorway exit slip road.</p> <p>#Where the exit at a junction leads directly to both a primary and a non-primary route permitted variant (1) shall apply in respect of the primary route only. The destination and route number of the non-primary route shall be placed on the white background of the sign.</p> <p>##When indicating a route other than a motorway.</p>	<p>(1) Where a route leads directly onto a primary route, the destinations shall appear in white letters and the route number in yellow both on a green panel. The green panel shall have a white border when placed on a blue background.</p> <p>(2) Where a route leads indirectly to a primary route, the route number with or without a compass point (“North”, “South”, “East” or “West”) or an abbreviated compass point (“N”, “S”, “E”, “W”, “NW”, “NE”, “SW” or “SE”) shall be shown in brackets in yellow on a green patch. Where the route number of the primary route has the same route number as the non-primary route to be followed from the junction ahead, the number shall be shown on the green patch without any brackets. The green patch shall have a white border when placed on a black background.</p>
23.	<p>2001, 2002, 2003, 2004, 2005, 2005.1, 2006, 2007, 2008, 2009, 2010.1, 2010.2, 2011*, 2012*, 2013*, 2014*, 2015*, 2016*, 2017*, 2018*, 2019, 2020*, 2021*, 2021.1*, 2022, 2023, 2024, 2025, 2029, 2033, 2035, 2913, 2913.1#, 2913.2, 2913.3, 2913.4, 2914, 2914.1#</p> <p>*Permitted variant does not apply in respect of an exit or</p>	<p>Where a route leads directly onto a non-primary route, the destination, and route number if appropriate, shall appear in black letters on a white panel. Where that route leads indirectly to a primary route, the route number with or without a compass point (“North”, “South”, “East” or “West”) or an abbreviated compass point (“N”, “S”, “E”,</p>

**Status:** This is the original version (as it was originally made). This item of legislation is currently only available in its original format.

(1) Item	(2) Diagram numbers	(3) Permitted variants
	<p>traffic lane at a junction that leads directly to both a primary and a non-primary route.</p> <p>#When indicating a route other than a motorway.</p>	<p>“W”, “NW”, “NE”, “SW” or “SE”) shall be shown in brackets in yellow on a green patch on the white panel.</p> <p>Where the route number of the primary route has the same route number as the non-primary route to be followed from the junction ahead, the number shall be shown on the green patch without any brackets.</p>
24.	<p>2001, 2002, 2003, 2004, 2005, 2005.1, 2006, 2007, 2008, 2009, 2010.1, 2010.2, 2011, 2012, 2013, 2014, 2015, 2016, 2017, 2018, 2019, 2022, 2023, 2024, 2025, 2026, 2027, 2027.1, 2028, 2029, 2033, 2035, 2101, 2101.1, 2101.2, 2102, 2102.1, 2103, 2104, 2105.1, 2106.1, 2107, 2108, 2109, 2110, 2111, 2111.1, 2112, 2113, 2113.1, 2114, 2115, 2115.1, 2118, 2119, 2120, 2121, 2122, 2123, 2124, 2124.1, 2125, 2126, 2126.1, 2127, 2913, 2913.1*, 2913.2, 2913.3, 2914, 2914.1*</p> <p>*When indicating a route other than a motorway.</p>	<p>A symbol shown in Schedule 14 or other approved symbol, or the name of a tourist destination, or such a symbol and such a name together may be shown in white on a brown panel. In the case of the symbols shown in diagrams T6 (caravan site or park), T7 (camping site or park), T10 (light refreshment facilities), T11 (restaurant) and T12 (hotel or other overnight accommodation) a generic description of the facilities may be substituted for the name. The direction in which the symbol faces and the relative positions of the symbol and name shall be reversed as necessary. The brown panel shall have a white border when placed on a green or blue background. A brown panel may be omitted from a diagram on which it is shown.</p>
25.	<p>2001, 2002, 2003, 2004, 2005, 2005.1, 2006, 2007, 2008, 2009, 2010.1, 2010.2, 2011, 2012, 2013, 2014, 2015, 2016, 2017, 2018, 2019, 2022, 2023, 2024, 2028, 2029, 2033, 2035, 2101, 2101.1, 2101.2, 2102, 2102.1, 2103, 2104, 2105.1, 2106.1, 2107, 2108, 2109, 2110, 2111, 2111.1, 2112, 2113, 2113.1, 2114, 2115, 2115.1, 2118, 2119, 2120,</p>	<p>(1) The white lorry symbol shown in diagram 2805 may be incorporated on a black panel to indicate a route recommended for goods vehicles.</p> <p>(2) The lorry symbol may be reversed. The black panel may include (a) one or more destinations in the manner shown in diagram 2007; (b) one or more route numbers in the</p>

**Status:** This is the original version (as it was originally made). This item of legislation is currently only available in its original format.

(1) Item	(2) Diagram numbers	(3) Permitted variants
	2122, 2123, 2124, 2124.1, 2126.1, 2127, 2913, 2913.1*, 2913.2, 2913.3, 2914, 2914.1*  *When indicating a route other than a motorway.	manner shown in diagram 2805 and as indicated in item 4 of the table below that diagram.  (3) The black panel shall have a white border when placed on a green or blue background.  (4) A black panel may be omitted from a diagram on which it is shown.
26.	2001, 2002, 2003, 2004, 2005, 2005.1, 2006, 2007, 2008, 2009, 2010.1, 2010.2, 2011, 2012, 2013, 2014, 2015, 2016, 2017, 2018, 2019, 2022, 2023, 2024, 2028, 2029, 2033, 2035, 2101, 2101.1, 2101.2, 2102, 2102.1, 2103, 2104, 2105.1, 2106.1, 2107, 2108, 2109, 2110, 2111, 2111.1, 2112, 2113, 2113.1, 2114, 2115, 2115.1, 2118, 2119, 2120, 2122, 2123, 2124, 2124.1, 2126.1, 2127, 2913, 2913.1*, 2913.2, 2913.3, 2914, 2914.1*  *When indicating a route other than a motorway.	Directions to a Ministry of Defence establishment may be shown, with destinations appearing in black letters on a white panel with a red border as shown in diagram 2113. There shall be a white rim round the red border when the panel is placed on a green or blue background. A white panel may be omitted from a diagram on which it is shown.
27.	2001, 2002, 2003, 2004, 2005, 2005.1, 2006, 2007, 2008, 2009, 2010.1, 2010.2, 2019, 2022, 2023, 2024, 2033, 2035, 2101, 2102, 2102.1, 2103, 2104, 2105.1, 2106.1, 2107, 2108, 2109, 2110, 2111, 2111.1, 2112, 2113, 2113.1, 2114, 2118, 2119, 2120, 2122, 2123, 2124, 2127	A route recommended for pedal cyclists may be shown, with destinations appearing in white letters together with a white cycle symbol on a blue panel (as shown in diagram 2105.1 or 2106.1 but with or without a route number). The blue panel shall have a white border when placed on a green background. A blue panel may be omitted from a diagram on which it is shown.
28.	505.1, 506.1, 507.1, 512, 512.1, 512.2, 513, 517, 555.1, 559, 609, 660.4, 789, 789.1, 789.2, 818.4, 823, 824, 825, 950, 962, 962.1, 962.2, 963, 963.1, 963.2, 1039, 1057, 2005.1, 2007, 2105.1, 2106.1,	The symbol shall be reversed where appropriate. Where a bus symbol faces left a door shall be shown at the front of that side; when the symbol is reversed to face right a



**Status:** This is the original version (as it was originally made). This item of legislation is currently only available in its original format.

(1) Item	(2) Diagram numbers	(3) Permitted variants
	2108, 2113, 2120, 2135, 2136, 2137, 2137.1, 2307, 2308.1, 2313.2, 2313.4, 2313.6, 2322, 2323, 2324, 2325, 2328, 2329, 2503, 2504, 2505, 2505.1, 2506, 2507, 2508, 2509.1, 2511, 2512, 2513, 2601.1, 2602.1, 2603, 2604, 2605, 2606, 2607, 2608, 2609, 2610, 2610.1, 2711, 2713.1, 2805, 2806, 2929, 4003.1, 4003.4, 6003, 7221	window shall be substituted for the door.
29.	2003, 2004, 2005, 2005.1, 2027, 2027.1, 2105.1, 2106.1, 2107, 2109, 2111, 2112, 2113, 2113.1, 2118, 2119, 2133, 2134, 2137, 2137.1, 2139, 2140, 2202, 2204, 2210, 2211, 2213, 2214, 2215, 2216, 2304, 2306, 2322, 2324, 2325, 2326, 2327, 2602.1, 2605, 2607, 2608, 2609, 2610, 2701, 2701.1, 2801, 2802, 2902, 2924, 2926	The relative positions of the symbol and other legend may be reversed.
30.	2001, 2002, 2003, 2004, 2005, 2005.1, 2006, 2007, 2008, 2009, 2010.1, 2010.2, 2011, 2012, 2013, 2014, 2015, 2016, 2017, 2018, 2019, 2020, 2021, 2021.1, 2022, 2023, 2024, 2025, 2026, 2027, 2027.1, 2028, 2029, 2030, 2030.1, 2033, 2034, 2035, 2101, 2101.1, 2101.2, 2102, 2102.1, 2103, 2104, 2105.1, 2106.1, 2107, 2108, 2109, 2110, 2111, 2111.1, 2112, 2113, 2113.1, 2114, 2114.1, 2115, 2115.1, 2116, 2117, 2118, 2119, 2120, 2121, 2122, 2123, 2124, 2124.1, 2125, 2126, 2126.1, 2127, 2128, 2131, 2132, 2138, 2705, 2706, 2707, 2902, 2903, 2904, 2904.1, 2905, 2906, 2908, 2908.1, 2909, 2911, 2913, 2913.1, 2913.2, 2913.3, 2913.4, 2914, 2914.1, 2915	The aircraft symbol shown in diagram 2011 may be incorporated either with or without the name of an airport. The direction in which the symbol points may be varied, but it shall not point downwards. The symbol shall be coloured white when placed on a green or blue background and be coloured black when placed on a white or yellow background. The symbol may be omitted from a diagram on which it is shown.
31.	2001, 2002, 2003*, 2004, 2005*, 2005.1*, 2006*, 2007,	(1) A sign shown in diagram 523.1, 524.1, 528, 529,

**Status:** This is the original version (as it was originally made). This item of legislation is currently only available in its original format.

(1) Item	(2) Diagram numbers	(3) Permitted variants
	2008, 2009, 2011*, 2012*, 2013*, 2014*, 2015*, 2016*, 2017*, 2018*, 2019*, 2022, 2023, 2024, 2025, 2026*, 2027*, 2027.1*, 2028*, 2029*, 2033, 2035*, 2101, 2101.1*, 2101.2*, 2102, 2102.1*, 2103*, 2104, 2105.1, 2106.1*, 2107*, 2108, 2109, 2110, 2111*, 2111.1*, 2112, 2113, 2113.1, 2114*, 2115*, 2115.1*, 2118, 2119, 2120, 2121, 2122, 2124.1*, 2125*, 2126*, 2126.1*, 2127*, 2133*, 2134*, 2135*, 2136*, 2202*, 2203*, 2218, 2324*, 2325*, 2326*, 2327*, 2505*, 2505.1*, 2506*, 2507*, 2508*, 2509.1*, 2510*, 2511*, 2512*, 2513, 2705*, 2706, 2707*, 2913, 2913.1**, 2913.2*, 2913.3*, 2914, 2914.1**, 2925, 2926*	529.1, 530, 544, 552, 554 (“Ford”, “Gate” or “Gates”), 555.1, 557.1, 612, 613, 616, 617 (with 618.1 varied to “No vehicles” or “No vehicles” and an indication of the distance to the prohibition as shown in diagram 2009), 619, 619.1, 619.2, 622.1A (with symbol reversed where appropriate), 622.5 (with symbol reversed where appropriate), 622.7 (with symbol reversed where appropriate), 622.8, 626.2A (prohibitory roundel only), 629, 629A, 629.1 (with symbol reversed where appropriate), 629.2, 629.2A, 770, 771, 772, 779, 950, 952 (with symbol reversed where appropriate), 953 (with symbols reversed where appropriate) (with 953.2) or 953.1 (with 953.2) may be incorporated as a symbol, and the plate shown in diagram 572 may also be incorporated as a panel beneath the symbol to indicate the distance to the hazard or prohibition indicated by the symbol.
	*Permitted variant (5) does not apply to these signs.	
	**When indicating a route other than a motorway.	
		(2) Where a bus symbol faces left a door shall be shown at the front of that side; when the symbol is reversed to face right a window shall be substituted for the door.
		(3) A white border shall be added around the red triangle or roundel and the black border omitted from the plate shown in diagram 572 when the symbol or plate is placed on a green, brown or blue background on that part of the sign. Such a sign may be omitted from a diagram where it is shown.
		(4) The size of lettering on a sign shown in Schedule 7 Part II shall be as shown in diagram 2027, 2107 or 2108

**Status:** This is the original version (as it was originally made). This item of legislation is currently only available in its original format.

(1) Item	(2) Diagram numbers	(3) Permitted variants
		<p>as appropriate when a sign, symbol or plate is incorporated.</p> <p>(5) The red bar shown in diagram 816 may be incorporated as a symbol. A white border shall be added around the bar when placed on a sign with a green, blue or brown background.</p>
32.	<p>2001, 2002, 2003, 2004, 2005, 2005.1, 2006, 2007, 2008, 2009, 2011, 2012, 2013, 2014, 2015, 2016, 2017, 2018, 2019, 2022, 2023, 2024, 2025, 2026, 2027, 2027.1, 2028, 2029, 2033, 2035, 2101, 2101.1, 2101.2, 2102, 2102.1, 2103, 2104, 2105.1, 2106.1, 2107, 2108, 2109, 2110, 2111, 2111.1, 2112, 2113, 2113.1, 2114, 2115, 2115.1, 2118, 2119, 2120, 2121, 2122, 2124.1, 2125, 2126, 2126.1, 2127, 2131, 2132, 2133, 2134, 2135, 2136, 2202, 2203, 2218, 2324, 2325, 2326, 2327, 2705, 2706, 2707, 2805, 2806, 2913, 2913.1*, 2913.2, 2913.3, 2914, 2914.1*, 2925, 2926, 2929+</p> <p>*When indicating a route other than a motorway.</p> <p>+When used on a motorway exit slip road.</p>	<p>(1) Any of the following legends may be incorporated to indicate a road where a sign to diagram 820 has been placed—</p> <ul style="list-style-type: none"> <li>“unsuitable for heavy goods vehicles”;</li> <li>“unsuitable for HGVs”;</li> <li>“unsuitable for long vehicles”;</li> <li>“unsuitable for wide vehicles”;</li> <li>“unsuitable for buses”;</li> <li>“unsuitable for caravans”;</li> <li>“unsuitable for trailers”;</li> <li>“unsuitable for articulated vehicles”.</li> </ul> <p>(2) Any of the following legends may be incorporated to show the route avoiding a hazard or prohibition indicated by the appropriate symbol referred to in item 31; avoiding a particular route; or avoiding a road where a sign to diagram 820 has been placed—</p> <ul style="list-style-type: none"> <li>“avoiding steep hill”;</li> <li>“avoiding swing bridge”;</li> <li>“avoiding lifting bridge”;</li> <li>“avoiding low bridge”;</li> <li>“avoiding weak bridge”;</li> <li>“avoiding ford”;</li> <li>“avoiding gated road”;</li> <li>“avoiding toll road”;</li> <li>“avoiding tunnel”;</li> <li>“avoiding town centre”;</li> <li>“avoiding level crossing”;</li> </ul>

**Status:** This is the original version (as it was originally made). This item of legislation is currently only available in its original format.

<i>(1)</i> <i>Item</i>	<i>(2)</i> <i>Diagram numbers</i>	<i>(3)</i> <i>Permitted variants</i>
		<p>“avoiding” plus a place name or other destination;                      “alternative route”;                      “alternative route for goods vehicles”;                      “alternative route for light vehicles only”;                      “alternative route for heavy vehicles”;                      “alternative route for HGVs”;                      “alternative route for high vehicles”;                      “alternative route for long vehicles”;                      “alternative route for wide vehicles”;                      “alternative route for buses”;                      “alternative route for caravans”;                      “alternative route for trailers”;                      “alternative route for articulated vehicles”;                      “alternative route for prohibited vehicles”;                      “route for goods vehicles”;                      “route for non-motorway traffic”.</p>
33.	<p>2004, 2005, 2107, 2109, 2112, 2113.1, 2201, 2202, 2203, 2208, 2209, 2215*, 2216, 2217, 2218, 2403.1, 2608, 2924, 2925, 2926, 2927, 2927.1</p> <p>*Symbols shown in diagrams T10 (light refreshment facilities), T11 (restaurant) and T12 (hotel or other overnight accommodation) shall not be used.</p>	<p>(3) The size of lettering on a sign shown in Schedule 7 Part II shall be as shown in diagram 2108 or 2132 as appropriate.</p>
		<p>(1) The symbol denoting the type of tourist destination may be omitted or varied to one of the symbols shown in Schedule 14 or other approved symbol, except that the symbols shown in diagrams T4 (picnic area), T5 (youth hostel), T6 (caravan site or park) and T7 (camping site or park), T10 (light refreshment facilities), T11 (restaurant) and T12 (hotel or other overnight</p>

**Status:** This is the original version (as it was originally made). This item of legislation is currently only available in its original format.

<i>(1)</i> <i>Item</i>	<i>(2)</i> <i>Diagram numbers</i>	<i>(3)</i> <i>Permitted variants</i>
34.	<p>2001, 2002, 2003, 2004, 2005, 2005.1, 2006, 2007, 2008, 2009, 2010.1, 2010.2, 2011, 2012, 2013, 2014, 2015, 2016, 2017, 2018, 2019, 2020, 2021, 2021.1, 2022, 2023, 2024, 2025, 2026, 2027, 2027.1, 2028, 2029, 2033, 2034, 2035, 2101, 2101.1, 2101.2, 2102, 2102.1, 2103, 2104, 2105.1, 2106.1, 2107, 2108, 2109, 2110, 2111, 2111.1, 2112, 2113, 2113.1, 2114, 2114.1, 2115, 2115.1, 2116, 2117, 2118, 2119, 2120, 2121, 2122, 2123, 2124, 2124.1, 2125, 2126, 2126.1, 2127, 2131, 2132, 2138, 2202, 2203, 2204, 2216, 2218, 2324, 2325, 2326, 2327, 2505, 2505.1, 2506, 2507, 2508, 2509.1, 2510, 2511, 2512, 2513, 2601.1, 2602.1, 2603, 2604, 2605, 2606, 2607, 2705, 2706, 2707, 2903*, 2904*, 2904.1*, 2905*, 2906*, 2908*, 2908.1*, 2909*, 2913, 2913.1**, 2913.2, 2913.3, 2913.4, 2914, 2914.1**, 2915*</p>	<p>accommodation) shall not be used on a motorway.</p> <p>(2) A symbol shown in Schedule 14 or other approved symbol denoting the type of tourist destination may be added where not shown in the diagram.</p> <p>(3) The symbol shall be reversed where appropriate.</p> <p>The following symbols (shown in the manner specified) may be added or omitted as appropriate—</p> <p>The white on red double arrow symbol indicating a railway station shown in diagram 2134. A white border shall be added around the symbol when placed on a green, brown, blue or black background on that part of the sign; The red circle and blue crossbar indicating a London Underground railway station shown in diagram 2133 or the red circle and red crossbar indicating a bus station or bus stop serving buses operated by or on behalf of or under agreement with Transport for London and shown in diagram 973.2. The symbols shall be shown on a white rectangular patch when placed on a green, brown, blue or black background on that part of the sign. Signs indicating bus stops referred to above may additionally show a bus stop code letter in white on a red circle. The red circle shall have a white border when placed on</p>
	<p>*In respect of symbol No. 1 and 10 only.</p>	
	<p>**In respect of symbol No. 1 and 10 only except when indicating a route other than a motorway.</p>	

**Status:** This is the original version (as it was originally made). This item of legislation is currently only available in its original format.

(1) Item	(2) Diagram numbers	(3) Permitted variants
		<p>a green, brown, blue or black background on that part of the sign;</p> <p>A symbol or logo representing a stopping place for tramcars or vehicles forming part of a light railway transit system, or boarding place for river services, each being operated by or on behalf of or under agreement with Transport for London. A white border or rectangular patch may be used to ensure adequate contrast between the colour of the symbol or logo and the background on that part of the sign;</p> <p>A symbol representing a Passenger Transport Executive. Where necessary a white border or rectangular patch may be used to ensure adequate contrast between the colour of the symbol and the background on that part of the sign;</p> <p>The parking symbol shown in diagram 2505 including any of the permitted variants indicated in item 4 in the box below that diagram. The parking symbol and any associated legend and symbol shall be shown on a white panel when placed on a green or brown background on that part of the sign. Where the parking symbol is shown by itself a white border shall be added when placed on a green or brown</p>

**Status:** This is the original version (as it was originally made). This item of legislation is currently only available in its original format.

<i>(1)</i> <i>Item</i>	<i>(2)</i> <i>Diagram numbers</i>	<i>(3)</i> <i>Permitted variants</i>
		<p>background on that part of the sign;</p> <p>The telephone symbol shown in diagram 2322. The symbol shall be coloured black when placed on a white or yellow background and be coloured white when placed on a green, brown, blue or black background on that part of the sign. The symbol shall be reversed where appropriate. The legend “Payphone” or “Cardphone” may be added;</p> <p>The disabled person symbol shown in diagram 2310.1. The symbol shall be shown on a black rectangle when placed on a white or yellow background on that part of the sign. The symbol shall be reversed where appropriate;</p> <p>The “WC” symbol denoting toilets shown in diagram 2323. The symbol shall be coloured black when placed on a white or yellow background and be coloured white when placed on a green, brown, blue or black background on that part of the sign;</p> <p>The “H” symbol and associated plate denoting hospital shown in diagram 2113; “A &amp; E” may be varied to “Minor injury unit”; “not 24 hrs” may be added to the plate. The legend on the plate may be varied to “No A&amp;E” in which case the background colour of both the “H” symbol</p>

**Status:** This is the original version (as it was originally made). This item of legislation is currently only available in its original format.

<i>(1)</i> <i>Item</i>	<i>(2)</i> <i>Diagram numbers</i>	<i>(3)</i> <i>Permitted variants</i>
		<p>and the plate shall be blue. The associated plate may be placed either below or to the right of the “H” symbol. The “H” symbol may be omitted when “A&amp;E” is varied to “Minor injury unit”. A white border shall be added around both the “H” symbol and the associated plate when placed on a green or black background on that part of the sign;</p> <p>The ferry boat symbol shown in diagram 2007 or 2120 as appropriate. The rear car symbol may be varied to the lorry symbol. The two car symbols may be omitted and either two lorry symbols or the legend “Pedestrian ferry” added on the boat symbol. The symbol shall be coloured black with white vehicles or legend when placed on a white or yellow background and be coloured white with black vehicles or legend when placed on a green, brown, blue or black background on that part of the sign. The name of the ferry or quay may be added above the boat symbol. The car and lorry symbols shall be reversed where appropriate with the lorry symbol to the rear of the car symbol;</p> <p>The white on blue “Park and Ride” symbol with the words “Park and Ride” as shown in diagram 2503 or as varied as indicated</p>



**Status:** This is the original version (as it was originally made). This item of legislation is currently only available in its original format.

(1) Item	(2) Diagram numbers	(3) Permitted variants
		<p>in item 4 in the box below that diagram, but without an arrow and without the indication of a distance. The symbol and its associated legend shall be shown in a white panel when placed on a green or brown background on that part of the sign;</p> <p>The symbol for a recycling centre shown in diagram 2139. The symbol shall be shown on a white rectangular patch when placed on a green, brown, blue or black background on that part of the sign;</p> <p>The symbol for “Shopmobility” on a black patch and the word “Shopmobility” as shown in diagrams 2137 and 2137.1. The word “Shopmobility” may be centred below the symbol. The black patch shall be omitted and the white symbol placed directly on that part of the sign with a green background with the word “Shopmobility” in white letters.</p>
35.	<p>2001, 2002, 2003, 2004, 2005, 2005.1, 2006, 2007, 2008, 2009, 2010.1, 2010.2, 2016, 2017, 2018, 2019, 2022, 2023, 2024, 2025, 2028, 2029, 2033, 2035, 2101*, 2102*, 2102.1*, 2103*, 2104*, 2105.1*, 2106.1*, 2107*, 2108*, 2109*, 2110*, 2111*, 2111.1*, 2112*, 2113*, 2113.1*, 2114*, 2115*, 2115.1*, 2118*, 2119*, 2120*, 2121*, 2122*, 2123*, 2124*, 2124.1*, 2126.1*, 2127*</p>	<p>(1) Where a route leads to a motorway service area, access to which is reached from a primary route or a non-primary route, the legend “Services” or a geographical name and “services” shall be shown on a blue panel. The blue panel shall have a white border when placed on a green background.</p> <p>(2) Where a route leads to services indicated by a sign shown in diagram 2313.1, 2313.3 or 2313.5, the legend</p>

*Status: This is the original version (as it was originally made). This item of legislation is currently only available in its original format.*

(1) Item	(2) Diagram numbers	(3) Permitted variants
	*Permitted variant (2) does not apply to these signs	“Services” or a geographical name and “services” shall be shown on a white panel.
36.	2001, 2002, 2003, 2005.1, 2007, 2008, 2009, 2011, 2012, 2014, 2015, 2016, 2017, 2019, 2020, 2022, 2024, 2025, 2033, 2101, 2101.1, 2101.2, 2102, 2103, 2104, 2105.1, 2106.1, 2107, 2108, 2109, 2111, 2112, 2113, 2113.1, 2114, 2115, 2116, 2117, 2118, 2119, 2120, 2121, 2124.1	The name of the junction may be indicated in a panel at the top of the sign as shown in diagram 2004, 2005, 2013, 2021, 2023 or 2110 provided a place name is not indicated as described in item 37.
37.	2001, 2002, 2003, 2004, 2005, 2005.1, 2008, 2009, 2019, 2022, 2023, 2024, 2033, 2101, 2102, 2103, 2104, 2105.1, 2106.1, 2107, 2108, 2109, 2110, 2111, 2112, 2113, 2113.1, 2114, 2118, 2119, 2120	Where the sign is situated at or near the boundary of a town, village or suburb, the name alone of that town, village or suburb may be indicated in a panel at the top of the sign as shown in diagram 2007, provided that a junction name is not shown. Where the sign is not on a primary route the name shall be in black capital letters on a white background.
38.	618, 618.1, 618.2, 618.3*, 618.3A* (in respect of the bottom panel), 620, 620.1, 636.2, 637.2*, 638.1*, 639*, 639.1B*, 640*, 640.2A*, 640.3*, 640.4*, 642.2A, 646, 650.1*, 650.2*, 650.3*, 660, 660.3, 660.4, 660.5, 660.6, 660.7, 661A, 661.1, 661.2A, 661.3A, 662, 663, 663.1, 665*, 667.1, 668.1, 961*, 962, 962.1, 962.2, 972, 974, 975, 2505, 2505.1, 2506, 2507, 2508, 2509.1, 2510, 2511, 2512, 2513, 7002A, 7002B, 7002.1, 7003.1, 7005	(1) References to a time limit, the time of day, the day of the week, the month of the year, or the year may be added, varied or omitted as appropriate. References to bank or public holidays may be included.  (2) Where a diagram in column (2) is marked with an asterisk the time of the day may be expressed by the phrase “At any time” or “at any time”, as appropriate. Where such a phrase is shown in the diagram, this may be varied to any other time of day.
39.	639.1B, 660, 660.3, 660.4, 660.5, 660.6, 660.7, 661A, 661.1, 661.2A, 661.3A, 661.4, 662, 663, 663.1	(1) A symbol, logo, number, letter or letters (capitals, lower case or both), or name identifying a parking zone or parking permit identification

**Status:** This is the original version (as it was originally made). This item of legislation is currently only available in its original format.

<i>(1)</i> <i>Item</i>	<i>(2)</i> <i>Diagram numbers</i>	<i>(3)</i> <i>Permitted variants</i>
40.	7003.1, 7006, 7006.1*, 7007.1  *Permitted variant (b) does not apply to this sign	<p>may be added or varied as appropriate.</p> <p>(2) The size of the code letter or letters and the code letter patch may be varied and may be in any contrasting colours.</p> <p>(3) The name of the traffic authority may be added.</p> <p>The words “Highways Agency” may be varied to—</p> <p>(a) “The National Assembly for Wales” or “The Scottish Executive”; or</p> <p>(b) the name of the appropriate traffic authority in England or Wales or roads authority in Scotland.</p>
41.	781	<p>The Highways Agency logo shall be varied accordingly and any appropriate style of lettering used, or omitted.</p> <p>The number of bells may be increased or decreased according to the width of the road over which the sign is placed. The colour of the bells may be varied.</p>
42.	7201, 7201.1, 7210, 7211.1, 7212, 7213, 7214, 7215, 7216, 7217, 7218, 7220, 7221, 7230, 7231, 7232, 7233, 7234, 7235, 7236, 7237, 7238, 7239, 7240	Diagrams 7280 to 7284.1 may be incorporated or omitted as appropriate.
43.	7201, 7210, 7211.1, 7212, 7213, 7214, 7215, 7216, 7217, 7218, 7220, 7221, 7230, 7231, 7232, 7233, 7234, 7235, 7236, 7237, 7238, 7239, 7240	<p>(1) Diagrams 7285 and 7286 may be incorporated or omitted as appropriate.</p> <p>(2) The legend “only” may be shown below the route number in the size and manner shown in diagram 7230.</p> <p>(3) Two or more adjacent lanes may have a common route number, with or without the legend “only” alongside; the route number being placed above a horizontal bar, which in</p>

**Status:** This is the original version (as it was originally made). This item of legislation is currently only available in its original format.

<i>(1)</i> <i>Item</i>	<i>(2)</i> <i>Diagram numbers</i>	<i>(3)</i> <i>Permitted variants</i>
		turn is placed above any other incorporated diagram (7280 to 7284.1) in the manner shown in diagram 7201.
44.	7201	Diagram 7287 may be incorporated.
45.	7201.1	Diagram 7288 may be incorporated.
46.	515.1, 515.1A	The number of elements making up the sign face may be varied.

## SCHEDULE 17

Regulation 18

## ILLUMINATION OF SIGNS

<i>(1)</i> <i>Item</i>	<i>(2)</i> <i>Diagram numbers</i>	<i>(3)</i> <i>Method of illumination</i>
1.	501, 504.1*, 505.1*, 506.1*, 507.1*, 508.1*, 509.1*, 510*, 512*, 512.1*, 512.2*, 513*, 516*, 517*, 520, 521*, 522*, 523.1*, 524.1*, 528*, 529*, 529.1*, 530, 531.1, 532.2 (in respect of the triangle symbols), 532.3 (in respect of the triangle symbols), 543, 544, 544.1, 544.2, 545*, 555, 557.1*, 601.1, 602, 606 (other than when used as described in item 6 or item 7), 609, 610 (other than when used as described in item 7), 611 (other than when used as described in item 7), 611.1, 612 (other than when used as described in item 6), 613 (other than when used as described in item 6), 614 (other than when used as described in item 6), 615, 616 (other than when used as described in item 7), 617 (other than when used with 618), 618.2, 618.3, 618.3A, 618.4, 619, 619.1, 619.2, 622.1A, 622.2, 622.4, 622.7, 622.8,	<p>(1) Subject to paragraphs (2) and (3) the signs shall be reflectorised in accordance with the provisions of regulation 19.</p> <p>(2) Subject to paragraph (3), where the sign is erected on a road within 50 metres of any lamp lit by electricity which forms part of a system of street-lighting for that road furnished by means of at least three such lamps placed not more than 183 metres (in Scotland 185 metres) apart, it shall be illuminated by a means of internal or external lighting either for so long as that system is illuminated, or throughout the hours of darkness and may also be reflectorised.</p> <p>(3) A sign to which this paragraph applies shall be illuminated as mentioned in paragraph (1) or (2).</p> <p>(4) Paragraph (3) applies to a sign erected as mentioned in paragraph (2) which falls</p>

**Status:** This is the original version (as it was originally made). This item of legislation is currently only available in its original format.

<i>(1)</i> <i>Item</i>	<i>(2)</i> <i>Diagram numbers</i>	<i>(3)</i> <i>Method of illumination</i>
	626.2A, 627.1, 629, 629A, 629.1, 629.2, 629.2A, 632, 642 (when used as a terminal sign), 652, 770, 771, 772, 779, 782, 784.1, 790, 950*, 952, 953, 953.1, 2901, 2902, 2902.1, 2908, 2908.1, 2909, 2913.4, 2930, 2931, 5010, 5011, 7001, 7001.3, 7004, 7005, 7006, 7009, 7010.1, 7011, 7011.1, 7012, 7013, 7027, 7201, 7201.1, 7202, 7203, 7203.1, 7204, 7205, 7206, 7207, 7208, 7210, 7211.1, 7212, 7213, 7214, 7215, 7216, 7217, 7218, 7220, 7221, 7230, 7231, 7232, 7233, 7234, 7235, 7236, 7237, 7238, 7239, 7240, 7241, 7242, 7250, 7251, 7252, 7253, 7254, 7255, 7256, 7260, 7261, 7262, 7263, 7264, 7270, 7271, 7272, 7274, 7275, 7290, 7291, 7292, 7293, 7294	within any of the following descriptions— <ul style="list-style-type: none"> <li>(a) a sign placed temporarily— <ul style="list-style-type: none"> <li>(i) for the purposes of a temporary statutory provision (other than in connection with road works);</li> <li>(ii) by reason of an emergency; or</li> <li>(iii) by reason of the execution of works, or of any obstruction, on a road subject to a speed limit (other than a temporary speed limit) of 40 mph or less;</li> </ul> </li> <li>(b) a sign marked with an asterisk in column (2) when placed on a single carriageway road which is not a principal or trunk road and is subject to a speed limit of 30mph or less;</li> <li>(c) the sign shown in diagram 652 when placed on a road more than 50 metres from a junction with another road from which traffic can approach it;</li> <li>(d) the sign shown in diagram 7004 or 7005, in either case when varied to omit the sign shown in</li> </ul>

**Status:** This is the original version (as it was originally made). This item of legislation is currently only available in its original format.

(1) Item	(2) Diagram numbers	(3) Method of illumination
		diagram 7001 and the distance plate.
2.	2711	The sign shall be internally illuminated.
3.	955, 956, 957, other than when used as described in item 7	<p>(1) Where the sign is a terminal sign and is erected on a road within 50 metres of any lamp lit by electricity which forms part of a system of street-lighting for that road furnished by means of at least three such lamps placed not more than 183 metres (in Scotland 185 metres) apart, that sign shall be illuminated by a means of internal or external lighting either for so long as that system is illuminated, or throughout the hours of darkness.</p> <p>(2) Where the sign is erected in such a manner that it is not required to be illuminated throughout the hours of darkness by a means of internal or external lighting, it shall be reflectorised in accordance with regulation 19.</p>
4.	515, 515.1, 515.1A, 528.1, 548, 549, 550, 550.1, 550.2, 551, 551.1, 551.2, 552, 553.1, 554, 554.1, 554.2, 555.1, 556, 556.1, 557, 558, 558.1, 559, 562, 574, 581, 582, 583, 584, 633, 642 (when used other than as a terminal sign), 642.2A, 642.3, 646, 647, 650.1, 663, 663.1, 664, 665, 666, 774, 775, 777, 783, 785.1, 786, 787, 788, 789, 789.1, 789.2, 801, 811, 816, 817, 818, 818.1, 818.1A, 818.2, 818.3, 818.4, 820, 820.1, 821, 822, 823, 824, 825, 827.1, 827.2, 827.3, 829.1, 829.2, 829.3, 829.4, 829.5, 829.6, 830, 830.1, 830.2, 830.3, 831, 831.2, 832, 832.1A, 832.2A, 832.3, 832.4, 832.5, 832.6, 832.7, 832.8, 832.9, 832.10A, 868, 868.1,	The sign may be illuminated by a means of internal or external lighting but, if not so illuminated throughout the hours of darkness, it shall be reflectorised in accordance with regulation 19.

**Status:** This is the original version (as it was originally made). This item of legislation is currently only available in its original format.

(1) Item	(2) Diagram numbers	(3) Method of illumination
	872.1, 873, 874, 875, 876, 877, 878, 879, 880, 881, 882, 883, 951 (other than when used as described in item 7), 958, 958.1, 959, 959.1, 960, 960.1, 961, 962, 962.1, 962.2, 964, 969, 974, 975, 2001, 2002, 2003, 2004, 2005, 2005.1, 2006, 2007, 2008, 2009, 2010.1, 2010.2, 2011, 2012, 2013, 2014, 2015, 2016, 2017, 2018, 2019, 2020, 2021, 2021.1, 2022, 2023, 2024, 2025, 2026, 2027, 2027.1, 2028, 2029, 2030, 2030.1, 2031, 2032, 2033, 2034, 2035, 2101, 2101.1, 2101.2, 2102, 2102.1, 2103, 2104, 2105.1, 2106.1, 2107, 2108, 2109, 2110, 2111, 2111.1, 2112, 2113, 2113.1, 2114, 2114.1, 2115, 2115.1, 2116, 2117, 2118, 2119, 2120, 2121, 2122, 2123, 2124, 2124.1, 2125, 2126, 2126.1, 2127, 2128, 2129, 2130, 2131, 2132, 2133, 2134, 2135, 2136, 2137, 2137.1, 2138, 2139, 2140, 2301, 2302, 2303, 2304, 2307, 2308.1, 2309.1, 2310.1, 2311.1, 2311.2, 2313.1, 2313.2, 2313.3, 2313.4, 2313.5, 2313.6, 2314.1, 2314.2, 2324, 2325, 2326, 2327, 2328, 2329, 2330, 2501, 2502, 2503, 2504, 2505, 2505.1, 2506, 2507, 2508, 2509.1, 2510, 2511, 2512, 2513, 2702, 2703, 2704, 2705, 2706, 2707, 2708, 2709, 2710, 2713.1, 2716, 2803, 2804, 2805, 2806, 2806.1, 2903, 2904, 2904.1, 2905, 2906, 2910, 2910.1, 2911, 2912, 2913, 2913.1, 2913.2, 2913.3, 2914, 2914.1, 2915, 2917, 2918, 2918.1, 2919.1, 2920.1, 2921, 2921.1, 2922, 2924, 2925, 2926, 2927, 2927.1, 2928, 2929, 2929.1, 2932, 2933, 2934, 4005 (in respect of	

**Status:** This is the original version (as it was originally made). This item of legislation is currently only available in its original format.

<i>(1)</i> <i>Item</i>	<i>(2)</i> <i>Diagram numbers</i>	<i>(3)</i> <i>Method of illumination</i>
5.	the warning sign), 5012, 5013, 5014, 5015, 7002A, 7002B, 7002.1, 7003.1, 7006.1, 7014, 7015, 7019, 7020, 7025, 7026, 7028, 7029, 7032, 7104, 7105, 7301, 7302, 7303, 7304, 7305, 7306, 7307, 7402, 7403  7023, 7024, 7031	The sign shall be illuminated by a means of internal or external lighting throughout the hours of darkness.
6.	606, 612, 613, 614, 954.5, 954.6, 954.7	Where the sign is fixed to light signals prescribed by regulation 33, it shall be illuminated by a means of internal lighting at all times except when the light signals to which it is fixed are being maintained or repaired.
7.	606, 610, 611, 616, 951, 955, 956, 957	Where the sign is mounted in a bollard fitted with a means of lighting it internally, the sign shall be illuminated throughout the hours of darkness by that means of internal lighting.
8.	502, 503, 511, 513.1, 513.2, 518, 519, 525, 526, 527, 530.1, 531.2, 543.1, 546, 547.1, 547.2, 547.3, 547.4, 547.7, 547.8, 548.1, 553, 553.2, 554.3, 556.2, 557.2, 557.3, 557.4, 558.2, 563, 563.1, 570, 572, 573, 575, 583.1, 584.1, 607, 608, 615.1, 618, 618.1, 620, 620.1, 622.9, 645, 773, 778, 778.1, 780A, 780.1A, 780.2A, 804.1, 804.2, 804.3, 804.4, 811.1, 817.2, 950.1, 953.2, 954, 954.2, 954.3, 954.4, 2602.3, 7001.1, 7001.2, 7021, 7022, 7030, 7209	See regulation 20.
9.	530.2, 532.2 and 532.3 in respect of parts of the signs other than the triangle symbols, 617 (when used with 618), 622.5, 622.6, 625.1, 636, 636.1, 636.2, 637.1, 637.2, 637.3, 638, 638.1, 639,	The sign or plate may be left unlit, or be illuminated either by means of internal or external lighting or by the use of retroreflecting material.



**Status:** This is the original version (as it was originally made). This item of legislation is currently only available in its original format.

(1) Item	(2) Diagram numbers	(3) Method of illumination
	639.1B, 640, 640.1, 640.2A, 640.3, 640.4, 640.5, 650.2, 650.3, 651, 660, 660.3, 660.4, 660.5, 660.6, 660.7, 661A, 661.1, 661.2A, 661.3A, 661.4, 662, 667, 667.1, 667.2, 668, 668.1, 668.2, 810, 814.1, 814.2, 814.3, 814.4, 816.1, 826, 826.1, 833, 834, 835, 836, 857, 857.1, 864.1, 865, 953.3, 963, 963.1, 963.2, 963.3, 965, 966, 967, 968, 968.1, 970, 971, 972, 973.2, 973.3, 976, 2141, 2201, 2202, 2203, 2204, 2205, 2208, 2209, 2210, 2211, 2212, 2213, 2214, 2215, 2216, 2217, 2218, 2305, 2306, 2322, 2323, 2401, 2402.1, 2403.1, 2601.1, 2601.2, 2602.1, 2602.2, 2603, 2604, 2605, 2606, 2607, 2608, 2609, 2610, 2610.1, 2610.2, 2701, 2701.1, 2712, 2713, 2717, 2801, 2802, 7007.1, 7008, 7016, 7017, 7018, 7018.1, 7404	
10.	670, 671, 672, 673	<p>(1) Where the sign is a terminal sign and is erected on a trunk or principal road within 50 metres of a street lamp lit by electricity, it shall throughout the hours of darkness—</p> <ul style="list-style-type: none"> <li>(a) be continuously illuminated by means of internal or external lighting and may also be reflectorised; or</li> <li>(b) while the street lamp is lit, be continuously illuminated by means of external lighting and shall also be reflectorised.</li> </ul> <p>(2) If any sign is required to be illuminated in the manner and at the times described in paragraph (1) above—</p> <ul style="list-style-type: none"> <li>(a) every sign shown in the same diagram as</li> </ul>

**Status:** This is the original version (as it was originally made). This item of legislation is currently only available in its original format.

<i>(1)</i> <i>Item</i>	<i>(2)</i> <i>Diagram numbers</i>	<i>(3)</i> <i>Method of illumination</i>
		<p>the first-mentioned sign which is erected at or near the same point on the road or the same junction for the same purpose as the first-mentioned sign shall be continuously illuminated throughout the same period by the same means of lighting as the first-mentioned sign; and</p> <p>(b) if any of the signs is reflectorised, every other such sign shall be similarly illuminated.</p>
11.	670, 671, 672, 673, 674, 675	<p>If the sign is not required by item 10 to be illuminated by lighting throughout the hours of darkness or throughout such hours while a street lamp is lit, it may be illuminated by a means of internal or external lighting; but if not so illuminated, it shall be reflectorised in accordance with regulation 19.</p> <p>Paragraph (2) of item 10 shall apply as if the sign were a sign required by paragraph (1) of item 10 to be illuminated by lighting throughout the hours of darkness or throughout those hours while a street lamp is lit.</p>
12.	1001, 1001.1, 1001.2, 1001.3, 1002.1, 1003, 1003.1, 1003.2, 1003.3, 1003.4, 1004, 1004.1, 1005, 1005.1, 1008, 1008.1, 1009, 1010, 1012.1, 1012.2, 1012.3, 1013.1, 1013.3, 1013.4, 1014, 1017, 1018.1, 1019, 1020.1, 1022, 1023, 1024, 1024.1, 1025.1, 1025.3,	See regulation 31.

**Status:** This is the original version (as it was originally made). This item of legislation is currently only available in its original format.

(1) Item	(2) Diagram numbers	(3) Method of illumination
	1025.4, 1026, 1026.1, 1027.1, 1028.2, 1028.3, 1028.4, 1029, 1032, 1033, 1035, 1036.1, 1036.2, 1037.1, 1038, 1038.1, 1039, 1040, 1040.2, 1040.3, 1040.4, 1040.5, 1041, 1041.1, 1042, 1042.1, 1043, 1044, 1045, 1046, 1048, 1048.1, 1048.2, 1048.3, 1048.4, 1049, 1049.1, 1050, 1055.1, 1055.2, 1057, 1058, 1058.1, 1059, 1062, 1063, 1064, 1065, 1066	
13.	560, 561	See regulation 21.
14.	776	When activated, the sign shall be illuminated by an intermittent red light flashing at a rate of not less than 54 nor more than 90 flashes per minute.
15.	515.2, 2714, 2715, 3014 (in respect of the backing board), 7031	<p>(1) The parts of the sign coloured other than black or orange shall be reflectorised in accordance with regulation 19.</p> <p>(2) The parts coloured orange of the signs in diagrams 2714 and 2715 may be so illuminated and may be fluorescent.</p> <p>(3) The part of the sign in diagram 7031 coloured yellow shall be fluorescent, except as provided in regulation 19(4). The part of the sign in diagram 7031 coloured red may be fluorescent.</p>
16.	7101.1, 7102, 7103	See regulation 56.

## SCHEDULE 18

Regulation 4

## INTERPRETATION OF “UNLADEN VEHICLE”

1. In these Regulations “unladen vehicle” means, subject to paragraph 3—
- a motor vehicle not drawing a trailer or otherwise forming part of a combination of vehicles; or
  - a combination of vehicles comprising one motor vehicle drawing one or more trailers,

*Status: This is the original version (as it was originally made). This item of legislation is currently only available in its original format.*

in relation to which the conditions specified in paragraph 2 below are satisfied.

2. The conditions are—
  - (a) that the motor vehicle is a motor car, a heavy motor car, or a motor tractor;
  - (b) that no goods or burden are being carried in the motor vehicle or combination of vehicles; and
  - (c) that not more than 2 persons (excluding the driver) are being carried in the motor vehicle or combination of vehicles.
3. For the purposes of this Schedule, the following are to be deemed not to constitute goods or burden—
  - (a) in the case of a motor vehicle constructed or adapted for use and used for the conveyance of a machine or device which is built in as part of the vehicle, that machine or device and any articles used in connection with it;
  - (b) water, fuel or accumulators used for the purpose of the supply of power for the propulsion of a vehicle or, as the case may be, of any vehicle by which a trailer is drawn, and loose tools and loose equipment.

## SCHEDULE 19

Regulation 29

### BUS STOP AND BUS STAND CLEARWAYS AND BOX JUNCTIONS

## PART I

### SIGNIFICANCE OF BUS STOP AND BUS STAND CLEARWAY MARKINGS

#### **Interpretation of Part I of Schedule**

1. For the purposes of this Part of this Schedule—
  - (a) “clearway” means an area of carriageway bounded by the continuous and broken straight yellow lines comprised in the road marking in diagram 1025.1, 1025.3 or 1025.4 and “bus stop clearway” means a clearway on which the words “BUS STOP” are marked; and
  - (b) a vehicle shall be taken to have stopped within a clearway if—
    - (i) any point in the clearway is below the vehicle or its load (if any); and
    - (ii) the vehicle is stationary.

#### **Prohibition conveyed by road markings**

2. The road markings in diagrams 1025.1, 1025.3 and 1025.4 shall each convey the prohibition that, subject to the exceptions specified in paragraphs 3 and 4, no person driving a vehicle shall cause it to stop within the clearway—
  - (a) at any time, if the sign shown in diagram 974 or 975 placed in conjunction with the markings is varied so as to omit the reference to times of day; or
  - (b) in any other case, during the period specified on that sign.

### Exceptions in favour of buses

3. Nothing in paragraph 2 applies to the driver of a bus being used in the provision of a local service who causes the bus to stop within the clearway for so long as may be necessary—

- (a) to maintain the published timetable for the service (provided, in the case of a bus stop clearway, the bus is not stopped within the clearway for a period exceeding two minutes);
- (b) to enable passengers to board or alight from the bus; or
- (c) to enable the crew of the bus to be changed.

### Other exceptions

4.—(1) Nothing in paragraph 2 applies in relation to—

- (a) a vehicle being used for fire brigade, ambulance or police purposes;
- (b) anything done with the permission or at the direction of—
  - (i) a constable in uniform;
  - (ii) a traffic warden; or
  - (iii) where the clearway is in a special parking area designated under Part II of the Road Traffic Act 1991 or Schedule 3 to that Act, a parking attendant appointed under section 63A of the 1984 Act<sup>(41)</sup>;
- (c) a vehicle which is prevented from proceeding by circumstances beyond the driver's control or which has to be stopped in order to avoid injury or damage to persons or property;
- (d) a taxi which is stationary only for so long as may be reasonably necessary for a passenger to board or alight and to load or unload any luggage of the passenger;
- (e) a marked vehicle which, whilst used by a universal service provider in the course of the provision of a universal postal service, is stationary only for so long as may be reasonably necessary for postal packets to be collected;
- (f) a vehicle driven by a person whilst being trained to drive a bus operating local services who, as part of his training, stops the vehicle within a clearway for no longer than necessary to simulate the stopping of a bus at a bus stop for the purpose of picking up and setting down passengers;
- (g) a vehicle which is stationary in order that it may be used for one or more of the purposes specified in paragraph 5 and which cannot be used for such a purpose without stopping in the clearway.

(2) In sub-paragraph (1)(e) the expressions “universal service provider”, “provision of a universal postal service” and “postal packet” shall bear the same meanings as in the Postal Services Act 2000<sup>(42)</sup>.

### Permitted purposes

5. The purposes referred to in paragraph 4(g) are—

- (a) any operation involving building, demolition or excavation;
- (b) the removal of any obstruction to traffic;
- (c) the maintenance, improvement or reconstruction of a road;

---

<sup>(41)</sup> Section 63A was inserted by the Road Traffic Act 1991 section 44(1) and was amended by the Greater London Authority Act 1999 (c. 29) section 289.

<sup>(42)</sup> 2000 c. 26.

*Status: This is the original version (as it was originally made). This item of legislation is currently only available in its original format.*

- (d) constructing, improving, maintaining or cleaning any street furniture including bus stop infrastructure; or
- (e) the laying, erection, alteration, repair or cleaning of any sewer or of any main, pipe or apparatus for the supply of gas, water or electricity, or of any telecommunications apparatus kept installed for the purposes of a telecommunications code system or of any other telecommunications apparatus lawfully kept installed in any position.

## PART II

### SIGNIFICANCE OF BOX JUNCTION MARKINGS

#### **Interpretation of Part II of Schedule**

6. In this Part of this Schedule—

- (a) “box junction” means the area of carriageway marked with yellow cross-hatching at a junction between two or more roads on which there has been placed the road marking shown in diagram 1043 or 1044; and
- (b) a reference (however expressed) to a vehicle which is stationary or stops within a box junction includes a vehicle which is stationary whilst part of it is within the box junction.

#### **Prohibition conveyed by markings in diagram 1043 or 1044**

7.—(1) Except when placed in the circumstances described in paragraph 8, the road markings shown in diagrams 1043 and 1044 shall each convey the prohibition that no person shall cause a vehicle to enter the box junction so that the vehicle has to stop within the box junction due to the presence of stationary vehicles.

(2) The prohibition in sub-paragraph (1) does not apply to any person—

- (a) who causes a vehicle to enter the box junction (other than a box junction at a roundabout) for the purpose of turning right; and
- (b) stops it within the box junction for so long as it is prevented from completing the right turn by oncoming vehicles or other vehicles which are stationary whilst waiting to complete a right turn.

#### **Prohibition conveyed when markings are placed in conjunction with signs in diagrams 615 and 811**

8. When the road marking shown in diagram 1043 or 1044 is placed in conjunction with the signs shown in diagrams 615 and 811 on an area of carriageway which is less than 4.5 metres wide at its narrowest point, the road marking shall convey the prohibition that no person shall cause a vehicle to enter the box junction so that the vehicle has to stop within the box junction due to the presence of oncoming vehicles or other stationary vehicles beyond the box junction.

## PART II

### THE TRAFFIC SIGNS GENERAL DIRECTIONS 2002

#### **Citation and commencement**

1. This Part of this Instrument—

- (a) may be cited—
  - (i) as the Traffic Signs General Directions 2002, and
  - (ii) together with Part I above, as the Traffic Signs Regulations and General Directions 2002; and
- (b) shall come into force on 31st January 2003.

## **Revocations**

2. The Traffic Signs General Directions 1994(43), the Traffic Signs General (Amendment) Directions 1995(44), the Traffic Signs General (Amendment) (No. 2) Directions 1995(45) and the Traffic Signs General (Amendment) Directions 1999(46) are hereby revoked.

## **Interpretation—general**

- 3.—(1) In these Directions—
- (a) “one-way road” has the meaning given in paragraph 1 of the Schedule;
  - (b) “the Regulations” means the Traffic Signs Regulations 2002(47); and
  - (c) the expressions listed in paragraph (2) have the same meaning as in the Regulations.
- (2) Those expressions are—
- “the 1984 Act”;
  - “central reservation”;
  - “contra-flow”;
  - “controlled parking zone”;
  - “cycle lane”;
  - “cycle track”;
  - “dual carriageway road”;
  - “EEA Standard”;
  - “equestrian crossing”;
  - “junction”;
  - “level crossing”;
  - “maximum gross weight”;
  - “motorway”;
  - “mph”;
  - “non-primary route”;
  - “pedal cycle”;
  - “pedestrian zone”;
  - “plate”;
  - “primary route”;
  - “primary signals”;

---

(43) Part II of S.I. 1994/1519.

(44) S.I. 1995/2769.

(45) Part II of S.I. 1995/3107.

(46) S.I. 1999/1723.

(47) Part I of this Instrument.

*Status: This is the original version (as it was originally made). This item of legislation is currently only available in its original format.*

“principal road”;  
“reflectorised”;  
“retroreflecting material”;  
“road marking”;  
“route”;  
“school crossing place”;  
“secondary signals”;  
“sign”;  
“signal-controlled crossing facility”;  
“signal-controlled pedestrian facility”;  
“speed limit” and “national speed limit”;  
“stud”;  
“temporary statutory provision”;  
“traffic lane”;  
“Toucan crossing”;  
“variable message sign”;  
“Zebra crossing”; and  
“zig-zag line”.

### **Interpretation of references**

4. In these Directions, unless it is expressly provided otherwise or the context otherwise requires—

- (a) a reference to a numbered direction is a reference to the direction so numbered in these Directions;
- (b) a reference to a numbered paragraph is a reference to the paragraph so numbered in the direction in which the reference occurs;
- (c) a reference to a sub-paragraph followed by a number or letter is a reference to the sub-paragraph bearing that number or letter in the direction in which the reference occurs;
- (d) a reference to a numbered diagram is a reference to the diagram so numbered in a Schedule to the Regulations;
- (e) a reference to a sign shown in a diagram in a Schedule to the Regulations includes a reference to that sign as varied in accordance with the Regulations;
- (f) a reference to a numbered regulation or Schedule is a reference to the regulation of, or to the Schedule to, the Regulations so numbered; and
- (g) in any direction which includes a table, references to a table are to the table, or in the case of a numbered table to the table so numbered, in that direction.

### **Saving**

5. Any sign, which immediately before the coming into force of these Directions was—
- (a) placed on or near any road in conformity with the Traffic Signs General Directions 1994; or
  - (b) was by virtue of those Directions to be treated as placed in conformity with those Directions,



**Status:** This is the original version (as it was originally made). This item of legislation is currently only available in its original format.

shall, so long as it would have continued to conform or be treated as conforming with those Directions if they had not been revoked, be treated as if placed in conformity with these Directions, notwithstanding any provision of these Directions to the contrary.

### Sign to be placed only at sites approved by the Secretary of State

6. The sign shown in diagram 601.1 shall not be placed for the first time at any site except with the approval of the Secretary of State, the Scottish Ministers or the National Assembly for Wales.

### Signs to be placed only to indicate the effect of a statutory prohibition

7.—(1) Except as provided by paragraph (3), the signs to which this paragraph applies may be placed on or near a road only to indicate the effect of an Act, order, regulation, byelaw or notice (“the effect of a statutory provision”) which prohibits or restricts the use of the road by traffic.

(2) Paragraph (1) applies to—

- (a) the signs shown in diagrams 606, 607, 609, 612, 613, 614, 616, 617, 618, 618.1, 618.2, 618.3, 618.3A, 618.4, 619, 619.1, 619.2, 620, 620.1, 622.1A, 622.2, 622.4, 622.5, 622.6, 622.7, 622.8, 622.9, 625.1, 626.2A, 627.1, 629, 629A, 629.1, 629.2, 629.2A, 632, 636, 636.1, 636.2, 637.1, 637.2, 637.3, 638, 638.1, 639, 639.1B, 640, 640.2A, 640.3, 640.4, 640.5, 642, 642.2A, 642.3, 646, 647, 650.1, 650.2, 650.3, 651, 652, 660, 660.3, 660.4, 660.5, 660.6, 660.7, 661A, 661.1, 661.2A, 661.3A, 661.4, 662, 663, 663.1, 664, 665, 666, 667, 667.1, 667.2, 668, 668.1, 668.2, 670, 671, 672, 673, 674, 675, 804.1, 804.2, 804.3, 804.4, 810, 818.2, 818.3, 818.4, 951, 952, 953, 953.1, 953.2, 954, 954.2, 954.3, 954.4, 954.5, 954.6, 954.7, 955, 956, 957, 958, 958.1, 959, 959.1, 960, 960.1, 961, 962, 962.2, 963, 963.2, 963.3, 964, 969, 1017, 1018.1, 1019, 1020.1, 1028.2, 1028.3 (except when used in conjunction with the sign shown in diagram 786), 1028.4, 1032, 1033, 1036.1, 1036.2, 1037.1, 1046, 1048, 1048.1, 1048.2, 1048.3, 1048.4, 1049, 1049.1, 1050, 1065, 2003, 2007, 2009, 2010.1, 2010.2, 2107, 2108, 2123, 2124, 5001.1, 5001.2, 5003, 5003.1, 5005, 5005.1, 7201, 7201.1, 7203.1, 7204, 7207, 7210, 7211.1, 7212, 7213, 7214, 7215, 7216, 7217, 7218, 7220, 7230, 7231, 7232, 7233, 7234, 7235, 7260, 7261, 7282, 7283, 7283.1, 7284, 7284.1 and 7290; and
- (b) any sign which, by virtue of regulation 17 and item 31 of Schedule 16, incorporates as a symbol a sign shown in a diagram specified in sub-paragraph (a).

(3) A sign shown in a diagram specified in an item in column (2) of the Table may be placed at a site or in circumstances specified in column (3) of that item notwithstanding that it does not at that site or in those circumstances indicate the effect of a statutory provision.

**Table**

<i>(1)</i> <i>Item</i>	<i>(2)</i> <i>Diagram</i>	<i>(3)</i> <i>Site or circumstances</i>
1.	606	On the central island of a roundabout or in combination with a plate of the type shown in diagram 608
2.	609	On a road approaching its junction with a dual carriageway road whether or not in combination with a plate of the type shown in diagram 608

*Status: This is the original version (as it was originally made). This item of legislation is currently only available in its original format.*

<i>(1)</i> <i>Item</i>	<i>(2)</i> <i>Diagram</i>	<i>(3)</i> <i>Site or circumstances</i>
3.	616, 1046	At a site which has been approved by the Secretary of State
4.	629.2, 629.2A	On— (a) a road which passes under or through a bridge, tunnel or other structure which limits the height of vehicles using that road; or (b) any such bridge, tunnel or other structure
5.	2003, 2007, 2009, 2107, 2108 or a sign to which paragraph (1) applies by virtue of paragraph (2)(b)	When— (a) including a symbol representing diagram 629.2 or 629.2A in the circumstances specified in item 4; or (b) not including a symbol representing a sign to which paragraph (1) applies
6.	818.2, 818.3, 818.4	When placed in the circumstances specified in item 4 above to indicate that the prohibition indicated by the sign shown in diagram 629.2 or 629.2A is ahead

(4) The sign shown in diagram 626.2A may be placed only to indicate the effect of a statutory provision which restricts the use of a road carried by a bridge or other structure—

- (a) in the case of vehicles required to be marked with their maximum gross weight, to any vehicle with a maximum gross weight not exceeding that indicated on the sign; or
- (b) in the case of vehicles not required to be marked with their maximum gross weight but required to be marked with their unladen weight, to any vehicle with an unladen weight not exceeding the maximum gross weight indicated on the sign.

**The placing of certain signs to indicate the beginning of a restriction, requirement, prohibition or speed limit**

8.—(1) This direction applies to the signs shown in diagrams 616, 617, 618, 618.1, 618.2, 618.3, 618.3A, 619, 619.1, 619.2, 620, 620.1, 622.1A, 622.4, 622.5, 622.6, 622.7, 622.8, 622.9, 625.1, 626.2A, 627.1, 629, 629A, 629.1, 629.2, 629.2A, 632, 642, 646, 663, 663.1, 665, 667, 667.1, 668, 668.1, 670, 672, 674, 951, 952, 953, 953.1, 955, 956 and 957.

(2) In accordance with the following provisions of this direction and the provisions of direction 9, appropriate signs to which this direction applies shall be placed to indicate the point at which a restriction, requirement, prohibition or speed limit applying to traffic on a road (in this direction and in direction 9 called “the relevant road”) begins.

(3) Subject to paragraphs (4), (5) and (6) and to direction 9, a sign to which this direction applies shall be placed on the relevant road at or as near as practicable to the point referred to in paragraph (2)

- (a) where the relevant road has only one carriageway, on each side of that carriageway; or
  - (b) where the relevant road has more than one carriageway, on each side of each carriageway in relation to which the restriction, requirement, prohibition or speed limit begins.
- (4) Where the relevant road has one carriageway, then signs to which this direction applies need only be placed on one side of the relevant road to indicate the point at which a restriction, requirement, prohibition (but not a speed limit) begins in the following cases—
- (a) where the restriction, requirement or prohibition applies only to traffic on one side of the relevant road; or
  - (b) at a junction where—
    - (i) traffic proceeding on another road on which it is permitted to proceed only in one direction turns into the relevant road; or
    - (ii) the carriageway of the relevant road is less than 5 metres wide and the sign is so placed that its centre is within 2 metres of the edge of the carriageway.
- (5) Where a length of road which passes under or through a bridge, tunnel or other structure is subject to a prohibition on vehicles exceeding a particular height, the sign shown in diagram 629.2 or 629.2A may be placed on the bridge, tunnel or other structure to indicate the prohibition in addition to or instead of the signs required to be placed by paragraph (3).
- (6) Paragraphs (3) and (4) shall not apply to the signs shown in diagrams 667, 667.1, 668 and 668.1 which shall be placed on the side of the carriageway on which parking on a verge or footway is permitted and as near as is practicable to the point at which the length of the verge or footway concerned begins.

### **Beginning of a speed limit—further provisions**

9.—(1) Direction 8(3) does not apply where a speed limit in force on the relevant road begins—

- (a) at a point where the relevant road begins, being a point where it has no junction with another road; or
- (b) at a point where the relevant road has a junction with another road and the same speed limit is in force on both roads.

(2) This paragraph applies where the relevant road has a junction (“the junction”) with the side of another road (“the other road”) and a maximum speed limit is in force on the other road which is different from the speed limit in force on the relevant road.

(3) Where paragraph (2) applies, it is sufficient compliance with direction 8(2), for the purpose of indicating the beginning of the speed limit on the relevant road to traffic entering it from the other road, if the sign shown in diagram 670, 674 or 675 is placed not further than 20 metres from the junction, on the left hand or near side of the carriageway of the relevant road as viewed in the direction of travel of such traffic or, where the relevant road is a dual carriageway road, on the left hand or near side of the carriageway by which traffic may pass into the relevant road from the other road.

(4) Where paragraph (2) applies, for the purpose of indicating the speed limit in force on the other road to traffic entering that road from the relevant road, the sign shown in diagram 670, 674 or 675 shall (subject to paragraph (5)) be placed not further than 20 metres from the junction and so as to be visible to such traffic, on each side of the carriageway by which traffic may pass from the relevant road into the other road.

(5) Paragraph (4) does not apply if—

- (a) the maximum speed limit in force on the other road is greater than that in force on the relevant road; and

*Status: This is the original version (as it was originally made). This item of legislation is currently only available in its original format.*

- (b) signs indicating the maximum speed limit have been placed on the other road in accordance with direction 11 on each side of, and not more than 100 metres from, the junction.

**The placing of certain signs to indicate the end of a restriction, requirement, prohibition or speed limit**

**10.**—(1) When the sign shown in diagram 618.4, 622.2, 645, 647, 664, 666, 667.2, 668.2, 673, 675 or 964 is placed to indicate the point at which traffic on a road ceases to be subject to a restriction, requirement, prohibition or speed limit, the sign shall be placed on the road as near as practicable to that point.

(2) Subject to paragraph (3), where a length of road ceases to be subject to a speed limit and becomes subject to a national speed limit, the sign shown in diagram 671 shall be placed at or as near as practicable to the point where the speed limit ends and the national speed limit begins.

(3) Where a temporary restriction of speed has been imposed under section 14 of the 1984 Act along a length of road by reason of works which are being or are proposed to be executed on or near that road, there shall be placed at or as near as practicable to the point where the temporary restriction of speed ends—

- (a) the sign shown in diagram 7006 or in diagram 7001 (placed in combination with the plate shown in diagram 645); and
- (b) in a case where, but for the temporary speed limit, a change in speed limit would at some point have occurred along the length of road, the sign shown in diagram 670 (varied as appropriate) or 671.

(4) When the sign shown in diagram 671, 673 or 675 is placed to indicate the point at which traffic on a road ceases to be subject to a speed limit—

- (a) where the road has only one carriageway, one such sign shall be placed on each side of the carriageway of the road; or
- (b) where the road has more than one carriageway, one such sign shall be placed on each side of each carriageway on which the speed limit ends.

(5) Where a road (“the relevant road”) has a junction with the side of another road (“the other road”) and—

- (a) a maximum speed limit is in force on the other road; and
- (b) a national speed limit is in force on the relevant road,

then, for the purpose of indicating the national speed limit to traffic entering the relevant road from the other road, the sign shown in diagram 671 or 675 shall be placed on the relevant road in accordance with paragraph (6).

(6) The sign shall be placed not more than 20 metres from the junction with the other road on the left hand or near side of the relevant road as viewed in the direction of travel of a vehicle entering the relevant road from the other road or, if the relevant road is a dual carriageway road, on the left hand or near side of the carriageway by which a vehicle may pass into the relevant road from the other road.

(7) Where the relevant road has a junction with the side of the other road and—

- (a) a national speed limit is in force on the other road; and
- (b) a maximum speed limit is in force on the relevant road,

then, for the purpose of indicating the national speed limit to traffic entering the other road from the relevant road, traffic signs shown in diagram 671 or 675 shall be placed in accordance with paragraph (8) on the relevant road not further than 20 metres from the junction.

(8) If the relevant road has one carriageway, one such sign shall be placed on each side of that carriageway and, if the relevant road is a dual carriageway road, one such sign shall be placed on each side of the carriageway by which traffic may pass from the relevant road into the other road.

### **Repeater signs**

**11.**—(1) Paragraph (2) applies to the signs shown in diagrams 614, 632, 636, 636.1, 636.2, 637.1, 637.2, 637.3, 638, 638.1 when the arrow is omitted, 639 when the arrow is omitted, 639.1B, 640 when the arrow is omitted, 642, 646, 650.1, 650.2, 650.3, 660, 660.3, 660.4, 660.5, 660.6, 661A, 661.1, 662, 670 (except when displayed on a variable message sign in the manner mentioned in regulation 58(7)(b)), 672, 956, 957, 959, 959.1, 960, 960.1 and 961.

(2) Subject to paragraphs (3) and (4), signs to which this paragraph applies shall be placed at regular intervals along a road which is subject to a restriction, requirement, prohibition or speed limit which can be indicated by the signs.

(3) Signs shown in diagram 670 when varied to “20” need not be placed in accordance with paragraph (2) on a road within an area into which each entrance for vehicular traffic has been indicated by the sign shown in diagram 674.

(4) The sign shown in diagram 670 (except when displayed on a variable message sign in the manner mentioned in regulation 58(7)(b)) shall not be placed along—

- (a) a road on which there is provided a system of carriageway lighting furnished by lamps lit by electricity placed not more than 183 metres apart in England and Wales or not more than 185 metres apart in Scotland and which is subject to a speed limit of 30 mph; or
- (b) a motorway on which a national speed limit is in force.

(5) The sign shown in diagram 671 shall be placed at regular intervals along the length of a road (other than a motorway) on which—

- (a) there is a system of street or carriageway lighting furnished by lamps lit by electricity placed not more than 183 metres apart in England and Wales or not more than 185 metres apart in Scotland; and
- (b) a national speed limit is in force.

### **Signs to be placed only on specified types of road**

**12.**—(1) The signs shown in diagrams 2001, 2002, 2003, 2004, 2005, 2005.1, 2006, 2007, 2008, 2009, 2010.1, 2010.2, 2011, 2012, 2013, 2014, 2015, 2016, 2017, 2018, 2019, 2020, 2021, 2021.1, 2022, 2023, 2024, 2025, 2030, 2030.1, 2032, 2033, 2034, 2035 and 2717 may be placed only on or near a primary route.

(2) The signs shown in diagrams 2026, 2027, 2027.1, 2028 and 2029 may be placed only on a primary route, or on a non-primary route at a junction with a primary route.

**13.**—(1) The signs shown in diagrams 2101, 2101.1, 2101.2, 2102, 2102.1, 2103, 2104, 2105.1, 2106.1, 2107, 2108, 2109, 2110, 2111, 2111.1, 2112, 2113, 2113.1, 2114, 2114.1, 2115, 2115.1, 2116, 2117, 2118, 2119, 2120, 2121, 2122, 2123, 2124, 2124.1, 2128, 2129, 2130, 2131, 2133, 2135, 2137.1, 2138 and 2139 may be placed only on or near a non-primary route.

(2) The signs shown in diagrams 2125, 2126, 2126.1, 2127, 2132, 2134, 2136, 2137, 2140, 2322 and 2323 may be placed only on or near a non-primary route, or on a primary route at a junction with a non-primary route.

(3) The signs shown in diagrams 1012.3, 2031, 2201, 2202, 2203, 2204, 2205, 2208, 2209, 2210, 2211, 2212, 2213, 2214, 2215, 2216, 2217, 2218, 2301, 2302, 2303, 2304, 2305, 2306, 2307, 2308.1, 2309.1, 2310.1, 2311.1, 2311.2, 2313.1, 2313.2, 2313.3, 2313.4, 2313.5, 2313.6, 2314.1, 2314.2,

*Status: This is the original version (as it was originally made). This item of legislation is currently only available in its original format.*

2324, 2325, 2326, 2327, 2328, 2329, 2330, 2401, 2402.1, 2403.1, 2501, 2502, 2504, 2505, 2505.1, 2506, 2507, 2508, 2509.1, 2510, 2511, 2512, 2513, 2601.1, 2601.2, 2602.1, 2602.2, 2602.3, 2603, 2604, 2605, 2606, 2607, 2608, 2609, 2610, 2610.1, 2610.2, 2701, 2701.1, 2702, 2703, 2704, 2705, 2706, 2707, 2708, 2709, 2710, 2712, 2713.1, 2801, 2802, 2803, 2804, 2805, 2806, 2806.1, 7031, 7242 and 7285 may not be placed on a motorway.

(4) The sign shown in diagram 2141 may only be placed on or near a minor route at a junction with another minor route and, for this purpose, “minor route” means any road except a road to which the Secretary of State, the Scottish Ministers or the National Assembly for Wales has assigned a number prefixed by the letter A, B or M.

**14.**—(1) The signs shown in diagrams 832.3, 1012.2, 1064, 2901, 2903, 2904, 2904.1, 2905, 2906, 2908, 2908.1, 2909, 2910, 2910.1, 2911, 2912, 2913, 2913.1, 2913.2, 2913.3, 2913.4, 2914, 2914.1, 2915, 2917, 2918, 2918.1, 2919.1, 2920.1, 2921, 2921.1, 2922, 2924, 2925, 2926, 2927, 2927.1, 2928, 2929, 2929.1, 2930, 2931, 2932, 2933, 2934, 7241 and 7286 may be placed only on or near a motorway.

(2) The signs shown in diagrams 2902 and 2902.1 may be placed only on a motorway or on another road at a junction with a motorway.

**15.**—(1) The signs shown in diagrams 823, 824, 825, 868, 868.1, 872.1, 873, 874, 875, 876 and 2713 may be placed only on or near—

- (a) a motorway when the colour of the background of the sign is blue;
- (b) a primary route when the colour of the background of the sign is green; or
- (c) a non-primary route when the colour of the background of the sign is white.

(2) The sign shown in diagram 872.1 may only be placed on a dual carriageway road or a one-way road.

(3) The sign shown in diagram 877 may be placed only on or near—

- (a) a motorway exit slip road when the colour of the background of the sign is blue;
- (b) a primary route when the colour of the background of the sign is green; or
- (c) a non-primary route when the colour of the background of the sign is white.

### **Speed limits of 20 mph**

**16.**—(1) The sign shown in diagram 674 may only be placed on a road if no point on any road (not being a cul-de-sac less than 80 metres long), to which the speed limit indicated by the sign applies, is situated more than 50 metres from a traffic calming feature.

(2) In paragraph (1) “traffic calming feature” means—

- (a) a road hump constructed pursuant to section 90A of the Highways Act 1980<sup>(48)</sup> (“the 1980 Act”) or section 36 of the Roads (Scotland) Act 1984<sup>(49)</sup> (“the 1984 Act”) and in accordance with the Highways (Road Humps) Regulations 1999<sup>(50)</sup> or the Road Humps (Scotland) Regulations 1998<sup>(51)</sup>;
- (b) traffic calming works constructed in accordance with section 90G of the 1980 Act<sup>(52)</sup> or section 39A of the 1984 Act<sup>(53)</sup> and in accordance with the Highways (Traffic Calming) Regulations 1999<sup>(54)</sup> or the Roads (Traffic Calming) (Scotland) Regulations 1994<sup>(55)</sup>;

<sup>(48)</sup> 1980 c. 66; section 90A was inserted by the Transport Act 1981 (c. 56), section 32(1), Schedule 10 Part I, paragraph 2.

<sup>(49)</sup> 1984 c. 54; section 36 was amended by the Road Traffic Act 1991, Schedule 4, paragraph 38.

<sup>(50)</sup> S.I. 1999/1025.

<sup>(51)</sup> S.I. 1998/1448; relevant amending instrument is S.I. 1999/1000.

<sup>(52)</sup> Section 90G was inserted by the Traffic Calming Act 1992 (c. 30), Schedule 1.

<sup>(53)</sup> Section 39A was inserted by the Traffic Calming Act 1992, Schedule 2.

**Status:** This is the original version (as it was originally made). This item of legislation is currently only available in its original format.

- (c) a refuge for pedestrians which was constructed pursuant to section 68 of the 1980 Act or section 27(c) of the 1984 Act after 15th June 1999 and is so constructed as to encourage a reduction in the speed of traffic using the carriageway;
- (d) a variation of the relative widths of the carriageway or of any footway pursuant to section 75 of the 1980 Act or section 1(1) or 2(1) of the 1984 Act which—
  - (i) was carried out after 15th June 1999 for the purpose of encouraging a reduction in the speed of traffic using the carriageway; and
  - (ii) had the effect of reducing the width of the carriageway; or
- (e) a horizontal bend in the carriageway through which all vehicular traffic has to change direction by no less than 70 degrees within a distance of 32 metres as measured at the inner kerb radius.

(3) For the purposes of paragraph (1) the distance of 50 metres shall be measured along roads to which the speed limit indicated by the sign shown in diagram 674 applies.

**Signs to be placed only in conjunction with specified road markings (except signs for prohibitions and restrictions on waiting etc)**

17.—(1) Save as provided in paragraph (2), a sign shown in a diagram whose number appears and is placed in the circumstances (if any) or is in the form (if any) specified in column (2) of an item in the Table may be placed on a road only—

- (a) in conjunction with the road marking shown in the diagram whose number appears and is in the form (if any) specified in column (3) of that item; or
- (b) where the numbers of two or more road markings so appear, in conjunction with both or all of those markings.

**Table**

<i>(1)</i> <i>Item</i>	<i>(2)</i> <i>Sign diagram number</i>	<i>(3)</i> <i>Road marking diagram number</i>
1.	508.1, 509.1	1010
2.	557.1	1062
3.	601.1	1002.1 and 1022
4.	602	1003 and 1023
5.	611.1 if placed in conjunction with diagram 602	1003, 1003.4 and 1023
6.	611.1	1003.3 and 1003.4
7.	957	1057
8.	958	1010
9.	958.1	1009
10.	959	1048 and 1049

(54) S.I. 1999/1026.

(55) S.I. 1994/2488; relevant amending instrument is S.I. 1999/1000.

**Status:** This is the original version (as it was originally made). This item of legislation is currently only available in its original format.

<i>(1)</i> <i>Item</i>	<i>(2)</i> <i>Sign diagram number</i>	<i>(3)</i> <i>Road marking diagram number</i>
11.	959.1	1049 varied to a width of 150 millimetres and 1057
12.	960	1048 and 1049
13.	960 varied to include pedal cycle symbol	1048.1 and 1049
14.	960.1	1049 varied to a width of 150 millimetres and 1057
15.	2933	1064
16.	2934	1064

(2) The provisions of paragraph (1) requiring the placing of the sign shown in diagram 601.1, 602 or 611.1 in conjunction with a road marking shall not apply during the execution of works on a road near the sign—

- (a) if those works necessitate the temporary removal of the marking; or
- (b) if the sign is placed only temporarily in connection with the execution of works on a road.

**Road markings to be placed only in conjunction with other road markings or specified signs (except road markings for prohibitions and restrictions on waiting etc)**

**18.**—(1) A road marking shown in a diagram whose number appears and is placed in the circumstances (if any) specified in column (2) of an item in Table 1 may be placed on a road only in conjunction with a road marking or sign shown in a diagram whose number appears and is in the form, or is placed in the manner or circumstances (if any), specified in column (3) of that item.

**Table 1**

<i>(1)</i> <i>Item</i>	<i>(2)</i> <i>Road marking diagram number</i>	<i>(3)</i> <i>Road marking or sign diagram number</i>
1.	1001, except when placed at a site where traffic is from time to time controlled by a constable in uniform or traffic warden	3000, 3000.1, 3000.2, 3000.7, 3000.8, 3000.9, 3000.10 or 3014
2.	1001.1	3013
3.	1001.2	3000, 3000.7, 3000.8, 3000.9 or 3000.10 placed adjacent to the stop line appearing above the pedal cycle symbol in diagram 1001.2
4.	1001.3	1001 together with— (a) 1055.1 or 1055.2; and (b) 4002.1, 4003.1, 4003.2, 4003.4, 4003.5 or 4003.7
5.	1003.4	611.1
6.	1023	1003 or 1003.3



**Status:** This is the original version (as it was originally made). This item of legislation is currently only available in its original format.

<i>(1)</i> <i>Item</i>	<i>(2)</i> <i>Road marking diagram number</i>	<i>(3)</i> <i>Road marking or sign diagram number</i>
7.	1045	1013.1 (version A)
8.	1048.2 without any variation	953.1 varied to include the bus symbol shown in diagram 953 or the local bus symbol in diagram 958
9.	1048.2 varied to omit “& BUS”	953.1 as not varied
10.	1048.4	953
11.	1057	955, 956, 957, 959.1, 960.1, 965, 967, 1001.2 when used in conjunction with 1004 or 1004.1, 2601.2 or 2602.2
12.	1058	1057
13.	1059	1057
14.	1062 except when placed in a zone indicated by the sign shown in diagram 674	557.1, 543 and 547.8, or 544 and 547.8
15.	1062 except when placed at a signal-controlled crossing facility or at a “crossing” as defined by section 25(6) of the 1984 Act, or to indicate a road hump which extends across the carriageway for less than 5 metres	1004
16.	1062 when placed to indicate a road hump with tapered ends which does not extend across the whole width of the carriageway but ends within 300 millimetres of the kerb-line	1012.1, 1017 or 1018.1
17.	1064	2933 and 2934
18.	1065	670, when placed to indicate the point at which a speed limit begins or as a repeater sign in accordance with direction 11(2), or 674

(2) The road marking shown in diagram 1001.2 may be placed only at a junction where traffic is regulated by light signals of the kind prescribed by regulation 33(1).

(3) A road marking shown in a diagram whose number appears in column (2) of an item in Table 2 may be placed on a road only in conjunction with the combination of road markings or signs specified in column (3) of that item.

**Status:** This is the original version (as it was originally made). This item of legislation is currently only available in its original format.

**Table 2**

<i>(1)</i> Item	<i>(2)</i> Road marking diagram number	<i>(3)</i> Diagram numbers of road markings or signs in combination
1.	1002.1	601.1 and 1022
2.	1003 when used at a level crossing	602 and 1023
3.	1003.3 except when placed at a roundabout with a small central island	611.1 and 1003.4
4.	1022	601.1 and 1002.1
5.	1024.1	1010 and 1014
6.	1048	1049 and either 959 or 960
7.	1048.1	1049 and 960 varied to include the pedal cycle symbol
8.	1049 except when varied to a width of 150 millimetres	(a) (a) 1048 and either 959 or 960; or (b) 1048.1 and 960 varied to include the pedal cycle symbol
9.	1049 when varied to a width of 150 millimetres	(a) (a) 957 and 1057; (b) 959.1 and 1057; or (c) 960.1 and 1057
10.	1049.1	957 and 1057
11.	1050	964 and 1049

(4) The road marking shown in diagram 1048.3 may be placed on a road if and only if it is placed in conjunction with either—

- (a) a combination of the sign shown in diagram 616 and the sign shown in diagram 954 or 954.2; or
- (b) the sign shown in diagram 953 varied to show only the bus symbol.

(5) A road marking shown in diagram 1003 or 1023 when varied in size to conform with any of the smaller dimensions prescribed for it may be placed on a road only in conjunction with the marking shown in diagram 1057 and with one or more of the signs shown in diagrams 955, 956 and 957, or where a contra-flow cycle lane ends at a junction with another road.

(6) The road marking shown in diagram 1009 when varied in size to conform with the smallest dimensions prescribed for it may be placed on a road only to mark the junction of a cycle track and another road and in conjunction with the road markings shown in diagrams 1003 and 1023 and having the smaller dimensions prescribed for them.

(7) The road marking shown in diagram 1064 may be placed on the carriageway of a road if and only if—

- (a) it is placed as one of a series of such markings placed 40 metres apart;
- (b) the carriageway on which a marking is placed has more than one traffic lane and such a series is placed in each lane;

**Status:** This is the original version (as it was originally made). This item of legislation is currently only available in its original format.

- (c) each series includes the same number of markings; and
- (d) a straight line drawn across the carriageway at right angles to the direction of travel and passing through a marking would pass through a marking on each of the other traffic lanes of the carriageway.

**The placing of the signs shown in diagrams 615 and 811**

19. The signs shown in diagrams 615 and 811 may be placed on a road only in conjunction with one another.

**Signs to be placed only in combination with specified plates or other signs**

20.—(1) A sign shown in a diagram whose number appears and is placed in the circumstances (if any) specified in column (2) of an item in the Table may be placed on a road only in combination with a plate shown in the diagram whose number appears in column (3) of that item.

**Table**

<i>(1)</i> <i>Item</i>	<i>(2)</i> <i>Sign diagram number</i>	<i>(3)</i> <i>Plate diagram number</i>
1.	501 when placed in advance of the sign shown in diagram 601.1	502
2.	501 when placed in advance of the sign shown in diagram 602	503
3.	553.1	553.2
4.	554.2	554.3
5.	556.1	556.2
6.	557.1	557.2, 557.3 or 557.4
7.	562	563, 563.1 or 7022
8.	583	583.1
9.	584	584.1
10.	601.1 when placed at a level crossing	783
11.	615	615.1 or 645
12.	617	618 or 618.1
13.	622.8	622.9
14.	779	780A, 780.1A or 780.2A
15.	811	645 or 811.1
16.	953	953.2
17.	953.1	953.2

- (2) The sign shown in diagram 545 may be placed on a road only if it is used either—
  - (a) in combination with the plate shown in diagram 546, 547.1, 547.2, 547.3 or 547.7; or

*Status: This is the original version (as it was originally made). This item of legislation is currently only available in its original format.*

(b) in combination with the plate shown in diagram 546, 547.1 or 547.7 and with the light signals shown in diagram 4004.

(3) The sign shown in diagram 515 (when placed on the central island of a roundabout), 515.1A or 515.2 may be placed on a road only in combination with the sign shown in diagram 606.

**Plates to be placed only in combination with specified signs**

**21.**—(1) A plate shown in a diagram whose number appears and is in the form (if any) specified in an item in column (2) of the Table may be placed on a road only in combination with a sign shown in a diagram whose number appears and is placed in the circumstances (if any) specified in column (3) of that item.

**Table**

<i>(1)</i> <i>Item</i>	<i>(2)</i> <i>Plate diagram number</i>	<i>(3)</i> <i>Sign diagram number</i>
1.	502	501
2.	503	501
3.	511	504.1, 505.1, 506.1, 507.1, 510, 512, 512.1, 512.2, 513, 516, 517, 520, 523.1, 524.1, 528 or 556
4.	511 when varied to “HEAVY PLANT CROSSING”	504.1, 505.1, 506.1, 507.1, 512.1 or 512.2
5.	513.1	510, 512, 512.1, 512.2 or 513
6.	513.2	512, 512.1, 512.2, 513 or 7009
7.	518	516, 517 or 520
8.	519	516 or 517
9.	525	523.1 or 524.1
10.	526	512, 512.1, 512.2, 513, 523.1, 524.1 or 554.1
11.	527	523.1 or 524.1
12.	530.1	530
13.	530.2	530, 629.2 or 629.2A
14.	531.2	531.1
15.	543.1	543, 3000, 3000.7, 3000.8, 3000.9 or 3000.10
16.	546	545
17.	547.1	545
18.	547.2	545
19.	547.3	544.1 or 545
20.	547.4	544.2
21.	547.7	545

**Status:** This is the original version (as it was originally made). This item of legislation is currently only available in its original format.

<i>(1)</i> <i>Item</i>	<i>(2)</i> <i>Plate diagram number</i>	<i>(3)</i> <i>Sign diagram number</i>
22.	547.8	543 or 544
23.	548.1	548 when placed in advance of the sign shown in diagram 4005
24.	553	552
25.	553.2	553.1
26.	554.3	554.2, 622.1A, 622.4, 629, 629A, 629.1 or 632
27.	556.2	556.1
28.	557.2	557.1
29.	557.3	557.1
30.	557.4	557.1
31.	558.2	558
32.	563	562
33.	563 when varied to "Road liable to flooding"	554 or 562
34.	563.1	562
35.	570	513, 521, 523.1, 524.1, 548, 549, 550, 550.1, 550.2, 551, 551.1, 551.2, 554 (when varied to "Gates"), 555.1, 556, 557, 558, 558.1, 559, 581, 582, 614, 632, 642, 7001 or 7009
36.	572	504.1, 505.1, 506.1, 507.1, 508.1, 509.1, 510, 516, 517, 520, 521, 522, 523.1, 524.1, 528, 529, 529.1, 530, 531.1, 543, 544, 544.1, 544.2, 550.1, 552, 554, 555, 770, 771, 772, 782, 950, 7001 or 7009
37.	573	523.1, 524.1, 528, 529, 529.1, 530, 531.1, 543, 544, 544.1, 544.2, 550.1, 552, 554, 555, 770, 771, 772, 782, 950, 7001 or 7009
38.	575	512, 512.1, 512.2, 513, 516, 517, 528 or 529.1
39.	583.1	583
40.	584.1	584
41.	607	606 or 609
42.	608	501, 601.1, 602, 606, 609 or 610
43.	615.1	615

**Status:** This is the original version (as it was originally made). This item of legislation is currently only available in its original format.

<i>(1)</i> <i>Item</i>	<i>(2)</i> <i>Plate diagram number</i>	<i>(3)</i> <i>Sign diagram number</i>
44.	618	617
45.	618.1	617
46.	620	619, 619.1, 619.2, 622.1A, 622.5, 622.6, 622.7, 622.8, 629, 629A, 629.1 or 952
47.	620.1	619 or 619.1
48.	622.9	622.8
49.	627.1	626.2A
50.	645	614, 615, 632, 642, 811 or 7001
51.	773	529, 529.1, 558, 770, 771 or 772
52.	778	602
53.	778.1	602
54.	780A	779
55.	780.1A	779
56.	780.2A	779
57.	804.1	801
58.	804.2	801
59.	804.3	801
60.	804.4	801
61.	811.1	811
62.	817.2	523.1 and either 525 or 526, or 554.1 and 526
63.	876	868, 868.1, 872.1, 873, 874 or 875
64.	950.1	950
65.	953.2	953 or 953.1
66.	954	606, 609, 612, 613, 616, 629, 629A or 629.1
67.	954.2	606, 609, 612, 613, 616, 629, 629A, 629.1 or 952
68.	954.3	606, 609, 612 or 613
69.	954.4	606, 609, 612, 613 or 816
70.	954.5	606, 612, 613
71.	954.6	606, 612, 613
72.	954.7	606, 612, 613
73.	961	958, 958.1, 959 or 959.1

**Status:** This is the original version (as it was originally made). This item of legislation is currently only available in its original format.

<i>(1)</i> <i>Item</i>	<i>(2)</i> <i>Plate diagram number</i>	<i>(3)</i> <i>Sign diagram number</i>
74.	2602.3	955, 956 or 957
75.	7001.1	7001
76.	7001.2	7001
77.	7021	7001
78.	7022	562
79.	7030	543
80.	7208	7202, 7206 or 7207
81.	7209	7203, 7203.1, 7204 or 7205
82.	7256	7250, 7251, 7252, 7253, 7254 or 7255

(2) A plate shown in diagram 954.3 or 954.4 or the sign shown in diagram 954.6 or 954.7 shall not be placed in combination with the sign shown in diagram 616.

### **Placing of road markings and signs to indicate prohibitions and restrictions on waiting, loading and unloading and parking**

22.—(1) Subject to paragraphs (2) and (3)—

- (a) the road marking shown in diagram 1018.1 may be placed on a side of a road only for the purpose of indicating a statutory prohibition or restriction on the waiting of vehicles which applies on that side of the road at all times of day on every day of the year or on every day in a period of at least four consecutive months; and
- (b) the road marking shown in diagram 1017 may be placed on a side of a road only for the purpose of indicating a statutory prohibition or restriction on the waiting of vehicles which is not a restriction of the kind mentioned in sub-paragraph (a).

(2) In this direction, references to a statutory prohibition or restriction on the waiting of a vehicle do not include references to any such prohibition or restriction imposed—

- (a) on waiting for the purpose of loading or unloading goods from a vehicle or picking up or setting down passengers from a vehicle;
- (b) and expressly to limit the duration of waiting of vehicles within a particular period; or
- (c) on the waiting of goods vehicles (as defined by section 192(1) of the Road Traffic Act 1988<sup>(56)</sup>) but of no other class of vehicle.

(3) The road marking shown in diagram 1017 or 1018.1 shall not be placed on a road on which is placed—

- (a) the marking shown in diagram 1025.1, 1025.3, 1025.4 or 1028.2 (in conjunction with the sign shown in diagram 650.1); or
- (b) the marking shown in diagram 1027.1 in conjunction with the sign shown in diagram 642.2A, unless there are times at which the restrictions to be indicated by the marking shown in diagram 1017 or 1018.1 apply and those indicated by that sign do not.

<sup>(56)</sup> 1988 c. 52.

*Status: This is the original version (as it was originally made). This item of legislation is currently only available in its original format.*

**23.**—(1) The road marking shown in diagram 1020.1 may be placed on a side of the carriageway of a road only for the purpose of indicating a statutory prohibition or restriction on the waiting of vehicles for the purpose of their being loaded or unloaded which applies on that side of the road at all times of the day on every day of the year or on every day in a period of at least four consecutive months.

(2) The road marking shown in diagram 1019 may be placed on a side of the carriageway of a road only for the purpose of indicating a statutory prohibition or restriction on the waiting of vehicles for the purpose of their being loaded or unloaded (but not for indicating a statutory prohibition or restriction which expressly limits the duration of waiting by vehicles within a particular period for that purpose) which is not a restriction of the kind mentioned in paragraph (1).

**24.**—(1) Except where it is placed to indicate the effect of a temporary statutory provision and subject to paragraph (2), a sign shown in a diagram specified in column (2) of an item in the Table shall not be placed except—

- (a) on or near the side of a road; and
- (b) in conjunction with, and on the same side of the road as, a road marking which is shown in a diagram and is in the form (if any) indicated in column (3) of that item.

**Table**

<i>(1)</i> <i>Item</i>	<i>(2)</i> <i>Sign diagram number</i>	<i>(3)</i> <i>Road marking diagram number</i>
1.	637.3	1018.1
2.	638	1020.1
3.	638.1	1019
4.	639	1017
5.	639.1B	1017 and 1028.3, 1028.4, 1032 or 1033
6.	639.1B when the sign shown in diagram 638.1 is added as a middle panel	1017 and 1019, and 1028.3, 1028.4, 1032 or 1033
7.	640	(a) (a) 1017 or 1018.1; and (b) 1019 or (when the lower panel of the sign shown in diagram 640 is varied to “No loading at any time”) 1020.1
8.	640 when the upper panel is varied to the sign shown in diagram 650.3	(a) 1028.2; (b) 1017 or 1018.1; and (c) 1019 or (when the lower panel of the sign shown in diagram 640 is varied



**Status:** This is the original version (as it was originally made). This item of legislation is currently only available in its original format.

<i>(1)</i> <i>Item</i>	<i>(2)</i> <i>Sign diagram number</i>	<i>(3)</i> <i>Road marking diagram number</i>
		to “No loading at any time”) 1020.1
9.	642.2A	1027.1
10.	642.3	1018.1
11.	650.1	1028.2 when varied to include a continuous yellow line 200 or 300mm wide in the manner shown in diagram 1025.1
12.	650.2	1028.2
13.	650.3	1028.2, and 1017 or 1018.1
14.	660	(a) (a) 1028.3 (when varied to indicate “LARGE OR SLOW VEHICLES ONLY”); (b) 1028.4, 1032 or 1033 in each case when indicating “DOCTOR” or when no legend appears; or (c) 1028.4 when varied to indicate “PERMIT HOLDERS ONLY”
15.	660.3	(a) (a) 1028.4, 1032 or 1033, in each case when indicating “DOCTOR” or when no legend appears; or (b) 1028.4 when varied to indicate “PERMIT HOLDERS ONLY”
16.	660.4	(a) (a) 1028.3 or 1032 in each case when varied to indicate “LOADING ONLY”; or (b) 1033 when no legend appears
17.	660.5	1028.4, 1032 or 1033, in each case when no legend appears

**Status:** This is the original version (as it was originally made). This item of legislation is currently only available in its original format.

<i>(1)</i> <i>Item</i>	<i>(2)</i> <i>Sign diagram number</i>	<i>(3)</i> <i>Road marking diagram number</i>
18.	660.6	1028.4, 1032 or 1033 in each case when no legend appears
19.	660.7	1028.4, 1032 or 1033, in each case when no legend appears
20.	661A	1028.3, 1032 or 1033 in each case when varied to indicate “DISABLED” or when no legend appears
21.	661.1	1028.3 (when varied to “BUSES”), 1028.4 (when varied to “SOLO MOTORCYCLES ONLY”, “SOLO M/CYCLES ONLY” or “SOLO M/CS ONLY” or when no legend appears), 1032 (when no legend appears) or 1033 (when no legend appears)
22.	661.2A	1028.4, 1032 or 1033, in each case when no legend appears
23.	661.3A	1028.4, 1032 or 1033, in each case when no legend appears
24.	662	1028.4, 1032 or 1033, in each case when no legend appears
25.	974	1025.1, 1025.3 or 1025.4, in each case when indicating “BUS STOP”
26.	975	1025.1, 1025.3 or 1025.4, in each case when varied to “BUS STAND”

(2) Paragraph (1) shall not apply to the signs shown in diagrams 637.3, 639 and 640 when placed to indicate restrictions applying to the same road as restrictions indicated by the sign shown in diagram 650.1, 974 or 975.

(3) Subject to paragraph (4) the sign shown in diagram 637.2 may be placed only on a road within a pedestrian zone where the sign shown in diagram 618.3 or 618.3A is placed at each entrance into the zone for vehicular traffic.

(4) The sign shown in diagram 637.2 shall not be used on a road within the pedestrian zone to which the sign relates except in conjunction with—

(a) the road marking shown in diagram 1017 or 1018.1 unless—

- (i) the road does not comprise a carriageway and footway which are separately defined;
- (ii) the entry of vehicular traffic into the pedestrian zone is restricted at the same times as those at which the waiting of vehicles is prohibited as indicated on the upper panel of the sign in diagram 637.2; and

**Status:** This is the original version (as it was originally made). This item of legislation is currently only available in its original format.

- (iii) the prohibition on the waiting of vehicles applies uniformly throughout every road in the zone, and
- (b) where there is a prohibition on the loading and unloading of vehicles, the road marking shown in diagram 1019 or 1020.1 unless—
  - (i) the road does not comprise a carriageway and footway which are separately defined;
  - (ii) the entry of vehicular traffic into the pedestrian zone is restricted at the same times as those at which the loading and unloading of vehicles is prohibited as indicated on the lower panel of the sign in diagram 637.2; and
  - (iii) the prohibition on the loading and unloading of vehicles applies uniformly throughout every road in the zone.

**25.**—(1) Subject to paragraph (2) a road marking shown in a diagram whose number appears and is in the form (if any) specified in an item in column (2) of the Table may be placed on a road only in conjunction with, and on the same side of the road as, a sign shown in a diagram whose number appears and in the form specified (if any) in column (3) of that item.

**Table**

<i>(1)</i> <i>Item</i>	<i>(2)</i> <i>Road marking diagram number</i>	<i>(3)</i> <i>Sign diagram number</i>
1.	1017	637.2, 639, 639.1B, 640 or 650.3
2.	1019	637.2, 638.1, 639.1B (when the sign shown in diagram 638.1 is added as a middle panel) or 640
3.	1020.1	637.2, 638 or 640 (when the lower panel is varied to “No loading at any time”)
4.	1025.1	974 or 975
5.	1025.3	974 or 975
6.	1025.4	974 or 975
7.	1028.2	640 (when the upper panel is varied to the sign shown in diagram 650.3), 650.1, 650.2 or 650.3
8.	1028.3 when indicating “DISABLED”	661A or 639.1B (when the lower panel is varied to the sign shown in diagram 661A)
9.	1028.3 when varied to “BUSES”	661.1 (when varied to include the bus symbol), 639.1B (when the lower panel is so varied) or 969
10.	1028.3 when varied to “LARGE OR SLOW VEHICLES ONLY”	660 (varied to “Large or slow vehicles only”) or 639.1B (when the lower panel is so varied)
11.	1028.3 when no legend appears	661A, 639.1B (when the lower panel is varied to show the sign

*Status: This is the original version (as it was originally made). This item of legislation is currently only available in its original format.*

<i>(1)</i> <i>Item</i>	<i>(2)</i> <i>Road marking diagram number</i>	<i>(3)</i> <i>Sign diagram number</i>
		shown in diagram 661A), 786 or 801 in combination with 804.1
12.	1028.3 when varied to “LOADING ONLY”	660.4 or 639.1B (when the lower panel is varied to the sign shown in diagram 660.4)
13.	1028.4 when indicating “DOCTOR”	660 varied to “Doctor permit holders only” or 639.1B (when the lower panel is so varied)
14.	1028.4 when varied to “PERMIT HOLDERS ONLY”	(a) (a) 639.1B when the lower panel is varied to the sign shown in diagram 660 (except the variants “Card holders only” and “Large or slow vehicles only”) or 660.3; (b) 660 (except when varied to “Card holders only” or “Large or slow vehicles only”); or (c) 660.3
15.	1028.4 when no legend appears	639.1B, 660, 660.3, 660.5, 660.6, 660.7, 661.1, 661.2A, 661.3A, 662, 667, 667.1, 668, 668.1, or 801
16.	1032 when indicating “DOCTOR”	660 varied to “Doctor permit holders only” or 639.1B (when the lower panel is so varied)
17.	1032 when indicating “DISABLED”	661A or 639.1B (when the lower panel is varied to the sign shown in diagram 661A)
18.	1032 when indicating “LOADING ONLY”	660.4 or 639.1B (when the lower panel is varied to the sign shown in diagram 660.4)
19.	1033 when indicating “DISABLED”	661A or 639.1B (when the lower panel is varied to the sign shown in diagram 661A)
20.	1033 when indicating “DOCTOR”	660 varied to “Doctor permit holders only” or 639.1B (when the lower panel is so varied)

(2) Paragraph (1) shall not apply to a road marking placed on a road within a controlled parking zone, if signs shown in diagram 663 or 663.1 have been placed at the entrances for vehicular traffic into the zone, except where the road marking is placed to indicate restrictions different from the restrictions indicated on those signs.

**26.** The sign shown in diagram 663, 663.1, 664, 665 or 666 may be placed only at the boundary of a controlled parking zone.

### **Signs to be placed only at specified sites or for specified purposes**

**27.** The sign shown in diagram 545, when placed in combination with—

- (a) the plate shown in diagram 547.1; or
- (b) the plate shown in diagram 546, 547.1 or 547.7 together with the light signal shown in diagram 4004,

may be placed only at or near a school crossing place.

**28.** The sign shown in diagram 551.1 may be placed on or near a road only—

- (a) at a site which is approved as a migratory toad crossing by or on behalf of the Secretary of State; and
- (b) during February, March, April and May in each year.

**29.** The sign shown in diagram 574 may be placed only in or near an infected place or area for the purposes of the Animal Health Act 1981<sup>(57)</sup> and shall be removed as soon as it ceases to be in or near such a place or area.

**30.** The sign shown in diagram 601.1 may be placed on or near a road at a junction with another road only if a sign has not been placed on the other road so as to control traffic passing through the junction on that other road.

**31.** The sign shown in diagram 833, 834, 835 or 836 may be placed only to regulate the movement of vehicular traffic into and out of premises with more than one access to a road.

**32.—**(1) The sign shown in diagram 878 or 879 may be placed only in an area or along a route where enforcement cameras are from time to time in use.

(2) The sign shown in diagram 880 may be placed only—

- (a) on or near a road on which there is provided a system of carriageway lighting furnished by means of lamps placed not more than 183 metres apart in England and Wales or 185 metres apart in Scotland and which is subject to a speed limit of 30 mph; and
- (b) not more than one kilometre from a site at which an enforcement camera has been installed and is from time to time in use, and

not more than one such sign may be so placed on each approach to that site.

**33.** The sign shown in diagram 957 may be placed on a road only when the road has been divided into a part reserved for the use of pedal cycles only and a part reserved for use by pedestrians only by either or both of the following means—

- (a) the road marking shown in diagram 1049 (when that marking is varied to be 150 millimetres wide) or 1049.1;
- (b) the presence on the road of works such as distinctive colouring of the surface of each part, a kerb or other device.

**34.—**(1) The marking shown in diagram 1003 may be placed on or near a road only in the following cases—

- (a) at a junction with another road on which no marking has been placed to control traffic passing through the junction on that other road;
- (b) at a roundabout in conjunction with the sign shown in diagram 602 and the road marking shown in diagram 1023;
- (c) at a level crossing in the circumstances described in regulation 25(3);

---

(57) 1981 c. 22.

*Status: This is the original version (as it was originally made). This item of legislation is currently only available in its original format.*

(d) in the circumstances described in regulation 25(4), when such a marking has not been placed to control vehicles travelling in the opposite direction.

(2) The marking shown in diagram 1003 may only be placed on the carriageway of a road in circumstances such that regulation 25(6) (transverse lines placed in advance of a cycle track crossing a road) applies, if the length of the road which is crossed by a cycle track consists of a road hump extending across the full width of the carriageway and constructed pursuant to—

- (a) section 90A of the Highways Act 1980(58) and in accordance with the Highways (Road Humps) Regulations 1999(59); or
- (b) section 36 of the Roads (Scotland) Act 1984(60) and in accordance with the Road Humps (Scotland) Regulations 1998(61).

35. The road marking shown in diagram 1043 or 1044 shall not be placed to indicate an area of carriageway on a roundabout unless the entry of traffic into the roundabout is at all times controlled by traffic light signals.

### **Restrictions on the placing of temporary signs**

36. The signs shown in Schedule 12, other than in diagrams 7014, 7019, 7020, 7032 and 7103, may be placed only in connection with the execution of works on or near a road or a temporary obstruction thereon, and any such sign so placed and any other sign shown in a diagram in Schedules 1 to 11 so placed shall not be retained on or near the road after the completion of the works or the removal of the obstruction, as the case may be, unless—

- (a) it is a sign of the type shown in diagram 7009, in which case that sign may be retained on or near a road after the completion of the works for so long as the traffic authority for the road thinks fit; or
- (b) it is a sign of the type shown in diagram 7012 bearing the words “NO GIVE WAY MARKINGS” or “NO STOP MARKINGS”, in which case that sign shall be removed as soon as the road markings have been replaced and in any event not later than 28 days after the completion of the works.

37.—(1) The sign shown in diagram 790 or 7014—

- (a) may be placed only in connection with works involving—
  - (i) an alteration in the layout of the carriageway of a road or level crossing; or
  - (ii) the placing, removal or alteration of traffic signs on or near a road or at a level crossing; and
- (b) may be retained not later than the end of the period of 3 months beginning with completion of those works.

(2) The sign shown in diagram 7032—

- (a) may be placed only to indicate the point at which a recently imposed speed limit of 30 mph begins on a road—
  - (i) on which there is a system of street or carriageway lighting furnished by lamps lit by electricity placed not more than 183 metres apart in England and Wales or not more than 185 metres apart in Scotland; and
  - (ii) which had previously been subject to a higher speed limit;
- (b) shall be placed as near as practicable to that point;

(58) 1980 c. 66; section 90A was inserted by the Transport Act 1981 (c. 56), section 32(1), Schedule 10 Part I, paragraph 2.

(59) S.I. 1999/1025.

(60) 1984 c. 54; section 36 was amended by the Road Traffic Act 1991, Schedule 4, paragraph 38.

(61) S.I. 1998/1448; relevant amending instrument is S.I. 1999/1000.

- (c) shall not be placed unless that point could not otherwise be indicated in accordance with these Directions;
- (d) may be placed only during the period of 6 months beginning with the day on which the 30 mph speed limit comes into force; and
- (e) shall not be retained after the end of that period.

**38.**—(1) No sign of the kind referred to in regulation 53 may be retained at any place for more than 6 months (or in the case of a sign of the kind referred to in regulation 53(1)(d) for more than 2 years) or such longer period as the Secretary of State may approve after the placing of the sign there or in any event after the sign has ceased to be needed at that place.

(2) The sign shown in diagram 2701 or 2701.1 may be retained on or near a road for not more than six months after completion of the housing development to which it refers.

**39.**—(1) The sign shown in diagram 7023 or 7024 may be placed on or near a road only where—

- (a) one-way working is necessary along a length of road because part of the width of the carriageway has been temporarily closed to traffic; and
- (b) either—
  - (i) there is no junction with another road along that length; or
  - (ii) the traffic authority has given express written approval to the placing of the sign in relation to a length of road having a junction with another road.

(2) The sign shown in diagram 543 may be placed in combination with the plate shown in diagram 7030 only on or near a road on which convoy working is in operation and indicated by one or more of the signs shown in diagrams 7025, 7026, 7027, 7028 and 7029.

(3) The sign shown in diagram—

- (a) 554 when varied to “Flood” or “No smoking”;
- (b) 554.2 when placed in conjunction with the plate shown in diagram 554.3; or
- (c) 562 when placed in combination with the plate shown in diagram 563 when indicating “Accident” or when varied to “Census”, “Dust cloud”, “Fallen tree”, “Frost damage”, “Overhead cable repairs”, “Runners in road”, “Smoke” or “Walkers in road”,

may be retained only for so long as the hazard indicated by the sign continues to exist or is expected to recur in the near future.

(4) The sign shown in diagram 633, 636.2 (except when varied to show the name of a traffic authority), 829.1, 829.2, 829.3, 829.4, 829.5 or 1063 may be placed on or near a road only by a constable in uniform or a person acting under the instructions or authority of the chief officer of police.

(5) The sign shown in diagram 829.5 may only be placed on or near a road in an area where police speed checks are from time to time carried out.

(6) The sign shown in diagram 830, 830.1, 830.3, 831 or 832 may be placed on or near a road in connection with a traffic census, if and only if the taking of that census on that road has been approved—

- (a) by the traffic authority for the road;
- (b) by the chief officer of police of the police area in which the road is situated; and
- (c) by or on behalf of the Secretary of State.

(7) The sign shown in diagram 950 may be placed in combination with the plate shown in diagram 950.1—

*Status: This is the original version (as it was originally made). This item of legislation is currently only available in its original format.*

- (a) when the plate is varied to “Cycle event”, only while a cycle rally or similar event is in progress;
- (b) in any other case except when the plate is varied to “Cycles crossing”, only while the training or testing of child cyclists is in progress.

### **Placing of signs varied to show metric units**

**40.**—(1) Where the indication given by the sign shown in diagram 629.1 is varied in accordance with regulation 17 and item 2 of Schedule 16, that sign may be placed only in combination with another sign of the same type whose indication has not been so varied.

(2) Paragraph (1) shall also apply when the sign shown in diagram 629.1 is incorporated as a symbol into another sign.

### **Mounting and backing of signs**

**41.**—(1) Subject to paragraphs (2) and (3), where a sign (other than a sign referred to in paragraph (4), (5) or in direction 43 or 44) in a diagram in Schedules 1 to 5 and 7, Part II of Schedule 10 or Schedule 12, or a sign of the type prescribed by regulation 53, is mounted on a post or other support specially provided for the purpose (“the post”), that part of the post which extends above ground level shall be of any single colour or in its natural colour.

(2) Where the post is not likely to be readily visible to pedestrians or cyclists, a yellow or white band not less than 140 nor more than 160 millimetres deep may be provided on the post, the lower edge of the band being not less than 1500 nor more than 1700 millimetres above ground level.

(3) Where the support provided for a portable sign comprises several components, instead of complying with paragraphs (1) and (2), the components need not all be of the same colour provided that each is of a single colour or in its natural colour.

(4) Where a beacon or lamp of a kind prescribed by regulation 54 or 55 is mounted on a structure specially provided for the purpose, the structure shall be coloured grey, red, white or yellow, or in alternate bands of red and white or of black and white.

(5) The post provided for the mounting of the sign shown in diagram 7031 shall be coloured in alternate black and yellow bands each 300 millimetres deep with a black band uppermost below the bottom of the sign face, and the yellow bands may be reflectorised.

(6) The sign shown in diagram 7104 or 7105 may be mounted on an object of the size, colour and type of the sign shown in diagram 7101.1.

(7) An identification code for maintenance purposes may be indicated, in characters not exceeding 25 millimetres in height, on the post on which a sign is mounted.

**42.**—(1) The back of any sign shown in a diagram in Schedules 1 to 5, 7, Part II of Schedule 10 or in Schedule 12, or prescribed by regulation 53, other than the sign shown in diagram 651, 970, 971, 972, 973.2, 973.3, 2610, 2610.1, 2610.2, 7101.1, 7102, 7103, 7104 or 7105 shall be coloured—

- (a) black if the sign is mounted on the same post as that on which light signals prescribed by regulation 33(1) (or those signals as varied in accordance with regulation 34) or light signals prescribed by regulation 33(2) and regulation 35 are mounted; or
- (b) grey, black or in a non-reflective metallic finish in any other case, except that—
  - (i) information about sites for placing and the ownership of the sign and an identification code for maintenance purposes may be indicated on the back of the sign in characters not exceeding 25 millimetres in height, where they are shown in a contrasting colour, or in characters not exceeding 50 millimetres in height, where they are embossed in the same colour; and



- (ii) information about the manufacture of the sign required in order to comply with British Standard Specification BS 873 or a corresponding EEA Standard, occupying an area not exceeding 30 square centimetres, may be indicated on the back of the sign in characters not exceeding 5 millimetres in height.

(2) Paragraph (1) shall apply to the back of any backing board or other fitting provided for the assembly of such a sign as is referred to in paragraph (1) (including any container enclosing apparatus for the illumination of such a sign).

(3) The back of the sign shown in diagram 7104 or 7105 shall be coloured grey, red, white, black or yellow, except that—

- (a) information about sites for placing and the ownership of the sign may be indicated on the back of the sign in characters not exceeding 50 millimetres in height, where they are shown in a contrasting colour, or in characters not exceeding 80 millimetres in height, where they are embossed in the same colour; and
- (b) information about the manufacture of the sign required in order to comply with British Standard Specification BS 873 or a corresponding EEA Standard, occupying an area not exceeding 30 square centimetres, may be indicated on the back of the sign in characters not exceeding 5 millimetres in height.

(4) The back of the sign shown in diagram 651, 970, 971, 972, 973.2, 973.3, 2610, 2610.1 or 2610.2 may be of any colour.

(5) The front of any backing board for a sign mounted otherwise than as described in paragraph (1) (a) shall be coloured either grey or yellow.

(6) A yellow backing board for a sign (except one for the sign shown in diagram 2402.1) shall be rectangular in shape.

(7) A backing board for the sign shown in diagram 2402.1 may be of any shape including rectangular.

(8) The sign shown in diagram 2403.1 shall not be mounted on a backing board with any other sign.

(9) In this direction “backing board” in relation to a sign includes any background (except a wall to which the sign is affixed) against which the sign is displayed.

#### **Mounting of the sign shown in diagram 781**

**43.** The sign shown in diagram 781 shall be mounted on two posts and so much of each post as extends above ground level shall be coloured black and white in alternate horizontal bands, each band being not less than 250 nor more than 335 millimetres deep.

#### **Mounting of the signs shown in diagrams 560 and 561**

**44.—(1)** The sign shown in diagram 560 or 561 shall be so placed that the top of the sign is not less than 550 nor more than 1000 millimetres above the surface of the adjacent carriageway.

(2) Where the sign shown in diagram 560 or 561 is mounted on a post specially provided for the purpose that part of the post which extends above ground level may be—

- (a) of any single colour; or
- (b) coloured black and white in alternate horizontal bands, each band being not less than 225 nor more than 350 millimetres deep.

(3) The signs shown in diagrams 560 and 561 shall be so erected as to display—

- (a) the colour red on the left hand edge of the carriageway as viewed by the drivers of approaching vehicles; and

*Status: This is the original version (as it was originally made). This item of legislation is currently only available in its original format.*

- (b) the colour white on the right hand edge of the carriageway when so viewed, unless the edge is the edge of the carriageway of a dual carriageway road or a one-way road when the colour amber shall be displayed.

### **Mounting of refuge indicator lamps**

**45.**—(1) This paragraph applies where the lamp prescribed by regulation 57 is mounted on a post specially provided for the purpose.

(2) Subject to paragraph (4), if the post is placed at a zebra crossing and yellow globes are attached to the post, the part of the post between ground level and the point where the yellow globes are mounted or attached shall be coloured black and white in alternate horizontal bands and—

- (a) the lowest band shall be coloured black and not less than 275 millimetres nor more than 1 metre deep; and
- (b) each other band shall be not less than 275 nor more than 335 millimetres deep, and

the remaining part of the post shall be coloured in accordance with paragraph (3).

(3) Subject to paragraph (4), if the post is placed elsewhere or at a zebra crossing, but without yellow globes attached to it, the post shall be coloured grey or black but with two white bands (each band being not less than 275 nor more than 335 millimetres deep) so arranged that—

- (a) not less than 275 nor more than 335 millimetres extend between the nearest edges of the two bands; and
- (b) the upper edge of the uppermost band is not less than 275 nor more than 335 millimetres below the lowest part of the lamp,

and the white bands may be internally illuminated.

(4) Where the post consists of aluminium, concrete or galvanised metal it may remain in its natural colour.

(5) In this direction “yellow globes” means globes in relation to which Part I of Schedule 1 to the Zebra, Pelican and Puffin Pedestrian Crossings Regulations 1997(62) is complied with.

### **Mounting and backing of light signals, matrix signs and warning lights**

**46.**—(1) The light signals prescribed by regulation 33, 34, 35, 37, 39, 41, 44, 45, 47, 48, 49 or 52, the matrix signals prescribed by regulation 46 and the warning lights prescribed by regulations 50 and 51 may be placed on or near a road only if they are so placed that they face the stream of traffic to which they are intended to convey the warnings, information, requirements, restrictions or prohibitions prescribed by the Regulations.

(2) A container enclosing the lamps of a type of light signals, matrix sign or warning light mentioned in paragraph (1) shall be coloured black except that—

- (a) if a container encloses lamps of the light signals prescribed by regulation 37, 44 or 45, the matrix sign prescribed by regulation 46 or the warning lights prescribed by regulation 50 or 51, it may be coloured grey instead of black;
- (b) the back of a container enclosing the signals shown in diagrams 4003, 4003.1, 4003.3, 4003.4, 4003.6 or 4003.7 may be coloured yellow; and
- (c) the container may have a white border not less than 45 nor more than 55 millimetres wide.

(3) Any of the kinds of light signals mentioned in paragraph (1) other than the signals prescribed by regulation 39(1) may be mounted on a backing board, which shall be coloured black and may have a white border not less than 45 nor more than 55 millimetres wide.

---

(62) Part I of S.I. 1997/2400.

(4) In the case of the light signals prescribed by regulation 39(1) the back of the backing board shown in diagram 3014 may be coloured black or grey.

(5) In the case of the matrix signs prescribed by regulation 46, an identification number may be shown on the front of the backing board below the signal or on the post on which the signal is mounted and, in the case of other light signals, an identification number and name, and a telephone number for use in an emergency, may be shown on the post on which the signals are mounted.

(6) Without prejudice to paragraph (8) and subject to the exceptions in paragraph (7), where light signals prescribed by any of the regulations specified in paragraph (1) or shown in a diagram in Part I of Schedule 10 or in Schedule 11 are mounted on a post specially provided for the purpose, that part of the post which extends above ground level shall be either—

- (a) coloured grey, black, brown, dark green or dark blue; or
- (b) in a non-reflective metallic finish.

(7) Paragraph (6) is subject to the following exceptions—

- (a) the post may be marked with a yellow or white band not less than 140 nor more than 160 millimetres deep, the lower edge of the band being not less than 1500 nor more than 1700 millimetres above ground level; and
- (b) where the light signals prescribed by regulation 33(1) or (2) are installed temporarily, the containers in which the posts are placed may be coloured with alternate red and white horizontal stripes.

(8) The portable light signals prescribed by regulation 35, instead of being mounted on a post coloured in accordance with paragraph (6), may be mounted on a post coloured yellow (but having no yellow or white band as specified in paragraph (7)) or on a tripod or other support coloured yellow.

#### **Placing of road marking shown in diagram 1001 or 1001.2 in conjunction with light signals**

47.—(1) The light signals prescribed by regulation 33(1) may be placed only in conjunction with the road marking shown in diagram 1001 or, subject to direction 18(2), 1001.2.

(2) The light signals prescribed by regulation 33(2) or 39(1) may be placed only in conjunction with the road marking shown in diagram 1001.

(3) This direction shall not apply to light signals while works which necessitate the temporary removal of a road marking are being executed on a road near the light signals.

#### **Placing of road marking shown in diagram 1014 in conjunction with the road marking shown in diagram 1013.1 or 1013.3**

48.—(1) At least one road marking of the type shown in diagram 1014 shall be placed in conjunction with a road marking of the type shown in diagram 1013.1 or 1013.3 on the length of carriageway which extends backwards from the commencement of any continuous line marked on the carriageway as a part of the road marking shown in diagram 1013.1 or 1013.3, such commencement being viewed in the direction of travel of a vehicle driven so as to have and keep that continuous line on its right hand or off side in accordance with regulation 26(2)(b).

(2) Paragraph (1) shall not apply where the commencement so viewed of a continuous line on the carriageway of a road falls immediately after—

- (a) the point where a central reservation ends; or
- (b) a roundabout from which traffic enters the carriageway.

(3) For the purposes of paragraph (1), where a continuous line marked on the carriageway of a road as part of the road marking shown in diagram 1013.1 or 1013.3 is interrupted at a junction

*Status: This is the original version (as it was originally made). This item of legislation is currently only available in its original format.*

or by a refuge and recommences immediately after the interruption, the line shall be treated as if it continued through the interruption.

(4) If more than one road marking of the type shown in diagram 1014 is placed on a length of carriageway, then the road markings shall be so spaced apart that one follows in line behind the other.

### **Placing of road marking shown in diagram 1001.3 (zig-zag lines)**

**49.**—(1) In this direction “relevant crossing facility” means a signal-controlled crossing facility—

- (a) at which there is placed the signal shown in diagram 4003.2, 4003.4, 4003.5 or 4003.7; and
- (b) which is not situated at a junction at which the priority between motor vehicles is regulated by traffic light signals.

(2) Subject to paragraphs (4) to (6), zig-zag lines shall be placed on the approaches to each side of a relevant crossing facility so as to form controlled areas as defined by regulation 27(1).

(3) Zig-zag lines shall not be placed on a road except in accordance with—

- (a) paragraph (2); or
- (b) regulations made, or having effect as if made, under section 25 of the 1984 Act (pedestrian crossings regulations).

(4) So long as the condition in paragraph (5) is complied with, paragraph (2) shall not apply where, in accordance with an authorisation given under section 64(1) or (2) of the 1984 Act, a relevant crossing facility has been provided on a road before 1st April 2003 but without the placing of zig-zag lines on the approaches as mentioned in paragraph (2).

(5) The condition is that the signs and markings indicating the facility are maintained in accordance with the authorisation under which they were placed and any special directions under section 65 of the 1984 Act that were given in conjunction with the authorisation.

(6) Paragraphs (4) and (5) shall cease to have effect on 1st January 2007.

### **Placing of signs and light signals shown in Schedule 11**

**50.** The light signals prescribed by regulation 37(1) and 45 and the signs and light signals shown in any diagram in Schedule 11 may be displayed only on or near—

- (a) a motorway; or
- (b) an all-purpose dual carriageway road.

**51.**—(1) The light signals prescribed by regulation 37(1) shall not be displayed over or in relation to a traffic lane in conjunction with the sign shown in diagram 6001, 6002, 6003, 6006, 6006.1, 6008, 6009, 6009.1, 6009.2, 6011, 6011.1 or 6012.

(2) Paragraph (1) shall not apply to the signs shown in diagrams 6006.2, 6008.1 and 6009.3 when the light signals prescribed by regulation 37(1) are placed at the side of a carriageway so as to convey prohibitions or requirements applying to all traffic proceeding along the carriageway in a particular direction.

**52.** The sign shown in diagram 6002, 6021 or 6031.1 may be displayed only over a traffic lane and the sign shown in diagram 6006, 6006.1, 6006.2, 6008, 6008.1, 6009, 6009.1, 6009.2, 6009.3, 6022 or 6032.1 may be displayed only at the side of the carriageway to which the indications given by the sign relate, or projecting over part of that carriageway, so as to convey warnings, prohibitions or requirements applying to all traffic proceeding along the carriageway in a particular direction.

### **Placing of portable light signals prescribed by regulation 35**

**53.**—(1) A traffic authority may, pursuant to section 65(1) of the 1984 Act, cause or permit the placing of the portable light signals prescribed by regulation 35 if and only if—

- (a) permission is given in writing, or in a case of urgency, given orally and confirmed in writing as soon as reasonably practicable thereafter; and
- (b) either—
  - (i) the written permission of the authority includes express approval to the placing of the signals at a particular site; or
  - (ii) the authority is satisfied that the circumstances of the particular case fall within one of the sets of circumstances specified in paragraph (2).

(2) The sets of circumstances referred to in paragraph (1)(b)(ii) are—

- (a) where the signals are to be operated and maintained by, and are under the regular supervision of, a constable in uniform during the progress of a temporary scheme of traffic control;
- (b) where the signals are placed on a length of road along which—
  - (i) there is no junction carrying vehicular traffic to or from it; and
  - (ii) the width of the carriageway is temporarily restricted so as to carry only one line of traffic;
- (c) where the signals are placed at a level crossing when work in relation to that crossing is being carried out;
- (d) where the signals are placed on a road which is—
  - (i) adjacent to the temporary site of road, building or engineering works; and
  - (ii) is used for the movement of vehicles, materials, plant or equipment within the site of the works.

(3) Nothing in this direction is to be taken to limit or affect the powers of a constable or the chief officer of police under section 67(1) of the 1984 Act (placing of temporary traffic signs on roads in extraordinary circumstances).

### **Placing of signals and other signs at crossings**

**54.** The Schedule to these Directions shall have effect with regard to the placing of—

- (a) vehicular light signals;
- (b) pedestrian light signals; and
- (c) other signs,

at signal-controlled crossing facilities where vehicular traffic is stopped only for the purpose of enabling pedestrians, cyclists or equestrians to cross the carriageway and not for the purpose of regulating the priority of vehicular traffic at a junction.

### **Placing of various light signals**

**55.**—(1) The light signals shown in diagram 4004 may be placed only in combination with the sign shown in diagram 545 together with the plate shown in diagram 546, 547.1 or 547.7.

(2) The light signals shown in diagram 4005 may be placed on or near a road only when the sign shown in diagram 548 in conjunction with the plate shown in diagram 548.1 is placed in advance of those signals.

*Status: This is the original version (as it was originally made). This item of legislation is currently only available in its original format.*

(3) The light signals shown in diagram 4006 may be placed only in conjunction with the light signals shown in diagram 3014.

(4) The sign shown in diagram 4003 may be placed only in conjunction with the light signals shown in diagram 4002.1.

(5) The sign shown in diagram 4003.3 may be placed only in conjunction with the light signals shown in diagram 4003.2.

(6) The sign shown in diagram 4003.6 may be placed only in conjunction with the light signals shown in diagram 4003.5.

(7) The light signals shown in diagram 4002.1 or 4003.1 may be placed only in conjunction with the light signals prescribed by regulation 33(1) or (2).

(8) The light signals shown in diagram 4003.2 or 4003.4 may be placed only in conjunction with the light signals prescribed by regulation 33(1).

(9) The light signals shown in diagram 4003.5 or 4003.7 may be placed only in conjunction with the light signals prescribed by regulation 33(1).

(10) The light signal shown in diagram 776 may be placed only at or near a level crossing and the legend shall be displayed to road traffic in black letters on a red background which is internally illuminated by means of electricity only when a railway vehicle or tramcar has just passed over the level crossing and another is approaching.

(11) The light signals of the kinds prescribed by regulation 33(1), 34 or 39 may be placed on or near a road to face traffic proceeding in a particular direction if and only if—

- (a) at least two identical sets of signals are placed so as to face traffic proceeding in that direction; and
- (b) at least one of those sets of signals is a set of primary signals.

### **Approval of types of sign and signals by the Secretary of State**

**56.**—(1) The signs to which this direction applies may be placed on or near a road only if at the time that they are first placed they meet the requirements specified in paragraph (3).

(2) This direction applies to—

- (a) the signals prescribed by regulations 33, 34, 35, 37, 39, 41, 44, 45, 47, 48, 49 and 52;
- (b) the matrix signs prescribed by regulation 46;
- (c) the warning lights prescribed by regulations 50 and 51;
- (d) the audible and tactile signals prescribed by regulations 47 and 49;
- (e) the signs shown in diagrams 618.3A, 776 and 2509.1;
- (f) the signs shown in diagrams 2505, 2505.1, 2506, 2507, 2508, 2510, 2511, 2512 and 2513, if varied to include a variable element;
- (g) any light signals or signs shown in a diagram in Schedule 11;
- (h) variable message signs and any other signs not continuously in use over a period of 24 hours and which are capable of being brought into and taken out of use by the operation of any electrical or other apparatus.

(3) The requirements referred to in paragraph (1) are—

- (a) in all cases, that any equipment (including the content of all instructions stored in, or executable by it) used in connection with the signal or sign is of a type approved in writing by the Secretary of State or the Scottish Ministers; and

(b) in the case of the signals prescribed by regulation 39 or regulation 52, that any such equipment is of a type so approved as appropriate having regard to the number and disposition and the site of those signals.

(4) Paragraph (3)(b) does not apply to signals displayed to indicate the effect of orders made, or having effect as if made, under section 1 of the Level Crossings Act 1983(63).

(5) If, after a signal or sign has been placed in accordance with an approval under paragraph (3), the signal, sign or any equipment used in connection with the signal or sign is altered, the signal or sign shall not be further used unless that alteration is approved in writing by or on behalf of the Secretary of State.

(6) When any signal or sign has been placed in accordance with an approval under paragraph (3), the signal, the sign or any equipment used in connection with the signal or sign, including any alterations approved in accordance with paragraph (5), shall be regarded as continuing to be approved until notice is given in writing by the Secretary of State—

(a) to the traffic authority; and

(b) either—

(i) to the supplier of the sign, signal or equipment; or

(ii) where an alteration has been approved in accordance with paragraph (3), to the person who carried out the alteration,

of a date after which the signal, sign or equipment is no longer to be so regarded.

(7) Where notice is given under paragraph (6) that a signal, sign or any equipment used in connection with the signal or sign is no longer to be regarded as being approved that signal, sign or equipment shall be removed from the road on or before the date given in the notice.

## Studs

**57.**—(1) A stud incorporating reflectors or retroreflecting material, but no steady or intermittent light source, may be placed on a road if and only if—

(a) it is a stud of a type which meets the requirements of paragraph (5); or

(b) it is of a type approved by the Secretary of State in accordance with direction 58.

(2) A stud incorporating both reflectors or retroreflecting material and a steady or intermittent light source, may be placed on a road if and only if—

(a) so far as it incorporates reflectors or retroreflecting material it is of a type that meets the requirements of paragraph (5) and, so far as it incorporates a steady or intermittent light source, it is of a type approved by the Secretary of State in accordance with direction 58; or

(b) it is of a type approved by the Secretary of State in accordance with direction 58.

(3) A stud incorporating a steady or intermittent light source and no reflectors or retroreflecting material may be placed on a road if and only if it is of a type approved by the Secretary of State in accordance with direction 58.

(4) In paragraph (5) “the European Standards” means European Standards EN 1463–1: 1997 and 1463–2: 2000 for retroreflecting road studs.

(5) A type of stud meets the requirements of this paragraph if and only if, being a type of stud which falls within a description specified in column (2) of an item in the table, it meets the performance requirement or test specification of the European Standards specified in column (3) of the item as it applies to studs within the class specified in that column.

**Status:** This is the original version (as it was originally made). This item of legislation is currently only available in its original format.

**Table**

<i>(1)</i> <i>Item</i>	<i>(2)</i> <i>Description of stud</i>	<i>(3)</i> <i>Requirement or test specification and class</i>
1.	Non depressible road stud	Dimensions : height – class H1 or H2
2.	Depressible road stud	Dimensions : height – class H1, H2 or H3
3.	Permanent road stud	Dimensions : maximum horizontal dimension exposed to traffic: HD1
4.	Temporary road stud	Dimensions : minimum horizontal dimension exposed to traffic: HDT1
5.	Permanent road stud	Night-time visibility : photometric requirements – class PRP1
6.	Temporary road stud	Night-time visibility : photometric requirements – class PRT1
7.	Temporary road stud	Daytime visibility : colour of body of stud — class DCR1 fluorescent green-yellow — class DV1
8.	Any stud	Colorimetric requirements – class NCR1 for white, amber, red or green retroreflectors only
9.	Any stud	Primary assessment – class S1
10.	Any stud	Night-time visibility assessment – class R1, R2 or R3

NOTE: Expressions used in the table bear the same meanings as in the European Standards.

### **Approval of types of stud by the Secretary of State**

**58.**—(1) Subject to paragraph (2) the Secretary of State may approve in writing a type of stud for the purposes of direction 57(1)(b), (2) or (3).

(2) To the extent that a type of stud incorporates reflectors or retroreflecting material, the Secretary of State may approve it under paragraph (1) only for the purpose of testing it in order to determine whether it meets the requirements of direction 57(5).

(3) When any stud has been placed in accordance with an approval under paragraph (1), the stud shall cease to be regarded as being of an approved type—

- (a) in a case where approval has been granted for a specified period only, on whichever is the earlier of—
  - (i) the date on which that period expires; or
  - (ii) the date specified in a notice in writing given by the Secretary of State to the supplier and to the traffic authority as the date after which the stud is no longer to be so regarded;



*Status:* This is the original version (as it was originally made). This item of legislation is currently only available in its original format.

- (b) in a case where approval has been granted without any express time limit, on the date specified in a notice in writing given by the Secretary of State to the supplier and to the traffic authority as the date after which the stud is no longer to be so regarded.
- (4) All studs ceasing to be of an approved type shall be removed on or before the appropriate date in accordance with paragraph (2).

### Special directions

59. Nothing in these Directions shall be taken to limit the power of the Secretary of State, the Scottish Ministers and the National Assembly of Wales<sup>(64)</sup> by special direction to dispense with, add to or modify any of the requirements of these Directions in their application to any particular case.

## SCHEDULE

Direction 54

### PLACING OF SIGNALS AND OTHER SIGNS AT SIGNAL-CONTROLLED CROSSING FACILITIES

#### Interpretation

1. In this Schedule—

“approaching vehicular traffic” in relation to a crossing means vehicular traffic approaching the crossing along the carriageway across which the crossing is placed;

“crossing” means a signal-controlled crossing facility;

“far side signals” means light signals of the size, colour and type shown in diagram 4002.1, 4003.2 and 4003.5;

“indicator” means a sign of the size, colour and type shown in diagram 4003, 4003.3 and 4003.6;

“near side signals” means a sign of the size, colour and type shown in diagram 4003.1, 4003.4 and 4003.7;

“one-way road” means a road on which the driving of vehicles otherwise than in one particular direction is prohibited;

“system of staggered crossings” means two crossings provided on a road on which there is a central reservation and where—

(a) there is one crossing on each side of the central reservation; and

(b) taken together the two crossings do not lie in a straight line;

“two-way street” means a road which is not a one-way road; and

references to the left or right hand side of a crossing are to the left or right hand side as viewed by approaching vehicular traffic.

#### Vehicular light signals on a two-way street

2. Subject to paragraph 4, on a two-way street, the number and disposition of light signals of the kind prescribed by regulation 33 which are placed at a crossing to control approaching vehicular traffic shall, in the case of a crossing of the type specified in column (2) of an item in the table, be as specified in column (3) of that item.

---

(64) See [S.I. 1999/672](#) and [1750](#).

**Status:** This is the original version (as it was originally made). This item of legislation is currently only available in its original format.

**Table**

<i>(1)</i> <i>Item</i>	<i>(2)</i> <i>Type of crossing on a two-way street</i>	<i>(3)</i> <i>Light signals to control approaching vehicular traffic</i>
1.	Crossing not forming part of a system of staggered crossings and not having a refuge or central reservation within the limits of the crossing	One primary signal on the left hand side of the crossing and one secondary signal on the right hand side of the crossing
2.	Crossing not forming part of a system of staggered crossings and having a refuge or central reservation within the limits of the crossing	One primary signal on the left hand side of the crossing and one secondary signal on the right hand side of the crossing or on the refuge or central reservation
3.	Crossing forming part of a system of staggered crossings	One primary signal on the left hand side of the crossing and one other signal, which may be either a primary or a secondary signal, on the right hand side of the crossing

**Vehicular light signals on a one-way road**

3. Subject to paragraph 4, on a one-way road, the number and disposition of light signals of the kind prescribed by regulation 33 to be placed at a crossing to control approaching vehicular traffic shall, in the case of a crossing of the type specified in column (2) of an item in the table, be as specified in column (3) of that item.

**Table**

<i>(1)</i> <i>Item</i>	<i>(2)</i> <i>Type of crossing on a one-way road</i>	<i>(3)</i> <i>Light signals to control approaching vehicular traffic</i>
1.	Crossing not forming part of a system of staggered crossings and not having a refuge or central reservation within the limits of the crossing	One primary signal on the left hand side of the crossing and a signal, which may be either a primary or a secondary signal, on the right hand side of the crossing
2.	Crossing not forming part of a system of staggered crossings and having a refuge or central reservation within the limits of the crossing	One primary signal on each side of the crossing and a signal, which may be either a primary signal (in which case it must be on the refuge or the central reservation) or a secondary signal
3.	Crossing forming part of a system of staggered crossings	One primary signal on the left hand side of the crossing and a

**Status:** This is the original version (as it was originally made). This item of legislation is currently only available in its original format.

<i>(1)</i> Item	<i>(2)</i> Type of crossing on a one-way road	<i>(3)</i> Light signals to control approaching vehicular traffic signal, which may be either a primary signal or a secondary signal, on the right hand side of the crossing
--------------------	--	---

#### **Additional vehicular light signals**

4. In addition to the signals required to be placed at a crossing by paragraph 2 or 3, the traffic authority may place such other primary or secondary signals as it thinks fit.

#### **Far side light signals at crossings**

5.—(1) Except where near side signals have been placed at a crossing in accordance with paragraph 6, at least one set of far side signals and one indicator shall be placed at each end of a crossing.

(2) Each set of far side signals shall be so placed as to be clearly visible to any person on the opposite side of the crossing who wishes to use the crossing.

(3) Where a crossing has a refuge or central reservation within its limits, at least one indicator shall be placed on the refuge or central reservation.

(4) Each indicator shall be so placed that the push button on it may be reached by any person wishing to press it.

(5) Where far side signals and indicators have been placed at a crossing in accordance with this paragraph—

- (a) there may be placed as many devices of the kind prescribed by regulation 49(8) as the traffic authority think fit; and
- (b) no near side signals shall be placed at that crossing.

#### **Near side signals at crossings**

6.—(1) Except where far side signals have been placed at a crossing in accordance with paragraph 5, at least one set of near side signals shall be placed at each end of a crossing.

(2) Where a crossing has a refuge or central reservation within its limits, at least one set of near side signals shall be placed on the refuge or central reservation.

(3) Each set of near side signals shall be so placed—

- (a) as to be clearly visible to any person who wishes to use the crossing; and
- (b) that the push button on it may be reached by any person wishing to press it.

(4) In addition to the near side signals required by this paragraph to be placed at a crossing—

- (a) there may be placed as many devices of the kind prescribed by regulation 49(5) or (8) as the traffic authority think fit; and
- (b) no far side signals or indicators shall be placed at that crossing.

**Status:** This is the original version (as it was originally made). This item of legislation is currently only available in its original format.

Signed by authority of the Secretary of State

16th December 2002

David Jamieson  
Parliamentary Under Secretary of State,  
Department for Transport

---

## EXPLANATORY NOTE

*(This note is not part of the Instrument)*

This Instrument consolidates with substantial amendments the Traffic Signs Regulations and General Directions 1994 and their amending instruments. Part I comprises the Traffic Signs Regulations 2002 and their 19 Schedules and Part II consists of the Traffic Signs General Directions 2002 which have one Schedule.

Regulation 1 enables Part I to be cited on its own as the Traffic Signs Regulations 2002 and the whole instrument (i.e. the Regulations and General Directions) to be cited by the collective title of the Traffic Signs Regulations and General Directions 2002. The Regulations consolidated with amendments by Part I are revoked by regulation 2. Regulation 3, however, provides for certain signs prescribed by the Traffic Signs Regulations 1994 or by earlier Regulations, but not prescribed by these new Regulations, to be treated as prescribed by these Regulations until particular dates. Regulations 4–6 make general provisions as to the interpretation of the Regulations and regulation 7 deals with the interpretation of the tables appearing below the diagrams in Schedules 1–13. A general saving for the powers of the Secretary of State, the Scottish Ministers and the National Assembly for Wales to authorise traffic signs of a character not prescribed by the Regulations is contained in regulation 8 and regulation 9 makes it clear that nothing in the Regulations is to have effect to authorise anyone to place signs indicating a temporary obstruction. The relevant Regulations for this purpose are the Traffic Signs (Temporary Obstructions) Regulations 1997 ([S.I. 1997/3053](#)).

Regulation 10 prescribes traffic signs for the purposes of section 36 of the Road Traffic Act 1988 (signs whose indication it is an offence to contravene) and for the purposes of column 5 of Schedule 2 to the Road Traffic Offenders Act 1988 (signs whose contravention is an offence involving discretionary disqualification). Regulation 11 provides that, subject to the provisions of the Regulations, the sign for conveying information or a warning, requirement, restriction, prohibition or speed limit of the description specified in the caption to a diagram in Schedules 1–7, Part II of Schedule 10 or Schedule 12 must be of the size, colour and type shown in the diagram. Regulation 12 makes provision as to the extent to which it is permissible to vary the dimensions for the signs shown in the diagrams in the Schedules and regulation 13 makes provision as to the proportions and form of letters, numerals, symbols and other characters included in the diagrams. Regulation 14 prescribes signs that can be attached to vehicles.

Regulations 15 and 16 provide for particular warning and regulatory signs; regulation 17 and Schedule 16 make provision as to the permitted variants of the prescribed signs, including variants which are required to be made in particular circumstances. Provision is made for the illumination of signs (including plates) by regulations 18–21 (and Schedule 17) and regulations 20–24 concern buses, bus lanes and bus symbols. Regulations 25–32 and Schedules 6 (road marking diagrams) and

19 (significance of bus stops and bus stand clearway and box junction markings) are concerned with road markings; they indicate the significance of particular markings (regulations 25–29), and specify the permitted variants (regulation 30), the manner of illuminating road markings (regulation 31), the height of markings and the size of studs (regulation 32).

Section 5 (regulations 33–52) concerns light signals and warning lights. Regulations 33–35 prescribe the form of traffic light signals to control vehicular traffic, including portable signals and signals displaying a green arrow. The significance of these signals is prescribed by regulation 36. Equivalent provision is made for light signals for the control of vehicular traffic on motorways and all-purpose dual carriageway roads (regulations 37 and 38), for light signals to control vehicular traffic at level crossings (regulations 39 and 40) and light signals for the control of tramcars (regulations 41 and 42). The meaning of the expression “stop line” in the regulations relating to light signals is given in regulation 43. Regulations 44 to 46 prescribe light signals for the control of vehicular traffic travelling in lanes and for warning signals and matrix signs for motorways and all-purpose dual carriageway roads. Regulations 47–49 make provision for signals to control traffic crossing the carriageway of roads on which vehicular traffic is controlled by light signals. The crossings thereby created will not be crossings of the kind authorised by section 24 of the Road Traffic Regulation Act 1984. Crossing facilities for pedestrians provided in conjunction with traffic light signals are prescribed by regulation 47 and regulations 48 and 49 provide for equestrian crossings for horse riders and “Toucan” crossings, which are combined crossings for pedestrians and cyclists. Regulations 50 to 52 provide for warning lights at crossing places for school children, cattle crossing signs and warning lights and light signals for pedestrians at railway level crossings. The diagrams for the various types of light signal are set out in Schedules 8–11 of the Regulations.

Regulations 53 to 58 concern various other traffic signs including temporary signs (regulation 53), flashing beacons (regulation 54), road danger lamps (regulation 55), cones, delineators and cylinders (regulation 56), refuge indicator lamps (regulation 57) and variable message signs (regulation 58 and Schedule 15).

Part II consists of the Traffic Signs General Directions 2002 which are made under section 65 of the Road Traffic Regulation Act 1984. Direction 5 contains a saving for traffic signs placed in conformity with the Traffic Signs General Directions 1994 (revoked by direction 2) or to be treated as placed in conformity with those Directions. Direction 6 requires the sign shown in diagram 601.1 (“STOP”) only to be placed at a site for the first time with the approval of the Secretary of State, the Scottish Ministers or the National Assembly for Wales and direction 7 specifies those signs which can only be placed to indicate the effect of an order or other statutory provision.

Directions 8–11 concern the placing of signs to indicate the start and finish of restrictions (including speed limits) which apply along lengths of road and the placing of repeater signs along those lengths. Directions 12–15 specify signs that can only be placed on particular types of road and direction 16 specifies the circumstances in which a 20mph speed limit sign can be placed. Directions 17–21 specify signs that can only be placed in conjunction with other specified signs and directions 22–26 make provision as to the placing of signs to indicate waiting restrictions including the boundaries of controlled parking zones.

Directions 27–35 concern various signs which are to be placed only at specified sites or for specified purposes and directions 36–39 restrict the placing of temporary signs. Direction 40 provides that where the sign in diagram 629.1 (vehicles exceeding a specified length prohibited) has been varied to give a metric indication, it must be used in conjunction with a sign giving an imperial indication.

Directions 41–46 concern the mounting and backing of various signs and directions 47–55 relate to signs that include light signals. In particular, direction 49 restricts the use of the zig-zag lines in conjunction with traffic light signals and direction 54 introduces the Schedule to the Directions which concerns the combinations of signs to be used at crossings for pedestrians or equestrians and Toucan crossings. (Zebra, Pelican and Puffin crossings are not affected; these are dealt with by the Zebra, Pelican and Puffin Pedestrian Crossing Regulations 1997, [S.I. 1997/2400](#)). Directions 56–58 concern type approval of signs by the Secretary of State and direction 59 is a general saving for the

**Status:** *This is the original version (as it was originally made). This item of legislation is currently only available in its original format.*

powers of the Secretary of State, the Scottish Ministers and the National Assembly for Wales to give special directions regarding the placing of traffic signs.

These Regulations were notified in draft to the European Commission in accordance with Directive [98/34/EC](#) as amended by Directive [98/48/EC](#). Copies of the Directives can be obtained from the Stationery Office.