

This document is meant purely as a documentation tool and the institutions do not assume any liability for its contents

► **B**

► **M6 COUNCIL DIRECTIVE**

of 20 March 1970

on the approximation of the laws of the Member States on measures to be taken against air pollution by emissions from motor vehicles

(70/220/EEC) ◀

(OJ L 76, 6.4.1970, p. 1)

Amended by:

| | Official Journal | | |
|---|------------------|------|------------|
| | No | page | date |
| ► <u>M1</u> Council Directive 74/290/EEC of 28 May 1974 | L 159 | 61 | 15.6.1974 |
| ► <u>M2</u> Commission Directive 77/102/EEC of 30 November 1976 | L 32 | 32 | 3.2.1977 |
| ► <u>M3</u> Commission Directive 78/665/EEC of 14 July 1978 | L 223 | 48 | 14.8.1978 |
| ► <u>M4</u> Council Directive 83/351/EEC of 16 June 1983 | L 197 | 1 | 20.7.1983 |
| ► <u>M5</u> Council Directive 88/76/EEC of 3 December 1987 | L 36 | 1 | 9.2.1988 |
| ► <u>M6</u> Council Directive 88/436/EEC of 16 June 1988 | L 214 | 1 | 6.8.1988 |
| ► <u>M7</u> Council Directive 89/458/EEC of 18 July 1989 | L 226 | 1 | 3.8.1989 |
| ► <u>M8</u> Commission Directive 89/491/EEC of 17 July 1989 | L 238 | 43 | 15.8.1989 |
| ► <u>M9</u> Council Directive 91/441/EEC of 26 June 1991 | L 242 | 1 | 30.8.1991 |
| ► <u>M10</u> Council Directive 93/59/EEC of 28 June 1993 | L 186 | 21 | 28.7.1993 |
| ► <u>M11</u> Directive 94/12/EC of the European Parliament and the Council of 23 March 1994 | L 100 | 42 | 19.4.1994 |
| ► <u>M12</u> Commission Directive 96/44/EC of 1 July 1996 | L 210 | 25 | 20.8.1996 |
| ► <u>M13</u> Directive 96/69/EC of the European Parliament and of the Council of 8 October 1996 | L 282 | 64 | 1.11.1996 |
| ► <u>M14</u> Commission Directive 98/77/EC of 2 October 1998 | L 286 | 34 | 23.10.1998 |
| ► <u>M15</u> Directive 98/69/EC of the European Parliament and of the Council of 13 October 1998 | L 350 | 1 | 28.12.1998 |

Amended by:

| | | | |
|--|------|----|-----------|
| ► <u>A1</u> Act of Accession of Denmark, Ireland and the United Kingdom of Great Britain and Northern Ireland | L 73 | 14 | 27.3.1972 |
|--|------|----|-----------|

Corrected by:

- **C1** Corrigendum, OJ L 303, 8.11.1988, p. 36 (88/436/EEC)
- **C2** Corrigendum, OJ L 270, 19.9.1989, p. 16 (89/458/EEC)
- **C3** Corrigendum, OJ L 104, 21.4.1999, p. 31 (98/69/EC)
- **C4** Corrigendum, OJ L 104, 21.4.1999, p. 32 (98/69/EC)

▼B
▼M6

COUNCIL DIRECTIVE
of 20 March 1970

on the approximation of the laws of the Member States on measures to be taken against air pollution by emissions from motor vehicles

(70/220/EEC)

▼B

THE COUNCIL OF THE EUROPEAN COMMUNITIES,

Having regard to the Treaty establishing the European Economic Community, and in particular Article 100 thereof;

Having regard to the proposal from the Commission;

Having regard to the Opinion of the European Parliament⁽¹⁾;

Having regard to the Opinion of the Economic and Social Committee⁽²⁾;

Whereas a regulation of 14 October 1968 amending the *Straßenverkehrs-Zulassungs-Ordnung* was published in Germany in the *Bundesgesetzblatt* Part I of 18 October 1968; whereas that regulation contains provisions on measures to be taken against air pollution by positive-ignition engines of motor vehicles; whereas those provisions will enter into force on 1 October 1970;

Whereas a regulation of 31 March 1969 on the 'Composition of exhaust gases emitted from petrol engines of motor vehicles' was published in France in the *Journal officiel* of 17 May 1969; whereas that regulation is applicable:

- from 1 September 1971, to type-approved vehicles with a new type of engine, that is to say, a type of engine which has never before been installed in a type-approved vehicle;
- from 1 September 1972, to vehicles put into service for the first time;

Whereas those provisions are liable to hinder the establishment and proper functioning of the common market; whereas it is therefore necessary that all Member States adopt the same requirements, either in addition to or in place of their existing rules, in order, in particular, to allow the EEC type — approval procedure which was the subject of the Council Directive⁽³⁾ of 6 February 1970 on the approximation of the laws of the Member States relating to the type approval of motor vehicles and their trailers to be applied in respect of each type of vehicle;

Whereas, however, the present Directive will be applied before the date laid down for the application of the Directive of 6 February 1970; whereas at that time therefore the procedures of this last Directive will not yet be applicable; whereas therefore an *ad hoc* procedure must be laid down in the form of a communication certifying that a vehicle type has been tested and that it satisfies the requirements of this Directive;

Whereas, on the basis of that communication, each Member State requested to grant national type approval of a type of vehicle must be able to ascertain whether that type has been submitted to the tests laid down in this Directive; whereas, to this end, each Member State should inform the other Member States of its findings by sending them a copy of the communication completed for each type of motor vehicle which has been tested;

⁽¹⁾ OJ No C 160, 18.12.1969, p. 7.

⁽²⁾ OJ No C 48, 16.4.1969, p. 16.

⁽³⁾ OJ No L 42, 23.2.1970, p. 1.

▼B

Whereas a longer period of adaptation should be laid down for industry in respect of the requirements relating to the testing of the average emission of gaseous pollutants in a congested urban area after a cold start than in respect of the other technical requirements of this Directive;

Whereas it is desirable to use the technical requirements adopted by the UN Economic Commission for Europe in its Regulation No 15⁽¹⁾ (Uniform provisions concerning the approval of vehicles equipped with a positive-ignition engine with regard to the emission of gaseous pollutants by the engine), annexed to the Agreement of 20 March 1958 concerning the adoption of uniform conditions of approval and reciprocal recognition of approval for motor vehicle equipment and parts;

Whereas, furthermore, the technical requirements must be rapidly adapted to take account of technical progress; whereas, to this end, provision should be made for application of the procedure laid down in Article 13 of the Council Directive of 6 February 1970 on the type approval of motor vehicles and their trailers;

HAS ADOPTED THIS DIRECTIVE:

▼M14*Article 1*

For the purposes of this Directive:

- ‘vehicle’ means any vehicle as defined in Annex II Section A to Directive 70/156/EEC,
- ‘automotive LPG or NG equipment’ means any assembly of automotive LPG or NG components designed to be fitted on one or more given types of motor vehicle, which can be approved as a separate technical unit as defined in Article 4(1)(d) of Directive 70/156/EEC,
- ‘replacement catalytic converter’ means a catalytic converter or an assembly of catalytic converters intended to replace an original equipment catalytic converter on a vehicle approved according to Directive 70/220/EEC, which can be approved as a separate technical unit as defined in Article 4(1)(d) of Directive 70/156/EEC.

▼B*Article 2*

No Member State may refuse to grant EEC type approval or national type approval of a vehicle on grounds relating to air pollution by gases from positive-ignition engines of motor vehicles:

- from 1 October 1970, where that vehicle satisfies both the requirements contained in Annex I, with the exception of those in items 3.2.1.1 and 3.2.2.1, and the requirements contained in Annexes II, IV, V and VI;
- from 1 October 1971, where that vehicle satisfies, in addition, the requirements contained in items 3.2.1.1 and 3.2.2.1 of Annex I and in Annex III.

▼A1*Article 2a*

No Member State may refuse or prohibit the sale or registration, entry into service or use of a vehicle on grounds relating to air pollution by gases from positive-ignition engines of motor vehicles if that vehicle satisfies the requirements set out in Annexes I, II, III, IV, V and VI.

⁽¹⁾ ECE (Geneva) Document W/TRANS/WP 29/293/Rev. 1, 11.4.1969.

▼B*Article 3*

1. On application being made by a manufacturer or his authorised representative, the competent authorities of the Member State concerned shall complete the sections of the communication provided for in Annex VII. A copy of that communication shall be sent to the other Member States and to the applicant. Other Member States which are requested to grant national type approval for the same type of vehicle shall accept that document as proof that the tests provided for have been carried out.
2. The provisions of paragraph 1 shall be revoked as soon as the Council Directive of 6 February 1970 on the type approval of motor vehicles and their trailers enters into force.

Article 4

The Member State which has granted type approval shall take the necessary measures to ensure that it is informed of any modification of a part or characteristic referred to in item 1.1 of Annex I. The competent authorities of that Member State shall determine whether fresh tests should be carried out on the modified prototype and whether a fresh report should be drawn up. Where such tests reveal failure to comply with the requirements of this Directive, the modification shall not be approved.

Article 5

The amendments necessary for adjusting the requirements of ►**M15** Annexes I to XI ◀ so as to take account of technical progress shall be adopted in accordance with the procedure laid down in Article 13 of the Council Directive of 6 February 1970 on the type approval of motor vehicles and their trailers.

Article 6

1. Member States shall adopt provisions containing the requirements needed in order to comply with this Directive before 30 June 1970 and shall forthwith inform the Commission thereof.
2. Member States shall ensure that they communicate to the Commission the text of the main provisions of national law which they adopt in the field covered by this Directive.

Article 7

This Directive is addressed to the Member States.

▼ **M15**

LIST OF ANNEXES

- ANNEX I: Scope, definitions, application for EC type-approval, granting of ec type-approval, requirements and tests, extension of EC type-approval, conformity of production and in-service vehicles, on-board diagnostic (OBD) systems
- Appendix 1:* Verification of production conformity (1st statistical method)
- Appendix 2:* Verification of production conformity (2nd statistical method)
- Appendix 3:* In-service conformity check
- Appendix 4:* Statistical procedure for in-service conformity testing
- ANNEX II: Information document
- Appendix:* Information on text conditions
- ANNEX III: Type I test (verifying the average tailpipe emissions after a cold start)
- Appendix 1:* Operating cycle used for the type I test
- Appendix 2:* Chassis dynamometer
- Appendix 3:* Measurement method on the road-simulation on a chassis dynamometer
- Appendix 4:* Verification of inertias other than mechanical
- Appendix 5:* Description of tailpipe emission-sampling systems
- Appendix 6:* Method of calibrating the equipment
- Appendix 7:* Total system verification
- Appendix 8:* Calculation of the emission of pollutants
- ANNEX IV: Type II test (carbon monoxide emission test at idling speed)
- ANNEX V: Type III test (verifying emissions of crankcase gases)
- ANNEX VI: Type IV test (determination of evaporative emissions from vehicles with positive-ignition engines)
- Appendix 1:* Calibration frequency and methods
- Appendix 2:* Diurnal ambient temperature profile for the diurnal emission test
- ANNEX VII: Type VI test: Verifying the average low ambient temperature carbon monoxide and hydrocarbon tailpipe emissions after a cold start
- ANNEX VIII: Type V test (ageing test for verifying the durability of anti-pollution devices)
- ANNEX IX: Specifications of reference fuels
- ▼ **M14**
- ANNEX IX a: Specifications of gaseous reference fuels
- ▼ **M15**
- ANNEX X: Model EC type-approval certificate
- Appendix:* Addendum to EC information document
- ANNEX XI: On-board-diagnostics (OBD) for motor vehicles
- Appendix 1:* Functional aspects of OBD systems
- Appendix 2:* Essential characteristics of the vehicle family
- ▼ **M14**
- ANNEX XII: EC type-approval for a vehicle fuelled by LPG or natural gas with regards to its emissions
- ANNEX XIII: EC type-approval of replacement catalytic converter as separate technical unit
- Appendix 1:* Information document
- Appendix 2:* EC type-approval certificate
- Appendix 3:* EC type-approval mark

▼ M9*ANNEX I***▼ M15****SCOPE, DEFINITIONS, APPLICATION FOR EC TYPE-APPROVAL, GRANTING OF EC TYPE-APPROVAL, REQUIREMENTS AND TESTS, EXTENSION OF EC TYPE-APPROVAL, CONFORMITY OF PRODUCTION AND IN-SERVICE VEHICLES, ON-BOARD DIAGNOSTIC (OBD) SYSTEMS****▼ M9**

1. SCOPE

▼ M15

This Directive applies to

- tailpipe emissions at normal and low ambient temperature, evaporative emissions, emissions of crankcase gases, the durability of anti-pollution devices and on-board diagnostic (OBD) systems of motor vehicles equipped with positive-ignition engines, and
- tailpipe emissions, the durability of anti-pollution devices and on-board diagnostic (OBD) systems of vehicles of category M_1 and N_1 ⁽¹⁾, equipped with compression-ignition engines,

covered by Article 1 of Directive 70/220/EEC in the version of Directive 83/351/EEC, with the exception of those vehicles of categories N_1 for which type-approval has been granted pursuant to Directive 88/77/EEC⁽²⁾.

▼ M9

At the request of the manufacturers, type-approval pursuant to this Directive may be extended from M_1 or N_1 vehicles equipped with compression ignition engines which have already been type-approved, to M_2 and N_2 vehicles having a reference mass not exceeding 2 840 kg and meeting the conditions of section 6 of this Annex (extension of EEC type-approval).

▼ M14

This Directive also applies to:

- the EC type-approval procedure for replacement catalytic converters as separate technical units intended to be fitted on vehicles of category M_1 and N_1 ,
- the EC type-approval procedure of automotive LPG or NG equipment as a separate technical unit intended to be fitted on vehicles of category M_1 and N_1 , with regard to its emissions.

▼ M9

2. DEFINITIONS

For the purposes of this Directive:

- 2.1. 'Vehicle type' with regard to the tailpipe emissions from the engine, means a category of power-driven vehicles which do not differ in such essential respects as:
 - 2.1.1. the equivalent inertia determined in relation to the reference mass as prescribed in section 5.1 of Annex III; and
 - 2.1.2. the engine and vehicle characteristics as defined in Annex II.
- 2.2. 'Reference mass' means the mass of the vehicle in running order less the uniform mass of the driver of 75 kg and increased by a uniform mass of 100 kg.
 - 2.2.1. 'Mass of the vehicle in running order' means the mass defined in section 2.6 of Annex I to Directive 70/156/EEC.
- 2.3. 'Maximum mass' means the mass defined in section 2.7 of Annex I to Directive 70/156/EEC.

⁽¹⁾ As defined in Part A of Annex II to Directive 70/156/EEC.

⁽²⁾ OJ L 36, 9.2.1998, p. 33.

▼ M14

- 2.4. 'Gaseous pollutants' means the exhaust gas emissions of carbon monoxide, oxides of nitrogen, expressed in nitrogen dioxide (NO_2) equivalent, and hydrocarbons assuming ratio of:
- $\text{C}_1\text{H}_{1.85}$ for petrol,
 - $\text{C}_1\text{H}_{1.86}$ for diesel,
 - $\text{C}_1\text{H}_{2.525}$ for LPG,
 - CH_4 for NG.

▼ M9

- 2.5. 'Particulate pollutants' means components of the exhaust gas which are removed from the diluted exhaust gas at a maximum temperature of 325 K (52 °C) by means of the filters described in Annex III.
- 2.6. 'Tailpipe emissions' means:
- for positive-ignition engines, the emission of gaseous pollutants,
 - for compression-ignition engines, the emission of gaseous and particulate pollutants.
- 2.7. 'Evaporative emissions' means the hydrocarbon vapours lost from the fuel system of a motor vehicle other than those from tailpipe emissions.
- 2.7.1. 'Tank breathing losses' are hydrocarbon emissions caused by temperature changes in the fuel tank (assuming a ratio of $\text{C}_1\text{H}_{2.33}$).
- 2.7.2. 'Hot soak losses' are hydrocarbon emissions arising from the fuel system of a stationary vehicle after a period of driving (assuming a ratio of $\text{C}_1\text{H}_{2.20}$).
- 2.8. 'Engine crankcase' means the spaces in, or external to, an engine which are connected to the oil sump by internal or external ducts through which gases and vapours can escape.
- 2.9. 'Cold start device' means a device which temporarily enriches the air/fuel mixture of the engine thus assisting the engine to start.
- 2.10. 'Starting aid' means a device which assists the engine to start without enrichment of the air/fuel mixture of the engine, e.g. glow plugs, modifications to the injection timing.
- 2.11. 'Engine capacity' means:
- 2.11.1. for reciprocating piston engines, the nominal engine swept volume,
 - 2.11.2. for rotary piston (Wankel) engines, double the nominal engine swept volume.
- 2.12. 'Anti-pollution device' means those components of a vehicle that control and/or limit tailpipe and evaporative emissions.

▼ M15

- 2.13. 'OBD' an on-board diagnostic system for emission control which has the capability of identifying the likely area of malfunction by means of fault codes stored in computer memory.
- 2.14. 'In-service test' means the test and evaluation of conformity conducted in accordance with section 7.1.7 of this Annex.
- 2.15. 'Properly maintained and used' means, for the purpose of a test vehicle, that such a vehicle satisfies the criteria for acceptance of a selected vehicle laid down in section 2 of Appendix 3 to this Annex.
- 2.16. 'Defeat device' means any element of design which senses temperature, vehicle speed, engine RPM, transmission gear, manifold vacuum or any other parameter for the purpose of activating, modulating, delaying or deactivating the operation of any part of the emission control system, that reduces the effectiveness of the emission control system under conditions which may reasonably be expected to be encountered in normal vehicle operation and use. Such an element of design may not be considered a defeat device if:
- I. the need for the device is justified in terms of protecting the engine against damage or accident and for safe operation of the vehicle, or
 - II. the device does not function beyond the requirements of engine starting, or

▼ M15

III. conditions are substantially included in the Type I or Type VI test procedures.

▼ M14

- 2.17. 'Original equipment catalytic converter' means a catalytic converter or an assembly of catalytic converters covered by the type-approval delivered for the vehicle and whose types are indicated in the document in Annex II to this Directive.
- 2.18. 'Replacement catalytic converter' means a catalytic converter or an assembly of catalytic converters for which approval can be obtained according to Annex XIII to this Directive, other than those defined in point 2.17.
- 2.19. 'Automotive LPG or NG equipment' means any assembly of automotive LPG or NG components designed to be fitted on one or more given types of motor vehicles, which can be approved as a separate technical unit.
- 2.20. 'Family of vehicles' means a group of vehicle types identified by a parent vehicle for the purpose of Annex XII.
- 2.21. 'Fuel requirement by the engine' means the type of fuel normally used by the engine:
- petrol,
 - LPG (liquefied petroleum gas),
 - NG (natural gas),
 - both petrol and LPG,
 - both petrol and NG,
 - diesel fuel.

▼ M15

3. APPLICATION FOR EC TYPE-APPROVAL
- 3.1. The application for EC type-approval pursuant to Article 3 (4) of Directive 70/156/EEC of a vehicle type with regard to its tailpipe emissions, evaporative emissions, durability of anti-pollution devices as well as to its on-board diagnostic (OBD) system must be submitted by the vehicle manufacturer.
- Should the application concern an on-board diagnostic (OBD) system the procedure described in Annex XI, section 3 must be followed.
- 3.1.1. Should the application concern an on-board diagnostic (OBD) system, it must be accompanied by the additional information required in section 3.2.12.2.8 of Annex II together with:
- 3.1.1.1. a declaration by the manufacturer of:
- 3.1.1.1.1. in the case of vehicles equipped with positive-ignition engines, the percentage of misfires out of a total number of firing events that would result in emissions exceeding the limits given in section 3.3.2 of Annex XI if that percentage of misfire had been present from the start of a type I test as described in section 5.3.1 of Annex III;
- 3.1.1.1.2. in the case of vehicles equipped with positive-ignition engines, the percentage of misfires out of a total number of firing events that could lead to an exhaust catalyst, or catalysts, overheating prior to causing irreversible damage;
- 3.1.1.2. detailed written information fully describing the functional operation characteristics of the OBD system, including a listing of all relevant parts of the vehicle's emission control system, i. e. sensors, actuators and components, that are monitored by the OBD system;
- 3.1.1.3. a description of the malfunction indicator (MI) used by the OBD system to signal the presence of a fault to a driver of the vehicle;
- 3.1.1.4. the manufacturer must describe provisions taken to prevent tampering with and modification of the emission control computer;
- 3.1.1.5. when appropriate, copies of other type-approvals with the relevant data to enable extensions of approvals;
- 3.1.1.6. if applicable, the particulars of the vehicle family as referred to in Annex XI, Appendix 2.

▼ M15

- 3.1.2. For the tests described in section 3 of Annex XI, a vehicle representative of the vehicle type or vehicle family fitted with the OBD system to be approved must be submitted to the technical service responsible for the type-approval test. If the technical service determines that the submitted vehicle does not fully represent the vehicle type or vehicle family described in Annex XI, Appendix 2, an alternative and if necessary an additional vehicle must be submitted for test in accordance with section 3 of Annex XI.
- 3.2. A model of the information document relating to tailpipe emissions, evaporative emissions, durability and the on-board diagnostic (OBD) system is given in Annex II.
- 3.2.1. Where appropriate, copies of other type-approvals with the relevant data to enable extension of approvals and establishment of deterioration factors must be submitted.

▼ M9

- 3.3. For the tests described in Section 5 of this Annex a vehicle representative of the vehicle type to be approved must be submitted to the technical service responsible for the type-approval tests.

▼ M15

4. GRANTING OF EC TYPE-APPROVAL
- 4.1. If the relevant requirements are satisfied, EC type-approval is granted pursuant to Article 4 (3) of Directive 70/156/EEC.
- 4.2. A model of the EC type-approval certificate relating to tailpipe emissions, evaporative emissions, durability and the on-board diagnostic (OBD) system is given in Annex X.

▼ M12

- 4.3. An approval number in accordance with Annex VII to Directive 70/156/EEC shall be assigned to each type of vehicle approved. The same Member State shall not assign the same number to another type of vehicle.

▼ M9

5. REQUIREMENTS AND TESTS

▼ M15

Note:

As an alternative to the requirements of this section, vehicle manufacturers whose world-wide annual production is less than 10 000 units may obtain EC type-approval on the basis of the corresponding technical requirements in:

— the California Code of Regulations, Title 13, Sections 1960.1 (f) (2) or (g) (1) and (g) (2), 1960.1 (p) applicable to 1996 and later model year vehicles, 1968.1, 1976 and 1975, applicable to 1995 and later model year light-duty vehicles, published by Barclay's Publishing.

The type-approval authority must inform the Commission of the circumstances of each approval granted under this provision.

▼ M9

- 5.1. **General**
- 5.1.1. The components liable to effect tailpipe and evaporative emissions must be so designed, constructed and assembled as to enable the vehicle, in normal use, to comply with the requirements of this Directive, despite the vibration to which they may be subjected.

▼ M15

The technical measures taken by the manufacturer must be such as to ensure that the tailpipe and evaporative emissions are effectively limited, pursuant to this Directive, throughout the normal life of the vehicle and under normal conditions of use. This will include the security of those hoses and their joints and connections, used within the emission control systems, which must be so constructed as to conform with the original design intent.

For tailpipe emissions, these provisions are deemed to be met if the provisions of sections 5.3.1.4 (type-approval) and section 7 (conformity of production and in-service vehicles) respectively are complied with.

▼ M15

For evaporative emissions, these provisions are deemed to be met if the provisions of section 5.3.4 (type-approval) and section 7 (conformity of production) are complied with.

The use of a defeat device is prohibited.

▼ M14

5.1.2. Inlet orifices of petrol tanks:

▼ M9

5.1.2.1. Subject to 5.1.2.2, the inlet orifice of the fuel tank must be so designed that it prevents the tank from being filled from a petrol pump delivery nozzle which has an external diameter of 23,6 mm or greater.

5.1.2.2. Section 5.1.2.1 does not apply to a vehicle in respect of which both of the following conditions are satisfied, that is to say:

5.1.2.2.1. that the vehicle is so designed and constructed that no device designed to control the emission of gaseous pollutants is adversely affected by leaded petrol, and

5.1.2.2.2. that the vehicle is conspicuously, legibly and indelibly marked with the symbol for unleaded petrol specified in ISO 2575-1982 in a position immediately visible to a person filling the fuel tank. Additional markings are permitted.

▼ M15

5.1.3. Provision must be made to prevent excess evaporative emissions and fuel spillage caused by a missing fuel filler cap. This may be achieved by using one of the following:

- an automatically opening and closing, non-removable fuel filler cap,
- design features which avoid excess evaporative emissions in the case of a missing fuel filler cap,
- any other provision which has the same effect. Examples may include, but are not limited to, a tethered filler cap, a chained filler cap or one utilizing the same locking key for the filler cap as for the vehicle's ignition. In this case the key must be removable from the filler cap only in the locked condition.

5.1.4. *Provisions for electronic system security*

5.1.4.1. Any vehicle with an emission control computer must include features to deter modification, except as authorised by the manufacturer. The manufacturer shall authorise modifications if these modifications are necessary for the diagnosis, servicing, inspection, retrofitting or repair of the vehicle. Any reprogrammable computer codes or operating parameters must be resistant to tampering and the computer and any related maintenance instructions must conform to the provisions in ISO DIS 15031-7. Any removable calibration memory chips must be potted, encased in a sealed container or protected by electronic algorithms and must not be changeable without the use of specialized tools and procedures.

5.1.4.2. Computer-coded engine operating parameters must not be changeable without the use of specialized tools and procedures (e. g. soldered or potted computer components or sealed (or soldered) computer enclosures).

5.1.4.3. In the case of mechanical fuel-injection pumps fitted to compression-ignition engines, manufacturers must take adequate steps to protect the maximum fuel delivery setting from tampering while a vehicle is in service.

5.1.4.4. Manufacturers may apply to the approval authority for an exemption to one of these requirements for those vehicles which are unlikely to require protection. The criteria that the approval authority will evaluate in considering an exemption will include, but are not limited to, the current availability of performance chips, the high-performance capability of the vehicle and the projected sales volume of the vehicle.

5.1.4.5. Manufacturers using programmable computer code systems (e. g. Electrical Erasable Programmable Read-Only Memory, EEPROM) must deter unauthorized reprogramming. Manufacturers must include enhanced tamperprotection strategies including data encryption using methods to secure the encryption algorithm and write protect features requiring electronic access to an off-site computer maintained by the manufacturer. Comparable

▼ M15

methods may be considered by the authority if they give the same level of protection.

▼ M95.2. **Application of tests**

Figure 1.5.2 illustrates the routes for type-approval of a vehicle.

▼ M15

- 5.2.1. Positive-ignition engined vehicles must be subject to the following tests:
- Type I (verifying the average tailpipe emissions after a cold start),
 - Type II (carbon monoxide emission at idling speed),
 - Type III (emission of crankcase gases),
 - Type IV (evaporation emissions),
 - Type V (durability of anti-pollution control devices),
 - Type VI (verifying the average low ambient temperature carbon monoxide and hydrocarbon tailpipe emissions after a cold start),
 - OBD-test.

▼ M10**▼ M14**

- 5.2.2. Positive-ignition engine powered vehicles fuelled with LPG or NG only shall be subjected to the following tests:
- type I (simulating the average tailpipe emissions after a cold start),
 - type II (carbon monoxide emissions at idling speed),
 - type III (emissions of crankcase),
 - type V (durability of pollution control devices).

▼ M15

- 5.2.3. Compression-ignition engined vehicles must be subject to the following tests:
- Type I (verifying the average tailpipe emissions after a cold start)
 - Type V (durability of anti-pollution control devices)
 - and, where applicable, OBD test.

▼ M10**▼ M9**5.3. **Description of tests**

- 5.3.1. Type I test (simulating the average tailpipe emissions after a cold start).
- 5.3.1.1. Figure I.5.3 illustrates the routes for type I test. This test must be carried out on all vehicles referred to in section 1, of a maximum mass not exceeding 3,5 tonnes.
- 5.3.1.2. The vehicle is placed on a chassis dynamometer equipped with a means of load and inertia simulation.
- **M10** 5.3.1.2.1. A test lasting a total of ◀ vehicles referred to in 8.1, a test lasting a total of 19 minutes and 40 seconds, made up of two parts, One and Two, is performed without interruption. An unsampled period of not more than 20 seconds may, with the agreement of the manufacturer, be introduced between the end of Part One and the beginning of Part Two in order to facilitate adjustment of the test equipment.

▼ M14

- 5.3.1.2.1.1. Vehicles that are fuelled with LPG or NG shall be tested in the type I test for variations in the composition of LPG or NG, as set out in Annex XII. Vehicles that can be fuelled either with petrol or with LPG or NG shall be tested in the type I test on both fuels, of which the fuelling on LPG or NG has to be performed for variation in the composition of LPG or NG, as set out in Annex XII.
- 5.3.1.2.1.2. Notwithstanding the requirement of point 5.3.1.2.1.1, vehicles that can be fuelled with both petrol and a gaseous fuel, but where

▼ **M14**

the petrol system is fitted for emergency purposes or starting only and of which the petrol tank cannot contain more than 15 litres of petrol will be regarded for the test type I as vehicles that can only run on a gaseous fuel.

▼ **M9**

- 5.3.1.2.2. Part One of the test is made up of four elementary urban cycles. Each elementary urban cycle comprises fifteen phases (idling, acceleration, steady speed, deceleration, etc.).
- 5.3.1.2.3. Part Two of the test is made up of one extra urban cycle. The extra urban cycle comprises 13 phases (idling, acceleration, steady speed, deceleration, etc.).

▼ **M15**

Figure I.5.2

Different routes for type-approval and extensions

| Type-approval test | Positive-ignition engined vehicles of categories M and N | Compression-ignition engined vehicles of categories M ₁ and N ₁ |
|----------------------|--|--|
| Type I | Yes (maximum mass ≤ 3,5 t) | Yes (maximum mass ≤ 3,5 t) |
| Type II | Yes | — |
| Type III | Yes | — |
| Type IV | Yes (maximum mass ≤ 3,5 t) | — |
| Type V | Yes (maximum mass ≤ 3,5 t) | Yes (maximum mass ≤ 3,5 t) |
| Type VI | Yes (vehicles in Category M ₁ and Category N ₁ , Class 1 ⁽¹⁾) | — |
| Extension | Section 6 | — Section 6 — M ₂ and N ₂ with reference mass not more than 2 840 kg ⁽²⁾ |
| On-board diagnostics | Yes in accordance with section 8.1 | Yes in accordance with section 8.2 and 8.3 |

⁽¹⁾ The Commission will as soon as possible, but not later than 31 December 1999, propose value limits for Classes II and III, in accordance with the procedure laid down in Article 13 of Directive 70/156/EEC. These value limits shall be applied no later than 2003.

⁽²⁾ The Commission will study further the question of extending the type-approval test to vehicles in Categories M₂ and N₂ with a reference mass not exceeding 2 840 kg and put forward proposals no later than 2004 in accordance with the procedure laid down in Article 13 of Directive 70/156/EEC, for measures to be applied in 2005.

▼ **M10**▼ **M9**

- 5.3.1.2.5. During the test the exhaust gases are diluted and a proportional sample collected in one or more bags. The exhaust gases of the vehicle tested are diluted, sampled and analyzed, following the procedure described below, and the total volume of the diluted exhaust is measured. Not only the carbon monoxide, hydrocarbon and nitrogen oxide emissions, but also the particulate pollutant emissions from vehicles equipped with compression-ignition engines are recorded.
- 5.3.1.3. The test is carried out using the procedure described in Annex III. The methods used to collect and analyse the gases and to remove and weigh the particulates must be as prescribed.
- 5.3.1.4. ► **M12** Subject to the requirements of 5.3.1.5 the test must be repeated three times. ◀ ► **M10** The results are multiplied by ◀ the appropriate deterioration factors obtained from 5.3.5. The resulting masses of gaseous emissions and, in the case of

▼ M9

vehicles equipped with compression-ignition engines, the mass of particulates obtained in each test must be less than the limits shown in the tables below:

| | | Limit values | | | | | | | | | |
|----------|------------------|--------------------------|------------------------------|-----------------------|---------------------------|-----------------------|---|-----------------------|--|-----------------------|---------------------------|
| Category | Class | Reference mass (RW) (kg) | Mass of carbon monoxide (CO) | | Mass of hydrocarbons (HC) | | Mass of oxides of nitrogen (NO _x) | | Combined mass of hydrocarbons and oxides of nitrogen (HC + NO _x) | | Mass of particulates (PM) |
| | | | L ₁ (g/km) | L ₂ (g/km) | L ₁ (g/km) | L ₂ (g/km) | L ₁ (g/km) | L ₂ (g/km) | L ₂ + L ₃ (g/km) | L ₄ (g/km) | |
| A (2000) | — | all | Petrol | 2,3 | 0,20 | 0,15 | 0,50 | — | 0,56 | 0,05 | |
| | | | Diesel | 0,64 | — | 0,15 | 0,50 | — | 0,56 | 0,05 | |
| | | | Diesel | 0,64 | — | 0,15 | 0,50 | — | 0,56 | 0,05 | |
| | I | RW ≤ 1305 | Petrol | 2,3 | 0,20 | 0,15 | 0,50 | — | 0,56 | 0,05 | |
| | | | Diesel | 0,64 | — | 0,15 | 0,50 | — | 0,56 | 0,05 | |
| | | | Diesel | 0,64 | — | 0,15 | 0,50 | — | 0,56 | 0,05 | |
| II | 1305 < RW ≤ 1760 | Petrol | 4,17 | 0,25 | 0,18 | 0,65 | — | 0,72 | 0,07 | | |
| | | Diesel | 0,80 | — | 0,18 | 0,65 | — | 0,72 | 0,07 | | |
| | | Diesel | 0,80 | — | 0,18 | 0,65 | — | 0,72 | 0,07 | | |
| III | 1760 < RW | Petrol | 5,22 | 0,29 | 0,21 | 0,78 | — | 0,86 | 0,10 | | |
| | | Diesel | 0,95 | — | 0,21 | 0,78 | — | 0,86 | 0,10 | | |
| | | Diesel | 0,95 | — | 0,21 | 0,78 | — | 0,86 | 0,10 | | |
| B (2005) | — | all | Petrol | 1,0 | 0,10 | 0,08 | 0,25 | — | 0,30 | 0,025 | |
| | | | Diesel | 0,50 | — | 0,08 | 0,25 | — | 0,30 | 0,025 | |
| | | | Diesel | 0,50 | — | 0,08 | 0,25 | — | 0,30 | 0,025 | |
| | I | RW ≤ 1305 | Petrol | 1,0 | 0,10 | 0,08 | 0,25 | — | 0,30 | 0,025 | |
| | | | Diesel | 0,50 | — | 0,08 | 0,25 | — | 0,30 | 0,025 | |
| | | | Diesel | 0,50 | — | 0,08 | 0,25 | — | 0,30 | 0,025 | |
| II | 1305 < RW ≤ 1760 | Petrol | 1,81 | 0,13 | 0,10 | 0,33 | — | 0,39 | 0,04 | | |
| | | Diesel | 0,63 | — | 0,10 | 0,33 | — | 0,39 | 0,04 | | |
| | | Diesel | 0,63 | — | 0,10 | 0,33 | — | 0,39 | 0,04 | | |
| III | 1760 < RW | Petrol | 2,27 | 0,16 | 0,11 | 0,39 | — | 0,46 | 0,06 | | |
| | | Diesel | 0,74 | — | 0,11 | 0,39 | — | 0,46 | 0,06 | | |
| | | Diesel | 0,74 | — | 0,11 | 0,39 | — | 0,46 | 0,06 | | |

(1) For compression ignition engines.

(2) Except vehicles the maximum mass of which exceeds 2 500 kg.

(3) And those Category M vehicles which are specified in note 2.

▼ **M13**

| Category/class of vehicle | | Limit values | | | | | |
|---------------------------|-------|------------------------------|--|--------|--|------------|---|
| | | Reference mass RW (kg) | Mass of carbon monoxide L_1 (g/km) | | Combined mass of hydrocarbons and oxides of nitrogen (g^2/km) | | Mass of particulates L_3 (g/km) |
| Category | Class | | Petrol | Diesel | Petrol | Diesel (1) | Diesel (1) |
| M (2) | — | all | 2,2 | 1,0 | 0,5 | 0,7 | 0,08 |
| N ₁ (3) | I | RW ≤ 1 250 | 2,2 | 1,0 | 0,5 | 0,7 | 0,08 |
| | II | 1 250 < RW ≤ 1 700 | 4,0 | 1,25 | 0,6 | 1,0 | 0,12 |
| | III | 1 700 < RW | 5,0 | 1,5 | 0,7 | 1,2 | 0,17 |

(1) Until 30 September 1999, for vehicles fitted with diesel engines of the direct injection type, the limit values L_2 and L_3 are the following:

| | L_2 | L_3 |
|--|-------|-------|
| — category M (2) and N ₁ (3) class I: | 0,9 | 0,10 |
| — category N ₁ (3) class II: | 1,3 | 0,14 |
| — category N ₁ (3) class III: | 1,6 | 0,20 |

(2) Except:

- vehicles designed to carry more than six occupants including the driver,
- vehicles whose maximum mass exceed 2 500 kg.

(3) And those category M vehicles which are specified in footnote (2).

▼ **M9**

- 5.3.1.4.1. Notwithstanding the requirements of 5.3.1.4, for each pollutant or combination of pollutants, one of the three resulting masses obtained may exceed, by not more than 10 %, the limit prescribed, provided the arithmetical mean of the three results is below the prescribed limit. Where the prescribed limits are exceeded for more than one pollutant it is immaterial whether this occurs in the same test or in different tests

► **M12** ◀

▼ **M12**▼ **M14**

- 5.3.1.4.2. When the tests are performed with gaseous fuels, the resulting mass of gaseous emissions shall be less than the limits for petrol-engined vehicles in the above table.

▼ **M9**

- 5.3.1.5. The number of tests prescribed in 5.3.1.4 is reduced in the conditions hereinafter defined, where V_1 is the result of the first test and V_2 the result of the second test for each pollutant or for the combined emission of two pollutants subject to limitation.
- 5.3.1.5.1. Only one test is performed if the result obtained for each pollutant or for the combined emission of two pollutants subject to limitation, is less than or equal to 0,70 L (ie. $V_1 \leq 0,70$ L).
- 5.3.1.5.2. If the requirement of 5.3.1.5.1 is not satisfied, only two tests are performed if, for each pollutant or for the combined emission of two pollutants subject to limitation, the following requirements are met:

$$V_1 \leq 0,85 \text{ L and } V_1 + V_2 \leq 1,70 \text{ L and } V_2 \leq L.$$

- 5.3.2. *Type II test (carbon monoxide emission test at idling speed)*

▼ **M10**

- 5.3.2.1. This test is carried out on vehicles powered by a positive-ignition engine to which the test specified in 5.3.1 does not apply.

▼ **M14**

- 5.3.2.1.1. Vehicles which can be fuelled either with petrol or with LPG or NG shall be tested in the test type II on both fuels.

▼ M14

- 5.3.2.1.2. Notwithstanding the requirement of point 5.3.2.1.1 above, vehicles that can be fuelled with both petrol and a gaseous fuel, but where the petrol system is fitted for emergency purposes or starting only and of which the petrol tank cannot contain more than 15 litres of petrol will be regarded for the type II test as vehicles that can only run on a gaseous fuel.

▼ M10

- 5.3.2.2. When tested in accordance with Annex IV, the carbon monoxide content by volume of the exhaust gases emitted with the engine idling must not exceed 3,5 % at the setting specified by the manufacturer and must not exceed 4,5 % within the range of adjustments specified in that Annex.

▼ M9

- 5.3.3. *Type III test (verifying emissions of crankcase gases)*
- 5.3.3.1. This test must be carried out on all vehicles referred to in section 1 except those having compression-ignition engines.

▼ M14

- 5.3.3.1.1. Vehicles that can be fuelled either with petrol or with LPG or NG should be tested in the type III test on petrol only.
- 5.3.3.1.2. Notwithstanding the requirement of point 5.3.3.1.1, vehicles that can be fuelled with both petrol and a gaseous fuel, but where the petrol system is fitted for emergency purposes or starting only and of which the petrol tank cannot contain more than 15 litres of petrol will be regarded for the type III test as vehicles that can only run on a gaseous fuel.

▼M12

Figure I.5.3

Flow chart for the type I type-approval

(see section 5.3.1)

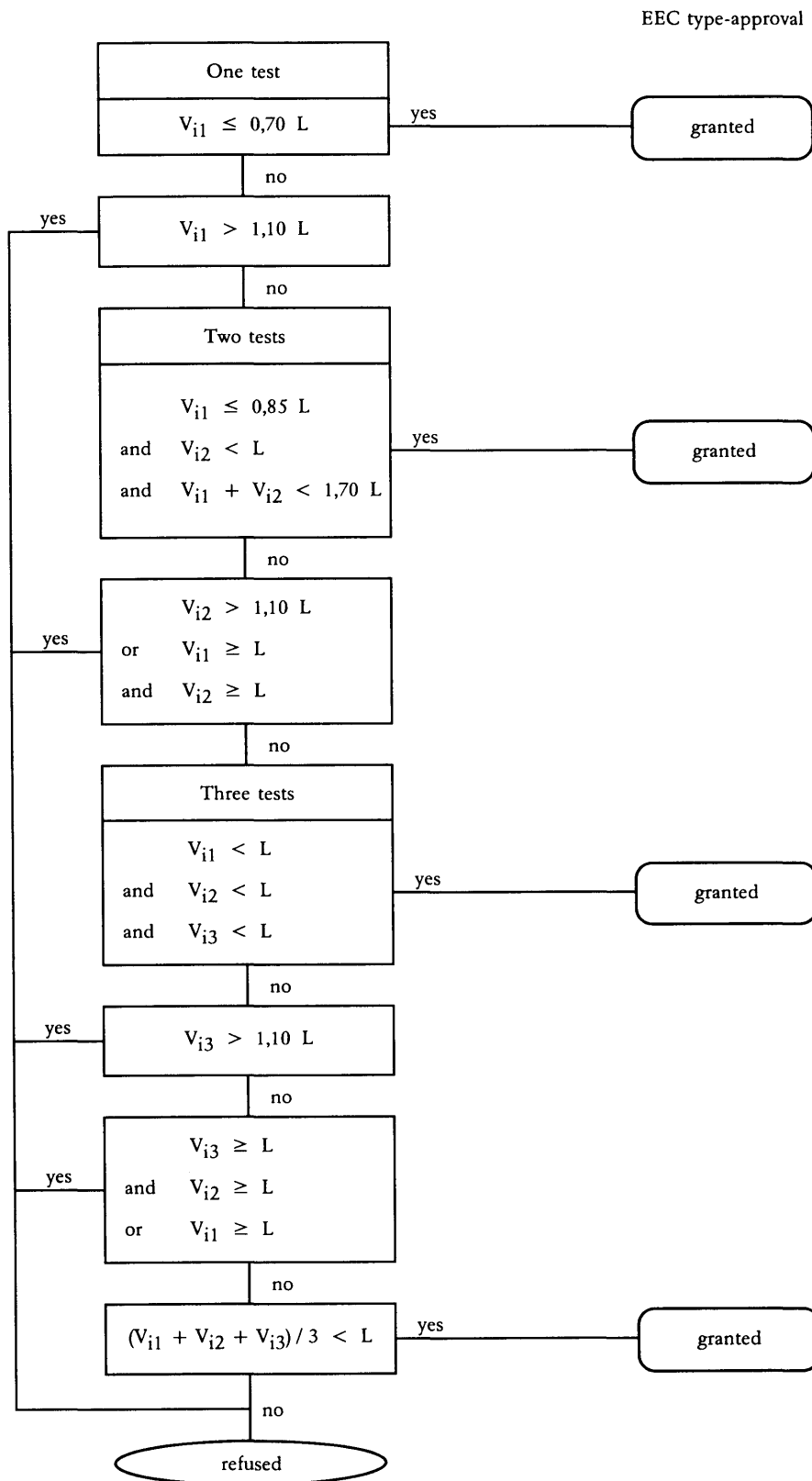

▼ M9

5.3.3.2. When tested in accordance with Annex V, the engine's crankcase ventilation system must not permit the emission of any of the crankcase gases into the atmosphere.

5.3.4. *Type IV test (determination of evaporative emissions)*

▼ M10

5.3.4.1. This test must be carried out on all vehicles referred to in Section 1 except those vehicles ► **M14** having a compression-ignition engine, and the vehicles fuelled with LPG or NG. ◀

▼ M14

5.3.4.1.1. Vehicles that can be fuelled either with petrol or with LPG or NG should be tested in the type IV test on petrol only.

▼ M9

5.3.4.2. When tested in accordance with Annex VI, evaporative emissions shall be less than 2 g/test.

▼ M15

5.3.5. (1) *Type VI test (verifying the average low ambient temperature carbon monoxide and hydrocarbon tailpipe emissions after a cold start)*

5.3.5.1. This test must be carried out on all M₁ and N₁ Class I⁽²⁾ vehicles equipped with a positive-ignition engine, except vehicles designed to carry more than six occupants and vehicles whose maximum mass exceeds 2 500 kg.

5.3.5.1.1. The vehicle is placed on a chassis dynamometer equipped with a means of load an inertia simulation.

5.3.5.1.2. The test consists of the four elementary urban driving cycles of part one of the Type I test. The Part One test is described in Annex III, Appendix 1 and illustrated in figures III.1.1 and III.1.2 of the Appendix. The low ambient temperature test lasting a total of 780 seconds must be carried out without interruption and start at engine cranking.

5.3.5.1.3. The low ambient temperature test must be carried out at an ambient test temperature of 266 °K (−7 °C). Before the test is carried out the test vehicles must be conditioned in a uniform manner to ensure that the test results may be reproducible. The conditioning and other test procedures are carried out as described in Annex VII.

5.3.5.1.4. During the test the exhaust gases are diluted and a proportional sample collected. The exhaust gases of the vehicle sampled are diluted, sampled and analysed, following the procedure described in Annex VII, and the total volume of the diluted exhaust is measured. The diluted exhaust gases are analysed for carbon monoxide and hydrocarbons.

5.3.5.2. Subject to the requirements in 5.3.5.2.2 and 5.3.5.3 the test must be performed three times. The resulting mass of carbon monoxide and hydrocarbon emission must be less than the limits shown in the table below:

| Test temperature | Carbon monoxide L ₁ (g/km) | Hydrocarbons L ₂ (g/km) |
|------------------|--|---------------------------------------|
| 266 °K (− 7 °C) | 15 | 1,8 |

5.3.5.2.1. Notwithstanding the requirements of 5.3.5.2, for each pollutant, not more than one of the three results obtained may exceed the limit prescribed by not more than 10 %, provided the arithmetical mean value of the three results is below the prescribed limit. Where the prescribed limits are exceeded for more than one pollutant it is immaterial whether this occurs in the same test or in different tests.

5.3.5.2.2. The number of tests prescribed in 5.3.5.2 may, at the request of the manufacturer, be increased to 10 provided that the arithme-

(1) This section is applicable to new types from 1 January 2002.

(2) The Commission will, as soon as possible, but not later than 31 December 1999, propose limit values for Classes II and III, in accordance with the procedure laid down in Article 13 of Directive 70/156/EEC. These limit values shall be applied no later than 2003.

▼ **M15**

tical mean of the first three results falls between 100 % to 110 % of the limit. In this case, the requirement after testing is only that the arithmetical mean of all 10 results must be less than the limit value.

- 5.3.5.3. The number of tests prescribed in 5.3.5.2 may be reduced according to 5.3.5.3.1 and 5.3.5.3.2.
- 5.3.5.3.1. Only one test is performed if the result obtained for each pollutant of the first test is less than or equal to 0,70 L.
- 5.3.5.3.2. If the requirement of 5.3.5.3.1 is not satisfied, only two tests are performed if for each pollutant the result of the first test is less than or equal to 0,85 L and the sum of the first two results is less than or equal to 1,70 L and the result of the second test is less than or equal to L.

($V_1 \leq 0,85$ L and $V_1 + V_2 \leq 1,70$ L and $V_2 \leq L$).

▼ **M9**

► **M15** 5.3.6. ◀ *Type V test (durability of anti-pollution devices)*

► **M10** ► **M15** 5.3.6.1. ◀ This test must be carried out on all vehicles referred to in Section 1 to which the test specified in 5.3.1 applies' (remainder unchanged). ◀ The test represents an ageing test of 80 000 kilometres driven in accordance with the programme described in Annex VII on a test track, on the road or on a chassis dynamometer.

▼ **M14**

► **M15** 5.3.6.1.1. ◀ Vehicles that can be fuelled either with petrol or with LPG or NG should be tested in the type V test on petrol only.

▼ **M9**

► **M15** 5.3.6.2. ◀ Notwithstanding the requirement of ► **M15** 5.3.6.1 ◀ a manufacturer may choose to have the deterioration factors from the following table used as an alternative to testing to ► **M15** 5.3.6.1.1 ◀.

▼ **M15**

| Engine Category | Deterioration factors | | | | |
|------------------------------|-----------------------|-----|-----------------|-------------------------------------|--------------|
| | CO | HC | NO _x | HC + NO _x ⁽¹⁾ | Particulates |
| Positive-ignition engines | 1,2 | 1,2 | 1,2 | — | — |
| Compression-ignition engines | 1,1 | — | 1,0 | 1,0 | 1,2 |

⁽¹⁾ For compression-ignition engines.

▼ **M9**

At the request of the manufacturer, the technical service may carry out the type I test before the type V test has been completed using the deterioration factors in the table above. On completion of the type V test, the technical service may then amend the type-approval results recorded in Annex IX by replacing the deterioration factors in the above table with those measured in the type V test.

▼ **M15**

5.3.6.3. Deterioration factors are determined using either the procedure in 5.3.6.1 or using the values in the table in 5.3.6.2. The deterioration factors are used to establish compliance with the requirements of 5.3.1.4.

5.3.7. *Emissions data required for roadworthiness testing*

5.3.7.1. This requirement applies to all vehicles powered by a positive-ignition engine for which EC type-approval is sought in accordance with this Directive.

5.3.7.2. When tested in accordance with Annex IV (type II test) at normal idling speed:
— the carbon monoxide content by volume of the exhaust gases emitted must be recorded,

▼ **M15**

- the engine speed during the test must be recorded, including any tolerances.
- 5.3.7.3. When tested at 'high idle' speed (i. e. > 2 000 min⁻¹):
 - the carbon monoxide content by volume of the exhaust gases emitted must be recorded,
 - the Lambda value (1) must be recorded.
 - the engine speed during the test must be recorded, including any tolerances.
- 5.3.7.4. The engine oil temperature at the time of the test must be measured and recorded.
- 5.3.7.5. The table in section 1.9 of the Appendix to Annex X must be completed.
- 5.3.7.6. The manufacturer must confirm the accuracy of the Lambda value recorded at the time of type-approval in section 5.3.7.3 as being representative of typical production vehicles within 24 months of the date of the granting of type-approval by the technical service. An assessment must be made on the basis of surveys and studies of production vehicles.

▼ **M14**

- 5.3.8. *Approval of a replacement catalytic converter*
- 5.3.8.1. The test must be carried out only for replacement catalytic converter intended to be fitted on EC type-approved vehicles which are not equipped with on OBD, according to Annex XIII.

▼ **M12**

6. MODIFICATIONS OF THE TYPE AND AMENDMENTS TO APPROVALS

In the case of modifications of the type approved pursuant to this Directive, the provisions of Article 5 of Directive 70/156/EEC and, if applicable, the following special provisions shall apply:

▼ **M15**

- 6.1. **Tailpipe emission related extension (type I, type II and type VI tests)**

▼ **M10**

- 6.1.1. *Vehicle types of different reference masses*

▼ **M12**

- 6.1.1.1. Approval granted to a vehicle type may be extended only to vehicle types of a reference mass requiring the use of the next two higher equivalent inertia or any lower equivalent inertia.

▼ **M10**

- 6.1.1.2. In the case of vehicles of category N₁ and vehicles of category M referred to in note 2 of Section 5.3.1.4, if the reference mass of the vehicle type for which extension of the approval is requested requires the use of a flywheel of equivalent inertia lower than that used for the vehicle type already approved, extension of the approval is granted if the masses of the pollutants obtained from the vehicle already approved are within the limits prescribed for the vehicle for which extension of the approval is requested

(1) The Lambda value must be calculated using the simplified Bretschneider equation as follows:

$$\lambda = \frac{[\text{CO}_2] + \left[\frac{[\text{CO}]}{2} \right] + [\text{O}_2] + \left(\frac{\text{Hcv}}{4} \times \frac{3,5}{3,5 + \frac{[\text{CO}]}{[\text{CO}_2]}} - \frac{\text{Ocv}}{2} \right) \times ([\text{CO}_2] + [\text{CO}])}{\left(1 + \frac{\text{Hcv}}{4} - \frac{\text{Ocv}}{2} \right) \times ([\text{CO}_2] + [\text{CO}] + \text{K1} \times [\text{HC}])}$$

Where:

[] = Concentration in % vol.

K1 = Conversion factor for NDIR measurement to FID measurement (provided by manufacturer of measurement equipment)

Hcv = Atomic ratio of hydrogen to carbon [1,7261]

Ocv = Atomic ratio of oxygen to carbon [0,0175].

▼ **M9**6.1.2. *Vehicle types with different overall gear ratios*

Approval granted to a vehicle type may under the following conditions be extended to vehicle types which differ from the type approved only in respect of their transmission ratios:

- 6.1.2.1. ► **M15** For each of the transmission ratios used in the type I and type VI tests, ◀ it is necessary to determine the proportion,

$$E = \frac{V_2 - V_1}{V_1}$$

where, at an engine speed of 1 000 rpm, V_1 is the speed of the vehicle-type approved and V_2 is the speed of the vehicle type for which extension of the approval is requested.

- **M15** 6.1.2.2. If, for each gear ratio, $E \leq 8 \%$, the extension is granted without repeating the type I and type VI tests.

- 6.1.2.3. If, for at least one gear ratio, $E \leq 8 \%$, and if, for each gear ratio, $E \leq 13 \%$, the type I and type VI tests must be repeated, ◀ but may be performed in a laboratory chosen by the manufacturer ► **M12** subject to the approval of the technical service. ◀ The report of the tests must be sent to the technical service responsible for the type-approval tests.

6.1.3. *Vehicle types of different reference masses and different overall transmission ratios*

Approval granted to a vehicle type may be extended to vehicle types differing from the approved type only in respect of their reference mass and their overall transmission ratios, provided that all the conditions prescribed in 6.1.1 and 6.1.2 are fulfilled.

6.1.4. *Note:*

When a vehicle type has been approved in accordance with 6.1.1 to 6.1.3, such approval may not be extended to other vehicle types.

6.2. **Evaporative emissions (type IV test)**

- 6.2.1. Approval granted to a vehicle type equipped with a control system for evaporative emissions may be extended under the following conditions:

- 6.2.1.1. The basic principle of fuel/air metering (e.g. single point injection, carburettor) must be the same.

- 6.2.1.2. The shape of the fuel tank and the material of the fuel tank and liquid fuel hoses must be identical. The worst-case family with regard to the cross-section and approximate hose length must be tested. Whether non-identical vapour/liquid separators are acceptable is decided by the technical service responsible for the type-approval tests. The fuel tank volume must be within a range of $\pm 10 \%$. The setting of the tank relief valve must be identical.

- 6.2.1.3. The method of storage of the fuel vapour must be identical, i.e. trap form and volume, storage medium, air cleaner (if used for evaporative emission control), etc.

- 6.2.1.4. The carburettor bowl fuel volume must be within a 10 millilitre range.

- 6.2.1.5. The method of purging of the stored vapour must be identical (e.g. air flow, start point or purge volume over driving cycle).

- 6.2.1.6. The method of sealing and venting of the fuel metering system must be identical.

6.2.2. Further notes:

- (i) different engine sizes are allowed;
- (ii) different engine powers are allowed;
- (iii) automatic and manual gearboxes, two and four wheel transmissions are allowed;
- (iv) different body styles are allowed;
- (v) different wheel and tyre sizes are allowed.

6.3. **Durability of anti-pollution devices**
(type V test)

▼ M9

6.3.1. Approval granted to a vehicle type may be extended to different vehicle types, provided that the engine/pollution control system combination is identical to that of the vehicle already approved. To this end, those vehicle types whose parameters described below are identical or remain within the limit values prescribed are considered to belong to the same engine/pollution control system combination.

6.3.1.1. Engine:

- number of cylinders,
- engine capacity ($\pm 15\%$),
- configuration of the cylinder block,
- number of valves,
- fuel system,
- type of cooling system,
- combustion process,

▼ M12

- cylinder bore centre to centre dimensions.

▼ M9

6.3.1.2. Pollution control system:

- Catalytic converters:
 - number of catalytic converters and elements,

▼ M12

- size and shape of catalytic converters (volume of monolith $\pm 10\%$),

▼ M9

- type of catalytic activity (oxidizing, three-way, ...),
- precious metal load (identical or higher),
- precious metal ratio ($\pm 15\%$),
- substrate (structure and material),
- cell density,
- type of casing for the catalytic converter(s),
- location of catalytic converters (position and dimension in the exhaust system, that does not produce a temperature variation of more than 50 K at the inlet of the catalytic converter). ► **M12** This temperature variation shall be checked under stabilized conditions at a speed of 120 km/h and the load setting of type I test. ◀
- Air injection:
 - with or without
 - type (pulsair, air pumps, ...).
- EGR:
 - with or without.

▼ M12

6.3.1.3. Inertia category: the two inertia categories immediately above and any inertia category below.

▼ M9

6.3.1.4. The durability test may be achieved by using a vehicle, the body style, gear box (automatic or manual) and size of the wheels or tyres of which are different from those of the vehicle type for which the type approval is sought.

▼ M15

6.4. On-board diagnostics

6.4.1. Approval granted to a vehicle type with respect to the OBD system may be extended to different vehicle types belonging to the same vehicle-OBD family as described in Annex XI, Appendix 2. The engine emission control system must be identical to that of the vehicle already approved and comply with the description of the OBD engine family given in Annex XI, Appendix 2, regardless of the following vehicle characteristics:

- engine accessories,
- tyres,
- equivalent inertia,
- cooling system,
- overall gear ratio,
- transmission type,

▼ **M15**

— type of bodywork.

▼ **M11**

7. CONFORMITY OF PRODUCTION

▼ **M15**

7.1. Measures to ensure the conformity of production must be taken in accordance with the provisions of Article 10 of Directive 70/156/EEC, as last amended by Directive 96/27/EEC (whole vehicle type-approval). That Article entrusts the manufacturer with the responsibility for taking measures to ensure the conformity of production to the type approved. Conformity of production is checked on the basis of the description in the type-approval certificate set out in Annex X to this Directive.

As a general rule, conformity of production with regard to limitation of tailpipe and evaporative emissions from the vehicle is checked on the basis of the description in the type-approval certificate set out in Annex X and, where necessary, of all or some of the tests of types I, II, III and IV described in section 5.2.

Conformity of in-service vehicles

With reference to type-approvals granted for emissions, these measures must also be appropriate for confirming the functionality of the emission control devices during the normal useful life of the vehicles under normal conditions of use (conformity of in-service vehicles properly maintained and used). For the purpose of this Directive these measures must be checked for a period of up to 5 years of age or 80 000 km, whichever is the sooner, and from 1 January 2005, for a period of up to five years of age or 100 000 km, whichever is the sooner.

7.1.1. Audit of in-service conformity by the type-approval authority is conducted on the basis of any relevant information that the manufacturer has, under procedures similar to those defined in Article 10 (1) and (2), and in Annex 10 (1) and (2) of Directive 70/156/EEC.

An audit of in-service conformity will be conducted by the type-approval authority on the basis of information supplied by the manufacturer. Such information must include:

- relevant surveillance test data obtained in accordance with applicable requirements and test procedures, together with full information for each tested vehicle such as vehicle status, use history, service conditions and other relevant factors;
- relevant information on service and repair measures,
- other relevant tests and observations recorded by the manufacturer, including especially records of indications from the OBD system.⁽¹⁾

7.1.2. The information gathered by the manufacturer must be sufficiently comprehensive to ensure that in-service performance can be assessed for normal conditions of use as defined in 7.1, and in a way representative of the manufacturer's geographic market penetration.

▼ **M12**

► **M15** 7.1.3. ◀ If a type I test is to be carried out and a vehicle type-approval has one or several extensions, the tests will be carried out either on the vehicle described in the initial information package or on the vehicle described in the information package relating to the relevant extension.

▼ **M11**

► **M15** 7.1.3.1. ◀ *Checking the conformity of the vehicle for a type I test.*

After selection by the authority, the manufacturer must not undertake any adjustment to the vehicles selected.

► **M15** 7.1.3.1.1. ◀ Three vehicles are selected at random in the series and are tested as described in Section 5.3.1 of this Annex. The dete-

⁽¹⁾ Sections 7.1.1 and 7.1.2 will be re-examined and completed without delay in accordance with the procedure laid down in Article 13 of Directive 70/156/EEC while taking into account the particular problems associated with vehicles in Category N₁ and with the vehicles in Category M referred to in footnote 2 to the table in section 5.3.1.4. Proposals must be submitted in good time for their adoption before the dates laid down in Article 2(3).

▼ **M11**

rioration factors are used in the same way. The limit values are given in Section 5.3.1.4 of this Annex.

- **M15** 7.1.3.1.2. ◀ If the authority is satisfied with the production standard deviation given by the manufacturer in accordance with Annex X to Directive 70/156/EEC, the tests are carried out according to Appendix 1 of this Annex.

If the authority is not satisfied with the production standard deviation given by the manufacturer in accordance with Annex X to Directive 70/156/EEC, the tests are carried out according to Appendix 2 of this Annex.

- **M15** 7.1.3.1.3. ◀ The production of a series is deemed to conform or not to conform on the basis of a sampling test of the vehicles once a pass decision is reached for all the pollutants or a fail decision is reached for one pollutant, according to the test criteria applied in the appropriate appendix.

When a pass decision has been reached for one pollutant, that decision will not be changed by any additional tests carried out to reach a decision for the other pollutants.

If no pass decision is reached for all the pollutants and no fail decision is reached for one pollutant, a test is carried out on another vehicle (see Figure I/7).

- **M15** 7.1.3.2. ◀ Notwithstanding the requirements of Section 3.1.1 of Annex III, the tests will be carried out on vehicles coming straight off the production line.

- **M15** 7.1.3.2.1. ◀ However, at the request of the manufacturer, the tests may be carried out on vehicles which have completed:

- a maximum of 3 000 km for vehicles equipped with a positive ignition engine,
- a maximum of 15 000 km for vehicles equipped with a compression ignition engine,

In both these cases, the running-in procedure will be conducted by the manufacturer, who must undertake not to make any adjustments to these vehicles.

▼M11

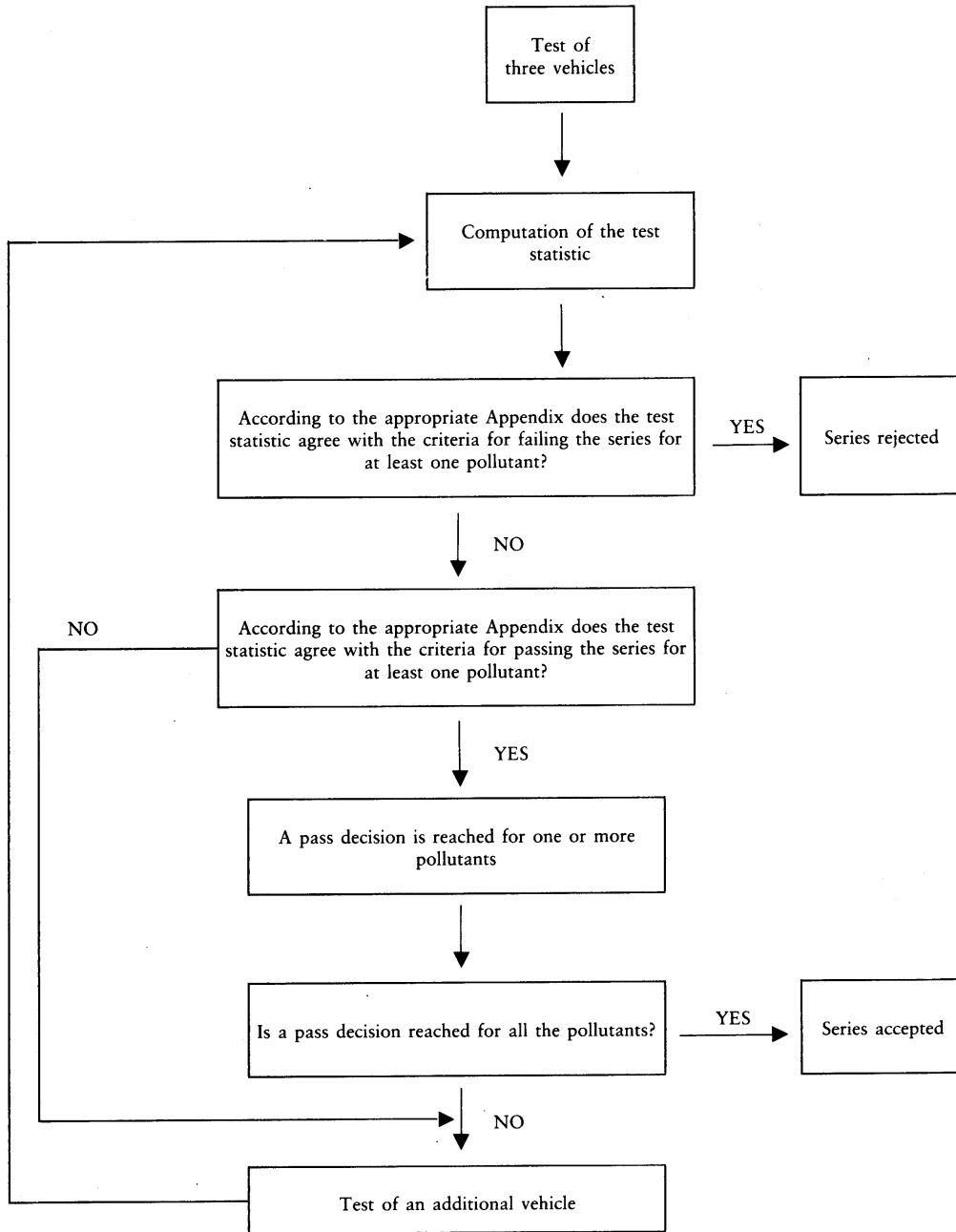

Figure I.7

▼ **M11**

► **M15** 7.1.3.2.2. ◀ If the manufacturer wishes to run in the vehicles, ('x' km, where $x \leq 3\,000$ km for vehicles equipped with a positive ignition engine and $x \leq 15\,000$ km for vehicles equipped with a compression ignition engine), the procedure will be as follows:

- the pollutant emissions (type I) will be measured at zero and at 'x' km on the first tested vehicle,
- the evolution coefficient of the emissions between zero and 'x' km will be calculated for each of the pollutants:

$$\frac{\text{Emissions 'x' km}}{\text{Emissions zero km}}$$

This may be less than 1,

- the other vehicles will not be run in, but their zero km emissions will be multiplied by the evolution coefficient.

In this case, the values to be taken will be:

- the values at 'x' km for the first vehicle,
- the values at zero km multiplied by the evolution coefficient for the other vehicles.

► **M15** 7.1.3.2.3. ◀ All these tests may be conducted with commercial fuel. However, at the manufacturer's request, the reference fuels described in Annex VIII may be used.

► **M15** 7.1.4. ◀ If a type III test is to be carried out, it must be conducted on all vehicles selected for the type I COP test (7.1.1.1.1). The conditions laid down in 5.3.3.2 must be complied with.

► **M15** 7.1.5. ◀ If a type IV test is to be carried out, it must be conducted in accordance with Section 7 of Annex VI.

▼ **M15***On-board Diagnostics (OBD)*

7.1.6. If a verification of the performance of the OBD system is to be carried out, it must be conducted in accordance with the following:

7.1.6.1. When the approval authority determines that the quality of production seems unsatisfactory a vehicle is randomly taken from the series and subjected to the tests described in Annex XI, Appendix 1.

7.1.6.2. The production is deemed to conform if this vehicle meets the requirements of the tests described in Annex XI, Appendix 1.

7.1.6.3. If the vehicle taken from the series does not satisfy the requirements of section 7.1.6.1 a further random sample of four vehicles must be taken from the series and subjected to the tests described in Annex XI, Appendix 1. The tests may be carried out on vehicles which have been run in for no more than 15 000 km.

7.1.6.4. The production is deemed to conform if at least 3 vehicles meet the requirements of the tests described in Annex XI, Appendix 1.

7.1.7. On the basis of the audit referred to in 7.1.1, the type-approval authority must either:

- decide that conformity in use is satisfactory and not take any further action, or
- decide that the information is insufficient or the conformity of vehicles in use is unsatisfactory, and proceed to have vehicles tested in accordance with Appendix 3 to this Annex.

7.1.7.1. Where type I tests are considered necessary to check the conformity of emission control devices with the requirements for their performance while in service, such tests must be carried out using a test procedure meeting the statistical criteria defined in Appendix 4 to this Annex.

7.1.7.2. The type-approval authority, in cooperation with the manufacturer, must select a sample of vehicles with sufficient mileage whose use under normal conditions can be reasonably assured. The manufacturer must be consulted on the choice of the vehicles in the sample and be allowed to attend the confirmatory checks of the vehicles.

7.1.7.3. The manufacturer is authorized, under the supervision of the type-approval authority, to carry out checks, even of a destructive

▼ **M15**

nature, on those vehicles with emission levels in excess of the limit values with a view to establishing possible causes of deterioration which cannot be attributed to the manufacturer himself (e. g. use of leaded petrol before the test date). Where the results of the checks confirm such causes, those test results are excluded from the conformity check.

- 7.1.7.4. Where the type-approval authority is not satisfied with the results of the tests in accordance with the criteria defined in Appendix 4, the remedial measures referred to in Article 11 (2) and in Annex X to Directive 70/156/EEC are extended to vehicles in service belonging to the same vehicle type which are likely to be affected with the same defects in accordance with section 6 of Appendix 3.

The plan of remedial measures presented by the manufacturer must be approved by the type-approval authority. The manufacturer is responsible for the execution of the remedial plan as approved.

The type-approval authority must notify its decision to all Member States within 30 days. The Member States may require the same plan of remedial measures be applied to all vehicles of the same type registered in their territory.

- 7.1.7.5. If a Member State has established that a vehicle type does not conform to the applicable requirements of Appendix 3 to this Annex, it must notify without delay the Member State which granted the original type-approval in accordance with the requirements of Article 11 (3) of Directive 70/156/EEC.

Then, subject to the provision of Article 11(6) of Directive 70/156/EEC, the competent authority of the Member State which granted the original type-approval shall inform the manufacturer that a vehicle type fails to satisfy the requirements of these provisions and that certain measures are expected of the manufacturer. The manufacturer shall submit to the authority, within two months after this notification, a plan of measures to overcome the defects, the substance of which should correspond to the requirements of sections 6.1 to 6.8 of Appendix 3. The competent authority which granted the original type-approval shall, within two months, consult the manufacturer in order to secure agreement on a plan of measures and on carrying out the plan. If the competent authority which granted the original type-approval establishes that no agreement can be reached, the procedure pursuant to Article 11(3) and (4) of Directive 70/156/EEC shall be initiated.

8. ON-BOARD DIAGNOSTIC (OBD) SYSTEM FOR MOTOR VEHICLES

- 8.1. Vehicles of Category M_1 and N_1 equipped with positive-ignition engines must be fitted with an onboard diagnostic (OBD) system for emission control in accordance with Annex XI.

- 8.2. Vehicles of category M_1 equipped with compression-ignition engines, except

- vehicles designed to carry more than six occupants including the driver,
- vehicles whose maximum mass exceeds 2 500 kg,

from 1 January 2003 for new types and from 1 January 2004 for all types, must be fitted with an on-board diagnostic (OBD) system for emission control in accordance with Annex XI.

Where new types of compression-ignition engined vehicles entering into service prior to this date are fitted with an OBD system, the provisions of sections 6.5.3 to 6.5.3.5 of Annex XI, Appendix 1, are applicable.

- 8.3. New types of Category M_1 exempted by section 8.2, and new types of vehicles in Category N_1 class I equipped with compression-ignition engines, must, from 1 January 2005, be fitted with an on-board diagnostic (OBD) system for emission control in accordance with Annex XI. New types of vehicles in Category N_1 Classes II and III equipped with compression-ignition engines must, from 1 January 2006, be fitted with on-board diagnostic

▼M15

(OBD) systems for emission control in accordance with Annex XI.

Where compression-ignition engines entering into service prior to the dates given in this section are fitted with OBD systems, the provisions of sections 6.5.3 to 6.5.3.5 of Annex XI, Appendix 1, are applicable.

8.4. Vehicles of other Categories

Vehicles of other Categories or vehicles of Category M₁ and N₁ not covered by 8.1, 8.2 or 8.3, may be fitted with an on-board diagnostic system. In this case, sections 6.5.3 to 6.5.3.5 of Annex XI, Appendix 1, are applicable.

▼ **M11***Appendix 1*

1. This Appendix describes the procedure to be used to verify the production conformity for the type I test when the manufacturer's production standard deviation is satisfactory.
2. With a minimum sample size of 3, the sampling procedure is set so that the probability of a lot passing a test with 40 % of the production defective is 0,95 (producer's risk = 5 %) while the probability of a lot being accepted with 65 % of the production defective is 0,1 (consumer's risk = 10 %).
3. For each of the pollutants given in Section 5.3.1.4 of Annex I, the following procedure is used (see Figure I.7).

Taking:

- L = the natural logarithm of the limit value for the pollutant,
 x_i = the natural logarithm of the measurement for the i-th vehicle of the sample,
s = an estimate of the production standard deviation (after taking the natural logarithm of the measurements),
n = the current sample number.

4. Compute for the sample the test statistic quantifying the sum of the standard deviations from the limit and defined as:

$$\frac{1}{s} \sum_{i=1}^n (L - x_i)$$

5. Then:

- if the test statistic is greater than the pass decision number for the sample size given in Table (I.1.5), the pollutant is passed,
- if the test statistic is less than the fail decision number for the sample size given in Table (I.1.5), the pollutant is failed; otherwise, an additional vehicle is tested according to Section 7.1.1.1 of Annex I and the calculation reapplied to the sample with a sample size one unit greater.

TABLE I.1.5

| Cumulative number of tested vehicles (current sample size) | Pass decision threshold | Fail decision threshold |
|---|-------------------------|-------------------------|
| 3 | 3,327 | -4,724 |
| 4 | 3,261 | -4,790 |
| 5 | 3,195 | -4,856 |
| 6 | 3,129 | -4,922 |
| 7 | 3,063 | -4,988 |
| 8 | 2,997 | -5,054 |
| 9 | 2,931 | -5,120 |
| 10 | 2,865 | -5,185 |
| 11 | 2,799 | -5,251 |
| 12 | 2,733 | -5,317 |
| 13 | 2,667 | -5,383 |
| 14 | 2,601 | -5,449 |
| 15 | 2,535 | -5,515 |
| 16 | 2,469 | -5,581 |
| 17 | 2,403 | -5,647 |
| 18 | 2,337 | -5,713 |
| 19 | 2,271 | -5,779 |
| 20 | 2,205 | -5,845 |
| 21 | 2,139 | -5,911 |
| 22 | 2,073 | -5,977 |
| 23 | 2,007 | -6,043 |
| 24 | 1,941 | -6,109 |
| 25 | 1,875 | -6,175 |
| 26 | 1,809 | -6,241 |
| 27 | 1,743 | -6,307 |
| 28 | 1,677 | -6,373 |
| 29 | 1,611 | -6,439 |
| 30 | 1,545 | -6,505 |
| 31 | 1,479 | -6,571 |
| 32 | -2,112 | -2,112 |

▼ **M11***Appendix 2*

1. This Appendix describes the procedure to be used to verify the production conformity requirements for the type I test when the manufacturer's evidence of production standard deviation is either unsatisfactory or unavailable.
2. With a minimum sample size of 3, the sampling procedure is set so that the probability of a lot passing a test with 40 % of the production defective is 0,95 (producer's risk = 5 %) while the probability of a lot being accepted with 65 % of the production defective is 0,1 (consumer's risk = 10 %).
3. The measurements of the pollutants given in Section 5.3.1.4 of Annex I are considered to be log normally distributed and must first be transformed by taking their natural logarithms. Let m_0 and m denote the minimum and maximum sample sizes respectively ($m_0 = 3$ and $m = 32$) and let n denote the current sample number.
4. If the natural logarithms of the measurements in the series are x_1, x_2, \dots, x_j and L is the natural logarithm of the limit value for the pollutant, then define:

$$d_j = x_j - L$$

$$\bar{d}_n = \frac{1}{n} \sum_{j=1}^n d_j$$

$$v_n^2 = \frac{1}{n} \sum_{j=1}^n (d_j - \bar{d}_n)^2$$

5. Table I.2.5 shows values of the pass (A_n) and fail (B_n) decision numbers against current sample number. The test statistic is the ratio \bar{d}_n/v_n and must be used to determine whether the series has passed or failed as follows:

For $m_0 \leq n \leq m$:

- pass the series if $\bar{d}_n/v_n \leq A_n$,
- fail the series if $\bar{d}_n/v_n \geq B_n$,
- take another measurement if $A_n < \bar{d}_n/v_n < B_n$.

6. *Remarks*

The following recursive formulae are useful for computing successive values of the test statistic:

$$\bar{d}_n = \left(1 - \frac{1}{n}\right) \bar{d}_{n-1} + \frac{1}{n} d_n$$

$$v_n^2 = \left(1 - \frac{1}{n}\right) v_{n-1}^2 + \frac{(\bar{d}_n - d_n)^2}{n-1}$$

$$(n = 2, 3, \dots; \bar{d}_1 = d_1; v_1 = 0)$$

▼ **M11**

TABLE I.2.5
Minimum sample size = 3

| Sample size n | Pass decision threshold A_n | Fail decision threshold B_n |
|------------------|----------------------------------|----------------------------------|
| 3 | -0,80381 | 16,64743 |
| 4 | -0,76339 | 7,68627 |
| 5 | -0,72982 | 4,67136 |
| 6 | -0,69962 | 3,25573 |
| 7 | -0,67129 | 2,45431 |
| 8 | -0,64406 | 1,94369 |
| 9 | -0,61750 | 1,59105 |
| 10 | -0,59135 | 1,33295 |
| 11 | -0,56542 | 1,13566 |
| 12 | -0,53960 | 0,97970 |
| 13 | -0,51379 | 0,85307 |
| 14 | -0,48791 | 0,74801 |
| 15 | -0,46191 | 0,65928 |
| 16 | -0,43573 | 0,58321 |
| 17 | -0,40933 | 0,51718 |
| 18 | -0,38266 | 0,45922 |
| 19 | -0,35570 | 0,40788 |
| 20 | -0,32840 | 0,36203 |
| 21 | -0,30072 | 0,32078 |
| 22 | -0,27263 | 0,28343 |
| 23 | -0,24410 | 0,24943 |
| 24 | -0,21509 | 0,21831 |
| 25 | -0,18557 | 0,18970 |
| 26 | -0,15550 | 0,16328 |
| 27 | -0,12483 | 0,13880 |
| 28 | -0,09354 | 0,11603 |
| 29 | -0,06159 | 0,09480 |
| 30 | -0,02892 | 0,07493 |
| 31 | 0,00449 | 0,05629 |
| 32 | 0,03876 | 0,03876 |

▼ **M15***Appendix 3***IN-SERVICE CONFORMITY CHECK****1. INTRODUCTION**

This Appendix sets out the criteria referred to in section 7.1.7 of this Annex regarding the selection of vehicles for testing and the procedures for the in-service conformity control.

2. SELECTION CRITERIA

The criteria for acceptance of a selected vehicle are defined in sections 2.1 to 2.8 of this Appendix. Information is collected by vehicle examination and an interview with the owner/driver.

- 2.1. The vehicle must belong to a vehicle type that is type-approved under this Directive and covered by a certificate of conformity in accordance with Directive 70/156/EEC. It must be registered and used in the European Community.
- 2.2. The vehicle must have been in service for at least 15 000 km or 6 months, whichever is the later, and for no more than 80 000 km or 5 years, whichever is the sooner.
- 2.3. There must be a maintenance record to show that the vehicle has been properly maintained, e. g. has been serviced in accordance with the manufacturer's recommendations.
- 2.4. The vehicle must exhibit no indications of abuse (e. g. racing, overloading, misfuelling, or other misuse), or other factors (e. g. tampering) that could affect emission performance. In the case of vehicles fitted with an OBD system, the fault code and mileage information stored in the computer are taken into account. A vehicle must not be selected for testing if the information stored in the computer shows that the vehicle has operated after a fault code was stored and a relatively prompt repair was not carried out.
- 2.5. There must have been no unauthorized major repair to the engine or major repair of the vehicle.
- 2.6. The lead content and sulphur content of a fuel sample from the vehicle tank must meet applicable standards and there must be no evidence of misfuelling. Checks may be done in the tailpipe, etc.
- 2.7. There must be no indication of any problem that might jeopardize the safety of laboratory personnel.
- 2.8. All anti-pollution system components on the vehicle must be in conformity with the applicable type-approval.

3. DIAGNOSIS AND MAINTENANCE

Diagnosis and any normal maintenance necessary must be performed on vehicles accepted for testing, prior to measuring exhaust emissions, in accordance with the procedure laid down in section 3.1 to 3.7.

- 3.1. The following checks must be carried out: checks on air filter, all drive belts, all fluid levels, radiator cap, all vacuum hoses and electrical wiring related to the antipollution system for integrity; checks on ignition, fuel metering and anti-pollution device components for maladjustments and/or tampering. All discrepancies must be recorded.
- 3.2. The OBD system shall be checked for proper functioning. Any malfunction indications in the OBD memory must be recorded and the requisite repairs must be carried out. If the OBD malfunction indicator registers a malfunction during a preconditioning cycle, the fault may be identified and repaired. The test may be re-run and the results of that repaired vehicle used.
- 3.3. The ignition system must be checked and defective components replaced, for example spark plugs, cables, etc.
- 3.4. The compression must be checked. If the result is unsatisfactory the vehicle is rejected.
- 3.5. The engine parameters must be checked to the manufacturer's specifications and adjusted if necessary.

▼ **M15**

- 3.6. If the vehicle is within 800 km of a scheduled maintenance service, that service must be performed according to the manufacturer's instructions. Regardless of odometer reading, the oil and air filter may be changed at the request of the manufacturer.
 - 3.7. Upon acceptance of the vehicle, the fuel must be replaced with appropriate emission test reference fuel, unless the manufacturer accepts the use of market fuel.
4. IN-SERVICE TESTING
- 4.1. When a check on vehicles is deemed necessary, emission tests in accordance with Annex III to this Directive are performed on pre-conditioned vehicles selected in accordance with the requirements of sections 2 and 3 of this Appendix.
 - 4.2. Vehicles equipped with an OBD system may be checked for proper in-service functionality of the malfunction indication, etc., in relation to levels of emissions (e. g. the malfunction indication limits defined in Annex XI to this Directive) for the type-approved specifications.
 - 4.3. The OBD system may be checked, for example, for levels of emissions above the applicable limit values with no malfunction indication, systematic erroneous activation of the malfunction indication and identified faulty or deteriorated components in the OBD system.
 - 4.4. If a component or system operates in a manner not covered by the particulars in the type-approval certificate and/or information package for such vehicle types and such deviation has not been authorized under Article 5 (3) or (4) of Directive 70/156/EEC, with no malfunction indication by the OBD, the component or system must not be replaced prior to emission testing, unless it is determined that the component or system has been tampered with or abused in such a manner that the OBD does not detect the resulting malfunction.
5. EVALUATION OF RESULTS
- 5.1. The test results are submitted to the evaluation procedure in accordance with Appendix 4 to this Annex.
 - 5.2. Test results must not be multiplied by deterioration factors.
6. PLAN OF REMEDIAL MEASURES
- 6.1. When the type-approval authority is certain that a vehicle type is not in conformity with the requirements of these provisions, it must request the manufacturer to submit a plan of remedial measures to remedy the non-compliance.
 - 6.2. The plan of remedial measures must be filed with the type-approval authority not later than 60 working days from the date of the notification referred to in section 6.1. The type-approval authority must within 30 working days declare its approval or disapproval of the plan of remedial measures. However, where the manufacturer can demonstrate, to the satisfaction of the competent type-approval authority, that further time is required to investigate the non-compliance in order to submit a plan of remedial measures, an extension is granted.
 - 6.3. The remedial measures must apply to all vehicles likely to be affected by the same defect. The need to amend the type-approval documents must be assessed.
 - 6.4. The manufacturer must provide a copy of all communications related to the plan of remedial measures, and must also maintain a record of the recall campaign, and supply regular status reports to the type-approval authority.
 - 6.5. The plan of remedial measures must include the requirements specified in 6.5.1 to 6.5.11. The manufacturer must assign a unique identifying name or number to the plan of remedial measures.
 - 6.5.1. A description of each vehicle type included in the plan of remedial measures.
 - 6.5.2. A description of the specific modifications, alterations, repairs, corrections, adjustments, or other changes to be made to bring the vehicles into conformity including a brief summary of the data and technical studies which support the manufacturer's decision as to the particular measures to be taken to correct the non-conformity.

▼M15

- 6.5.3. A description of the method by which the manufacturer informs the vehicle owners.
- 6.5.4. A description of the proper maintenance or use, if any, which the manufacturer stipulates as a condition of eligibility for repair under the plan of remedial measures, and an explanation of the manufacturer's reasons for imposing any such condition. No maintenance or use conditions may be imposed unless it is demonstrably related to the non-conformity and the remedial measures.
- 6.5.5. A description of the procedure to be followed by vehicle owners to obtain correction of the non-conformity. This must include a date after which the remedial measures may be taken, the estimated time for the workshop to perform the repairs and where they can be done. The repair must be done expediently, within a reasonable time after delivery of the vehicle.
- 6.5.6. A copy of the information transmitted to the vehicle owner.
- 6.5.7. A brief description of the system which the manufacturer uses to assure an adequate supply of component or systems for fulfilling the remedial action. It must be indicated when there will be an adequate supply of components or systems to initiate the campaign.
- 6.5.8. A copy of all instructions to be sent to those persons who are to perform the repair.
- 6.5.9. A description of the impact of the proposed remedial measures on the emissions, fuel consumption, driveability, and safety of each vehicle type, covered by the plan of remedial measures with data, technical studies, etc. which support these conclusions.
- 6.5.10. Any other information, reports or data the type-approval authority may reasonably determine is necessary to evaluate the plan of remedial measures.
- 6.5.11. Where the plan of remedial measures includes a recall, a description of the method for recording the repair must be submitted to the type-approval authority. If a label is used, an example of it must be submitted.
- 6.6. The manufacturer may be required to conduct reasonably designed and necessary tests on components and vehicles incorporating a proposed change, repair, or modification to demonstrate the effectiveness of the change, repair, or modification.
- 6.7. The manufacturer is responsible for keeping a record of every vehicle recalled and repaired and the workshop which performed the repair. The type-approval authority must have access to the record on request for a period of 5 years from the implementation of the plan of remedial measures.
- 6.8. The repair and/or modification or addition of new equipment shall be recorded in a certificate supplied by the manufacturer to the vehicle owner.

▼M15

Appendix 4⁽¹⁾

STATISTICAL PROCEDURE FOR IN-SERVICE CONFORMITY TESTING

1. This Appendix describes the procedure to be used to verify the in-service conformity requirements for the type I test.
2. Two different procedures are to be followed:
 1. One dealing with vehicles identified in the sample, due to an emission-related defect, causing outliers in the results (section 3).
 2. The other dealing with the total sample (section 4).
3. PROCEDURE TO BE FOLLOWED WITH OUTLYING EMITTERS IN THE SAMPLE.
 - 3.1. A vehicle is said to be an outlying emitter, when for any regulated component the limit value as shown in section 5.3.1.4 of Annex I is exceeded significantly.
 - 3.2. With a minimum sample size of 3, and a maximum sample size as determined by the procedure of paragraph 4, the sample is scanned for the occurrence of outlying emitters.
 - 3.3. When an outlying emitter is found, the cause of the excess emission must be determined.
 - 3.4. When more than one vehicle is found to be an outlying emitter, due to the same cause, the sample is regarded as having failed.
 - 3.5. When only one outlying emitter has been found, or when more than one outlying emitter is found, but due to different causes, the sample is increased by one vehicle, unless the maximum sample size has already been reached.
 - 3.5.1. When in the increased sample more than one vehicle is found to be an outlying emitter, due to the same cause, the sample is regarded as having failed.
 - 3.5.2. When in the maximum sample size not more than one outlying emitter is found, where the excess emission is due to the same cause, the sample is regarded as having passed with regard to the requirements of section 3 of this Appendix.
 - 3.6. Whenever a sample is increased due to the requirements of 3.5, the statistical procedure of paragraph 4 is applied to the increased sample.
4. PROCEDURE TO BE FOLLOWED WITHOUT SEPARATE EVALUATION OF OUTLYING EMITTERS IN THE SAMPLE.
 - 4.1. With a minimum sample size of three the sampling procedure is set so that the probability of a batch passing a test with 40 % of the production defective is 0,95 (producer's risk = 5 %) while the probability of a batch being accepted with 75 % of the production defective is 0,15 (consumer's risk = 15 %).
 - 4.2. For each of the pollutants given in ►C3 section 5.3.1.4 of Annex I, ◀ the following procedure is used (see Figure I/7).

Where

L = the limit value for the pollutant,
 X_i = the value of the measurement for the i-th vehicle of the sample,
 n = the current sample number.
 - 4.3. The test statistic quantifying the number of non-conforming vehicles, i. e. $x_i > L$, is computed for the sample.
 - 4.4. Then:
 - if the test statistic does not exceed the pass decision number for the sample size given in the following table, a pass decision is reached for the pollutant,

(1) The provisions laid down in Appendix 4 must be re-examined and completed without delay in accordance with the procedure laid down in Article 13 of Directive 70/156/EEC.

▼M15

- if the test statistic equals or exceeds the fail decision number for the sample size given in the following table, a fail decision is reached for the pollutant,
- otherwise, an additional vehicle is tested and the procedure is applied to the sample with one extra unit.

In the following table the pass and fail decision numbers are computed in accordance with the International Standard ISO 8422:1991.

5. A sample is regarded as having passed the test when it has passed both the requirements of sections 3 and 4 of this Appendix.

Table for Acceptance — Rejection Sampling Plan by Attributes

| Cumulative sample size | Pass decision number | Fail decision number |
|------------------------|----------------------|----------------------|
| 3 | 0 | — |
| 4 | 1 | — |
| 5 | 1 | 5 |
| 6 | 2 | 6 |
| 7 | 2 | 6 |
| 8 | 3 | 7 |
| 9 | 4 | 8 |
| 10 | 4 | 8 |
| 11 | 5 | 9 |
| 12 | 5 | 9 |
| 13 | 6 | 10 |
| 14 | 6 | 11 |
| 15 | 7 | 11 |
| 16 | 8 | 12 |
| 17 | 8 | 12 |
| 18 | 9 | 13 |
| 19 | 9 | 13 |
| 20 | 11 | 12 |

▼M15

Figure I.7

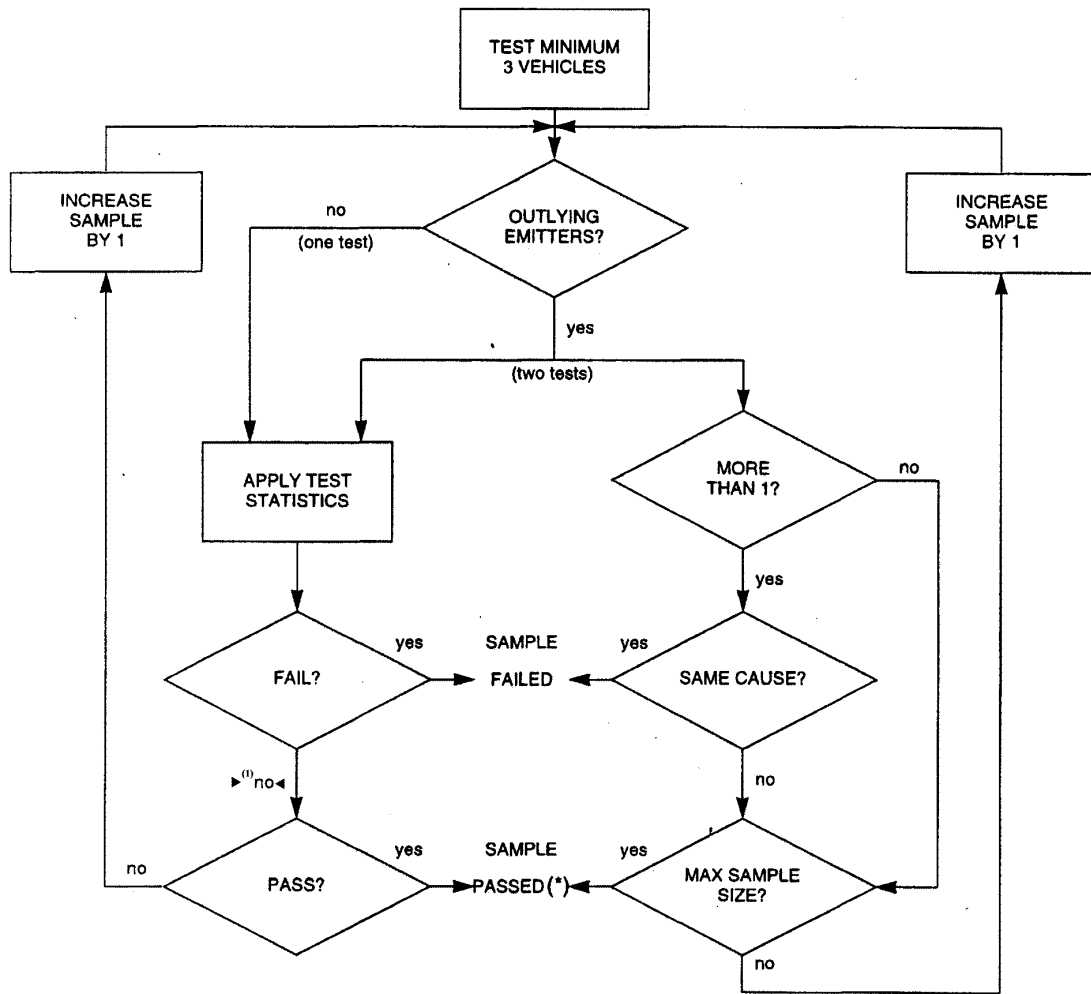

(*) If it fulfills both tests .

▼ **M12***ANNEX II***INFORMATION DOCUMENT No ...**

pursuant to Annex I of Directive 70/156/EEC (*) relating to EEC type-approval of a vehicle with respect to the measures to be taken against air pollution by emissions from motor vehicles (Directive 70/220/EEC, as last amended by Directive .../.../EC)

The following information, if applicable, must be supplied in triplicate and include a list of contents. Any drawings must be supplied in appropriate scale and in sufficient detail on size A4 or on a folder of A4 format. Photographs, if any, must show sufficient detail.

If the systems, components or separate technical units have electronic controls, information concerning their performance must be supplied.

- 0. GENERAL
 - 0.1. Make (trade name of manufacturer):
 - 0.2. Type and general commercial description(s):
 - 0.3. Means of identification of type, if marked on the vehicle (†):
 - 0.3.1. Location of that marking:
 - 0.4. Category of vehicle (‡):
 - 0.5. Name and address of manufacturer:
 - 0.8. Address(es) of assembly plant(s):
- 1. GENERAL CONSTRUCTION CHARACTERISTICS OF THE VEHICLE
 - 1.1. Photographs and/or drawings of a representative vehicle:
 - 1.3.3. Powered axles (numbers, position, interconnection):
- 2. MASSES AND DIMENSION (¶) (in kg and mm)
(Refer to drawing where applicable)
 - 2.6. Mass of vehicle with bodywork in running order, or mass of the chassis with cab if the manufacturer does not fit the bodywork (with standard equipment, including coolant, oils, fuel, tools, spare wheel and driver) (¶) (maximum and minimum):
 - 2.8. Technically permissible maximum laden mass stated by the manufacturer (¶) (maximum and minimum):
- 3. POWER PLANT (¶)
 - 3.1. Manufacturer:
 - 3.1.1. Manufacturer's engine code (As marked on the engine, or other means of identification):
 - 3.2. Internal combustion engine
 - 3.2.1.1. Working principle: positive ignition/compression ignition, four stroke/two stroke (¶)

(*) The item numbers and footnotes used in this information document correspond to those set out in Annex I to Directive 70/156/EEC. Items not relevant for the purpose of this Directive are omitted.

▼ **M12**

- 3.2.1.2. Number and arrangements of cylinders:
- 3.2.1.2.1. Bore (°): mm
- 3.2.1.2.2. Stroke (°): mm
- 3.2.1.2.3. Firing order:
- 3.2.1.3. Engine capacity (°): cm³
- 3.2.1.4. Volumetric compression ratio (°):
- 3.2.1.5. Drawings of combustion chamber, piston crown and, in the case of positive ignition engine, piston rings:
- ▶⁽¹⁾ 3.2.1.6. Normal engine idling speed (including tolerance) min⁻¹
- 3.2.1.6.1. High idle engine speed (including tolerance) min⁻¹ ◀
- 3.2.1.7. Carbon monoxide content by volume in the exhaust gas with the engine idling (°): % as stated by the manufacturer (positive ignition engines only)
- 3.2.1.8. Maximum net power (°): kW at min⁻¹ (manufacturer's declared value)
- ▶⁽¹⁾ 3.2.2. Fuel: Diesel oil/Petrol/LPG/NG (°) ◀
- 3.2.2.1. RON, leaded:
- 3.2.2.2. RON, unleaded:
- 3.2.2.3. Fuel tank inlet: restricted orifice/label (°)
- 3.2.4. Fuel feed
- 3.2.4.1. By carburettor(s): yes/no (°)
- 3.2.4.1.1. Make(s):
- 3.2.4.1.2. Type(s):
- 3.2.4.1.3. Number fitted:
- 3.2.4.1.4. Adjustments (°):
- 3.2.4.1.4.1. Jets: }
 3.2.4.1.4.2. Venturis: }
 3.2.4.1.4.3. Float-chamber level: } Or the curve of fuel delivery plotted against the air
 3.2.4.1.4.4. Mass of float: } flow and settings required to keep to the curve
 3.2.4.1.4.5. Float needle: }
- 3.2.4.1.5. Cold start system: manual/automatic (°)
- 3.2.4.1.5.1. Operating principle(s):
- 3.2.4.1.5.2. Operating limits/settings (°) (°):
- 3.2.4.2. By fuel injection (compression ignition only): yes/no (°)
- 3.2.4.2.1. System description:
- 3.2.4.2.2. Working principle: direct injection/pre-chamber/swirl chamber (°)
- 3.2.4.2.3. Injection pump
- 3.2.4.2.3.1. Make(s):
- 3.2.4.2.3.2. Type(s):
- 3.2.4.2.3.3. Maximum fuel delivery (°) (°): mm³/stroke or cycle at a pump speed of: min⁻¹ or, alternatively, a characteristic diagram:
- 3.2.4.2.3.4. Injection timing (°):
- 3.2.4.2.3.5. Injection advance curve (°):
- 3.2.4.2.3.6. Calibration procedure: test bench/engine (°)
- 3.2.4.2.4. Governor

▶⁽¹⁾ **M14**▶⁽²⁾ **M15**

▼ **M12**

- 3.2.4.2.4.1. Type:
- 3.2.4.2.4.2. Cut-off point
- 3.2.4.2.4.2.1. Cut-off point under load: min⁻¹
- 3.2.4.2.4.2.2. Cut-off point without load: min⁻¹
- 3.2.4.2.6. Injector(s)
- 3.2.4.2.6.1. Make(s):
- 3.2.4.2.6.2. Type(s):
- 3.2.4.2.6.3. Opening pressure (?): kPa or characteristic diagram (?):
- 3.2.4.2.7. Cold start system
- 3.2.4.2.7.1. Make(s):
- 3.2.4.2.7.2. Type(s):
- 3.2.4.2.7.3. Description:
- 3.2.4.2.8. Auxiliary starting aid
- 3.2.4.2.8.1. Make(s):
- 3.2.4.2.8.2. Type(s):
- 3.2.4.2.8.3. System description:
- 3.2.4.3. By fuel injection (positive ignition only): yes/no (!)
- 3.2.4.3.1. Working principle: Intake manifold (single-/multi-point (!))/direct injection/other (specify) (!):
.....
- 3.2.4.3.2. Make(s):
- 3.2.4.3.3. Type(s):
- 3.2.4.3.4. System description:
- 3.2.4.3.4.1. Type or number of the control unit:
- 3.2.4.3.4.2. Type of fuel regulator:
- 3.2.4.3.4.3. Type of air-flow sensor:
- 3.2.4.3.4.4. Type of fuel distributor:
- 3.2.4.3.4.5. Type of pressure regulator:
- 3.2.4.3.4.6. Type of microswitch:
- 3.2.4.3.4.7. Type of idling adjustment screw:
- 3.2.4.3.4.8. Type of throttle housing:
- 3.2.4.3.4.9. Type of water temperature sensor:
- 3.2.4.3.4.10. Type of air temperature sensor:
- 3.2.4.3.4.11. Type of temperature switch:
- 3.2.4.3.5. Injectors: opening pressure (?): kPa or characteristic diagram (?):
- 3.2.4.3.6. Injection timing:
- 3.2.4.3.7. Cold start system
- 3.2.4.3.7.1. Operating principle(s):
- 3.2.4.3.7.2. Operating limits/settings (!) (?):
- 3.2.4.4. Feed pump
- 3.2.4.4.1. Pressure (?): kPa or characteristic diagram (?):
- 3.2.6. Ignition
- 3.2.6.1. Make(s):

In the case of systems other than continuous injection give equivalent details

▼ **M12**

- 3.2.6.2. Type(s):
- 3.2.6.3. Working principle:
- 3.2.6.4. Ignition advance curve (°):
- 3.2.6.5. Static ignition timing (°): degrees before TDC
- 3.2.6.6. Contact-point gap (°): mm
- 3.2.6.7. Dwell-angle (°): degrees
- 3.2.7. Cooling system (liquid/air) (°)
- 3.2.8. Intake system
- 3.2.8.1. Pressure charger: yes/no (°)
- 3.2.8.1.1. Make(s):
- 3.2.8.1.2. Type(s):
- 3.2.8.1.3. Description of the system (e.g. maximum charge pressure: kPa, wastegate if applicable):
.....
- 3.2.8.2. Intercooler: yes/no (°)
- 3.2.8.4. Description and drawings of the inlet pipes and their accessories (plenum chamber, heating device, additional air intakes, etc.):
- 3.2.8.4.1. Intake manifold description (include drawings and/or photos):
- 3.2.8.4.2. Air filter, drawings:, or
- 3.2.8.4.2.1. Make(s):
- 3.2.8.4.2.2. Type(s):
- 3.2.8.4.3. Intake silencer, drawings:, or
- 3.2.8.4.3.1. Make(s):
- 3.2.8.4.3.2. Type(s):
- 3.2.9. Exhaust system
- 3.2.9.2. Description and/or drawing of the exhaust system:
- 3.2.11. Valve timing or equivalent data
- 3.2.11.1. Maximum lift of valve, angles of opening and closing, or timing details of alternative distribution system, in relation to dead centres:
- 3.2.11.2. Reference and/or setting ranges (°):
- 3.2.12. Measures taken against air pollution
- 3.2.12.1. Device for recycling crankcase gases (description and drawings):
- 3.2.12.2. Additional anti-pollution devices (if any, and if not covered by another heading)
- 3.2.12.2.1. Catalytic converter: yes/no (°)
- 3.2.12.2.1.1. Number of catalytic converters and elements:
- 3.2.12.2.1.2. Dimensions, shape and volume of the catalytic converter(s):
- 3.2.12.2.1.3. Type of catalytic action:
- 3.2.12.2.1.4. Total charge of precious metals:
- 3.2.12.2.1.5. Relative concentration:
- 3.2.12.2.1.6. Substrate (structure and material):
- 3.2.12.2.1.7. Cell density:
- 3.2.12.2.1.8. Type of casing for the catalytic converter(s):
- 3.2.12.2.1.9. Location of the catalytic converter(s) (place and reference distance in the exhaust line):

▼ **M12**

- 3.2.12.2.1.10. Heat shield: yes/no ⁽¹⁾
- 3.2.12.2.2. Oxygen sensor: yes/no ⁽¹⁾
- 3.2.12.2.2.1. Type:
- 3.2.12.2.2.2. Location:
- 3.2.12.2.2.3. Control range:
- 3.2.12.2.3. Air injection: yes/no ⁽¹⁾
- 3.2.12.2.3.1. Type (pulse air, air pump etc.):
- 3.2.12.2.4. Exhaust gas recirculation: yes/no ⁽¹⁾
- 3.2.12.2.4.1. Characteristics (flow rate etc.):
- 3.2.12.2.5. Evaporative emissions control system: yes/no ⁽¹⁾
- 3.2.12.2.5.1. Detailed description of the devices and their state of tune:
- 3.2.12.2.5.2. Drawing of the evaporative control system:
- 3.2.12.2.5.3. Drawing of the carbon canister:
- 3.2.12.2.5.4. Mass of dry charcoal: g
- 3.2.12.2.5.5. Schematic drawing of the fuel tank with indication of capacity and material:
- 3.2.12.2.5.6. Drawing of the heat shield between tank and exhaust system:
- 3.2.12.2.6. Particulate trap: yes/no ⁽¹⁾
- 3.2.12.2.6.1. Dimensions, shape and capacity of the particulate trap:
- 3.2.12.2.6.2. Type and design of the particulate trap:
- 3.2.12.2.6.3. Location (reference distance in the exhaust line):
- 3.2.12.2.6.4. Method or system of regeneration, description and/or drawing:
- 3.2.12.2.7. Other systems (description and operation):
- ▶⁶⁰ 3.2.12.2.8. On-board-diagnostic (OBD) system
- 3.2.12.2.8.1. Written description and/or drawing of the MI:
.....
- 3.2.12.2.8.2. List and purpose of all components monitored by the OBD system:
.....
- 3.2.12.2.8.3. Written description (general working principles) for:
.....
- 3.2.12.2.8.3.1. Positive-ignition engines ⁽¹⁾:
.....
- 3.2.12.2.8.3.1.1. Catalyst monitoring ⁽¹⁾:
.....
- 3.2.12.2.8.3.1.2. Misfire detection ⁽¹⁾:
.....
- 3.2.12.2.8.3.1.3. Oxygen sensor monitoring ⁽¹⁾:
.....
- 3.2.12.2.8.3.1.4. Other components monitored by the OBD system ⁽¹⁾:
.....
- 3.2.12.2.8.3.2. Compression-ignition engines ⁽¹⁾:

⁽¹⁾ Delete where not applicable. ◀

▼ **M12**

- ▶^(a) 3.2.12.2.8.3.2.1. Catalyst monitoring ⁽¹⁾:
.....
- 3.2.12.2.8.3.2.2. Particulate trap monitoring ⁽¹⁾:
.....
- 3.2.12.2.8.3.2.3. Electronic fuelling system monitoring ⁽¹⁾:
.....
- 3.2.12.2.8.3.2.4. Other components monitored by the OBD system ⁽¹⁾:
.....
- 3.2.12.2.8.4. Criteria for MI activation (fixed number of driving cycles or statistical method):
.....
- 3.2.12.2.8.5. List of all OBD output codes and formats used (with explanation of each):
.....◀
- ▶^(b) 3.2.15. LPG fuelling system: yes/no ⁽¹⁾
 - 3.2.15.1. Approval number according to Directive 70/221/EEC (*):
 - 3.2.15.2. Electronic engine management control unit for LPG fuelling:
 - 3.2.15.2.1. Make(s):
 - 3.2.15.2.2. Type(s):
 - 3.2.15.2.3. Emission-related adjustment possibilities:
 - 3.2.15.3. Further documentation:
 - 3.2.15.3.1. Description of the safeguarding of the catalyst at switch-over from petrol to LPG or back:
 - 3.2.15.3.2. System lay-out (electrical connections, vacuum connections compensation hoses, etc.):
 - 3.2.15.3.3. Drawing of the symbol:
 - 3.2.16. NG fuelling system: yes/no ⁽¹⁾
 - 3.2.16.1. Approval number according to Directive 70/221/EEC (*):
 - 3.2.16.2. Electronic engine management control unit for NG fuelling:
 - 3.2.16.2.1. Make(s):
 - 3.2.16.2.2. Type(s):
 - 3.2.16.2.3. Emission-related adjustment possibilities:
 - 3.2.16.3. Further documentations:
 - 3.2.16.3.1. Description of the safeguarding of the catalyst at switch-over from petrol to NG or back:
 - 3.2.16.3.2. System lay-out (electrical connections, vacuum connections compensation hoses, etc.):
 - 3.2.16.3.3. Drawing of the symbol:

⁽¹⁾ Delete where not applicable.

^(*) When this Directive will be amended to cover tanks for gaseous fuels. ◀

▼M12

4. TRANSMISSION (1)

4.4. Clutch (type):

4.4.1. Maximum torque conversion:

4.5. Gearbox

4.5.1. Type (manual/automatic/CVT (1)):

4.6. Gear ratios

| Gear | Internal gearbox ratios (ratio of engine to gearbox output shaft revolutions) | Final drive ratio(s) (ratio of gearbox output shaft to driven wheel revolutions) | Total gear ratios |
|------------------------|--|--|----------------------|
| Maximum for CVT (1) | | | |
| 1 | | | |
| 2 | | | |
| 3 | | | |
| ... | | | |
| Minimum for CVT (1) | | | |
| Reverse | | | |

(1) Continuously variable transmission

6. SUSPENSION

6.6. Tyres and wheels

6.6.1. Tyre / wheel combination(s) (for tyres indicate size designation, minimum load-capacity index, minimum speed category symbol; for wheels indicate rim size(s) and off-set(s))

6.6.1.1. Axles

6.6.1.1.1. Axle 1:

6.6.1.1.2. Axle 2:

6.6.1.1.3. Axle 3:

6.6.1.1.4. Axle 4:

etc.

6.6.2. Upper and lower limits of rolling radii

6.6.2.1. Axle 1:

6.6.2.2. Axle 2:

6.6.2.3. Axle 3:

6.6.2.4. Axle 4:

etc.

6.6.3. Tyre pressure(s) as recommended by the vehicle manufacturer: kPa

9. BODYWORK

9.10.3. Seats

9.10.3.1. Number:

Date, file

▼ M12

Appendix

INFORMATION ON TEST CONDITIONS

1. **Spark plugs**
 - 1.1. Make:
 - 1.2. Type:
 - 1.3. Spark-gap setting:

2. **Ignition coil**
 - 2.1. Make:
 - 2.2. Type:

3. **Ignition condenser**
 - 3.1. Make:
 - 3.2. Type:

4. **Lubricant used**
 - 4.1. Make:
 - 4.2. Type:

▼ M9*ANNEX III***TYPE I TEST****(Verifying the average emission of tailpipe emissions after a cold start)****▼ M14**

1. INTRODUCTION

This Annex describes the procedure for the type I test defined in 5.3.1 of Annex I. When the reference fuel to be used is LPG or NG, the provisions of Annex XII shall apply additionally.

▼ M9

2. OPERATING CYCLE ON THE CHASSIS DYNAMOMETER

2.1. **Description of the cycle**

The operating cycle on the chassis dynamometer is described in Appendix 1 to this Annex.

2.2. **General conditions under which the cycle is carried out**

Preliminary testing cycles must be carried out if necessary to determine how best to actuate the accelerator and brake controls so as to achieve a cycle approximating to the theoretical cycle within the prescribed limits.

2.3. **Use of gearbox**

- 2.3.1. If the maximum speed which can be attained in first gear is below 15 km/h, the second, third and fourth gears are used for the elementary urban cycles (Part One) and the second, third, fourth and fifth gears for the extra-urban cycle (Part Two). The second, third and fourth gears may also be used for the urban cycle (Part One) and the second, third, four and fifth gears for the extra-urban cycle (Part Two) when the driving instructions recommend starting in second gear on level ground, or when first gear is therein defined as a gear reserved for cross-country driving, crawling or towing.

▼ M15**▼ M10**

► **M15** Vehicles which do not attain the acceleration ◀ and maximum speed values required in the operating cycle must be operated with the accelerator control fully depressed until they once again reach the required operating curve. Deviations from the operating cycle must be recorded in the test report.

▼ M9

- 2.3.2. Vehicles equipped with semi-automatic-gearboxes are tested by using the gears normally employed for driving, and the gear is used in accordance with the manufacturer's instructions.

- 2.3.3. Vehicles equipped with automatic gearboxes are tested with the highest gear (drive) engaged. The accelerator must be used in such a way as to obtain the steadiest acceleration possible, enabling the various gears to be engaged in the normal order. Furthermore, the gear-change points shown in Appendix 1 to this Annex do not apply; acceleration must continue throughout the period represented by the straight line connecting the end of each period of idling with the beginning of the next following period of steady speed. The tolerances given in 2.4 apply.

- 2.3.4. Vehicles equipped with an overdrive which the driver can activate are tested with the overdrive out of action for the urban cycle (Part One) and with the overdrive in action for the extra-urban cycle (Part Two).

2.4. **Tolerances**

- 2.4.1. A tolerance of ± 2 km/h is allowed between the indicated speed and the theoretical speed during acceleration, during steady speed, and during deceleration when the vehicle's brakes are used. If the vehicle decelerates more rapidly without the use of

▼ M9

the brakes, only the requirements of 6.5.3 apply. Speed tolerances greater than those prescribed are accepted during phase changes provided that the tolerances are never exceeded for more than 0,5 on any one occasion.

- 2.4.2. The time tolerances are $\pm 1,0$ s. The above tolerances apply equally at the beginning and at the end of each gear changing period⁽¹⁾ for the urban cycle (Part One) and for the operations Nos 3, 5 and 7 of the extra-urban cycle (Part Two).
- 2.4.3. The speed and time tolerances are combined as indicated in Appendix 1.

3. VEHICLE AND FUEL

3.1. Test vehicle

- 3.1.1. The vehicle must be presented in good mechanical condition. It must have been run-in and driven at least 3 000 kilometres before the test.
- 3.1.2. The exhaust device must not exhibit any leak likely to reduce the quantity of gas collected, which quantity must be that emerging from the engine.
- 3.1.3. The tightness of the intake system may be checked to ensure that carburation is not affected by an accidental intake of air.
- 3.1.4. The settings of the engine and of the vehicle's controls must be those prescribed by the manufacturer. This requirement also applies, in particular, to the settings for idling (rotation speed and carbon monoxide content of the exhaust gases), for the cold start device and for the exhaust gas pollutant emission control system.
- 3.1.5. The vehicle to be tested, or an equivalent vehicle, must be fitted, if necessary, with a device to permit the measurement of the characteristic parameters necessary for chassis dynamometer setting, in conformity with 4.1.1.
- 3.1.6. The technical service may verify that the vehicle's performance conforms to that stated by the manufacturer, that it can be used for normal driving and, more particularly, that it is capable of starting when cold and when hot.

3.2. Fuel

The appropriate reference fuel as defined in Annex VIII must be used for testing.

▼ M14

- 3.2.1. Vehicles that are fuelled either with petrol or with LPG or NG shall be tested according to Annex XII with the appropriate reference fuel(s) as defined in Annex IX a.

▼ M9

4. TEST EQUIPMENT

4.1. Chassis dynamometer

- 4.1.1. The dynamometer must be capable of simulating road load within one of the following classifications:
- dynamometer with fixed load curve, i.e. a dynamometer whose physical characteristics provide a fixed load curve shape,
 - dynamometer with adjustable load curve, i.e. a dynamometer with at least two road load parameters that can be adjusted to shape the load curve.
- 4.1.2. The setting of the dynamometer must not be affected by the lapse of time. It must not produce any vibrations perceptible to the vehicle and likely to impair the vehicle's normal operations.

⁽¹⁾ It should be noted that the time of two seconds allowed includes the time for changing gear and, if necessary, a certain amount of latitude to catch up with the cycle.

▼ **M9**

- 4.1.3. It must be equipped with means to simulate inertia and load. These simulators are connected to the front roller in the case of a two-roller dynamometer.
- 4.1.4. *Accuracy*
- 4.1.4.1. It must be possible to measure and read the indicated load to an accuracy of $\pm 5\%$.
- 4.1.4.2. In the case of a dynamometer with a fixed load curve the accuracy of the load setting at 80 km/h must be $\pm 5\%$. In the case of a dynamometer with an adjustable load curve, the accuracy of matching dynamometer load to road load ► **M12** must be 5 % at 120, 100, 80, 60 and 40, and 10 % at 20 km/h. ◀ Below this, dynamometer absorption must be positive.
- 4.1.4.3. The total inertia of the rotating parts (including the simulated inertia where applicable) must be known and must be within ± 20 kilograms of the inertia class for the test.
- 4.1.4.4. The speed of the vehicle must be measured by the speed of rotation of the roller (the front roller in the case of a two roller dynamometer). It must be measured with an accuracy of ± 1 km/h at speeds above 10 km/h.
- 4.1.5. *Load and inertia setting*
- 4.1.5.1. Dynamometer with fixed load curve: the load simulator must be adjusted to absorb the power exerted on the driving wheels at a steady speed of 80 km/h and the absorbed power at 50 km/h shall be noted. The means by which this load is determined and set are described in Appendix 3.
- 4.1.5.2. Dynamometer with adjustable load curve: the load simulator must be adjusted in order to absorb the power exerted on the driving wheels at steady ► **M12** speeds of 120, 100, 80, 60, 40 and 20 km/h. ◀ The means by which these loads are determined and set are described in Appendix 3.
- 4.1.5.3. *Inertia*
- Dynamometers with electrical inertia simulation must be demonstrated to be equivalent to mechanical inertia systems. The means by which equivalence is established is described in Appendix 4.
- 4.2. **Exhaust-gas sampling system**
- 4.2.1. The exhaust gas sampling system must be able to measure the actual quantities of pollutants emitted in the exhaust gases to be measured. The system to be used is the constant volume sampler (CVS) system. This requires that the vehicle exhaust be continuously diluted with ambient air under controlled conditions. In the constant volume sampler concept of measuring two conditions must be satisfied: the total volume of the mixture of exhaust gases and dilution air must be measured and a continuously proportional sample of the volume must be collected for analysis.
- The quantities of pollutants emitted are determined from the sample concentrations, corrected for the pollutant content of the ambient air and the totalized flow over the test period.
- The particulate pollutant emission level is determined by using suitable filters to collect the particulates from a proportional part flow throughout the test and determining the quantity thereof gravimetrically in accordance with 4.3.2.
- 4.2.2. The flow through the system must be sufficient to eliminate water condensation at all conditions which may occur during a test, as defined in Appendix 5.
- 4.2.3. ► **M12** ————— ◀ Appendix 5 gives examples of three types of constant volume sampler system which satisfy the requirements set out in this Annex.
- 4.2.4. The gas and air mixture must be homogeneous at point S₂ of the sampling probe.
- 4.2.5. The probe must extract a true sample of the diluted exhaust gases.
- 4.2.6. The system must be free of gas leaks. The design and materials must be such that the system does not influence the pollutant concentration in the diluted exhaust gas. Should any component

▼ **M9**

(heat exchanger, blower, etc.) change the concentration of any pollutant gas in the diluted gas, the sampling for that pollutant must be carried out before that component if the problem cannot be corrected.

▼ **M12**▼ **M9**

- 4.2.7. If the vehicle being tested is equipped with an exhaust pipe comprising several branches, ► **M12** the connecting tubes must be connected as near as possible to the vehicle but in such a manner so as not to effect the functioning of the vehicle. ◀
- 4.2.8. Static pressure variations at the tailpipe(s) of the vehicle must remain within $\pm 1,25$ kPa of the static pressure variations measured during the dynamometer driving cycle with no connection to the tailpipe(s). Sampling systems capable of maintaining the static pressure to within $\pm 0,25$ kPa are used if a written request from a manufacturer to the competent authority issuing the approval substantiates the need for the narrower tolerance. The back-pressure must be measured in the exhaust pipe, as near as possible to its end or in an extension having the same diameter.
- 4.2.9. The various valves used to direct the exhaust gases must be of a quick-adjustment, quick-acting type.
- 4.2.10. The gas samples are collected in sample bags of adequate capacity. These bags must be made of such materials as will not change the pollutant gas by more than ± 2 % after 20 minutes of storage.

4.3. **Analytical equipment**4.3.1. *Requirements*

4.3.1.1. Pollutant gases must be analyzed with the following instruments:

Carbon monoxide (CO) and carbon dioxide (CO₂) analysis:

The carbon monoxide and carbon dioxide analysers must be of the non-dispersive infra-red (NDIR) absorption type.

Hydrocarbons (HC) analysis — spark-ignition engines:

The hydrocarbons analyser must be of the flame ionization (FID) type calibrated with propane gas expressed equivalent to carbon atoms (C_p).

Hydrocarbons (HC) analysis — compression-ignition engines:

The hydrocarbons analyser must be of the flame ionization type with detector, valves, pipework, etc, heated to 463 K (190 °C) ± 10 K (HFID). It must be calibrated with propane gas expressed equivalent to carbon atoms (C_p).

Nitrogen oxide (NO_x) analysis:

The nitrogen oxide analyser must be either of the chemiluminescent (CLA) or of the non-dispersive ultraviolet resonance absorption (NDUVR) type, both with an NO_x — NO converter.

Particulates:

Gravimetric determination of the particulates collected. These particulates are in each case collected by two series-mounted filters in the sample gas flow. The quantity of particulates collected by each pair of filters must be as follows:

- V_{ep}: flow through filters
- V_{mix}: flow through tunnel
- M: particulates mass (g/km)
- M_{limit}: limit mass of particulates (limit mass in force, g/km)
- m: mass of particulates collected by filters (g)
- d: actual distance corresponding to the operating cycle (km)

$$M = \frac{V_{\text{mix}} \cdot m}{V_{\text{ep}} \cdot d} \text{ or } m = M \cdot d \cdot \frac{V_{\text{ep}}}{V_{\text{mix}}}$$

▼ **M9**

The particulates sample rate (V_{ep}/V_{mix}) will be adjusted so that for $M = M_{limit}$, $1 \leq m \leq 5$ mg (when 47 mm diameter filters are used).

The filter surface consist of a material that is hydrophobic and inert towards the components of the exhaust gas (fluorocarbon-coated glass-fibre filters or equivalent).

4.3.1.2. Accuracy

The analysers must have a measuring range compatible with the accuracy required to measure the concentrations of the exhaust gas sample pollutants.

▼ **M12**

Measurement error must not exceed ± 2 % (intrinsic error of analyser) disregarding the true value for the calibration gases. For concentrations of less than 100 ppm the measurement error must not exceed ± 2 ppm. The ambient air sample must be measured on the same analyser with an appropriate range.

▼ **M9**

Measurement of the particulates collected shall be to a guaranteed accuracy of 1 μ g.

▼ **M12**

The microgram balance used to determine the weight of all filters must have an accuracy of 5 μ g and readability of 1 μ g.

▼ **M9**

4.3.1.3. Ice-trap

No gas drying device must be used before the analysers unless shown to have no effect on the pollutant content of the gas stream.

4.3.2. *Particular requirements for compression-ignition engines*

A heated sample line for a continuous HC-analysis with the flame ionization detector (HFID), including recorder (R) must be used. The average concentration of the measured hydrocarbons must be determined by integration. Throughout the test, the temperature of the heated sample line must be controlled at 463 K (190 °C) \pm 10 K. The heated sampling line must be fitted with a heated filter (Fh) 99 % efficient with particle $\geq 0,3$ μ m to extract any solid particles from the continuous flow of gas required for analysis. The sampling system response time (from the probe to the analyser inlet) must be no more than four seconds.

The HFID must be used with a constant flow (heat exchanger) system to ensure a representative sample, unless compensation for varying CFV or CFO flows is made.

The particulate sampling unit consists of a dilution tunnel, a sampling probe, a filter unit, a partial-flow pump, and a flow rate regulator and measuring unit. The particulate-sampling part flow is drawn through two series-mounted filters. ► **M12** The sampling probe for the test gas flow for particulates must be so arranged within the dilution tract that a representative sample gas flow can be taken from the homogeneous air/exhaust mixture and an air/exhaust gas mixture temperature of 325 K (52 °C) is not exceeded immediately before the particulate filter. ◀. The temperature of the gas flow in the flow meter may not fluctuate more than ± 3 K, nor may the mass flow-rate fluctuate by more than ± 5 %. Should the volume of flow change unacceptably as a result of excessive filter loading, the test must be stopped. When it is repeated, the rate of flow must be decreased and/or a larger filter used. The filters must be removed from the chamber no earlier than an hour before the test begins.

The necessary particle filters must be conditioned (as regards temperature and humidity) in an open dish which has been protected against dust ingress for at least eight and for not more than 56 hours before the test in an air-conditioned chamber. After this conditioning the uncontaminated filters are weighed and stored until they are used.

If the filters are not used within one hour of their removal from the weighing chamber they must be reweighed.

▼ **M9**

The one-hour limit may be replaced by an eight-hour limit if one or both of the following conditions are met:

- a stabilized filter is placed and kept in a sealed filter holder assembly with the ends plugged, or
- a stabilized filter is placed in a sealed filter holder assembly which is then immediately placed in a sample line through which there is no flow.

4.3.3. *Calibration*

Each analyser must be calibrated as often as necessary and in any case in the month before type-approval testing and at least once every six months for verifying conformity of production. The calibration method to be used is described in Appendix 6 for the analysers referred to in 4.3.1.

4.4. **Volume measurement**

4.4.1. The method of measuring total dilute exhaust volume incorporated in the constant volume sampler must be such that measurement is accurate to $\pm 2\%$.

4.4.2. *Constant volume sampler calibration*

The constant volume sampler system volume measurement device must be calibrated by a method sufficient to ensure the prescribed accuracy and at a frequency sufficient to maintain such accuracy.

An example of a calibration procedure which gives the required accuracy is given in Appendix 6. The method utilizes a flow metering device which is dynamic and suitable for the high flow-rate encountered in constant volume sampler testing. The device must be of certified accuracy in conformity with an approved national or international standard.

4.5. **Gases**4.5.1. *Pure gases*

The following pure gases must be available, if necessary, for calibration and operation:

- purified nitrogen
(purity ≤ 1 ppm C, ≤ 1 ppm CO, ≤ 400 ppm CO₂, $\leq 0,1$ ppm NO),
- purified synthetic air
(purity, ≤ 1 ppm C, ≤ 1 ppm CO, ≤ 400 ppm CO₂, $\leq 0,1$ ppm NO); oxygen content between 18 and 21 % vol,
- purified oxygen (purity $\leq 99,5$ % vol O₂),
- purified hydrogen (and mixture containing hydrogen)
(purity ≤ 1 ppm C, ≤ 400 ppm CO₂).

4.5.2. *Calibration gases*

Gases having the following chemical compositions must be available: mixtures of:

- C₃H₈ and purified synthetic air (4.5.1),
- CO and purified nitrogen,
- CO₂ and purified nitrogen,
- NO and purified nitrogen.

(The amount of NO₂ contained in this calibration gas must not exceed 5 % of the NO content).

The true concentration of a calibration gas must be within $\pm 2\%$ of the stated figure.

The concentrations specified in Appendix 6 may also be obtained by means of a gas divider, diluting with purified N₂ or with purified synthetic air. The accuracy of the mixing device must be such that the concentrations of the diluted calibration gases may be determined to within $\pm 2\%$.

4.6. **Additional equipment**4.6.1. *Temperatures*

The temperatures indicated in Appendix 8 are measured with an accuracy of $\pm 1,5$ K.

▼ M9

- 4.6.2. *Pressure*
The atmospheric pressure must be measurable to within $\pm 0,1$ kPa.
- 4.6.3. *Absolute humidity*
The absolute humidity (H) must be measurable to within ± 5 %.
- 4.7. The exhaust gas-sampling system must be verified by the method described in section 3 of Appendix 7. The maximum permissible deviation between the quantity of gas introduced and the quantity of gas measured is 5 %.

5. **PREPARING THE TEST**5.1. **Adjustment of inertia simulators to the vehicle's translatory inertia**

An inertia simulator is used enabling a total inertia of the rotating masses to be obtained proportional to the reference mass within the following limits:

▼ M12

| Reference mass of vehicle RW (kg) | Equivalent inertia I (kg) |
|--------------------------------------|------------------------------|
| $RW \leq 480$ | 455 |
| $480 < RW \leq 540$ | 510 |
| $540 < RW \leq 595$ | 570 |
| $595 < RW \leq 650$ | 625 |
| $650 < RW \leq 710$ | 680 |
| $710 < RW \leq 765$ | 740 |
| $765 < RW \leq 850$ | 800 |
| $850 < RW \leq 965$ | 910 |
| $965 < RW \leq 1\ 080$ | 1\ 020 |
| $1\ 080 < RW \leq 1\ 190$ | 1\ 130 |
| $1\ 190 < RW \leq 1\ 305$ | 1\ 250 |
| $1\ 305 < RW \leq 1\ 420$ | 1\ 360 |
| $1\ 420 < RW \leq 1\ 530$ | 1\ 470 |
| $1\ 530 < RW \leq 1\ 640$ | 1\ 590 |
| $1\ 640 < RW \leq 1\ 760$ | 1\ 700 |
| $1\ 760 < RW \leq 1\ 870$ | 1\ 810 |
| $1\ 870 < RW \leq 1\ 980$ | 1\ 930 |
| $1\ 980 < RW \leq 2\ 100$ | 2\ 040 |
| $2\ 100 < RW \leq 2\ 210$ | 2\ 150 |
| $2\ 210 < RW \leq 2\ 380$ | 2\ 270 |
| $2\ 380 < RW \leq 2\ 610$ | 2\ 270 |
| $2\ 610 < RW$ | 2\ 270 |

If the corresponding equivalent inertia is not available on the dynamometer, the larger value closest to the vehicle reference mass will be used.

▼ M95.2. **Setting of dynamometer**

The load is adjusted according to methods described in 4.1.4.

The method used and the values obtained (equivalent inertia — characteristic adjustment parameter) must be recorded in the test report.

5.3. **Preconditioning of the vehicle**

- 5.3.1. For compression-ignition engine vehicles for the purpose of measuring particulates at most 36 hours and at least six hours before testing, the Part Two cycle described in Appendix 1 must be used. Three consecutive cycles must be driven. The dynamometer setting is as indicated in 5.1 and 5.2.

▼ M12

At the request of the manufacturer vehicles with positive ignition engine may be preconditioned with one Part I and two Part II driving cycles.

▼ M9

After this preconditioning specific for compression ignition engines and before testing, compression-ignition and positive ignition engine vehicles must be kept in a room in which the temperature remains relatively constant between 293 and 303 K (20 and 30 °C). This conditioning must be carried out for at least six hours and continue until the engine oil temperature and coolant, if any, are within ± 2 K of the temperature of the room.

If the manufacturer so requests, the test must be carried out not later than 30 hours after the vehicle has been run at its normal temperature.

▼ M14

- 5.3.1.1. For positive-ignition engined vehicles fuelled with LPG or NG or so equipped that they can be fuelled with either petrol or LPG or NG, between the tests on the first gaseous reference fuel and the second gaseous reference fuel, the vehicle shall be preconditioned before the test on the second reference fuel. This preconditioning is done on the second reference fuel by driving a preconditioning cycle consisting of one part one (urban part) and two times part two (extra-urban part) of the test cycle described in Appendix 1 to this Annex. On the manufacturer's request and with the agreement of the technical service this preconditioning cycle may be extended. The dynamometer setting shall be the one indicated in points 5.1 and 5.2 of this Annex.

▼ M9

- 5.3.2. The tyre pressures must be the same as that specified by the manufacturer and used for the preliminary road test for brake adjustment. The tyre pressures may be increased by up to 50 % from the manufacturer's recommended setting in the case of a two-roller dynamometer. The actual pressure used must be recorded in the test report.

6. PROCEDURE FOR BENCH TESTS

6.1. **Special conditions for carrying out the cycle**

- 6.1.1. During the test, the test cell temperature must be between 293 and 303 K (20 and 30 °C). The absolute humidity (H) of either the air in the test cell or the intake air of the engine must be such that:

$$5,5 \leq H \leq 12,2 \text{ g H}_2\text{O/kg dry air}$$

- 6.1.2. The vehicle must be approximately horizontal during the test so as to avoid any abnormal distribution of the fuel.

▼ M12

- 6.1.3. ► **M15** A current of air of variable speed is blown over the vehicle. ◀ The blower speed shall be such that, within the operating range of 10 km/h to at least 50 km/h, the linear velocity of the air at the blower outlet is within ± 5 km/h of the corresponding roller speed. The final selection of the blower shall have the following characteristics:

- Area: at least 0,2 m²
- Height of the lower edge above ground: approximately 20 cm
- Distance from the front of the vehicle: approximately 30 cm

As an alternative the blower speed shall be at least 6m/s (21,6 km/h). At the request of the manufacturer for special vehicles (e.g. vans, off-road) the height of the cooling fan can be modified.

- 6.1.4. During the test the speed is recorded against time or collected by the data acquisition system so that the correctness of the cycles performed can be assessed.

▼ M9

6.2. **Starting-up the engine**

- 6.2.1. The engine must be started up by means of the devices provided for this purpose according to the manufacturer's instructions, as incorporated in the driver's handbook of production vehicles.
- 6.2.2. ► **M15** The first cycle starts on the initiation of the engine start-up procedure. ◀

▼ M14

- 6.2.3. In the case of the use of LPG or NG as a fuel it is permissible that the engine is started on petrol and switched to LPG or NG after a predetermined period of time which cannot be changed by the driver.

▼ M9

- 6.3. **Idling**
- 6.3.1. *Manual-shift or semi-automatic gearbox*

▼ M12

See Appendix tables III.1.2 and III.1.3.

▼ M9

- 6.3.2. *Automatic-shift gearbox*
- After initial engagement the selector must not be operated at any time during the test except as in the case specified in 6.4.3 or if the selector can actuate the overdrive, if any.
- 6.4. **Accelerations**
- 6.4.1. Accelerations must be so performed that the rate of acceleration is as constant as possible throughout the phase.
- 6.4.2. If an acceleration cannot be carried out in the prescribed time, the extra time required is, if possible, deducted from the time allowed for changing gear, but otherwise from the subsequent steady-speed period.
- 6.4.3. *Automatic-shift gearboxes*
- If an acceleration cannot be carried out in the prescribed time, the gear selector is operated in accordance with requirements for manual-shift gearboxes.
- 6.5. **Deceleration**
- 6.5.1. All decelerations of the elementary urban cycle (Part One) are effected by removing the foot completely from the accelerator, the clutch remaining engaged. The clutch is disengaged, without use of the gear lever, at a speed of 10 km/h.
- All the decelerations of the extra-urban cycle (Part Two) are effected by removing the foot completely from the accelerator, the clutch remaining engaged. The clutch is disengaged, without use of the gear lever, at a speed of 50 km/h for the last deceleration.
- 6.5.2. If the period of deceleration is longer than that prescribed for the corresponding phase, the vehicle's brakes are used to enable the timing of the cycle to be complied with.
- 6.5.3. If the period of deceleration is shorter than that prescribed for the corresponding phase, the timing of the theoretical cycle is restored by constant speed or idling period merging into the following operation.
- 6.5.4. At the end of the deceleration period (halt of the vehicle on the rollers) of the elementary urban cycle (Part One) the gears are placed in neutral and the clutch engaged.
- 6.6. **Steady speeds**
- 6.6.1. Pumping or the closing of the throttle must be avoided when passing from acceleration to the following steady speed.
- 6.6.2. Periods of constant speed are achieved by keeping the accelerator position fixed.

▼ M9

7. GAS AND PARTICULATE SAMPLING AND ANALYSIS

▼ M107.1. **Sampling****▼ M15**

Sampling begins (BS) before or at the initiation of the engine start-up procedure and ends on conclusion of the final idling period in the extra-urban cycle (part two, end of sampling (ES)) or, in the case of test type VI of the final idling period of the last elementary cycle (part one).

▼ M97.2. **Analysis**

7.2.1. The exhaust gases contained in the bag must be analysed as soon as possible and in any event not later than 20 minutes after the end of the test cycle. The spent particulate filters must be taken to the chamber no later than one hour after conclusion of the test on the exhaust gases and must there be conditioned for between two and 36 hours and then be weighed.

7.2.2. Prior to each sample analysis the analyser range to be used for each pollutant must be set to zero with the appropriate zero gas.

7.2.3. The analysers are then set to the calibration curves by means of span gases of nominal concentrations of 70 to 100 % of the range.

7.2.4. The analysers' zeros are then rechecked. If the reading differs by more than 2 % of range from that set in 7.2.2, the procedure is repeated.

7.2.5. The samples are then analyzed.

7.2.6. After the analysis, zero and span points are rechecked using the same gases. If these rechecks are within 2 % of those in 7.2.3, the analysis is considered acceptable.

7.2.7. At all points in this section the flow-rates and pressures of the various gases must be the same as those used during calibration of the analysers.

7.2.8. The figure adopted for the concentration of each pollutant measured in the gases is that read off after stabilization on the measuring device. Hydrocarbon mass emissions of compression-ignition engines are calculated from the integrated HFID reading, corrected for varying flow if necessary as shown in Appendix 5.

8. DETERMINATION OF THE QUANTITY OF GASEOUS AND PARTICULATE POLLUTANTS EMITTED

8.1. **The volume considered**

The volume to be considered must be corrected to conform to the conditions of 101,33 kPa and 273,2 K.

8.2. **Total mass of gaseous and particulate pollutants emitted**

The mass m of each gaseous pollutant emitted by the vehicle during the test is determined by obtaining the product of the volumetric concentration and the volume of the gas in question, with due regard to the following densities under the abovementioned reference conditions:

▼ M14

In the case of carbon monoxide (CO): $d = 1.25 \text{ g/l}$

In the case of hydrocarbons:

for petrol ($\text{CH}_{1.85}$) $d = 0.619 \text{ g/l}$

for diesel ($\text{CH}_{1.86}$) $d = 0.619 \text{ g/l}$

for LPG ($\text{CH}_{2.525}$) $d = 0.649 \text{ g/l}$

for NG (CH_4) $d = 0.714 \text{ g/l}$

In the case of nitrogen oxides (NO_2): $d = 2.05 \text{ g/l}$

▼M9

The mass m of particulate pollutant emissions from the vehicle during the test is defined by weighing the mass of particulates collected by the two filters, m_1 by the first filter, m_2 by the second filter:

- if $0,95 (m_1 + m_2) \leq m_1$, $m = m_1$,
- if $0,95 (m_1 + m_2) > m_1$, $m = m_1 + m_2$,
- if $m_2 > m_1$, the test is cancelled.

Appendix 8 gives the calculations, followed by examples, used in determining the mass emissions of gaseous and particulate pollutants.

▼ **M9***Appendix 1***BREAKDOWN OF THE OPERATING CYCLE USED FOR THE TYPE I TEST**

1. OPERATING CYCLE
- 1.1. The operating cycle, made up of a Part One (urban cycle) and Part Two (extra-urban cycle), is illustrated at Figure III.1.1.
2. ELEMENTARY URBAN CYCLE (PART ONE)
- See Figure III.1.2 and Table III.1.2.

2.1. **Breakdown by phases**

| | Time (s) | % | |
|---|----------|------|--------|
| Idling | 60 | 30,8 | } 35,4 |
| Idling, vehicle moving, clutch engaged on one combination | 9 | 4,6 | |
| Gear-changing | 8 | 4,1 | |
| Accelerations | 36 | 18,5 | |
| Steady-speed periods | 57 | 29,2 | |
| Decelerations | 25 | 12,8 | |
| | 195 | 100 | |

2.2. **Breakdown by use of gears**

| | Time (s) | % | |
|---|----------|------|--------|
| Idling | 60 | 30,8 | } 35,4 |
| Idling, vehicle moving, clutch engaged on one combination | 9 | 4,6 | |
| Gear-changing | 8 | 4,1 | |
| First gear | 24 | 12,3 | |
| Second gear | 53 | 27,2 | |
| Third gear | 41 | 21 | |
| | 195 | 100 | |

2.3. **General information**

Average speed during test: 19 km/h.
 Effective running time: 195 seconds.
 Theoretical distance covered per cycle: 1,013 km.
 Equivalent distance for the four cycles: 4,052 km.

▼M15

Figure III.1.1

Operating cycle for the Type I test

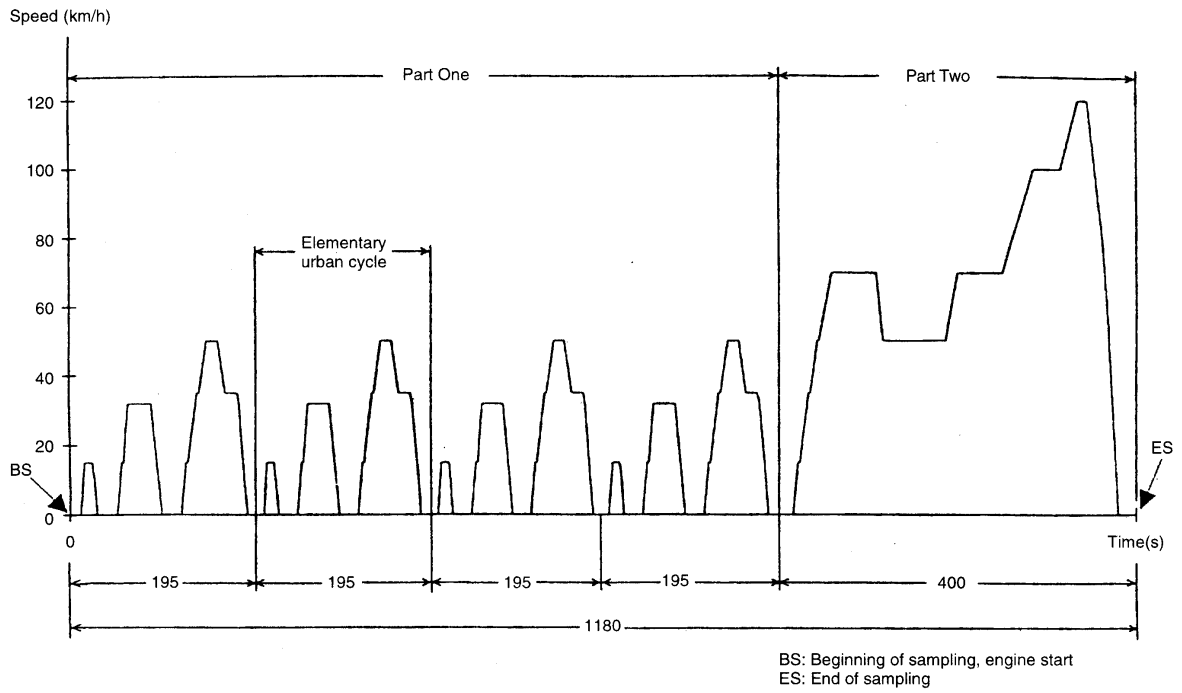

Table III.1.2

Operating cycle on the chassis dynamometer (Part One)

| No of operation | Operation | Phase | Acceleration (m/s ²) | Speed (km/h) | Duration of each | | Cumulative time (s) | Gear to be used in the case of a manual gearbox | |
|-----------------|---------------------------------|-------|----------------------------------|--------------|------------------|-----------|---------------------|---|--------------------|
| | | | | | Operation (s) | Phase (s) | | | |
| 1 | Idling | 1 | | | 11 | 11 | 11 | 6 s PM + 5 s K ₁ (*) | |
| 2 | Acceleration | 2 | 1,04 | 0-15 | 4 | 4 | 15 | | |
| 3 | Steady speed | 3 | | 15 | 9 | 8 | 23 | | |
| 4 | Deceleration | 4 | -0,69 | 15-10 | 2 | 5 | 25 | | |
| 5 | Deceleration, clutch disengaged | | 3 | | -0,92 | | 10-0 | | 21 |
| 6 | Idling | 5 | | | 5 | 21 | 49 | | K ₁ (*) |
| 7 | Acceleration | 6 | 0,83 | 0-15 | 2 | 12 | 54 | | |
| 8 | Gear change | 6 | | 15-32 | 5 | 5 | 56 | | 2 |
| 9 | Acceleration | | 7 | | 0,94 | | 32 | | |
| 10 | Steady speed | 7 | | 32-10 | 8 | 11 | 85 | | 2 |
| 11 | Deceleration | | 8 | | -0,75 | | 10-0 | | |
| 12 | Deceleration, clutch disengaged | 8 | | | 3 | 3 | 96 | | K ₂ (*) |
| 13 | Idling | 9 | -0,92 | 10-0 | 5 | 21 | 117 | | |
| 14 | Acceleration | 9 | | 0-15 | 2 | 2 | 122 | | 1 |
| 15 | Gear change | | 10 | | 0-15 | | 9 | | |
| 16 | Acceleration | 10 | 0,62 | 15-35 | 2 | 8 | 133 | | 2 |
| 17 | Gear change | | 11 | | 0,52 | | 35-50 | | |
| 18 | Acceleration | 11 | | 50 | 8 | 12 | 143 | | 3 |
| 19 | Steady speed | | 12 | | -0,52 | | 50-35 | | |
| 20 | Deceleration | 12 | | 35-10 | 13 | 13 | 163 | | 3 |
| 21 | Steady speed | | 14 | | -0,92 | | 10-0 | | |
| 22 | Gear change | 14 | | 32-10 | 2 | 12 | 178 | 2 | |
| 23 | Deceleration | | 7 | | -0,86 | | 185 | | |
| 24 | Deceleration, clutch disengaged | 15 | | 10-0 | 3 | 7 | 188 | K ₂ (*) | |
| 25 | Idling | | 7 | | -0,92 | | 195 | | |

(*) PM = gearbox in neutral, clutch engaged.
 K₁, K₂ = first or second gear engaged, clutch disengaged.

▼M9

Figure III.1.2

Elementary urban cycle for the type I test

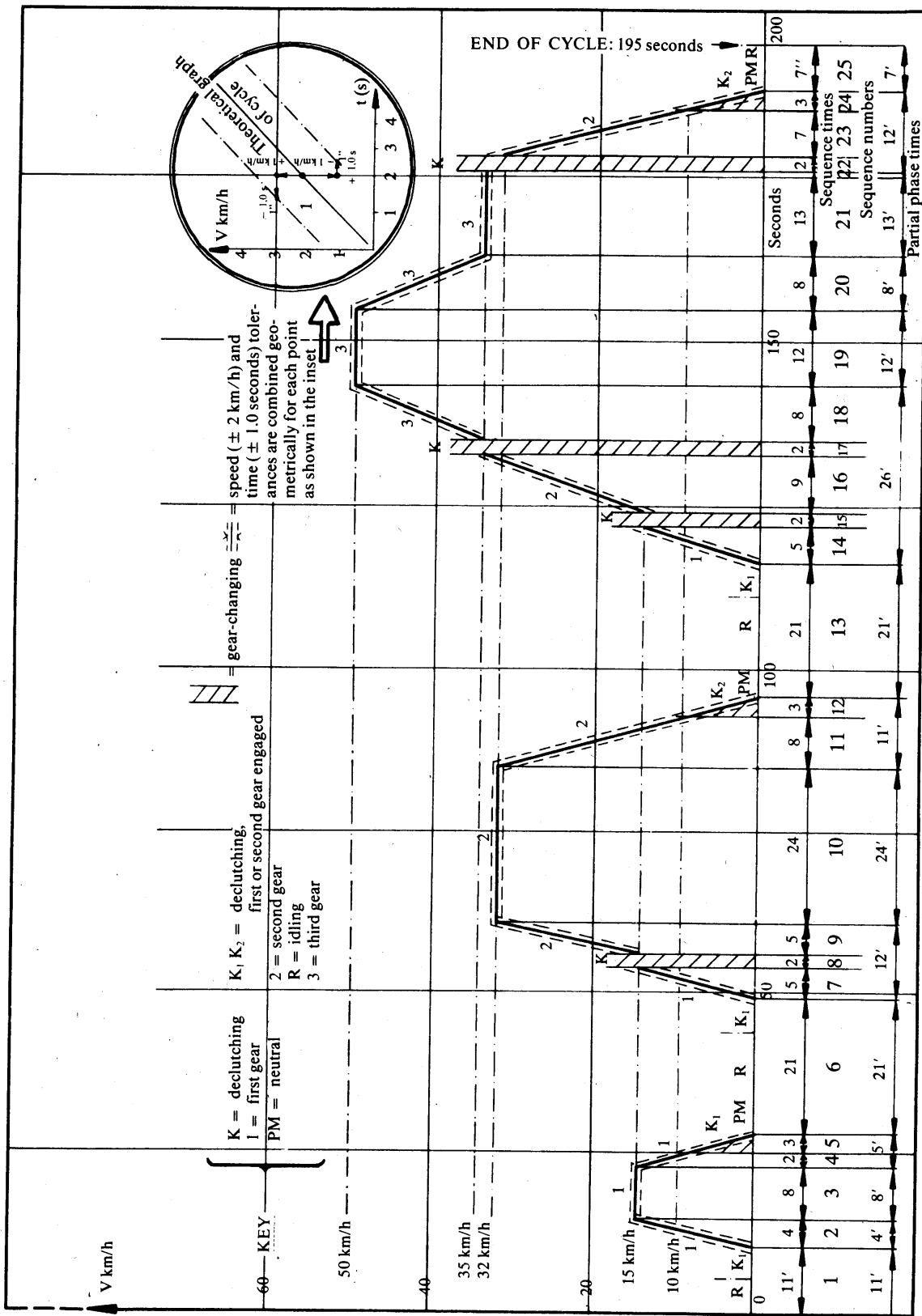

▼ **M9**

3. EXTRA - URBAN CYCLE (Part Two)

See Figure III.1.3 and Table III.1.3

3.1. **Breakdown by phases**

| | Time (s) | % |
|--|-------------|------|
| Idling | 20 | 5,0 |
| Idling, vehicle moving, clutch engaged on one combination | 20 | 5,0 |
| Gear-changing | 6 | 1,5 |
| Accelerations | 103 | 25,8 |
| Steady-speed periods | 209 | 52,2 |
| Decelerations | 42 | 10,5 |
| | 400 | 100 |

3.2. **Breakdown by use of gears**

| | Time (s) | % |
|--|-------------|------|
| Idling | 20 | 5,0 |
| Idling, vehicle moving, clutch engaged on one combination | 20 | 5,0 |
| Gear-changing | 6 | 1,5 |
| First gear | 5 | 1,3 |
| Second gear | 9 | 2,2 |
| Third gear | 8 | 2,0 |
| Fourth gear | 99 | 24,8 |
| Fifth gear | 233 | 58,2 |
| | 400 | 100 |

3.3. **General information**

Average speed during test: 62,6 km/h.
 Effective running time: 400 seconds.
 Theoretical distance covered per cycle: 6,955 km.
 Maximal speed: 120 km/h.
 Maximal acceleration: 0,833 m/s².
 Maximal deceleration: - 1,389 m/s².

Table III.1.3
Extra-urban cycle (Part Two) for the type I test

| No of operation | Operation | Phase | Acceleration (m/s ²) | Speed (km/h) | Duration of each | | Cumulative time (s) | Gear to be used in the case of a manual gearbox |
|-----------------|---------------------------------|-------|----------------------------------|--------------|------------------|-----------|---------------------|---|
| | | | | | Operation (s) | Phase (s) | | |
| 1 | Idling | 1 | | | 20 | 20 | 20 | K1 (*) |
| 2 | Acceleration | 2 | 0,83 | 0-15 | 5 | 41 | 25 | 1 |
| 3 | Gear change | | | | 2 | | 27 | — |
| 4 | Acceleration | 3 | 0,62 | 15-35 | 9 | 41 | 36 | 2 |
| 5 | Gear change | | | | 2 | | 38 | — |
| 6 | Acceleration | 4 | 0,52 | 35-30 | 8 | 41 | 46 | 3 |
| 7 | Gear change | | | | 2 | | 48 | — |
| 8 | Acceleration | 5 | 0,43 | 50-70 | 13 | 41 | 61 | 4 |
| 9 | Steady speed | | | | 50 | | 111 | 5 |
| 10 | Deceleration | 6 | -0,69 | 70-50 | 8 | 41 | 119 | 4 s.5 + 4 s.4 |
| 11 | Steady speed | | | | 69 | | 188 | 4 |
| 12 | Acceleration | 7 | 0,43 | 50-70 | 13 | 41 | 201 | 4 |
| 13 | Steady speed | | | | 50 | | 251 | 5 |
| 14 | Acceleration | 8 | 0,24 | 70-100 | 35 | 41 | 286 | 5 |
| 15 | Steady speed | | | | 30 | | 316 | 5 (**) |
| 16 | Acceleration | 9 | 0,28 | 100-120 | 20 | 41 | 336 | 5 (**) |
| 17 | Steady speed | | | | 10 | | 346 | 5 (**) |
| 18 | Deceleration | 10 | -0,69 | 120-80 | 16 | 41 | 362 | 5 (**) |
| 19 | Deceleration | | | | 8 | | 370 | 5 (**) |
| 20 | Deceleration, clutch disengaged | 11 | -1,04 | 80-50 | | 41 | | |
| 21 | Idle | | | | 10 | | 380 | K _s (*) |
| | | 13 | -1,39 | 50-0 | 20 | | 400 | PM (*) |

(*) PM = gearbox in neutral, clutch engaged.

First or fifth gear engaged, clutch disengaged.

(**) Additional gears can be used according to manufacturer recommendations if the vehicle is equipped with a transmission with more than five gears.

▼ M9

Figure III.1.3
Extra-urban cycle (Part Two) for the type I test

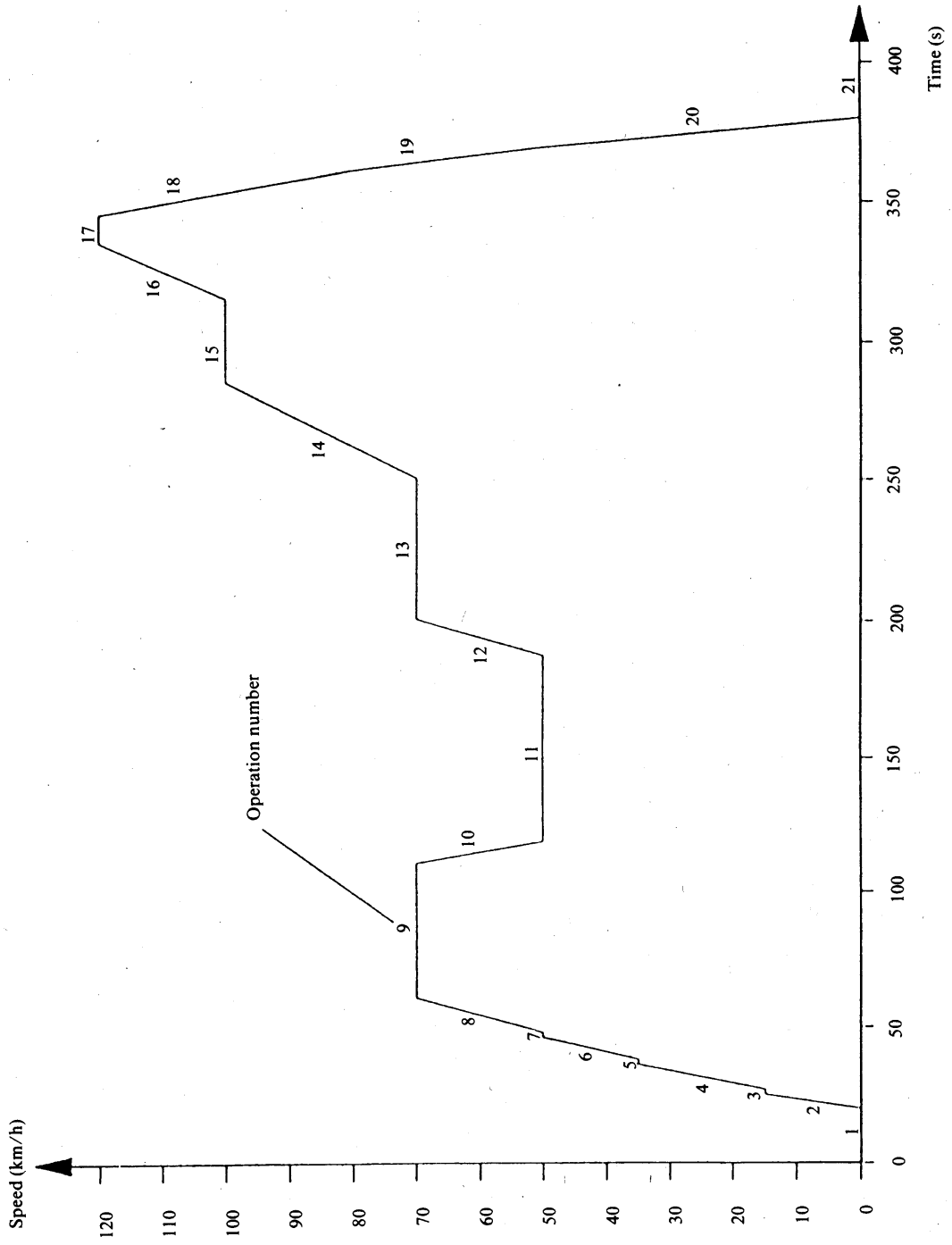

▼ M15

▼ M9

Appendix 2

CHASSIS DYNAMOMETER

1. DEFINITION OF A CHASSIS DYNAMOMETER WITH FIXED LOAD CURVE

1.1. Introduction

In the event that the total resistance to progress on the road is not reproduced on the chassis dynamometer between speeds of 10 and ► M12 120 km/h ◀, it is recommended to use a chassis dynamometer having the characteristics defined below.

1.2. Definition

1.2.1. The chassis dynamometer may have one or two rollers.

The front roller drives, directly or indirectly, the inertia masses and the power absorption device.

▼ M12

1.2.2. The load absorbed by the brake and the chassis dynamometer internal frictional effects from the speed of 0 to 120 km/h is as follows:

$$F = (a + b \cdot V^2) \pm 0,1 \cdot F_{80} \text{ (without being negative)}$$

where:

F = total load absorbed by the chassis dynamometer (N)

a = value equivalent to rolling resistance (N)

b = value equivalent to coefficient of air resistance (N/(km/h)²)

V = speed (km/h)

F₈₀ = load at the speed of 80 km/h (N).

▼ M9

2. METHOD OF CALIBRATING THE DYNAMOMETER

2.1. Introduction

▼ M12

This Appendix describes the method to be used to determine the load absorbed by a dynamometer brake.

The load absorbed comprises the load absorbed by frictional effects and the load absorbed by the power-absorption device.

▼ M9

The dynamometer is brought into operation beyond the range of test speeds. The device used for starting up the dynamometer is then disconnected: the rotational speed of the driven roller decreases.

The kinetic energy of rollers is dissipated by the power-absorption unit and by the frictional effects. This method disregards variations in the roller's internal frictional effects caused by rollers with or without the vehicle. The frictional effects of the rear roller shall be disregarded when this is free.

2.2. ► M12 Calibrating the load indicator to 80 km/h as a function of the load absorbed ◀

The following procedure is used (see also Figure III.2.2.2).

2.2.1. Measure the rotational speed of the roller if this has not already been done. A fifth wheel, a revolution counter or some other method may be used.

2.2.2. Place the vehicle on the dynamometer or devise some other method of starting up the dynamometer.

2.2.3. Use the fly-wheel or any other system of inertia simulation for the particular inertia class to be used.

▼ **M12**

Figure III.2.2.2.

Diagram illustrating the load of the chassis dynamometer

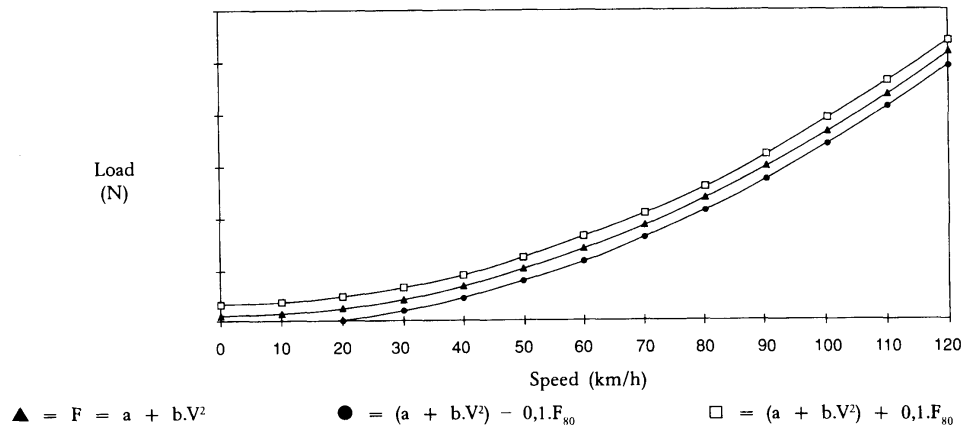
▼ **M9**

2.2.4. Bring the dynamometer to a speed of 80 km/h.

▼ **M12**2.2.5. Note the load indicated F_i (N).▼ **M9**

2.2.6. Bring the dynamometer to a speed of 90 km/h.

2.2.7. Disconnect the device used to start up the dynamometer.

2.2.8. Note the time taken by the dynamometer to pass from a speed of 85 km/h to a speed of 75 km/h.

2.2.9. Set the power-absorption device at a different level.

2.2.10. The requirements of 2.2.4 to 2.2.9 must be repeated sufficiently often to cover the range of ► **M12** load ◀ used.▼ **M12**

2.2.11. Calculate the load absorbed, using the formula

$$F = \frac{M_i \cdot \Delta V}{t}$$

where

F = load absorbed in N

 M_i = equivalent inertia in kilograms (excluding the inertial effects of free rear roller) ΔV = speed deviation in m/s (10 km/h = 2,775 m/s)

t = time taken by the roller to pass from 85 to 75 km/h.

2.2.12. Figure III.2.2.12 shows the load indicated at 80 km/h in terms of the load absorbed at 80 km/h.

▼ **M12**

Figure III.2.2.12

Load indicated at 80 km/h in terms of load absorbed at 80 km/h

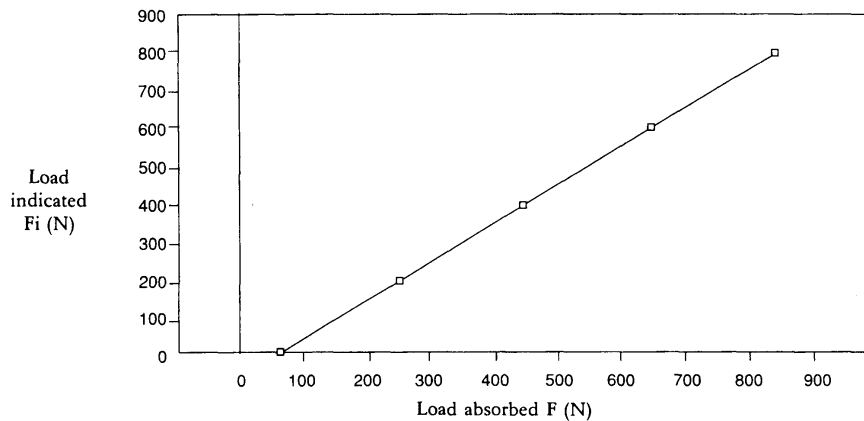
▼ **M9**

2.2.13. The operation described in 2.2.3 to 2.2.12 must be repeated for all inertia classes to be used.

2.3. ► **M12** Calibration of the load indicator as a function of the absorbed load for other speeds ◀

The procedures described in 2.2 must be repeated as often as necessary for the chosen speeds.

2.4. Verification of the ► **M12** load ◀ -absorption curve of the dynamometer from a reference setting at a speed of 80 km/h

2.4.1. Place the vehicle on the dynamometer or devise some other method of starting up the dynamometer.

2.4.2. Adjust the dynamometer to the absorbed ► **M12** load ◀ at 80 km/h.

▼ **M12**

2.4.3. Note the load absorbed at 120, 100, 80, 60, 40 and 20 km/h.

▼ **M9**

► **M12** 2.4.4. Draw the curve $F(V)$ ◀ and verify that it corresponds to the requirements of 1.2.2.

2.4.5. Repeat the procedure set out in 2.4.1 to 2.4.4 for other values of ► **M12** load F ◀ at 80 km/h and for other values of inertia.

2.5. The same procedure must be used for force or torque calibration.

3. SETTING OF THE DYNAMOMETER

▼ **M12**

3.1. Setting methods

The dynamometer setting may be carried out at a constant speed of 80 km/h in accordance with the requirements of Appendix 3.

▼ **M9**

3.1.1. Introduction

This method is not a preferred method and must be used only with fixed load curve shape dynamometers for determination of load setting at 80 km/h and cannot be used for vehicles with compression-ignition engines.

3.1.2. Test instrumentation

The vacuum (or absolute pressure) in the intake manifold vehicle is measured to an accuracy of $\pm 0,25$ kPa. It must be possible to record this reading continuously or at intervals of no more than one second. The speed must be recorded continuously with a precision of $\pm 0,4$ km/h.

▼M9

- 3.1.3. *Road test*
- 3.1.3.1. Ensure that the requirements of section 4 of Appendix 3 are met.
- 3.1.3.2. Drive the vehicle at a steady speed of 80 km/h recording speed and vacuum (or absolute pressure) in accordance with the requirements of 3.1.2.
- 3.1.3.3. Repeat procedure set out in 3.1.3.2 three times in each direction. All six runs must be completed within four hours.
- 3.1.4. *Data reduction and acceptance criteria*
- 3.1.4.1. Review results obtained in accordance with 3.1.3.2 and 3.1.3.3 (speed must not be lower than 79,5 km/h or greater than 80,5 km/h for more than one second). For each run, read vacuum level at one-second intervals, calculate mean vacuum (\bar{v}) and standard deviation(s). This calculation must consist of no less than 10 readings of vacuum.
- 3.1.4.2. The standard deviation must not exceed 10 % of mean (\bar{v}) for each run.
- 3.1.4.3. Calculate the mean value (\bar{v}) for the six runs (three runs in each direction).
- 3.1.5. *Dynamometer setting*
- 3.1.5.1. *Preparation*
- Perform the operations specified in 5.1.2.2.1 to 5.1.2.2.4 of Appendix 3.
- 3.1.5.2. *Setting*
- After warm-up, drive the vehicle at a steady speed of 80 km/h and adjust dynamometer load to reproduce the vacuum reading (v) obtained in accordance with 3.1.4.3. Deviation from this reading must be no greater than 0,25 kPa. The same instruments are used for this exercise as were used during the road test.

▼M12

- 3.2. **Alternative method**
- With the manufacturer's agreement the following method may be used:
- 3.2.1. The brake is adjusted so as to absorb the load exerted at the driving wheels at a constant speed of 80 km/h in accordance with the following table:

| Reference mass of vehicles | Equivalent inertia | Power and load absorbed by the dynamometer at 80 km/h | | Coefficients | |
|----------------------------|--------------------|---|-----|--------------|-----------------------|
| | | | | a | b |
| RW (kg) | kg | kW | N | N | N/(km/h) ² |
| RW ≤ 480 | 455 | 3,8 | 171 | 3,8 | 0,0261 |
| 480 < RW ≤ 540 | 510 | 4,1 | 185 | 4,2 | 0,0282 |
| 540 < RW ≤ 595 | 570 | 4,3 | 194 | 4,4 | 0,0296 |
| 595 < RW ≤ 650 | 625 | 4,5 | 203 | 4,6 | 0,0309 |
| 650 < RW ≤ 710 | 680 | 4,7 | 212 | 4,8 | 0,0323 |
| 710 < RW ≤ 765 | 740 | 4,9 | 221 | 5,0 | 0,0337 |
| 765 < RW ≤ 850 | 800 | 5,1 | 230 | 5,2 | 0,0351 |
| 850 < RW ≤ 965 | 910 | 5,6 | 252 | 5,7 | 0,0385 |
| 965 < RW ≤ 1 080 | 1 020 | 6,0 | 270 | 6,1 | 0,0412 |
| 1 080 < RW ≤ 1 190 | 1 130 | 6,3 | 284 | 6,4 | 0,0433 |
| 1 190 < RW ≤ 1 305 | 1 250 | 6,7 | 302 | 6,8 | 0,0460 |
| 1 305 < RW ≤ 1 420 | 1 360 | 7,0 | 315 | 7,1 | 0,0481 |
| 1 420 < RW ≤ 1 530 | 1 470 | 7,3 | 329 | 7,4 | 0,0502 |
| 1 530 < RW ≤ 1 640 | 1 590 | 7,5 | 338 | 7,6 | 0,0515 |
| 1 640 < RW ≤ 1 760 | 1 700 | 7,8 | 351 | 7,9 | 0,0536 |
| 1 760 < RW ≤ 1 870 | 1 810 | 8,1 | 365 | 8,2 | 0,0557 |

▼ **M12**

| Reference mass of vehicles | Equivalent inertia | Power and load absorbed by the dynamometer at 80 km/h | | Coefficients | |
|----------------------------|--------------------|---|-----|--------------|-----------------------|
| | | | | a | b |
| RW (kg) | kg | kW | N | N | N/(km/h) ² |
| 1 870 < RW ≤ 1 980 | 1 930 | 8,4 | 378 | 8,5 | 0,0577 |
| 1 980 < RW ≤ 2 100 | 2 040 | 8,6 | 387 | 8,7 | 0,0591 |
| 2 100 < RW ≤ 2 210 | 2 150 | 8,8 | 396 | 8,9 | 0,0605 |
| 2 210 < RW ≤ 2 380 | 2 270 | 9,0 | 405 | 9,1 | 0,0619 |
| 2 380 < RW ≤ 2 610 | 2 270 | 9,4 | 423 | 9,5 | 0,0646 |
| 2 610 < RW | 2 270 | 9,8 | 441 | 9,9 | 0,0674 |

- 3.2.2. In the case of vehicles, other than passenger cars, with a reference mass of more than 1 700 kg, or vehicles with permanent all-wheel drive, the power values given in the table set out in 3.2.1 are multiplied by the factor 1,3.

▼ M9*Appendix 3***RESISTANCE TO PROGRESS OF A VEHICLE — MEASUREMENT METHOD ON THE ROAD — SIMULATION ON A CHASSIS DYNAMOMETER**

1. OBJECT OF THE METHODS

The object of the methods defined below is to measure the resistance to progress of a vehicle at stabilized speeds on the road and to simulate this resistance on a dynamometer, in accordance with section 4.1.5 of Annex III.

2. DEFINITION OF THE ROAD

The road must be level and sufficiently long to enable the measurements specified below to be made. The slope must be constant to within $\pm 0,1$ % and must not exceed 1,5 %.

3. ATMOSPHERIC CONDITIONS

3.1. **Wind**

Testing must be limited to wind speeds averaging less than 3 m/s with peak speeds less than 5 m/s. In addition, the vector component of the wind speed across the test road must be less than 2 m/s. Wind velocity must be measured 0,7 m above the road surface.

3.2. **Humidity**

The road must be dry.

3.3. **Pressure — Temperature**

Air density at the time of the test must not deviate by more than $\pm 7,5$ % from the reference conditions, $p = 100$ kPa and $T = 293,2$ K.

4. VEHICLE PREPARATION

▼ M124.1. **Selection of the test vehicle**

If not all variants of a vehicle type⁽¹⁾ are measured the following criteria for the selection of the test vehicle shall be used.

4.1.1. Body

If there are different types of body, the worst one in terms of aerodynamics shall be chosen. The manufacturer shall provide appropriate data for the selection.

4.1.2. Tyres

The widest tyre shall be chosen. If there are more than three tyre sizes, the widest minus one shall be chosen.

4.1.3. Testing mass

The testing mass shall be the reference mass of the vehicle with the highest inertia range.

4.1.4. Engine

The test vehicle shall have the largest heat exchanger(s).

4.1.5. Transmission

A test shall be carried out with each type of the following transmissions:

- front wheel drive
- rear wheel drive
- full time 4×4

⁽¹⁾ According to Directive 70/156/EEC.

▼ **M12**

- part time 4 × 4
- automatic gear box
- manual gear box

▼ **M9**► **M12** 4.2. ◀ **Running in**

The vehicle must be in normal running order and adjustment after having been run-in for at least 3 000 km. The tyres must be run in at the same time as the vehicle or have a tread depth within 90 and 50 % of the initial tread depth.

► **M12** 4.3. ◀ **Verifications**

The following checks must be made in accordance with the manufacturer's specifications for the use considered:

- wheels, wheel trims, tyres (make, type, pressure),
- front axle geometry,
- brake adjustment (elimination of parasitic drag),
- lubrication of front and rear axles,
- adjustment of the suspension and vehicle level, etc.

► **M12** 4.4. ◀ **Preparation for the test**

- **M12** 4.4.1. ◀ The vehicle is loaded to its reference mass. The level of the vehicle must be that obtained when the centre of gravity of the load is situated midway between the 'R' points of the front outer seats and on a straight line passing through those points.
- **M12** 4.4.2. ◀ In the case of road tests, the windows of the vehicle must be closed. Any covers of air climatization systems, headlamps, etc, must be in the non-operating position.
- **M12** 4.4.3. ◀ The vehicle must be clean.
- **M12** 4.4.4. ◀ Immediately prior to the test the vehicle is brought to normal running temperature in an appropriate manner.

5. METHODS

5.1. **Method of energy variation during coast-down**5.1.1. *On the road*

5.1.1.1. Test equipment and error:

- time must be measured to an error lower than 0,1 second,
- speed must be measured to an error lower than 2 %.

5.1.1.2. Test procedure

- 5.1.1.2.1. Accelerate the vehicle to a speed 10 km/h greater than the chosen test speed V.
- 5.1.1.2.2. Place the gearbox in 'neutral' position.
- 5.1.1.2.3. Measure the time (t_1) taken for the vehicle to decelerate from $V_2 = V + V$ km/h to $V_1 = V - V$ km/h with $V \leq 5$ km/h
- 5.1.1.2.4. Perform the same test in the opposite direction: t_2
- 5.1.1.2.5. Take the average \bar{T} of the two times t_1 and t_2 .
- 5.1.1.2.6. Repeat these tests several times such that the statistical accuracy (p) of the average

$$T = \frac{1}{n} \sum_{i=1}^n T_i \text{ is not more than } 2 \% (p \leq 2 \%)$$

The statistical accuracy (p) is defined by:

$$p = \frac{t \cdot s}{\sqrt{n}} \cdot \frac{100}{\bar{T}}$$

where:

t = coefficient given by the table below,

▼ **M9**

$$s = \text{standard deviation, } s = \sqrt{\frac{\sum_{i=1}^n (T_i - \bar{T})^2}{n - 1}}$$

n = number of tests,

| | | | | | | | | | | | | |
|----------------------|-----|------|------|------|------|------|------|------|------|------|------|------|
| n | 4 | 5 | 6 | 7 | 8 | 9 | 10 | 11 | 12 | 13 | 14 | 15 |
| t | 3,2 | 2,8 | 2,6 | 2,5 | 2,4 | 2,3 | 2,3 | 2,2 | 2,2 | 2,2 | 2,2 | 2,2 |
| $\frac{t}{\sqrt{n}}$ | 1,6 | 1,25 | 1,06 | 0,94 | 0,85 | 0,77 | 0,73 | 0,66 | 0,64 | 0,61 | 0,59 | 0,57 |

5.1.1.2.7. Calculate the power by the formula:

▼ **M15**

$$P = \frac{M V \Delta V}{500 T}$$

▼ **M9**

where:

P = is expressed in kw,

V = speed of the test in m/s,

ΔV = speed deviation from speed V, in m/s,

M = reference mass in kg,

T = time in seconds.

▼ **M12**

5.1.1.2.8. The power (P) determined on the track shall be corrected to the reference ambient conditions as follows:

$$P_{\text{corrected}} = K \cdot P_{\text{measured}}$$

$$K = \frac{R_R}{R_T} \cdot [1 + K_R(t - t_0)] + \frac{R_{\text{AERO}}}{R_T} \cdot \frac{(\rho_0)}{\rho}$$

where

R_R = rolling resistance at speed V

R_{AERO} = aerodynamic drag at speed V

R_T = total driving resistance = $R_R + R_{\text{AERO}}$

▼ **M14**

K_R = temperature correction factor of rolling resistance, taken to be equal to: $8,64 \times 10^{-3}/^{\circ}\text{C}$ or the manufacturer's correction factor that is approved by the authority

▼ **M12**

t = road test ambient temperature in $^{\circ}\text{C}$

t_0 = reference ambient temperature = 20°C

ρ = air density at the test conditions

ρ_0 = air density at the reference conditions (20°C , 100 kPa)

The ratios R_R/R_T and R_{AERO}/R_T shall be specified by the vehicle manufacturer on the basis of the data normally available to the company.

If these values are not available, subject to the agreement of the manufacturer and the technical service concerned, the figures for the rolling/total resistance ratio given by the following formula may be used:

$$\frac{R_R}{R_T} = a \cdot M + b$$

where:

M = vehicle mass in kg

▼ **M14**

and for each speed the coefficients a and b are shown in the following table:

▼ M14

| V (km/h) | a | b |
|----------|-----------------------|------|
| 20 | $7,24 \times 10^{-5}$ | 0,82 |
| 40 | $1,59 \times 10^{-4}$ | 0,54 |
| 60 | $1,96 \times 10^{-4}$ | 0,33 |
| 80 | $1,85 \times 10^{-4}$ | 0,23 |
| 100 | $1,63 \times 10^{-4}$ | 0,18 |
| 120 | $1,57 \times 10^{-4}$ | 0,14 |

▼ M9

- 5.1.2. *On the dynamometer*
- 5.1.2.1. Measurement equipment and accuracy
The equipment must be identical to that used on the road.
- 5.1.2.2. Test procedure
- 5.1.2.2.1. Install the vehicle on the test dynamometer.
- 5.1.2.2.2. Adjust the tyre pressure (cold) of the driving wheels as required by the dynamometer.
- 5.1.2.2.3. Adjust the equivalent inertia of the dynamometer.
- 5.1.2.2.4. Bring the vehicle and dynamometer to operating temperature in a suitable manner.
- 5.1.2.2.5. Carry out the operations specified in 5.1.1.2 with the exception of 5.1.1.2.4 and 5.1.1.2.5 and with replacing M by I in the formula set out in 5.1.1.2.7.

▼ M12

- 5.1.2.2.6. Adjust the brake to reproduce the corrected power (Section 5.1.1.2.8) and to take into account the difference between the vehicle mass (M) on the track and the equivalent inertia test mass (I) to be used. This may be done by calculating the mean corrected road coast down time from V_2 to V_1 and reproducing the same time on the dynamometer by the following relationship:

$$T_{\text{corrected}} = \frac{T_{\text{measured}}}{K} \cdot \frac{I}{M}$$

K = specified in 5.1.1.2.8.

- 5.1.2.2.7. The power P_a to be absorbed by the bench should be determined in order to enable the same power (Section 5.1.1.2.8) to be reproduced for the same vehicle on different days.

▼ M95.2. **Torque measurement method at constant speed**

- 5.2.1. *On the road*
- 5.2.1.1. Measurement equipment and error
Torque measurement must be carried out with an appropriate measuring device accurate to within 2 %.
Speed measurement must be accurate to within 2 %.
- 5.2.1.2. Test procedure
- 5.2.1.2.1. Bring the vehicle to the chosen stabilized speed V.

▼ M12

- 5.2.1.2.2. Record the torque $C_{(t)}$ and speed over a period of least 20 s. The accuracy of the data recording system shall be at least ± 1 Nm for the torque and $\pm 0,2$ km/h for the speed.

▼ M9

- 5.2.1.2.3. Differences in torque $C_{(t)}$ and speed relative to time must not exceed 5 % for each second of the measurement period.
- 5.2.1.2.4. The torque C is the average torque derived from the following formula:

▼ M9

$$C_{ti} = \frac{1}{\Delta t} \int_t^{t+\Delta t} C(t) dt$$

▼ M12

- 5.2.1.2.5. The test shall be carried out three times in each direction. Determine the average torque from these six measurements for the reference speed. If the average speed deviates by more than 1 km/h from the reference speed, a linear regression shall be used for calculating the average torque.

▼ M9

- 5.2.1.2.6. Determine the average of these two torques C_{ti} and C_{tr} i.e. C_t .

▼ M12

- 5.2.1.2.7. The average torque C_T determined on the track shall be corrected to the reference ambient conditions as follows:

$$C_{Tcorrected} = K \cdot C_{Tmeasured}$$

where K is defined in 5.1.1.2.8 of this Appendix.

▼ M9

5.2.2. *On the dynamometer*

5.2.2.1. Measurement equipment and error

The equipment must be identical to that used on the road.

5.2.2.2. Test procedure

5.2.2.2.1. Perform the operations specified in 5.1.2.2.1 to 5.1.2.2.4.

5.2.2.2.2. Perform the operations specified in 5.2.1.2.1 to 5.2.1.2.4.

▼ M12

5.2.2.2.3. Adjust the power absorption unit to reproduce the corrected total track torque of 5.2.1.2.7.

5.2.2.2.4. Proceed with the same operations as in 5.1.2.2.7, for the same purpose.

▼ **M9***Appendix 4***VERIFICATION OF INERTIAS OTHER THAN MECHANICAL**

1. OBJECT

The method described in this Appendix makes it possible to check that the simulated total inertia of the dynamometer is carried out satisfactorily in the running phases of the operating cycle. ► **M12** The manufacturer of the dynamometer shall provide a method to verify the specifications according to Section 3. ◀

2. PRINCIPLE

2.1. **Drawing up working equations**

Since the dynamometer is subjected to variations in the rotating speed of the roller(s), the force at the surface of the roller(s) can be expressed by the formula:

$$F = I \cdot \gamma = I_M \cdot \gamma + F_i$$

where:

F = force at the surface of the roller(s),

I = total inertia of the dynamometer (equivalent inertia of the vehicle: see table in Annex III section 5.1),

I_M = inertia of the mechanical masses of the dynamometer,

γ = tangential acceleration at roller surface,

F_i = inertia force.

Note:

An explanation of this formula with reference to dynamometers with mechanically simulated inertias is appended.

Thus, the total inertia is expressed as follows:

$$I = I_M + \frac{F_i}{\gamma}$$

where:

I_M can be calculated or measured by traditional methods.

F_i can be measured on the dynamometer, but can also be calculated from the peripheral speed of the rollers. γ may be calculated from the peripheral speed of the rollers.

The total inertia (I) is determined during an acceleration or deceleration test with values higher than or equal to those obtained on an operating cycle.

2.2. **Specification for the calculation of total inertia**

The test and calculation methods must make it possible to determine the total inertia I with a relative error ($\Delta I/I$) of less than 2 %.

3. SPECIFICATION

3.1. The mass of the simulated total inertia I must remain the same as the theoretical value of the equivalent inertia (see 5.1 of Annex III) within the following limits:

3.1.1. ± 5 % of the theoretical value for each instantaneous value;

3.1.2. ± 2 % of the theoretical value for the average value calculated for each sequence of the cycle.

3.2. The limit given in 3.1.1 is brought to ± 50 % for one second when starting and, for vehicles with manual transmission, for two seconds during gear changes.

▼ M9

4. VERIFICATION PROCEDURE
- 4.1. Verification is carried out during each test throughout the cycle defined in 2.1 of Annex III.
- 4.2. However, if the requirements of section 3 are met, with instantaneous accelerations which are at least three times greater or smaller than the values obtained in the sequences of the theoretical cycle, the verification described above is not necessary.

▼ M12

DESCRIPTION OF TAILPIPE EMISSION-SAMPLING SYSTEMS

1. INTRODUCTION
 - 1.1. There are several types of sampling devices capable of meeting the requirements set out in section 4.2 of Annex III.
The devices described in 3.1, 3.2 and 3.3 will be deemed acceptable if they satisfy the main criteria relating to the variable dilution principle.
 - 1.2. In its communications, the laboratory must mention the system of sampling used when performing the test.
2. CRITERIA RELATING TO THE VARIABLE-DILUTION SYSTEM FOR MEASURING EXHAUST-GAS EMISSIONS
 - 2.1. **Scope**
This section specifies the operating characteristics of an exhaust-gas sampling system intended to be used for measuring the true mass emissions of a vehicle exhaust in accordance with the provisions of this Directive. The principle of variable-dilution sampling for measuring mass emissions requires three conditions to be satisfied:
 - 2.1.1. the vehicle exhaust gases must be continuously diluted with ambient air under specified conditions;
 - 2.1.2. the total volume of the mixture of exhaust gases and dilution air must be measured accurately;
 - 2.1.3. a continuously proportional sample of the diluted exhaust gases and the dilution air must be collected for analysis.
The quantity of gaseous pollutants emitted is determined from the proportional sample concentrations and the total volume measured during the test. The sample concentrations are corrected to take account of the pollutant content of the ambient air. In addition, where vehicles are equipped with compression-ignition engines, their particulate emissions are plotted.
 - 2.2. **Technical summary**
Figure III.5.2.2 gives a schematic diagram of the sampling system.
 - 2.2.1. The vehicle exhaust gases must be diluted with a sufficient amount of ambient air to prevent any water condensation in the sampling and measuring system.
 - 2.2.2. The exhaust-gas sampling system must be so designed as to make it possible to measure the average volume concentrations of the CO₂, CO, HC and NO_x, and, in addition, in the case of vehicles equipped with compression-ignition engines, of the particulate emissions, contained in the exhaust gases emitted during the vehicle testing cycle.
 - 2.2.3. The mixture of air and exhaust gases must be homogeneous at the point where the sampling probe is located (see 2.3.1.2).
 - 2.2.4. The probe must extract a representative sample of the diluted gases.
 - 2.2.5. The system must make it possible to measure the total volume of the diluted exhaust gases from the vehicle being tested.

▼M9

Figure III.5.2.2

Diagram of variable-dilution system for measuring exhaust-gas emissions

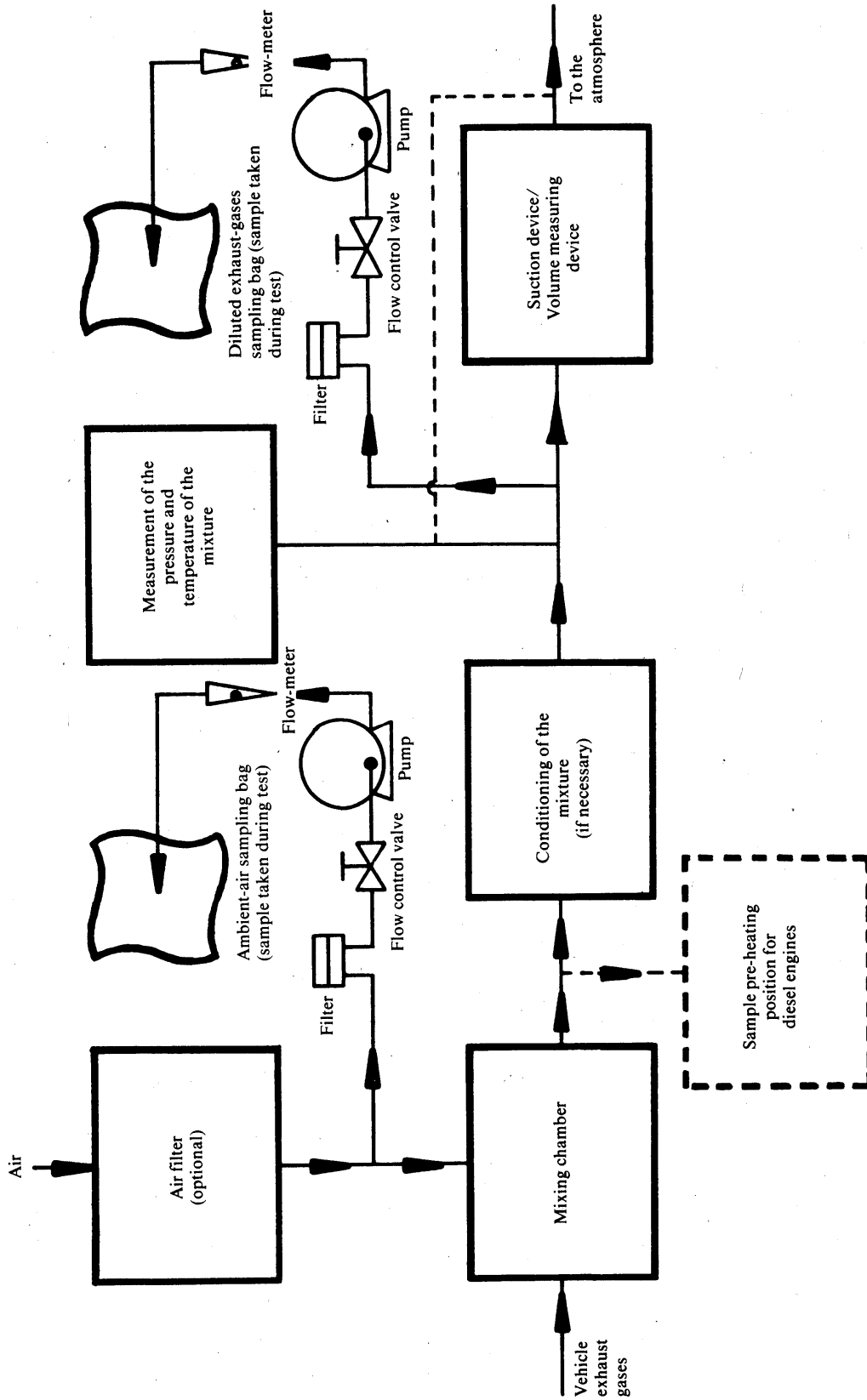

▼ **M9**

- 2.2.6. The sampling system must be gas-tight. The design of the variable-dilution sampling system and the materials that go to make it up must be such that they do not affect the pollutant concentration in the diluted exhaust gases. Should any component in the system (heat exchanger, cyclone separator, blower, etc.) change the concentration of any of the pollutants in the diluted exhaust gases and the fault cannot be corrected, then sampling for that pollutant must be carried out before that component.
- 2.2.7. If the vehicle tested is equipped with an exhaust system comprising more than one tailpipe, the connecting tubes must be connected together by a manifold installed as near as possible to the vehicle.
- 2.2.8. The gas samples must be collected in sampling bags of adequate capacity so as not to hinder the gas flow during the sampling period. These bags must be made of such materials as will not affect the concentration of pollutant gases (see 2.3.4.4).
- 2.2.9. The variable-dilution system must be so designed as to enable the exhaust gases to be sampled without appreciably changing the back-pressure at the exhaust pipe outlet (see 2.3.1.1).

2.3. **Specific requirements**2.3.1. *Exhaust-gas collection and dilution device*

- 2.3.1.1. The connection tube between the vehicle exhaust tailpipe(s) and the mixing chamber must be as short as possible; it must in no case:

- cause the static pressure at the exhaust tailpipe(s) on the vehicle being tested to differ by more than $\pm 0,75$ kPa at 50 km/h or more than $\pm 1,25$ kPa for the whole duration of the test from the static pressures recorded when nothing is connected to the vehicle tailpipes. The pressure must be measured in the exhaust tailpipe or in an extension having the same diameter, as near as possible to the end of the pipe,
- change the nature of the exhaust gas.

- 2.3.1.2. There must be a mixing chamber in which the vehicle exhaust gases and the dilution air are mixed so as to produce a homogeneous mixture at the chamber outlet.

The homogeneity of the mixture in any cross-section at the location of the sampling probe must not vary by more than ± 2 % from the average of the values obtained at least five points) located at equal intervals on the diameter of the gas stream. In order to minimize the effects on the conditions at the exhaust tailpipe and to limit the drop in pressure inside the dilution air-conditioning device, if any, the pressure inside the mixing chamber must not differ by more than 0,25 kPa from atmospheric pressure.

2.3.2. *Suction device/volume measuring device*

This device may have a range of fixed speeds so as to ensure sufficient flow to prevent any water condensation. This result is generally obtained by keeping the concentration of CO₂ in the dilute exhaust-gas sampling bag lower than 3 % by volume.

2.3.3. *Volume measurement*

- 2.3.3.1. The volume measuring device must retain its calibration accuracy to within ± 2 % under all operating conditions. If the device cannot compensate for variations in the temperature of the mixture of exhaust gases and dilution air at the measuring point, a heat exchanger must be used to maintain the temperature to within ± 6 K of the specified operating temperature.

If necessary, a cyclone separator can be used to protect the volume measuring device.

- 2.3.3.2. A temperature sensor must be installed immediately before the volume measuring device. This temperature sensor must have an accuracy and a precision of ± 1 K and a response time of 0,1 second at 62 % of a given temperature variation (value measured in silicone oil).

- 2.3.3.3. The pressure measurements must have a precision and an accuracy of $\pm 0,4$ kPa during the test.

▼ **M9**

- 2.3.3.4. The measurement of the pressure difference from atmospheric pressure is taken before and, if necessary, after the volume measuring device.
- 2.3.4. *Gas sampling*
- 2.3.4.1. Dilute exhaust gases
- 2.3.4.1.1. The sample of dilute exhaust gases is taken before the suction device but after the conditioning devices (if any).
- 2.3.4.1.2. The flow-rate must not deviate by more than ± 2 % from the average.
- 2.3.4.1.3. The sampling rate must not fall below 5 litres per minute and must not exceed 0,2 % of the flow-rate of the dilute exhaust gases.
- 2.3.4.1.4. An equivalent limit applies to constant-mass sampling systems.
- 2.3.4.2. Dilution air
- 2.3.4.2.1. A sample of the dilution air is taken at a constant flow-rate near the ambient air inlet (after the filter if one is fitted).
- 2.3.4.2.2. The air must not be contaminated by exhaust gases from the mixing area.
- 2.3.4.2.3. The sampling rate for the dilution air must be comparable to that used in the case of the dilute exhaust gases.
- 2.3.4.3. Sampling operations
- 2.3.4.3.1. The materials used for the sampling operations must be such that they do not change the pollutant concentration.
- 2.3.4.3.2. Filters may be used in order to extract the solid particles from the sample.
- 2.3.4.3.3. Pumps are required in order to convey the sample to the sampling bag(s).
- 2.3.4.3.4. Flow control valves and flow-meters are needed in order to obtain the flow-rates required for sampling.
- 2.3.4.3.5. Quick-fastening gas-tight connections may be used between the three-way valves and the sampling bags, the connections sealing themselves automatically on the bag side. Other systems may be used for conveying the samples to the analyzer (three-way stop valves, for example).
- 2.3.4.3.6. The various valves used for directing the sampling gases must be of the quick-adjusting and quick-acting type.
- 2.3.4.4. Storage of the sample
- The gas samples are collected in sampling bags of adequate capacity so as not to reduce the sampling rate. The bags must be made of such a material as will not change the concentration of synthetic pollutant gases by more than ± 2 % after 20 minutes.
- 2.4. **Additional sampling unit for the testing of vehicles equipped with a compression-ignition engine**
- 2.4.1. By way of a departure from the taking of gas samples from vehicles equipped with spark-ignition engines, the hydrocarbon and particulate sampling points are located in a dilution tunnel.
- 2.4.2. In order to reduce heat losses in the exhaust gases between the exhaust tail pipe and the dilution tunnel inlet, the pipe may not be more than 3,6 m long, or 6,1 m long if heat insulated. Its internal diameter may not exceed 105 mm.

▼ M9

Figure III.5.2.4.4.

Particulate sampling probe configuration

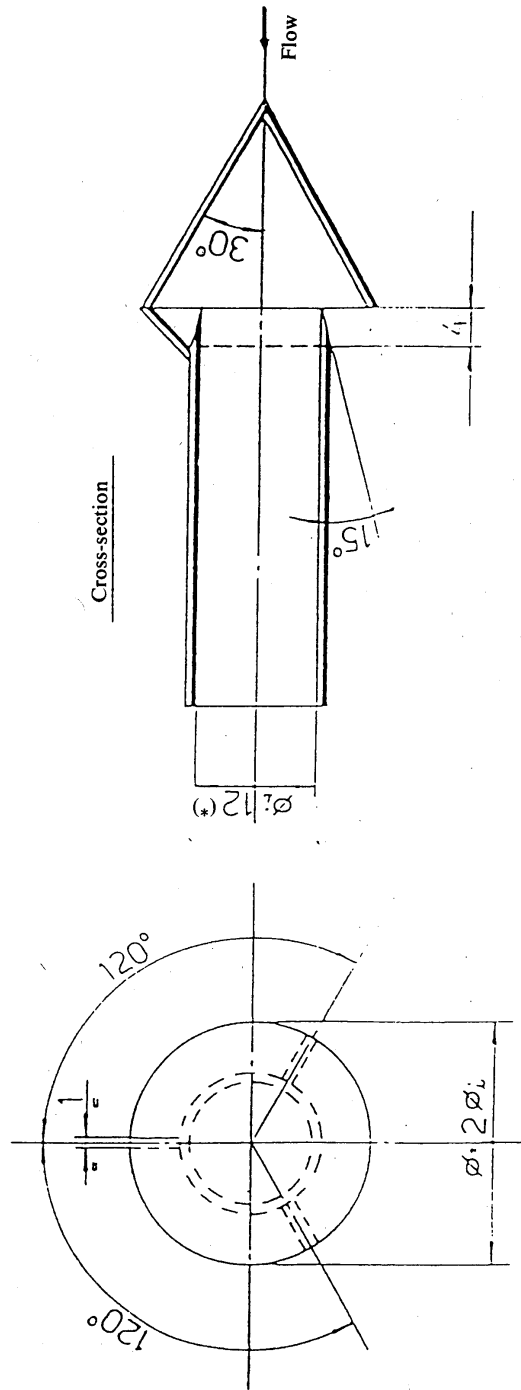

(*) Minimum internal diameter

Wall thickness: ~ 1 mm — Material: stainless steel

▼ **M9**

- 2.4.3. Predominantly turbulent flow conditions (Reynolds number $\geq 4\,000$) must apply in the dilution tunnel, which consists of a straight tube of electrically-conductive material, in order to guarantee that the diluted exhaust gas is homogeneous at the sampling points and that the samples consist of representative gases and particulates. The dilution tunnel must be at least 200 mm in diameter and the system must be earthed.
- 2.4.4. The particulate sampling system consists of a sampling probe in the dilution tunnel and two series-mounted filters. Quick-acting valves are located both up and downstream of the two filters in the direction of flow.
The configuration of the sample probe must be as indicated in Figure III.5.2.4.4.
- 2.4.5. The particulate sampling probe must be arranged as follows:
It must be installed in the vicinity of the tunnel centreline, roughly 10 tunnel diameters downstream of the gas inlet, and have an internal diameter of at least 12 mm.
The distance from the sampling tip to the filter mount must be at least five probe diameters, but must not exceed 1 020 mm.
- 2.4.6. The sample gas flow measuring unit consists of pumps, gas flow regulators and flow measuring units.
- 2.4.7. The hydrocarbon sampling system consists of a heated sampling probe, line, filter and pump. The sampling probe must be installed in such a way, at the same distance from the exhaust gas inlet as the particulate sampling probe, that neither interferes with samples taken by the other. It must have a minimum internal diameter of 4 mm.
- 2.4.8. All heated parts must be maintained at a temperature of 463 K (190 °C) ± 10 K by the heating system.
- 2.4.9. If it is not possible to compensate for variations in the flow rate there must be a heat exchanger and a temperature control device as specified in 2.3.3.1 so as to ensure that the flow rate in the system is constant and the sampling rate is accordingly proportional.

3. DESCRIPTION OF THE DEVICES

- 3.1. **Variable dilution device with positive displacement pump (PDP-CVS)** (Figure III.5.3.1.)
- 3.1.1. The positive displacement pump — constant volume sampler (PDP-CVS) satisfies the requirements of this Annex by metering at a constant temperature and pressure through the pump. The total volume is measured by counting the revolutions made by the calibrated positive displacement pump. The proportional sample is achieved by sampling with pump, flow-meter and flow control valve at a constant flow-rate.
- 3.1.2. Figure III.5.3.1 is a schematic drawing of such a sampling system. Since various configurations can produce accurate results exact conformity with the drawing is not essential. Additional components such as instruments, valves, solenoids and switches may be used to provide additional information and coordinate the functions of the component system.
- 3.1.3. The collecting equipment consists of:
- 3.1.3.1. a filter (D) for the dilution air, which can be preheated if necessary. This filter must consist of activated charcoal sandwiched between two layers of paper, and shall be used to reduce and stabilize the hydrocarbon concentrations of ambient emissions in the dilution air;
- 3.1.3.2. a mixing chamber (M) in which exhaust gas and air are mixed homogeneously;

▼ M9

Figure III.5.3.1

Constant volume sampler with positive displacement pump (PDP-CVS)

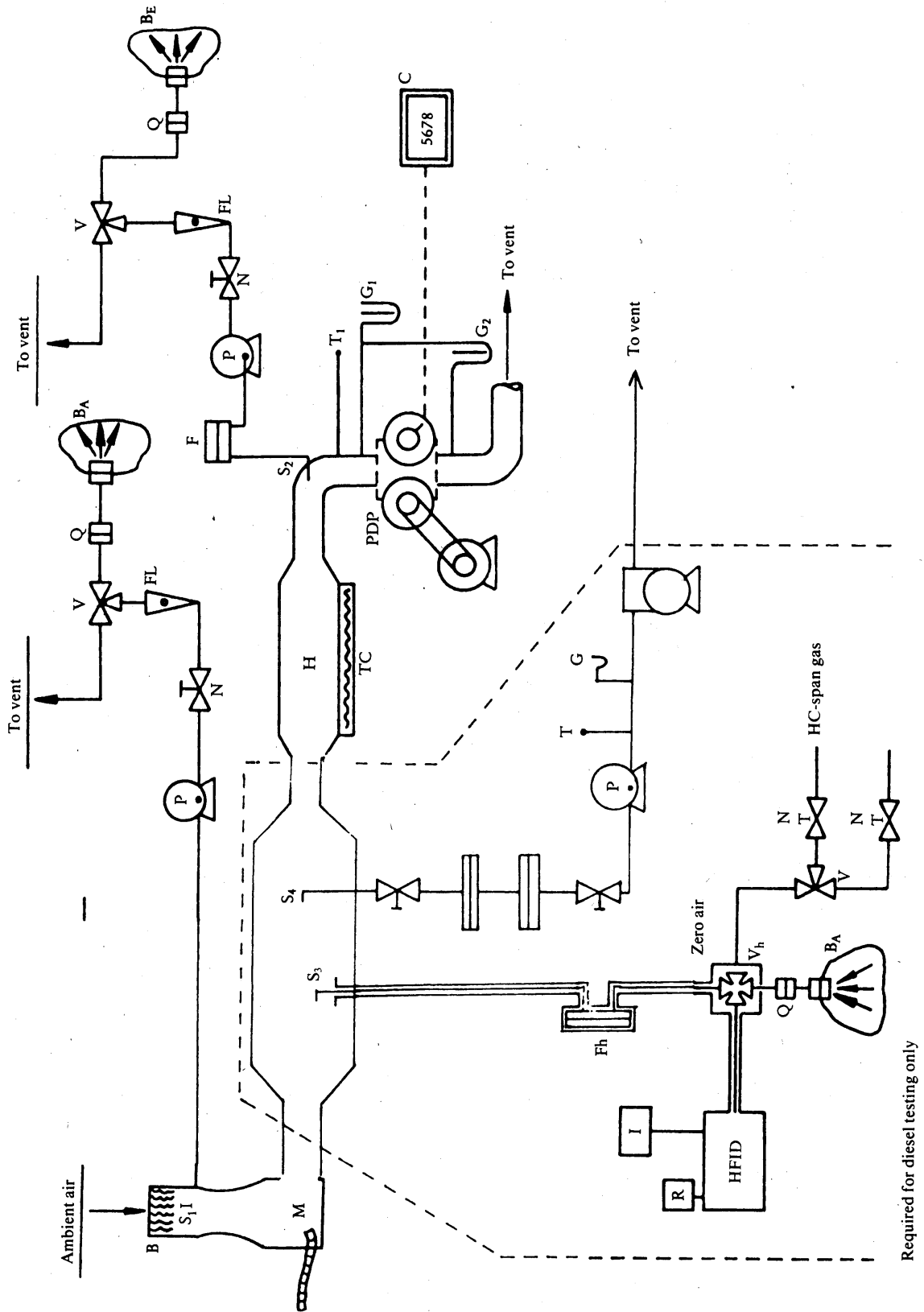

Required for diesel testing only

▼ **M9**

- 3.1.3.3. a heat exchanger (H) of a capacity sufficient to ensure that throughout the test the temperature of the air/exhaust-gas mixture measured at a point immediately upstream of the positive displacement pump is within ± 6 K of the designed operating temperature. This device must not affect the pollutant concentrations of diluted gases taken off after for analysis;
- 3.1.3.4. a temperature control system (TC), used to preheat the heat exchanger before the test and to control its temperature during the test, so that deviations from the designed operating temperature are limited to ± 6 K;
- 3.1.3.5. the positive displacement pump (PDP), used to transport a constant-volume flow of the air/exhaust-gas mixture; the flow capacity of the pump must be large enough to eliminate water condensation in the system under all operating conditions which may occur during a test; this can be generally ensured by using a positive displacement pump with a flow capacity:
- 3.1.3.5.1. — twice as high as the maximum flow of exhaust gas produced by accelerations of the driving cycle, or
- 3.1.3.5.2. — sufficient to ensure that the CO₂ concentration in the dilute-exhaust sample bag is ► **M14** less than 3 % by volume for petrol and diesel, less than 2,2 % by volume for LPG and less than 1,5 % by volume for NG; ◀
- 3.1.3.6. a temperature sensor (T₁) (accuracy and precision ± 1 K), fitted at a point immediately upstream of the positive displacement pump; it must be designed to monitor continuously the temperature of diluted exhaust-gas mixture during the test;
- 3.1.3.7. a pressure gauge (G₁) (accuracy and precision $\pm 0,4$ kPa) fitted immediately upstream of the volume meter and used to register the pressure gradient between the gas mixture and the ambient air;
- 3.1.3.8. another pressure gauge (G₂) (accuracy and precision $\pm 0,4$ kPa) fitted so that the different pressure between pump inlet and pump outlet can be registered;
- 3.1.3.9. two sampling outlets (S₁ and S₂) for taking constant samples of the dilution air and of the diluted exhaust-gas/air mixture;
- 3.1.3.10. a filter (F), to extract solid particles from the flows of gas collected for analysis;
- 3.1.3.11. pumps (P), to collect a constant flow of the dilution air as well as the diluted exhaust-gas/air mixture during the test;
- 3.1.3.12. flow controllers (N), to ensure a constant uniform flow of the gas samples taken during the course of the test from sampling probes S₁ and S₂; and flow of the gas samples must be such that, at the end of each test, the quantity of the samples is sufficient for analysis (~ 10 litres per minute);
- 3.1.3.13. flow-meters (FL), for adjusting and monitoring the constant flow of gas samples during the test;
- 3.1.3.14. quick-acting valves (V), to divert a constant flow of gas samples into the sampling bags or to the outside vent;
- 3.1.3.15. gas-tight, quick-lock coupling elements (Q) between the quick-acting valves and the sampling bags; the coupling must close automatically on the sampling-bag side; as an alternative, other ways of transporting the samples to the analyzer may be used (three-way stopcocks, for instance);
- 3.1.3.16. bags (B), for collecting samples of the diluted exhaust gas and of the dilution air during the test; they must be of sufficient capacity not to impede the sample flow; the bag material must be such as to affect neither the measurements themselves nor the chemical composition of the gas samples (for instance: laminated polyethylene/polyamide films, or fluorinated polyhydrocarbons);
- 3.1.3.17. a digital counter (C), to register the number of revolutions performed by the positive displacement pump during the test;

▼ **M9**3.1.4. *Additional equipment required when testing diesel-engined vehicles*

To comply with the requirements of 4.3.1.1 and 4.3.2 of Annex III, the additional components within the dotted lines in Figure III.5.3.1 must be used when testing diesel-engined vehicles:

- F_h is a heated filter,
- S₃ is a sample point close to the mixing chamber,
- V_h is a heated multiway valve,
- Q is a quick connector to allow the ambient air sample BA to be analysed on the HFID,
- HFID is a heated flame ionization analyzer,
- R and I are means of integrating and recording the instantaneous hydrocarbon concentrations,
- L_h is a heated sample line.

All heated components must be maintained at 463 K (190 °C) ± 10 K.

Particulate sampling system

- S₄ sampling probe in the dilution tunnel,
- F_p filter unit consisting of two series-mounted filters; switching arrangement for further parallel-mounted pairs of filters,
- sampling line,
- pumps, flow regulators, flow measuring units.

3.2. **Critical-flow venturi dilution device (CFV-CVS)** (Figure III.5.3.2.)

3.2.1. Using a critical-flow venturi in connection with the CVS sampling procedure is based on the principles of flow mechanics for critical flow. The variable mixture flow rate of dilution and exhaust gas is maintained as sonic velocity which is directly proportional to the square root of the gas temperature. Flow is continually monitored, computed and integrated over the test.

If an additional critical-flow sampling venturi is used, the proportionality of the gas samples taken is ensured. As both pressure and temperature are equal at the two venturi inlets the volume of the gas flow diverted for sampling is proportional to the total volume of diluted exhaust-gas mixture produced, and thus the requirements of this Annex are met.

3.2.2. Figure III.5.3.2 is a schematic drawing of such a sampling system. Since various configurations can produce accurate results, exact conformity with the drawing is not essential. Additional components such as instruments, valve, solenoids, and switches may be used to provide additional information and coordinate the functions of the component system.

3.2.3. The collecting equipment consists of:

- 3.2.3.1. a filter (D) for the dilution air, which can be preheated if necessary: the filter must consist of activated charcoal sandwiched between layers of paper, and must be used to reduce and stabilize the hydrocarbon background emission of the dilution air;
- 3.2.3.2. a mixing chamber (M), in which exhaust gas and air are mixed homogeneously;
- 3.2.3.3. a cyclone separator (CS), to extract particles;
- 3.2.3.4. two sampling probes (S₁ and S₂) for taking samples of the dilution air and of the diluted exhaust gas/air mixture;
- 3.2.3.5. a sampling critical flow venturi (SV), to take proportional samples of the diluted exhaust gas at sampling probe S₂;
- 3.2.3.6. a filter (F), to extract solid particles from the gas flows diverted for analysis;
- 3.2.3.7. pumps (P), to collect part of the flow of air and diluted exhaust gas in bags during the test;
- 3.2.3.8. a flow controller (N), to ensure a constant flow of the gas samples taken in the course of the test from sampling probe S₁;

▼ M9

the flow of the gas samples must be such that, at the end of the test, the quantity of the samples is sufficient for analysis (10 litres per minute);

- 3.2.3.9. a snubber (PS), in the sampling line;

▼ M9

Figure III.5.3.2

Constant volume sampler with critical-flow venturi (CFV-CVS System)

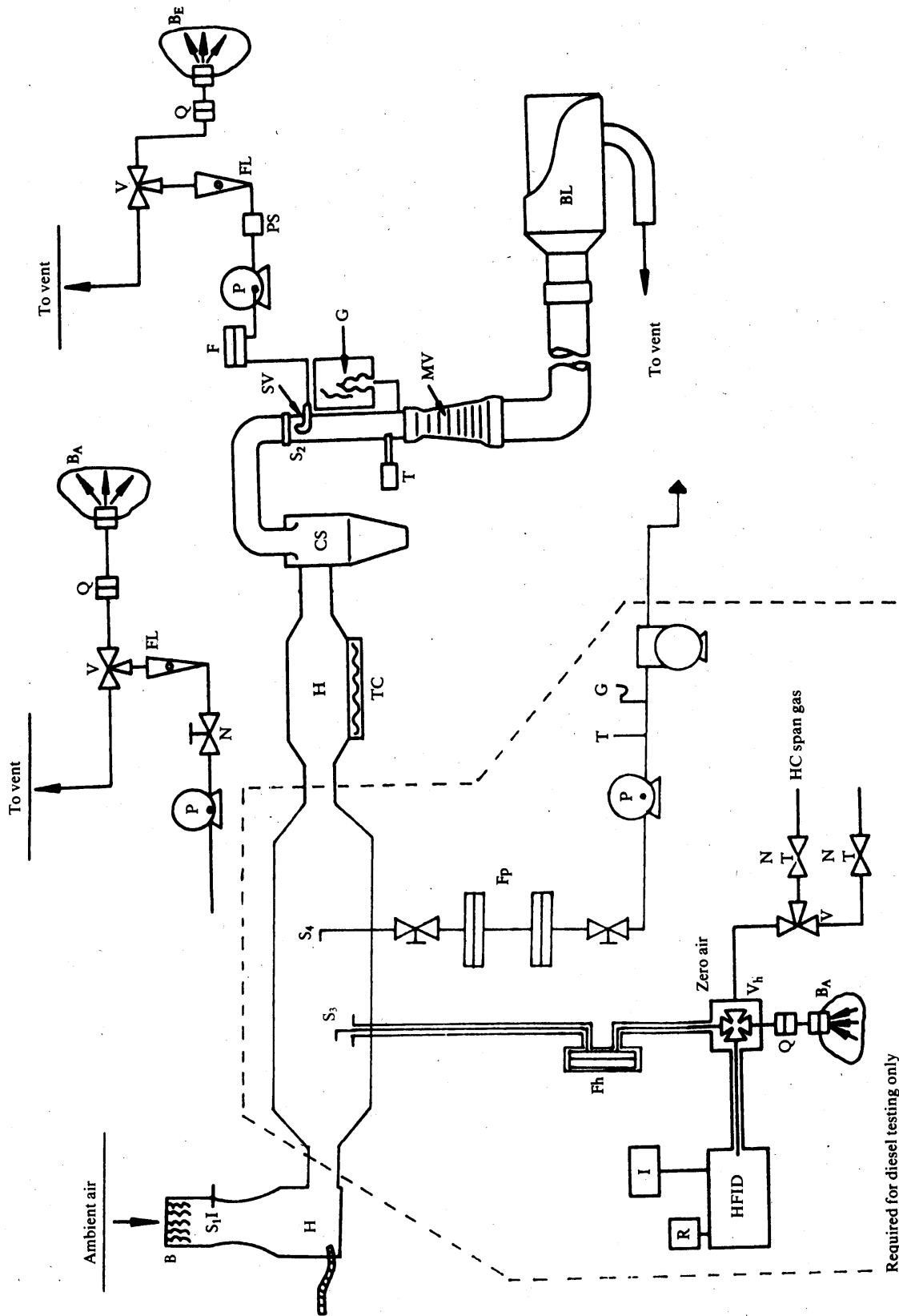

▼ **M9**

- 3.2.3.10. flow meters (FL), for adjusting and monitoring the flow of gas samples during tests;
- 3.2.3.11. quick-acting solenoid valves (V), to divert a constant flow of gas samples into the sampling bags or the vent;
- 3.2.3.12. gas-tight, quick-lock coupling elements (Q), between the quick-acting valves and the sampling bags; the couplings must close automatically on the sampling bag side; as an alternative, other ways of transporting the samples to the analyzer may be used (three-way stopcocks, for instance);
- 3.2.3.13. bags (B), for collecting samples of the diluted exhaust gas and the dilution air during the tests; they must be of sufficient capacity not to impede the sample flow; the bag material must be such as to affect neither the measurements themselves nor the chemical composition of the gas samples (for instance: laminated polyethylene/polyamide films, or fluorinated polyhydrocarbons);
- 3.2.3.14. a pressure gauge (G), which is precise and accurate to within $\pm 0,4$ kPa;
- 3.2.3.15. a temperature sensor (T), which is precise and accurate to within ± 1 K and have a response time of 0,1 seconds to 62 % of a temperature change (as measured in silicon oil);
- 3.2.3.16. a measuring critical flow venturi tube (MV), to measure the flow volume of the diluted exhaust gas;
- 3.2.3.17. a blower (BL), of sufficient capacity to handle the total volume of diluted exhaust gas;
- 3.2.3.18. the capacity of the CFV-CVS system must be such that under all operating conditions which may possibly occur during a test there will be no condensation of water. This is generally ensured by using a blower whose capacity is:
 - 3.2.3.18.1. twice as high as the maximum flow of exhaust gas produced by accelerations of the driving cycle, or
 - 3.2.3.18.2. sufficient to ensure that the CO₂ concentration in the dilute exhaust sample bag is less than 3 % by volume.
- 3.2.4. *Additional equipment required when testing diesel-engined vehicles*

To comply with the requirements of 4.3.1.1 and 4.3.2 of Annex III, the additional components shown within the dotted lines of Figure III.5.3.2 must be used when testing diesel-engined vehicles:

Fh is a heated filter,

S₃ is a sample point close to the mixing chamber,

V_h is a heated multiway valve,

Q is a quick connector to allow the ambient air sample BA to be analyzed on the HFID,

HFID is a heated flame ionization analyzer,

R and I are a means of integrating and recording the instantaneous hydrocarbon concentrations,

Lh is a heated sample line.

All heated components must be maintained at 463 K (190 °C) ± 10 K.

If compensation for varying flow is not possible, then a heat exchanger (H) and temperature control system (TC) as described in 2.2.3 will be required to ensure constant flow through the venturi (MV) and thus proportional flow through S₃.

▼ M9

Particulate sampling system

- S₄ sampling probe in dilution tunnel,
- F_p filter unit consisting of two series-mounted filters;
switching unit for further parallel-mounted pairs of
filters,
sampling line,
pumps, flow regulators, flow measuring units.

▼ M12 _____

METHOD OF CALIBRATING THE EQUIPMENT

1. ESTABLISHMENT OF THE CALIBRATION CURVE
 - 1.1. Each normally used operating range is calibrated in accordance with the requirements of 4.3.3 of Annex III by the following procedure:
 - 1.2. The analyzer calibration curve is established by at least five calibration points spaced as uniformly as possible. The nominal concentration of the calibration gas of the highest concentration must be not less than 80 % of the full scale.
 - 1.3. The calibration curve is calculated by the least squares method. If the resulting polynomial degree is greater than three, the number of calibration points must be at least equal to this polynomial degree plus two.
 - 1.4. The calibration curve must not differ by more than 2 % from the nominal value of each calibration gas.
 - 1.5. **Trace of the calibration curve**
 From the trace of the calibration curve and the calibration points it is possible to verify that the calibration has been carried out correctly. The different characteristic parameters of the analyzer must be indicated, particularly:
 - the scale,
 - the sensitivity,
 - the zero point,
 - the date of carrying out the calibration.
 - 1.6. If it can be shown to the satisfaction of the technical service that alternative technology (e.g. computer, electronically controlled range switch, etc.) can give equivalent accuracy, then these alternatives may be used.
 - 1.7. **Verification of the calibration**
 - 1.7.1. Each normally used operating range must be checked prior to each analysis in accordance with the following:
 - 1.7.2. The calibration is checked by using a zero gas and a span gas whose nominal value is within 80 to 95 % of the supposed value to be analyzed.
 - 1.7.3. If, for the two points considered, the value found does not differ by more than ± 5 % of the full scale from the theoretical value, the adjustment parameters may be modified. Should this not be the case, a new calibration curve must be established in accordance with section 1.
 - 1.7.4. After testing, zero gas and the same span gas are used for re-checking. The analysis is considered acceptable if the difference between the two measuring results is less than 2 %.
2. CHECK FOR FID, HYDROCARBON RESPONSE
 - 2.1. **Detector response optimization**
 The FID must be adjusted, as specified by the instrument manufacturer. Propane in air should be used, to optimize the response, on the most common operating range.
 - 2.2. **Calibration of the HC analyzer**
 The analyzer should be calibrated using propane in air and purified synthetic air. See section 4.5.2 of Annex III (calibration and span gases).

 Establish a calibration curve as described in sections 1.1 to 1.5 of this Appendix.

▼ M9**2.3. Response factors of different hydrocarbons and recommended limits**

The response factor (Rf) for a particular hydrocarbon species is the ratio of the FID C_1 reading to the gas cylinder concentration, expressed as ppm C_1 .

The concentration of the test gas must be at a level to give a response of approximately 80 % of full scale deflection, for the operating range. The concentration must be known, to an accuracy of ± 2 % in reference to a gravimetric standard expressed in volume. In addition the gas cylinder must be pre-conditioned for 24 hours at a temperature between 293 and 303 K (20 and 30 °C).

Response factors are determined when introducing an analyzer into service and thereafter at major service intervals. The test gases to be used and the recommended response factor are:

▼ M14

- methane and purified air 1,00 < Rf < 1,15,
- or
- 1,00 < Rf < 1,05
for NG-fuelled
vehicles,

▼ M9

- propylene and purified air 0,90 < Rf < 1,00,
- toluene and purified air 0,90 < Rf < 1,00.

Relative to a response factor (Rf) of 1,00 for propane and purified air.

2.4. Oxygen interference check and recommended limits

The response factor should be determined as described in 2.3. The test gas to be used and recommended response factor range are:

- Propane and nitrogen 0,95 ≤ Rf ≤ 1,05

3. EFFICIENCY TEST OF THE NO_x CONVERTER

The efficiency of the converter used for the conversion of NO₂ into NO is tested as follows:

Using the test set up as shown in Figure III.6.3 and the procedure described below, the efficiency of converters can be tested by means of an ozonator.

- 3.1. Calibrate the CLA in the most common operating range following the manufacturer's specifications using zero and span gas (the NO content of which must amount to about 80 % of the operating range and the NO₂ concentration of the gas mixture to less than 5 % of the NO concentration). The NO_x analyzer must be in the NO mode so that the span gas does not pass through the converter. Record the indicated concentration.
- 3.2. Via a T-fitting, oxygen or synthetic air is added continuously to the gas flow until the concentration indicated is about 10 % less than the indicated calibration concentration given in 3.1. Record the indicated concentration (C). The ozonator is kept deactivated throughout this process.
- 3.3. The ozonator is now activated to generate enough ozone to bring the NO concentration down to 20 % (minimum 10 %) of the calibration concentration given in 3.1. Record the indicated concentration (d).
- 3.4. The NO_x analyzer is then switched to the NO_x mode which means that the gas mixture (consisting of NO, NO₂, O₂ and N₂) now passes through the converter. Record the indicated concentration (a).
- 3.5. The ozonator is now deactivated. The mixture of gases described in 3.2 passes through the converter into the detector. Record the indicated concentration (b).

▼ M9

- 3.6. With the ozonator deactivated, the flow of oxygen or synthetic air is also shut off. The NO_x reading of the analyzer must then be no more than 5 % above the figure given in 3.1.
- 3.7. The efficiency of the NO_x converter is calculated as follows:

$$\text{Efficiency (\%)} = \left(1 + \frac{a-b}{c-d}\right) \cdot 100$$

Figure III.6.3

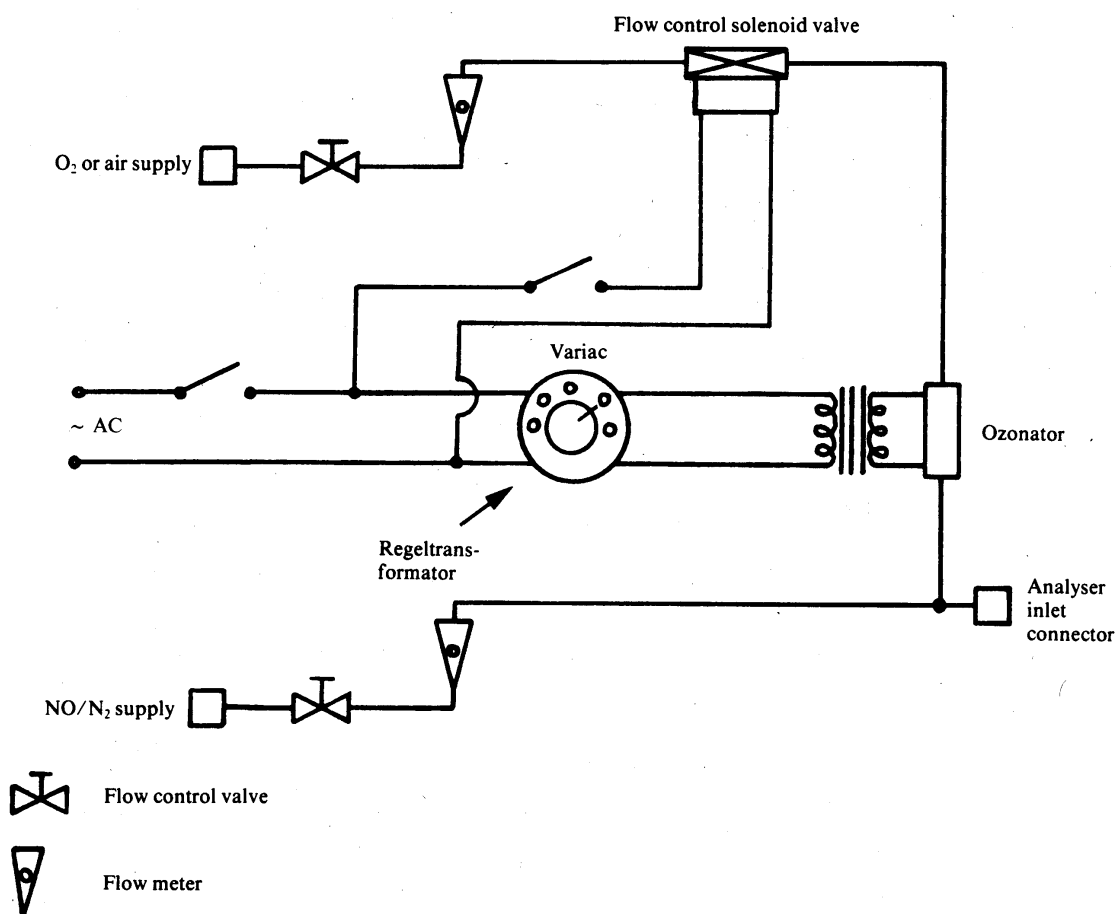
Diagram of NO_x converter efficiency device

- 3.8. The efficiency of the converter must not be less than 95 %.
- 3.9. The efficiency of the converter must be tested at least once a week.

4. CALIBRATION OF THE CVS SYSTEM

- 4.1. The CVS system must be calibrated by using an accurate flow-meter and a restricting device. The flow through the system must be measured at various pressure readings and the control parameters of the system measured and related to the flows.
- 4.1.1. Various types of flow-meter may be used, e.g. calibrated venturi, laminar flow-meter, calibrated turbine-meter, provided that they are dynamic measurement systems and can meet the requirements of sections 4.2.2 and 4.2.3 of Annex III.
- 4.1.2. The following sections give details of methods of calibrating PDP and CFV units, using a laminar flow-meter, which gives the required accuracy, together with a statistical check on the calibration validity.

▼ **M9****4.2. Calibration of the positive displacement pump (PDP)**

4.2.1. The following calibration procedure outlines the equipment, the test configuration and the various parameters which are measured to establish the flow-rate of the CVS pump. All the parameters related to the pump are simultaneously measured with the parameters related to the flow-meter which is connected in series with the pump. The calculated flow-rate (given in m³/min at pump inlet, absolute pressure and temperature) can then be plotted versus a correlation function which is the value of a specific combination of pump parameters. The linear equation which relates the pump flow and the correlation function is then determined. In the event that a CVS has a multiple speed drive, a calibration for each range used must be performed.

4.2.2. This calibration procedure is based on the measurement of the absolute values of the pump and flow-meter parameters that relate the flow-rate at each point. Three conditions must be maintained to ensure the accuracy and integrity of the calibration curve.

4.2.2.1. The pump pressures must be measured at tapings on the pump rather than at the external piping on the pump inlet and outlet. Pressure taps that are mounted at the top centre and bottom centre of the pump drive headplate are exposed to the actual pump cavity pressures, and therefore reflect the absolute pressure differentials.

4.2.2.2. Temperature stability must be maintained during the calibration. The laminar flow-meter is sensitive to inlet temperature oscillations which cause the data points to be scattered. Gradual changes of ± 1 K in temperature are acceptable as long as they occur over a period of several minutes.

4.2.2.3. All connections between the flow-meter and the CVS pump must be free of any leakage.

4.2.3. During an exhaust emission test, the measurement of these same pump parameters enables the user to calculate the flow-rate from the calibration equation.

4.2.3.1. Figure III.6.4.2.3.1 of this Appendix shows one possible test set-up. Variations are permissible, provided that they are approved by the authority granting the approval as being of comparable accuracy. If the set-up shown in Figure III.5.3.2 of Appendix 5 is used, the following data must be found within the limits of precision given:

| | |
|---|------------------|
| barometric pressure (corrected) (PB) | $\pm 0,03$ kPa |
| ambient temperature (T) | $\pm 0,2$ K |
| air temperature at LFE (ETI) | $\pm 0,15$ K |
| pressure depression upstream of LFE (EPI) | $\pm 0,01$ kPa |
| pressure drop across the LFE matrix (EDP) | $\pm 0,0015$ kPa |
| air temperature at CVS pump inlet (PTI) | $\pm 0,2$ K |
| air temperature at CVS pump outlet (PTO) | $\pm 0,2$ K |
| pressure depression at CVS pump inlet (PPI) | $\pm 0,22$ kPa |
| pressure head at CVS pump outlet (PPO) | $\pm 0,22$ kPa |
| pump revolutions during test period (n) | ± 1 rev |
| elapsed time for period (minimum 250 s) (t) | $\pm 0,1$ s. |

4.2.3.2. After the system has been connected as shown in Figure III.6.4.2.3.1, set the variable restrictor in the wide-open position and run the CVS pump for 20 minutes before starting the calibration.

▼ M9

- 4.2.3.3. Reset the restrictor valve to a more restricted condition in an increment of pump inlet depression (about 1 kPa) that will yield a minimum of six data points for the total calibration. Allow the system to stabilize for three minutes and repeat the data acquisition.

Figure III.6.4.2.3.1

PDP-CVS calibration configuration

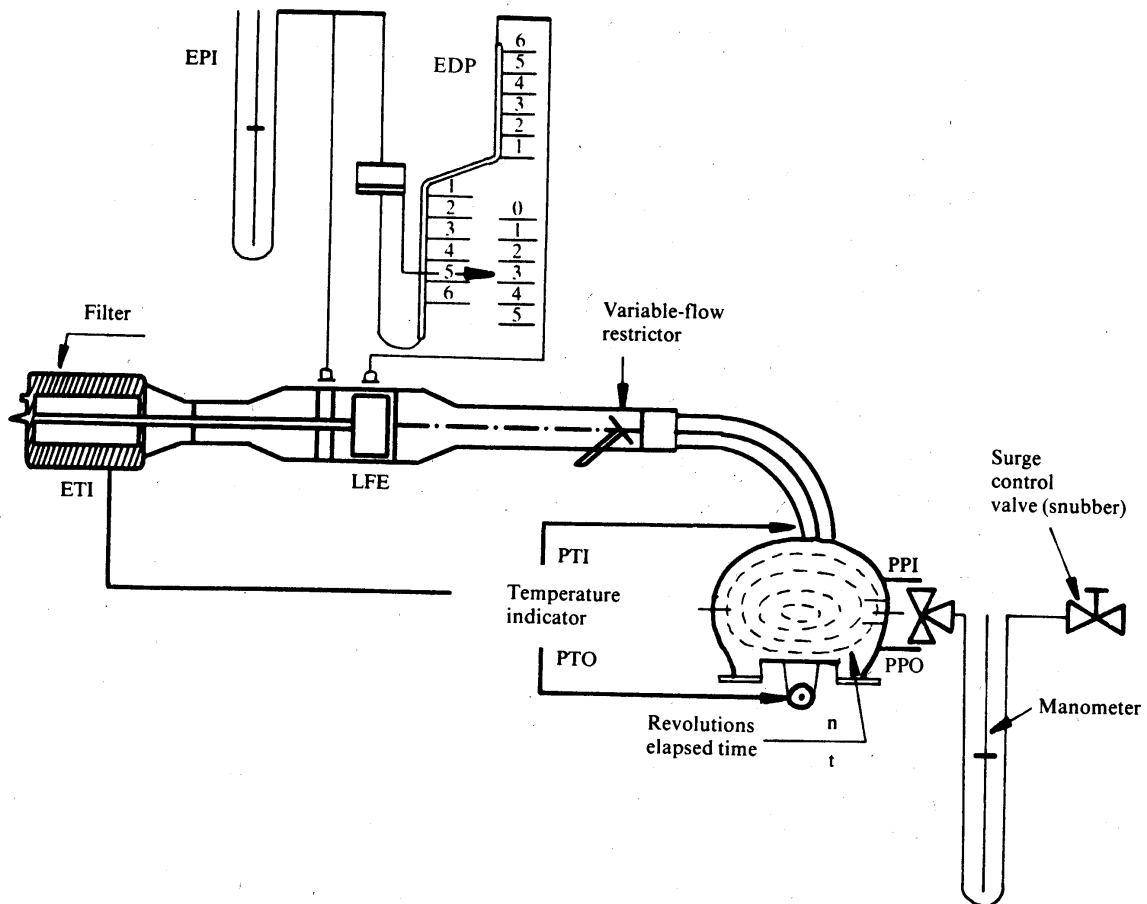

- 4.2.4. *Data analysis*
- 4.2.4.1. The air flow-rate (Q_s) at each test point is calculated in standard m^3/min from the flow-meter data using the manufacturer's prescribed method.
- 4.2.4.2. The air flow-rate is then converted to pump flow (V_o) in m^3/rev at absolute pump inlet temperature and pressure.

$$V_o = \frac{Q_s}{n} \cdot \frac{T_p}{273,2} \cdot \frac{101,33}{P_p}$$

where:

- V_o = pump flow-rate at T_p and P_p given in m^3/rev ,
 Q_s = air flow at 101,33 kPa and 273,2 K given in m^3/min ,
 T = pump inlet temperature (K),
 P_p = absolute pump inlet pressure,
 n = pump speed in revolutions per minute.

To compensate for the interaction of pump speed pressure variations at the pump and the pump slip rate, the correlation function (X_o) between the pump speed (n), the pressure differential from pump inlet to pump outlet and the absolute pump outlet pressure is then calculated as follows:

▼ **M9**

$$X_o = \frac{1}{n} \sqrt{\frac{\Delta P_p}{P_e}}$$

where:

X_o = correlation function,

ΔP_p = pressure differential from pump inlet to pump outlet (kPa),

P_e = absolute outlet pressure ($PPO + P_B$) (kPa).

A linear least-square fit is performed to generate the calibration equations which have the formulae:

$$V_o = D_o - M (X_o)$$

$$n = A - B (\Delta P_p)$$

D_o , M , A and B are the slope-intercept constants describing the lines.

- 4.2.4.3. A CVS system that has multiple speeds must be calibrated on each speed used. The calibration curves generated for the ranges must be approximately parallel and the intercept values (D_o) must increase as the pump flow range decreases.

If the calibration has been performed carefully, the calculated values from the equation will be within $\pm 0,5$ % of the measured value of V_o . Values of M will vary from one pump to another. Calibration is performed at pump start-up and after major maintenance.

4.3. **Calibration of the critical-flow venturi (CFV)**

- 4.3.1. Calibration of the CFV is based upon the flow equation for a critical venturi:

$$Q_s = \frac{K_v \cdot P}{\sqrt{T}}$$

where:

Q_s = flow,

K_v = calibration coefficient,

P = absolute pressure (kPa),

T = absolute temperature (K).

Gas flow is a function of inlet pressure and temperature.

The calibration procedure described below establishes the value of the calibration coefficient at measured values of pressure, temperature and air flow.

- 4.3.2. The manufacturer's recommended procedure must be followed for calibrating electronic portions of the CFV.
- 4.3.3. Measurements for flow calibration of the critical flow venturi are required and the following data must be found within the limits of precision given:

| | |
|---|-------------------|
| barometric pressure (corrected) (P_B) | $\pm 0,03$ kPa, |
| LFE air temperature, flow-meter (ETI) | $\pm 0,15$ K, |
| pressure depression upstream of LFE (EPI) | $\pm 0,01$ kPa, |
| pressure drop across (EDP) LFE matrix | $\pm 0,0015$ kPa, |
| air flow (Q_s) | $\pm 0,5$ %, |
| CFV inlet depression (PPI) | $\pm 0,02$ kPa, |
| temperature at venturi inlet (T_v) | $\pm 0,2$ K. |

▼ M9

- 4.3.4. The equipment must be set up as shown in Figure III.6.4.3.4 and checked for leaks. Any leaks between the flow-measuring device and the critical-flow venturi seriously affect the accuracy of the calibration.

Figure III.6.4.3.4

CFV-CVS calibration configuration

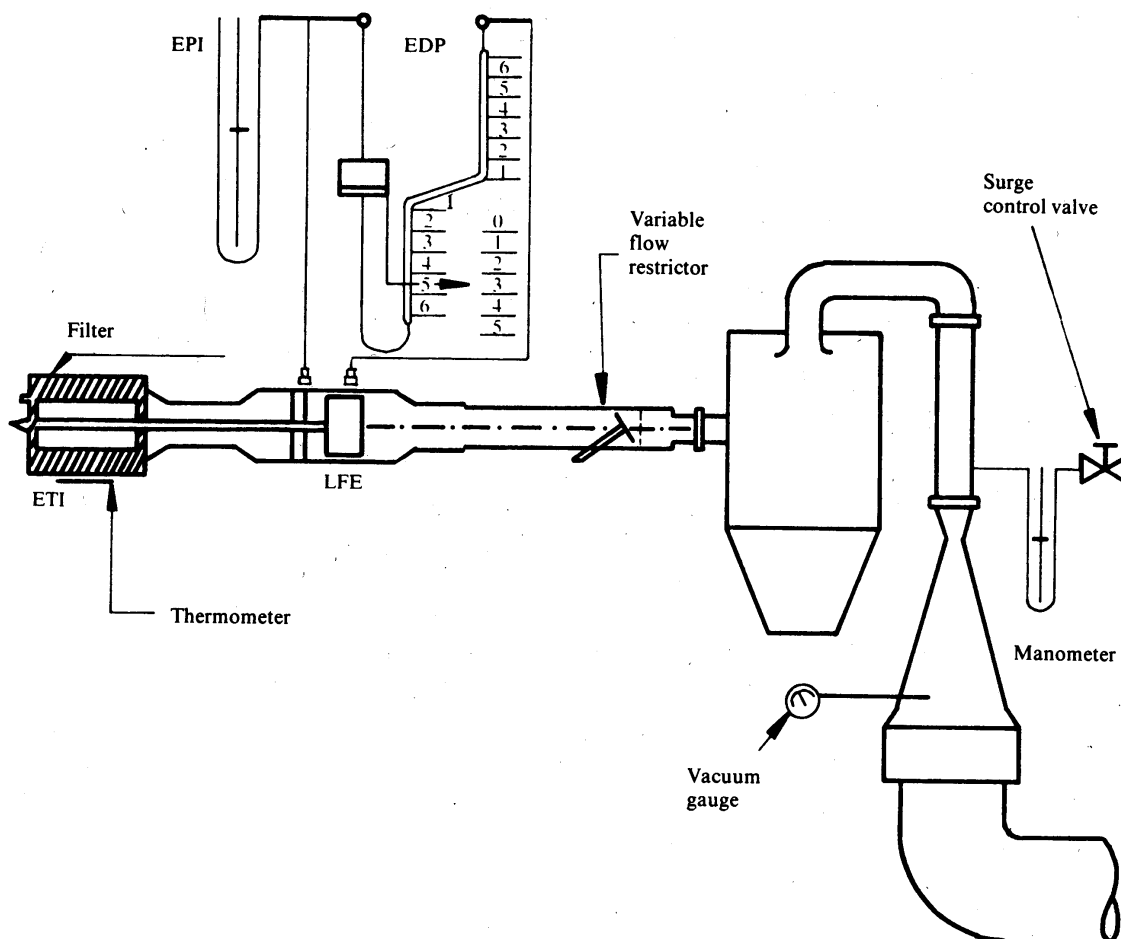

- 4.3.5. The variable-flow restrictor must be set to the open position, the blower started and the system stabilized. Data from all instruments must be recorded.
- 4.3.6. The flow restrictor must be varied and at least eight readings across the critical flow range of the venturi must be made.
- 4.3.7. The data recorded during the calibration must be used in the following calculations. The air flow-rate (Q_s) at each test point is calculated from the flow-meter data using the manufacturer's prescribed method.

Calculate values of the calibration coefficient for each test point:

$$K_v = \frac{Q_s \cdot \sqrt{T_v}}{P_v}$$

where:

Q_s = flow-rate in m³/min at 273,2 K and 101,33 kPa,

T_v = temperature at the venturi inlet (K),

P_v = absolute pressure at the venturi inlet (kPa).

Plot K_v as a function of venturi inlet pressure. For sonic flow K_v will have a relatively constant value. As pressure decreases

▼ M9

(vacuum increases) the venturi become unchoked and K_v decreases. The resultant K_v changes are not permissible.

For a minimum of eight points and the critical region calculate an average K_v and the standard deviation.

If the standard deviation exceeds 0,3 % of the average K_v take corrective action.

*Appendix 7***TOTAL SYSTEM VERIFICATION**

1. To comply with the requirements of section 4.7 of Annex III, the total accuracy of the CVS sampling system and analytical system must be determined by introducing a known mass of a pollutant gas into the system whilst it is being operated as if during a normal test and then analyzing and calculating the pollutant mass according to the formulae in Appendix 8 to this Annex except that the density of propane is taken as 1,967 grams per litre at standard conditions. The following two techniques are known to give sufficient accuracy.
2. Metering a constant flow of pure gas (CO or C₃H₈) using a critical-flow orifice device
- 2.1. A known quantity of pure gas (CO or C₃H₈) is fed into the CVS system through the calibrated critical orifice. If the inlet pressure is high enough, the flow-rate (q), which is adjusted by means of the critical-flow orifice, is independent of orifice outlet pressure (critical flow). If deviations exceeding 5 % occur, the cause of the malfunction must be located and determined. The CVS system is operated as in an exhaust emission test for about 5 to 10 minutes. The gas collected in the sampling bag is analyzed by the usual equipment and the results compared to the concentration of the gas samples which was known beforehand.
3. Metering a limited quantity of pure gas (CO or C₃H₈) by means of a gravimetric technique
- 3.1. The following gravimetric procedure may be used to verify the CVS system. The weight of a small cylinder filled with either carbon monoxide or propane is determined with a precision of ± 0,01 gram. For about 5 to 10 minutes, the CVS system is operated as in a normal exhaust emission test, while CO or propane is injected into the system. The quantity of pure gas involved is determined by means of differential weighting. The gas accumulated in the bag is then analyzed by means of the equipment normally used for exhaust-gas analysis. The results are then compared to the concentration figures computed previously.

▼ **M9***Appendix 8***CALCULATION OF THE EMISSION OF POLLUTANTS**

1. GENERAL

- 1.1. Emissions of gaseous pollutants are calculated by means of the following equation:

$$M_i = \frac{V_{\text{mix}} \cdot Q_i \cdot k_H \cdot C_i \cdot 10^{-6}}{d} \quad (1)$$

where:

- M_i = mass emission of the pollutant i in grams per kilometre,
 V_{mix} = volume of the diluted exhaust gas expressed in litres per test and corrected to standard conditions (273,2 K and 101,33 kPa),
 Q_i = density of the pollutant i in grams per litre at normal temperature and pressure (273,2 K and 101,33 kPa),
 k_H = humidity correction factor used for the calculation of the mass emissions of oxides of nitrogen (there is no humidity correction for HC and CO),
 C_i = concentration of the pollutant i in the diluted exhaust gas expressed in ppm and corrected by the amount of the pollutant i contained in the dilution air,
 d = actual distance corresponding to the operating cycle in km.

1.2. **Volume determination**

- 1.2.1. Calculation of the volume when a variable dilution device with constant flow control by orifice or venturi is used. Record continuously the parameters showing the volumetric flow, and calculate the total volume for the duration of the test.
- 1.2.2. Calculation of volume when a positive displacement pump is used. The volume of diluted exhaust gas in systems comprising a positive displacement pump is calculated with the following formula:

$$V = V_o \cdot N$$

where:

- V = volume of the diluted exhaust gas expressed in litres per test (prior to correction),
 V_o = volume of gas delivered by the positive displacement pump on testing conditions in litres per revolution,
 N = number of revolutions per test.
- 1.2.3. Correction of the diluted exhaust-gas volume to standard conditions. The diluted exhaust-gas volume is corrected by means of the following formula:

$$V_{\text{mix}} = V \cdot K_1 \cdot \frac{P_B - P_1}{T_p} \quad (2)$$

in which:

$$K_1 = \frac{273,2 \text{ K}}{101,33 \text{ kPa}} = 2,6961 \text{ (K} \cdot \text{kPa}^{-1}) \quad (3)$$

where:

- P_B = barometric pressure in the test room in kPa,
 P_1 = vacuum at the inlet to the positive displacement pump in kPa relative to the ambient barometric pressure,
 T_p = average temperature of the diluted exhaust gas entering the positive displacement pump during the test (K).

▼ M91.3. **Calculation of the corrected concentration of pollutants in the sampling bag**

$$C_i = C_e - C_d \left(1 - \frac{1}{DF}\right) \quad (4)$$

where:

C_i = concentration of the pollutant i in the diluted exhaust gas, expressed in ppm and corrected by the amount of i contained in the dilution air,

C_e = measured concentration of pollutant i in the diluted exhaust gas, expressed in ppm,

C_d = measured concentration of pollutant i in the air used for dilution, expressed in ppm,

DF = dilution factor.

▼ M14

The dilution factor is calculated as follows:

$$DF = \frac{13,4}{C_{CO_2} + (C_{HC} + C_{CO}) 10^{-4}} \text{ for petrol and diesel fuel (5a)}$$

$$DF = \frac{11,9}{C_{CO_2} + (C_{HC} + C_{CO}) 10^{-4}} \text{ for LPG (5b)}$$

$$DF = \frac{9,5}{C_{CO_2} + (C_{HC} + C_{CO}) 10^{-4}} \text{ for natural gas (5c)}$$

▼ M9

in this equation:

C_{CO_2} = concentration of CO_2 in the diluted exhaust gas contained in the sampling bag, expressed in % volume,

C_{HC} = concentration of HC in the diluted exhaust gas contained in the sampling bag, expressed in ppm carbon equivalent,

C_{CO} = concentration of CO in the diluted exhaust gas contained in the sampling bag, expressed in ppm.

1.4. **Determination of the NO humidity correction factor**

In order to correct the influence of humidity on the results of oxides of nitrogen, the following calculations are applied:

$$k_H = \frac{1}{1 - 0,0329 (H - 10,71)} \quad (6)$$

in which:

$$H = \frac{6,211 \cdot R_a \cdot P_d}{P_B - P_d \cdot R_a \cdot 10^{-2}}$$

where:

H = absolute humidity expressed in grams of water per kilogram of dry air,

R_a = relative humidity of the ambient air expressed as a percentage,

P_d = saturation vapour pressure at ambient temperature expressed in kPa,

P_B = atmospheric pressure in the room, expressed in kPa.

1.5. **Example**1.5.1. *Data*

1.5.1.1. Ambient conditions:

▼ **M9**

ambient temperature: 23 °C = 296,2 K,

barometric pressure: $P_B = 101,33$ kPa,

relative humidity: $R_a = 60$ %,

▼ **M12**

saturation vapour pressure: $P_d = 2,81$ kPa of H₂O at 23 °C.

▼ **M9**

1.5.1.2. Volume measured and reduced to standard conditions (paragraph 1)

$$V = 51,961 \text{ m}^3$$

1.5.1.3. Analyzer readings:

| | Diluted exhaust | Dilution-air |
|-------------------|-----------------|--------------|
| HC ⁽¹⁾ | 92 ppm | 3,0 ppm |
| CO | 470 ppm | 0 ppm |
| NO _x | 70 ppm | 0 ppm |
| CO ₂ | 1,6 % vol | 0,03 % vol |

⁽¹⁾ In ppm carbon equivalent.

1.5.2. *Calculation*

▼ **M12**

1.5.2.1. Humidity correction factor (K_H) (see formula (6))

$$H = \frac{6,211 \cdot R_a \cdot P_d}{P_B - P_d \cdot R_a \cdot 10^{-2}}$$

$$H = \frac{6,211 \cdot 60 \cdot 3,2}{101,33 - (2,81 \cdot 0,6)}$$

$$H = 10,5092$$

$$k_H = \frac{1}{1 - 0,0329 \cdot (H - 10,71)}$$

$$k_H = \frac{1}{1 - 0,0329 \cdot (10,5092 - 10,71)}$$

$$k_H = 0,9934$$

▼ **M9**

1.5.2.2. Dilution factor (DF) (see formula (5))

$$DF = \frac{13,4}{C_{CO_2} + (C_{HC} + C_{CO}) 10^{-4}}$$

$$DF = \frac{13,4}{1,6 + (92 + 4,70) 10^{-4}}$$

$$DF = 8,091$$

1.5.2.3. Calculation of the corrected concentration of pollutants in the sampling bag:

HC, mass emissions (see formulae (4) and (1))

$$C_i = C_e - C_d \left(1 - \frac{1}{DF} \right)$$

$$C_i = 92 - 3 \left(1 - \frac{1}{8,091} \right)$$

$$C = 89,371$$

▼ M9

$$M_{\text{HC}} = C_{\text{HC}} \cdot V_{\text{mix}} \cdot Q_{\text{HC}} \cdot \frac{1}{d}$$

▼ M14

$Q_{\text{HC}} = 0.619$ in the case of petrol or diesel

$Q_{\text{HC}} = 0.649$ in the case of LPG

$Q_{\text{HC}} = 0.714$ in the case of NG

▼ M9

$$M_{\text{HC}} = 89,371 \cdot 51,961 \cdot 0,619 \cdot 10^{-6} \cdot \frac{1}{d}$$

$$M_{\text{HC}} = \frac{2,88}{d} \text{ g/km}$$

CO, mass emissions (see formula (1))

$$M_{\text{CO}} = C_{\text{CO}} \cdot V_{\text{mix}} \cdot Q_{\text{CO}} \cdot \frac{1}{d}$$

$$Q_{\text{CO}} = 1,25$$

$$M_{\text{CO}} = 470 \cdot 51,961 \cdot 1,25 \cdot 10^{-6} \cdot \frac{1}{d}$$

$$M_{\text{CO}} = \frac{30,5}{d} \text{ g/km}$$

NO_x mass emissions (see formula (1))

$$M_{\text{NO}_x} = C_{\text{NO}_x} \cdot V_{\text{mix}} \cdot Q_{\text{NO}_x} \cdot k_{\text{H}} \cdot \frac{1}{d}$$

$$Q_{\text{NO}_x} = 2,05$$

▼ M12

$$M_{\text{NOX}} = 70 \cdot 51961 \cdot 2,05 \cdot 0,9934 \cdot 10^{-6} \cdot \frac{1}{d}$$

$$M_{\text{NOX}} = \frac{7,41}{d} \text{ g/km}$$

▼ M9

2. SPECIAL PROVISIONS RELATING TO VEHICLES
EQUIPPED WITH COMPRESSION-IGNITION ENGINES

2.1. **HC measurement for compression-ignition engines**

The average HC concentration used in determining the HC mass emissions from compression-ignition engines is calculated with the aid of the following formula:

$$c_e = \frac{\int_{t_1}^{t_2} c_{\text{HC}} \cdot dt}{t_2 - t_1} \quad (7)$$

where:

$\int_{t_1}^{t_2} C_{\text{HC}} \cdot dt$ = integral of the recording of the heated FID over the test ($t_2 - t_1$),

▼ M9

C_e = concentration of HC measured in the diluted exhaust in ppm of C_p ,

C_i is substituted directly for C_{HC} in all relevant equations.

2.2. **Determination of particulates**

Particulate emission M_p (g/km) is calculated by means of the following equation:

$$M_p = \frac{(V_{mix} + V_{ep}) \cdot P_e}{V_{ep} \cdot d}$$

where exhaust gases are vented outside tunnel,

$$M_p = \frac{V_{mix} \cdot P_e}{V_{ep} \cdot d}$$

where exhaust gases are returned to the tunnel,

where:

V_{mix} : volume of diluted exhaust gases (see 1.1), under standard conditions,

V_{ep} : volume of exhaust gas flowing through particulate filter under standard conditions,

P_e : particulate mass collected by filters,

d : actual distance corresponding to the operating cycle in km,

M_p : particulate emission in g/km.

▼ M9*ANNEX IV***TYPE II TEST****(Carbon monoxide emission test at idling speed)**

1. INTRODUCTION
This Annex describes the procedure for the type II test defined in 5.3.2 of Annex I.

2. CONDITIONS OF MEASUREMENT
2.1. The fuel must be the reference fuel, specifications for which are given in Annex VIII.

▼ M10

2.2. During the test, the environmental temperature must be between 293 and 303 K (20 and 30 °C).
The engine shall be warmed up until all temperatures of cooling and lubrication means and the pressure of lubrication means have reached equilibrium.

▼ M14

2.2.1. Vehicles that are fuelled either with petrol or with LPG or NG shall be tested with the reference fuel(s) used for the type I test.

▼ M9

2.3. In the case of vehicles with manually operated or semi-automatic-shift gearboxes the test must be carried out with the gear lever in the 'neutral' position and with the clutch engaged.

2.4. In the case of vehicles with automatic gear-boxes the test is carried out with the gear selector in either the 'neutral' or the 'parking' position.

2.5. Components for adjusting the idling speed**2.5.1. *Definition***

For the purposes of this Directive, 'components for adjusting the idling speed' means controls for changing the idling conditions of the engine which may be easily operated by a mechanic using only the tools described in 2.5.1.1. In particular, devices for calibrating fuel and air flows are not considered as adjustment components if their setting requires the removal of the set-stops, an operation which cannot normally be performed except by a professional mechanic.

2.5.1.1. Tools which may be used to control components for adjusting the idling speed: screwdrivers (ordinary or cross-headed), spanners (ring, open-end or adjustable), pliers, Allen keys.

2.5.2. *Determination of measurement points***▼ M10**

2.5.2.1. A measurement at the setting in accordance with the conditions fixed by the manufacturer is performed first.

▼ M9

2.5.2.2. For each adjustment component with a continuous variation, a sufficient number of characteristic positions are determined.

2.5.2.3. The measurement of the carbon-monoxide content of exhaust gases must be carried out for all the possible positions of the adjustment components, but for components with a continuous variation only the positions defined in 2.5.2.2 are adopted.

2.5.2.4. The type II test is considered satisfactory if at least one of the two following conditions is met:

2.5.2.4.1. none of the values measured in accordance with 2.5.2.3 exceeds the limit values;

2.5.2.4.2. the maximum content obtained by continuously varying one of the adjustment components while the other components are kept stable does not exceed the limit value, this condition being met for the various combinations of adjustment components other than the one which was varied continuously.

▼M9

- 2.5.2.5. The possible positions of the adjustment components are limited:
- 2.5.2.5.1. on the one hand, by the larger of the following two values: the lowest idling speed which the engine can reach; the speed recommended by the manufacturer, minus 100 revolutions per minute;
- 2.5.2.5.2. on the other hand, by the smallest of the following three values: the highest speed the engine can attain by activation of the idling speed components; the speed recommended by the manufacturer, plus 250 revolutions per minute; the cut-in speed of automatic clutches.
- 2.5.2.6. In addition, settings incompatible with correct running of the engine must not be adopted as measurement settings. In particular, when the engine is equipped with several carburettors all the carburettors must have the same setting.

3. SAMPLING OF GASES

- 3.1. The sampling probe is placed in the pipe connecting the exhaust with the sampling bag and as close as possible to the exhaust.
- 3.2. The concentration in CO (C_{CO}) and CO₂ (C_{CO_2}) is determined from the measuring instrument readings or recordings, by use of appropriate calibration curves.
- 3.3. The corrected concentration for carbon monoxide regarding four-stroke engines is:

$$C_{COcorr} = C_{CO} \frac{15}{C_{CO} + C_{CO_2}} \text{ (Vol. \%)}$$

- 3.4. The concentration in C_{CO} (see 3.2) measured according to the formulae contained in 3.3 need not be corrected if the total of the concentrations measured ($C_{CO} + C_{CO_2}$) is at least 15 for four-stroke engines.

▼ **M9**

ANNEX V

TYPE III TEST**(Verifying emissions of crankcase gases)**

1. INTRODUCTION

This Annex describes the procedure for the type III test defined in section 5.3.3 of Annex I.

2. GENERAL PROVISIONS

▼ **M10**

- 2.1. The type III test is carried out on the vehicle with a positive-ignition engine which has been subjected to the type I or type III test as applicable.

▼ **M9**

- 2.2. The engines tested must include leak-proof engines other than those so designed that even a slight leak may cause unacceptable operating faults (such as flat-twin engines).

3. TEST CONDITIONS

- 3.1. Idling must be regulated in conformity with the manufacturer's recommendations.

- 3.2. The measurements are performed in the following three sets of conditions of engine operation:

| Condition No | Vehicle speed (km/h) |
|--------------|---------------------------------|
| 1 | Idling |
| 2 | 50 ± 2 (in 3rd gear or 'drive') |
| 3 | 50 ± 2 (in 3rd gear or 'drive') |

| Condition No | Power absorbed by brake |
|--------------|--|
| 1 | Nil |
| 2 | That corresponding to the settings for ► M12 type I test at 50 km/h ◀ |
| 3 | That for conditions No 2, multiplied by a factor of 1,7 |

4. TEST METHOD

- 4.1. For the operation conditions as listed in 3.2 reliable function of the crankcase ventilation system must be checked.

5. METHOD OF VERIFICATION OF THE CRANKCASE VENTILATION SYSTEM
(Refer also to Figure V.5.)

- 5.1. The engine's apertures must be left as found.
- 5.2. The pressure in the crankcase is measured at an appropriate location. It is measured at the dipstick hole with an inclined-tube manometer.
- 5.3. The vehicle is deemed satisfactory if, in every condition of measurement defined in 3.2, the pressure measured in the crankcase does not exceed the atmospheric pressure prevailing at the time of measurement.
- 5.4. For the test by the method described above, the pressure in the intake manifold is measured to within ± 1 kPa.
- 5.5. The vehicle speed as indicated at the dynamometer is measured to within ± 2 km/h.

▼M9

- 5.6. The pressure measured in the crankcase is measured to within $\pm 0,01$ kPa.
- 5.7. If in one of the conditions of measurement defined in 3.2 the pressure measured in the crankcase exceeds the atmospheric pressure, an additional test as defined in section 6 is performed if so requested by the manufacturer.
6. **ADDITIONAL TEST METHOD**
 - 6.1. The engine's apertures must be left as found.
 - 6.2. A flexible bag impervious to crankcase gases and having a capacity of approximately five litres is connected to the dipstick hole. The bag must be empty before each measurement.
 - 6.3. The bag must be closed before each measurement. It must be opened to the crankcase for five minutes for each condition of measurement prescribed in 3.2.
 - 6.4. The vehicle is deemed satisfactory if in every condition of measurement defined in 3.2 no visible inflation of the bag occurs.
 - 6.5. **Remark**
 - 6.5.1. If the structural layout of the engine is such that the test cannot be performed by the methods described in section 6, the measurements must be effected by that method modified as follows:
 - 6.5.2. before the test, all apertures other than that required for the recovery of the gases are closed;
 - 6.5.3. the bag is placed on a suitable take-off which does not introduce any additional loss of pressure and is installed on the recycling circuit of the device directly at the engine-connection aperture.

▼M9

Figure V.5.
Type III test

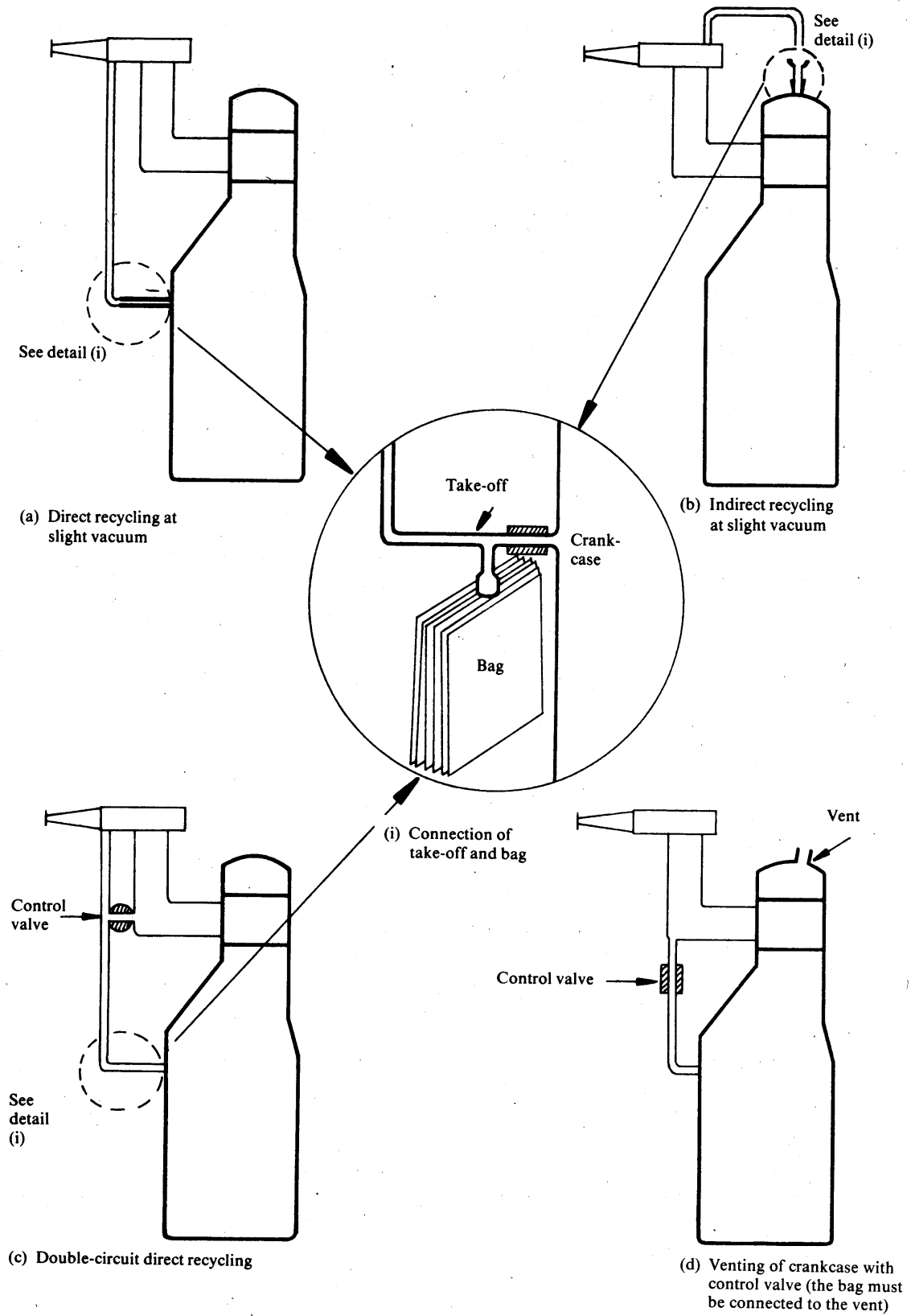

▼ **M9**

ANNEX VI

TYPE IV TEST

THE DETERMINATION OF EVAPORATIVE EMISSIONS FROM VEHICLES WITH SPARK-IGNITION ENGINES

▼ **M15**

1. INTRODUCTION

This Annex describes the procedure for the Type IV test in accordance with section 5.3.4 of Annex I.

This procedure describes a method for a determination of the loss of hydrocarbons by evaporation from the fuel systems of vehicles with positive-ignition engines.

2. DESCRIPTION OF TEST

The evaporative emission test (Figure VI.1) is designed to determine hydrocarbon evaporative emissions as a consequence of diurnal temperatures fluctuation, hot soaks during parking, and urban driving. The test consists of these phases:

- test preparation including an urban (Part One) and extra-urban (Part Two) driving cycle,
- hot soak loss determination,
- diurnal loss determination.

Mass emissions of hydrocarbons from the hot soak and the diurnal loss phases are added up to provide an overall result for the test.

3. VEHICLE AND FUEL

3.1. **Vehicle**

- 3.1.1. The vehicle must be in good mechanical condition and have been run in and driven at least 3 000 km before the test. The evaporative emission control system must be connected and have been functioning correctly over this period and the carbon canister(s) must have been subject to normal use, neither undergoing abnormal purging nor abnormal loading.

3.2. **Fuel**

- 3.2.1. The appropriate reference fuel must be used, as defined in Annex IX to this Directive.

4. TEST EQUIPMENT FOR EVAPORATIVE TEST

4.1. **Chassis dynamometer**

The chassis dynamometer must meet the requirements of Annex III.

4.2. **Evaporative emission measurement enclosure**

The evaporative emission measurement enclosure must be a gas-tight rectangular measuring chamber able to contain the vehicle under test. The vehicle must be accessible from all sides and the enclosure when sealed must be gas tight in accordance with Appendix 1. The inner surface of the enclosure must be impermeable and non-reactive to hydrocarbons. The temperature conditioning system must be capable of controlling the internal enclosure air temperature to follow the prescribed temperature versus time profile throughout the test, and an average tolerance of ± 1 K over the duration of the test.

The control system must be tuned to provide a smooth temperature pattern that has a minimum of overshoot, hunting, and instability about the desired long-term ambient temperature profile. Interior surface temperatures must not be less than 278 °K (5 °C) nor more than 320 °K (55 °C) at any time during the diurnal emission test.

▼ **M15**

Wall design must be such as to promote good dissipation of heat. Interior surface temperatures must not be below 293 °K (20 °C), nor above 325 °K (52 °C) for the duration of the hot soak test.

To accommodate the volume changes due to enclosure temperature changes, either a variable-volume or fixed-volume enclosure may be used.

4.2.1. *Variable-volume enclosure*

The variable-volume enclosure expands and contracts in response to the temperature change of the air mass in the enclosure. Two potential means of accommodating the internal volume changes are movable panel(s), or a bellows design, in which an impermeable bag or bags inside the enclosure expand(s) and contract(s) in response to internal pressure changes by exchanging air from outside the enclosure. Any design for volume accommodation must maintain the integrity of the enclosure as specified in Appendix 1 over the specified temperature range.

Any method of volume accommodation must limit the differential between the enclosure internal pressure and the barometric pressure to a maximum value of ± 5 hPa.

The enclosure must be capable of latching to a fixed volume. A variable volume enclosure must be capable of accommodating a ± 7 % change from its 'nominal volume' (see Appendix 1 section 2.1.1), taking into account temperature and barometric pressure variation during testing.

4.2.2. *Fixed-volume enclosure*

The fixed-volume enclosure must be constructed with rigid panels that maintain a fixed enclosure volume, and meet the requirements below.

4.2.2.1. The enclosure must be equipped with an outlet flow stream that withdraws air at a low, constant rate from the enclosure throughout the test. An inlet flow stream may provide make-up air to balance the outgoing flow with incoming ambient air. Inlet air must be filtered with activated carbon to provide a relatively constant hydrocarbon level. Any method of volume accommodation must maintain the differential between the enclosure internal pressure and the barometric pressure between 0 and -5 hPa.

4.2.2.2. The equipment must be capable of measuring the mass of hydrocarbon in the inlet and outlet flow streams with a resolution of 0,01 gram. A bag sampling system may be used to collect a proportional sample of the air withdrawn from and admitted to the enclosure. Alternatively, the inlet and outlet flow streams may be continuously analysed using an on-line FID analyser and integrated with the flow measurements to provide a continuous record of the mass hydrocarbon removal.

4.3. **Analytical systems**4.3.1. *Hydrocarbon analyser*

4.3.1.1. The atmosphere within the chamber is monitored using a hydrocarbon detector of the flame ionization detector (FID) type. Sample gas must be drawn from the mid-point of one side wall or roof of the chamber and any bypass flow must be returned to the enclosure, preferably to a point immediately downstream of the mixing fan.

4.3.1.2. The hydrocarbon analyser must have a response time to 90 % of final reading of less than 1,5 seconds. Its stability must be better than 2 % of full scale at zero and at 80 ± 20 % of full scale over a 15-minute period for all operational ranges.

4.3.1.3. The repeatability of the analyser expressed as one standard deviation must be better than 1 % of full scale deflection at zero and at 80 ± 20 % of full scale on all ranges used.

4.3.1.4. The operational ranges of the analyser must be chosen to give best resolution over the measurement, calibration and leak checking procedures.

4.3.2. *Hydrocarbon analyser data recording system*

4.3.2.1. The hydrocarbon analyser must be fitted with a device to record electrical signal output either by strip chart recorder or other data

▼ M15

processing system at a frequency of at least once per minute. The recording system must have operating characteristics at least equivalent to the signal being recorded and must provide a permanent record of results. The record must show a positive indication of the beginning and end of the hot soak or diurnal emission test (including beginning and end of sampling periods along with the time elapsed between start and completion of each test).

▼M15

Figure VI.1

Evaporative emission determination

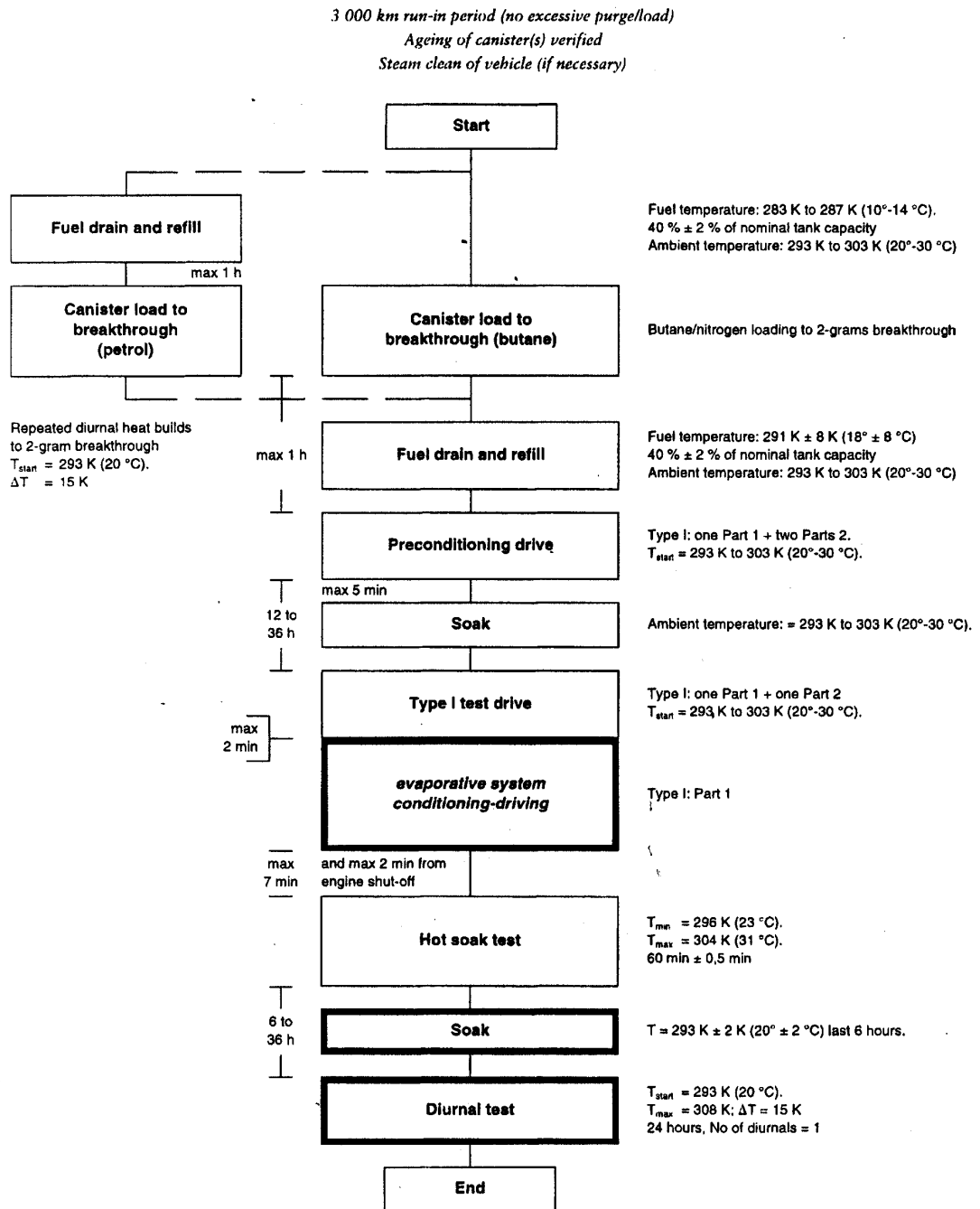

Note:

1. Evaporative emission control families — details clarified.
2. Tailpipe emissions may be measured during type I test drive, but these are not used for legislative purposes. Exhaust emission legislative test remains separate.

▼ **M15****4.4. Fuel tank heating (only applicable for gasoline canister load option)**

- 4.4.1. The fuel in the vehicle tank(s) must be heated by a controllable source of heat; for example a heating pad of 2 000 W capacity is suitable. The heating system must apply heat evenly to the tank walls beneath the level of the fuel so as not to cause local overheating of the fuel. Heat must not be applied to the vapour in the tank above the fuel.
- 4.4.2. The tank heating device must make it possible to heat the fuel in the tank evenly by 14 °K from 289 °K (16 °C) within 60 minutes, with the temperature sensor position as in 5.1.1. The heating system must be capable of controlling the fuel temperature to $\pm 1,5$ °K of the required temperature during the tank heating process.

4.5. Temperature recording

- 4.5.1. The temperature in the chamber is recorded at two points by temperature sensors which are connected so as to show a mean value. The measuring points are extended approximately 0,1 m into the enclosure from the vertical centre line of each side wall at a height of $0,9 \pm 0,2$ m.
- 4.5.2. The temperatures of the fuel tank(s) are recorded by means of the sensor positioned in the fuel tank as in 5.1.1 in the case of use of the gasoline canister load option (5.1.5).
- 4.5.3. Temperatures must, throughout the evaporative emission measurements, be recorded or entered into a data processing system at a frequency of at least once per minute.
- 4.5.4. The accuracy of the temperature recording system must be within $\pm 1,0$ °K and the temperature must be capable of being resolved to $\pm 0,4$ °K.
- 4.5.5. The recording or data processing system must be capable of resolving time to ± 15 seconds.

4.6. Pressure recording

- 4.6.1. The difference Δp between barometric pressure within the test area and the enclosure internal pressure must, throughout the evaporative emission measurements, be recorded or entered into a data processing system at a frequency of at least once per minute.
- 4.6.2. The accuracy of the pressure recording system must be within ± 2 hPa and the pressure must be capable of being resolved to $\pm 0,2$ hPa.
- 4.6.3. The recording or data processing system must be capable of resolving time to ± 15 seconds.

4.7. Fans

- 4.7.1. By the use of one or more fans or blowers with the SHED door(s) open it must be possible to reduce the hydrocarbon concentration in the chamber to the ambient hydrocarbon level.
- 4.7.2. The chamber must have one or more fans or blowers of likely capacity $0,1$ to $0,5$ m³s⁻¹ with which to thoroughly mix the atmosphere in the enclosure. It must be possible to attain an even temperature and hydrocarbon concentration in the chamber during measurements. The vehicle in the enclosure must not be subjected to a direct stream of air from the fans or blowers.

4.8. Gases

- 4.8.1. The following pure gases must be available for calibration and operation:
- purified synthetic air (purity: < 1 ppm C₁ equivalent ≤ 1 ppm CO, ≤ 400 ppm CO₂, $\leq 0,1$ ppm NO); oxygen content between 18 % and 21 % by volume,
 - hydrocarbon analyser fuel gas (40 % ± 2 % hydrogen, and balance helium with less than 1 ppm C₁ equivalent hydrocarbon, less than 400 ppm CO₂),
 - propane (C₃H₈), 99,5 % minimum purity,

▼ **M15**

- butane (C₄H₁₀), 98 % minimum purity,
 - nitrogen (N₂), 98 % minimum purity.
- 4.8.2. Calibration and span gases must be available containing mixtures of propane (C₃H₈) and purified synthetic air. The true concentrations of a calibration gas must be within ± 2 % of stated figures. The accuracy of the diluted gases obtained when using a gas divider must be to within ± 2 % of the true value. The concentrations specified in Appendix 1 may also be obtained by the use of a gas divider using synthetic air as the diluent gas.
- 4.9. **Additional equipment**
- 4.9.1. The absolute humidity in the tests area must be measurable to within ± 5 %.
5. TEST PROCEDURE
- 5.1. **Test preparation**
- 5.1.1. The vehicle is mechanically prepared before the test as follows:
- the exhaust system of the vehicle must not exhibit any leaks,
 - the vehicle may be steam cleaned before the test,
 - in the case of use of the gasoline canister load option (5.1.5) the fuel tank of the vehicle must be equipped with a temperature sensor to enable the temperature to be measured at the mid-point of the fuel in the fuel tank when filled to 40 % of its capacity,
 - additional fittings, adapters or devices may be fitted to the fuel system in order to allow a complete draining of the fuel tank. For this purpose it is not necessary to modify the shell of the tank,
 - the manufacturer may propose a test method in order to take into account the loss of hydrocarbons by evaporation coming only from the fuel system of the vehicle.
- 5.1.2. The vehicle is taken into the test area where the ambient temperature is between 293 °K and 303 °K (20 and 30 °C).
- 5.1.3. The ageing of the canister(s) has to be verified. This may be done by demonstrating that it has accumulated a minimum of 3 000 km. If this demonstration is not given, the following procedure is used. In the case of a multiple canister system each canister must undergo the procedure separately.
- 5.1.3.1. The canister is removed from the vehicle. Special care must be taken during this step to avoid damage to components and the integrity of the fuel system.
- 5.1.3.2. The weight of the canister must be checked.
- 5.1.3.3. The canister is connected to a fuel tank, possibly an external one, filled with reference fuel, to 40 % volume of the fuel tank(s).
- 5.1.3.4. The fuel temperature in the fuel tank must be between 283 °K (10 °C) and 287 °K (14 °C).
- 5.1.3.5. The (external) fuel tank is heated from 288 °K to 318 °K (15 ° to 45 °C) (1 °C increase every 9 minutes).
- 5.1.3.6. If the canister reaches breakthrough before the temperature reaches 318 °K (45 °C), the heat source must be turned off. Then the canister is weighed. If the canister did not reach breakthrough during the heating to 318 °K (45 °C), the procedure from 5.1.3.3 must be repeated until breakthrough occurs.
- 5.1.3.7. Breakthrough may be checked as is described in 5.1.5 and 5.1.6 of this Annex, or with the use of another sampling and analytical arrangement capable of detecting the emission of hydrocarbons from the canister at breakthrough.
- 5.1.3.8. The canister must be purged with 25 ± 5 litres per minute with the emission laboratory air until 300 bed volume exchanges are reached.
- 5.1.3.9. The weight of the canister must be checked.
- 5.1.3.10. The steps of the procedure in 5.1.3.4 to 5.1.3.9 must be repeated nine times. The test may be terminated prior to that, after not less

▼ **M15**

than three ageing cycles, if the weight of the canister after the last cycles has stabilized.

- 5.1.3.11. The evaporative emission canister is reconnected and the vehicle restored to its normal operating condition.

- 5.1.4. One of the methods specified in 5.1.5 and 5.1.6 must be used to precondition the evaporative canister. For vehicles with multiple canisters, each canister must be preconditioned separately.

- 5.1.4.1. Canister emissions are measured to determine breakthrough.

Breakthrough is here defined as the point at which the cumulative quantity of hydrocarbons emitted is equal to 2 grams.

- 5.1.4.2. Breakthrough may be verified using the evaporative emission enclosure as described in 5.1.5 and 5.1.6 respectively. Alternatively, breakthrough may be determined using an auxiliary evaporative canister connected downstream of the vehicle's canister. The auxiliary canister must be well purged with dry air prior to loading.

- 5.1.4.3. The measuring chamber must be purged for several minutes immediately before the test until a stable background is obtained. The chamber air mixing fan(s) must be switched on at this time.

The hydrocarbon analyser must be zeroed and spanned immediately before the test.

- 5.1.5. *Canister loading with repeated heat builds to breakthrough*

- 5.1.5.1. The fuel tank(s) of the vehicle(s) is (are) emptied using the fuel tank drain(s). This must be done so as not to abnormally purge or abnormally load the evaporative control devices fitted to the vehicle. Removal of the fuel cap is normally sufficient to achieve this.

- 5.1.5.2. The fuel tank(s) is (are) refilled with test fuel at a temperature of between 283 °K to 287 °K (10 to 14 °C) to 40 % ± 2 % of the tank's normal volumetric capacity. The fuel cap(s) of the vehicle must be fitted at this point.

- 5.1.5.3. Within one hour of being refuelled the vehicle must be placed, with the engine shut off, in the evaporative emission enclosure. The fuel tank temperature sensor is connected to the temperature recording system. A heat source must be properly positioned with respect to the fuel tank(s) and connected to the temperature controller. The heat source is specified in 4.4. In the case of vehicles fitted with more than one fuel tank, all the tanks must be heated in the same way as described below. The temperatures of the tanks must be identical to within ± 1,5 °K.

- 5.1.5.4. The fuel may be artificially heated to the starting diurnal temperature of 293 °K (20 °C) ± 1 °K.

- 5.1.5.5. When the fuel temperature reaches at least 292 °K (19 °C), the following steps must be taken immediately: the purge blower must be turned off; enclosure doors closed and sealed; and measurement initiated of the hydrocarbon level in the enclosure.

- 5.1.5.6. When the fuel temperature of the fuel tank reaches 293 °K (20 °C) a linear heat build of 15 °K (15 °C) begins. The fuel must be heated in such a way that the temperature of the fuel during the heating conforms to the function below to within ± 1,5 °K. The elapsed time of the heat build and temperature rise is recorded.

$$T_r = T_0 + 0,2333 \times t$$

where:

T_r = required temperature (K);

T_0 = initial temperature (K);

t = time from start of the tank heat build in minutes.

- 5.1.5.7. As soon as breakthrough occurs or when the fuel temperature reaches 308 °K (35 °C), whichever occurs first, the heat source is turned off, the enclosure doors unsealed and opened, and the vehicle fuel tank cap(s) removed. If breakthrough has not occurred by the time the fuel temperature 308 °K (35 °C), the heat source is removed from the vehicle, the vehicle removed from the evaporative emission enclosure and the entire procedure outlined in 5.1.7 repeated until breakthrough occurs.

▼ **M15**

- 5.1.6. *Butane loading to breakthrough*
- 5.1.6.1. If the enclosure is used for the determination of the breakthrough (see 5.1.4.2) the vehicle must be placed, with the engine shut off, in the evaporative emission enclosure.
- 5.1.6.2. The evaporative emission canister must be prepared for the canister loading operation. The canister must not be removed from the vehicle, unless access to it in its normal location is so restricted that loading can only reasonably be accomplished by removing the canister from the vehicle. Special care must be taken during this step to avoid damage to the components and the integrity of the fuel system.
- 5.1.6.3. The canister is loaded with a mixture composed of 50 % butane and 50 % nitrogen by volume at a rate of 40 grams butane per hour.
- 5.1.6.4. As soon as the canister reaches breakthrough, the vapour source must be shut off.
- 5.1.6.5. The evaporative emission canister must then be reconnected and the vehicle restored to its normal operating condition.
- 5.1.7. *Fuel drain and refill*
- 5.1.7.1. The fuel tank(s) of the vehicle(s) is (are) emptied using the fuel tank drain(s). This must be done so as not to abnormally purge or abnormally load the evaporative control devices fitted to the vehicle. Removal of the fuel cap is normally sufficient to achieve this.
- 5.1.7.2. The fuel tank(s) is (are) refilled with test fuel at a temperature of between $291\text{ °K} \pm 8\text{ °K}$ ($18 \pm 8\text{ °C}$) to $40 \pm 2\%$ of the tank's normal volumetric capacity. The fuel cap(s) of the vehicle must be fitted at this point.
- 5.2. **Preconditioning drive**
- 5.2.1. Within one hour from the completing of canister loading in accordance with 5.1.5 or 5.1.6 the vehicle is placed on the chassis dynamometer and driven through one Part One and two Part Two driving cycles of Type I test as specified in Annex III. Exhaust emissions are not sampled during this operation.
- 5.3. **Soak**
- 5.3.1. Within five minutes of completing the preconditioning operation specified in 5.2.1 the engine bonnet must be completely closed and the vehicle driven off the chassis dynamometer and parked in the soak area. The vehicle is parked for a minimum of 12 hours and a maximum of 36 hours. The engine oil and coolant temperatures must have reached the temperature of the area or within $\pm 3\text{ °K}$ of it at the end of the period.
- 5.4. **Dynamometer test**
- 5.4.1. After conclusion of the soak period the vehicle is driven through a complete Type I test drive as described in Annex III (cold start urban and extra urban test). Then the engine is shut off. Exhaust emissions may be sampled during this operation but the results must not be used for the purpose of exhaust emission type-approval.
- 5.4.2. Within two minutes of completing the Type I test drive specified in 5.4.1 the vehicle is driven a further conditioning drive consisting of one urban test cycle (hot start) of a Type I test. Then the engine is shut off again. Exhaust emissions need not be sampled during this operation.
- 5.5. **Hot soak evaporative emissions test**
- 5.5.1. Before the completion of the conditioning drive the measuring chamber must be purged for several minutes until a stable hydrocarbon background is obtained. The enclosure mixing fan(s) must also be turned on at this time.
- 5.5.2. The hydrocarbon analyser must be zeroed and spanned immediately prior to the test.

▼ **M15**

- 5.5.3. At the end of the conditioning drive the engine bonnet must be completely closed and all connections between the vehicle and the test stand disconnected. The vehicle is then driven to the measuring chamber with a minimum use of the accelerator pedal. The engine must be turned off before any part of the vehicle enters the measuring chamber. The time at which the engine is switched off is recorded on the evaporative emission measurement data recording system and temperature recording begins. The vehicle's windows and luggage compartments must be opened at this stage, if not already opened.
- 5.5.4. The vehicle must be pushed or otherwise moved into the measuring chamber with the engine switched off.
- 5.5.5. The enclosure doors are closed and sealed gas-tight within two minutes of the engine being switched off and within seven minutes of the end of the conditioning drive.
- 5.5.6. The start of a $60 \pm 0,5$ minute hot soak period begins when the chamber is sealed. The hydrocarbon concentration, temperature and barometric pressure are measured to give the initial readings $C_{HC,i}$, P_i and T_i for the hot soak test. These figures are used in the evaporative emission calculation, section 6. The ambient SHED temperature T must not be less than 296 °K and no more than 304 °K during the 60-minute hot soak period.
- 5.5.7. The hydrocarbon analyser must be zeroed and spanned immediately before the end of the $60 \pm 0,5$ minute test period.
- 5.5.8. At the end of the $60 \pm 0,5$ minute test period the hydrocarbon concentration in the chamber must be measured. The temperature and the barometric pressure are also measured. These are the final readings $C_{HC,f}$, P_f and T_f for the hot soak test used for the calculation in section 6.
- 5.6. **Soak**
- 5.6.1. The test vehicle must be pushed or otherwise moved to the soak area without use of the engine and soaked for not less than 6 hours and not more than 36 hours between the end of the hot soak test and the start of the diurnal emission test. For at least 6 hours of this period the vehicle must be soaked at $293 \text{ °K} \pm 2 \text{ °K}$ ($20 \text{ °C} \pm 2 \text{ °C}$).
- 5.7. **Diurnal test**
- 5.7.1. The test vehicle must be exposed to one cycle of ambient temperature according to the profile specified in Appendix 2 with a maximum deviation of $\pm 2 \text{ °K}$ at any time. The average temperature deviation from the profile, calculated using the absolute value of each measured deviation, must not exceed 1 °K. Ambient temperature must be measured at least every minute. Temperature cycling begins when time $t_{\text{start}} = 0$, as specified in 5.7.6.
- 5.7.2. The measuring chamber must be purged for several minutes immediately before the test until a stable background is obtainable. The chamber mixing fan(s) must also be switched on at this time.
- 5.7.3. The test vehicle, with the engine shut off and the test vehicle windows and luggage compartment(s) opened must be moved into the measuring chamber. The mixing fan(s) must be adjusted in such a way as to maintain a minimum air circulation of 8 km/h under the fuel tank of the test vehicle.
- 5.7.4. The hydrocarbon analyser must be zeroed and spanned immediately before the test.
- 5.7.5. The enclosure doors must be closed and gas-tight sealed.
- 5.7.6. Within 10 minutes of closing and sealing the doors, the hydrocarbon concentration, temperature and barometric pressure are measured to give the initial readings $C_{HC,i}$, P_i and T_i for the diurnal test. This is the point where time $t_{\text{start}} = 0$.
- 5.7.7. The hydrocarbon analyser must be zeroed and spanned immediately before the end of the test.
- 5.7.8. The end of the emission sampling period occurs 24 hours \pm 6 minutes after the beginning of the initial sampling, as specified

▼ **M15**

in 5.7.6. The time elapsed is recorded. The hydrocarbon concentration, temperature and barometric pressure are measured to give the final readings $C_{HC,f}$, P_f and T_f for the diurnal test used for the calculation in section 6. This completes the evaporative emission test procedure.

6. CALCULATION

- 6.1. The evaporative emission tests described in section 5 allow the hydrocarbon emissions from the diurnal and hot soak phases to be calculated. Evaporative losses from each of these phases is calculated using the initial and final hydrocarbon concentrations, temperatures and pressures in the enclosure, together with the net enclosure volume.

The formula below is used:

$$M_{HC} = k \cdot V \cdot 10^{-4} \cdot \left(\frac{C_{HC,f} \cdot P_f}{T_f} - \frac{C_{HC,i} \cdot P_i}{T_i} \right) + M_{HC, out} - M_{HC, i}$$

where:

- M_{HC} = hydrocarbon mass in grams
 $M_{HC,out}$ = mass of hydrocarbon exiting the enclosure, in the case of fixed-volume enclosures for diurnal emission testing (grams).
 $M_{HC,i}$ = mass of hydrocarbon entering the enclosure, in the case of fixed-volume enclosures for diurnal emission testing (grams).
 C_{HC} = measured hydrocarbon concentration in the enclosure (ppm (volume) C_1 equivalent),
 V = net enclosure volume in cubic metres corrected for the volume of the vehicle, with the windows and the luggage compartment open. If the volume of the vehicle is not determined a volume of 1,42 m³ is subtracted.
 T = ambient chamber temperature, in °K,
 P = barometric pressure in kPA,
 H/C = hydrogen to carbon ration,
 k = $1,2 \cdot (12 + H/C)$;

where:

- i is the initial reading,
 f is the final reading,
 H/C is taken to be 2,33 for diurnal test losses,
 H/C is taken to be 2,20 for hot soak losses.

6.2. **Overall results of test**

The overall hydrocarbon mass emission for the vehicle is taken to be:

$$M_{total} = M_{DI} + M_{HS}$$

where:

- M_{total} = overall mass emissions of the vehicle (grams),
 M_{DI} = hydrocarbon mass emission for diurnal test (grams),
 M_{HS} = hydrocarbon mass emission for the hot soak (grams).

▼ **M9**

7. CONFORMITY OF PRODUCTION

- 7.1. For routine end-of-production-line testing, the holder of the approval may demonstrate compliance by sampling vehicles which shall meet the following requirements.

7.2. **Test for leakage**

- 7.2.1. Vents to the atmosphere from the emission control system shall be isolated.

▼ M9

- 7.2.2. A pressure of 370 ± 10 mm of H₂O must be applied to the fuel system.
- 7.2.3. The pressure must be allowed to stabilize prior to isolating the fuel system from the pressure source.
- 7.2.4. Following isolation of the fuel system, the pressure must not drop by more than 50 mm of H₂O in five minutes.

7.3. Test for venting

- 7.3.1. Vents to the atmosphere from the emission control must be isolated.
- 7.3.2. A pressure of 370 ± 10 mm of H₂O must be applied to the fuel system.
- 7.3.3. The pressure must be allowed to stabilize prior to isolating the fuel system from the pressure source.
- 7.3.4. The venting outlets from the emission control systems to the atmosphere must be reinstated to the production condition.
- 7.3.5. The pressure of the fuel system must drop to below 100 mm of H₂O in not less than 30 seconds but within two minutes.

▼ M12

- 7.3.6. At the request of the manufacturer the functional capacity for venting can be demonstrated by equivalent alternative procedure. The specific procedure should be demonstrated by the manufacturer to the technical service during the type approval procedure.

▼ M9**7.4. Purge test**

- 7.4.1. Equipment capable of detecting an airflow rate of 1,0 litres in one minute must be attached to the purge inlet and a pressure vessel of sufficient size to have negligible effect on the purge system must be connected via a switching valve to the purge inlet, or alternatively,
 - 7.4.2. the manufacturer may use a flow meter of his own choice, if acceptable to the competent authority.
- 7.4.3. The vehicle must be operated in such a manner that any design feature of the purge system that could restrict purge operation is detected and the circumstances noted.
- 7.4.4. Whilst the engine is operating within the bounds noted in 7.4.3, the air flow must be determined by either:
 - 7.4.4.1. the device indicated in 7.4.1 being switched in. A pressure drop from atmospheric to a level indicating that a volume of 1,0 litres of air has flowed into the evaporative emission control system within one minute must be observed; or
 - 7.4.4.2. if an alternative flow measuring device is used, a reading of no less than 1,0 litre per minute must be detectable.

▼ M12

- 7.4.4.3. At the request of the manufacturer an alternative purge test procedure can be used, if the procedure has been presented to and has been accepted by the technical service during the type approval procedure.

▼ M9

- 7.5. The competent authority which has granted type-approval may at any time verify the conformity control methods applicable to each production unit.
 - 7.5.1. The inspector must take a sufficiently large sample from the series.
 - 7.5.2. The inspector may test these vehicles by application of either 7.1.4 or 7.1.5 of Annex I.
 - 7.5.3. If in pursuance of section 7.1.5 of Annex I the vehicle's test result falls outside the agreed limits of section 5.3.4.2 of Annex I, the manufacturer may request that the approval procedure referred to in 7.1.4 of Annex I be applied.
 - 7.5.3.1. The manufacturer must not be allowed to adjust, repair or modify any of the vehicles, unless they failed to comply with the require-

▼M9

- ments of section 7.1.4 of Annex I and unless such work is documented in the manufacturer's vehicle assembly and inspection procedures.
- 7.5.3.2. The manufacturer may request a single re-test for a vehicle whose evaporative emission characteristics are likely to have changed due to his actions under 7.5.3.1.
- 7.6. If the requirements of 7.5 are not met, the competent authority must ensure that all necessary steps are taken to re-establish conformity of production as rapidly as possible.

▼ **M9***Appendix 1***CALIBRATION OF EQUIPMENT FOR EVAPORATIVE EMISSION TESTING**▼ **M15**

1. CALIBRATION FREQUENCY AND METHODS
 - 1.1. All equipment must be calibrated before its initial use and then calibrated as often as necessary and in any case in the month before type-approval testing. The calibration methods to be used are described in this Appendix.
 - 1.2. Normally the series of temperatures which are mentioned firstly must be used. The series of temperatures within square brackets may alternatively be used.
2. CALIBRATION OF THE ENCLOSURE
 - 2.1. **Initial determination of enclosure internal volume**
 - 2.1.1. Before its initial use, the internal volume of the chamber must be determined as follows. The internal dimensions of the chamber are carefully measured, allowing for any irregularities such as bracing struts. The internal volume of the chamber is determined from these measurements.

For variable-volume enclosures, the enclosure must be latched to a fixed volume when the enclosure is held at an ambient temperature of 303 °K (30 °C) [(302 °K (29 °C)]. This nominal volume must be repeatable within $\pm 0,5$ % of the reported value.
 - 2.1.2. The net internal volume is determined by subtracting 1,42 m³ from the internal volume of the chamber. Alternatively the volume of the test vehicle with the luggage compartment and windows open may be used instead of the 1,42 m³.
 - 2.1.3. The chamber must be checked as in 2.3. If the propane mass does not agree with the injected mass to within ± 2 % then corrective action is required.
 - 2.2. **Determination of chamber background emissions**

This operation determines that the chamber does not contain any materials that emit significant amounts of hydrocarbons. The check must be carried out at the enclosure's introduction to service, after any operations in the enclosure which may affect background emissions and at a frequency of at least once per year.
 - 2.2.1. Variable-volume enclosures may be operated in either latched or unlatched volume configuration, as described in 2.1.1. Ambient temperatures must be maintained at 308 °K ± 2 °K (35° ± 2 °C) [309 °K ± 2 °K (36° ± 2 °C)], throughout the 4-hour period mentioned below.
 - 2.2.2. Fixed volume enclosures must be operated with inlet and outlet flow streams closed. Ambient temperatures must be maintained at 308 °K ± 2 °K (35° ± 2 °C) [309 °K ± 2 °K (36° ± 2 °C)] throughout the four-hour period mentioned below.
 - 2.2.3. The enclosure may be sealed and the mixing fan operated for a period of up to 12 hours before the four-hour background sampling period begins.
 - 2.2.4. The analyser (if required) must be calibrated, then zeroed and spanned.
 - 2.2.5. The enclosure must be purged until a stable hydrocarbon reading is obtained, and the mixing fan turned on if not already on.
 - 2.2.6. The chamber is then sealed and the background hydrocarbon concentration, temperature and barometric pressure are measured. These are the initial readings $C_{HC,i}$, P_i and T_i used in the enclosure background calculation.
 - 2.2.7. The enclosure is allowed to stand undisturbed with the mixing fan on for a period of four hours.

▼ **M15**

- 2.2.8. At the end of this time the same analyser is used to measure the hydrocarbon concentration in the chamber. The temperature and the barometric pressure are also measured. These are the final readings $C_{HC,P}$, P_f and T_f .
- 2.2.9. The change in mass of hydrocarbons in the enclosure must be calculated over the time of the test in accordance with 2.4 and must not exceed 0,05 g.
- 2.3. **Calibration and hydrocarbon retention test of the chamber**
- The calibration and hydrocarbon retention test in the chamber provides a check on the calculated volume in 2.1 and also measures any leak rate. The enclosure leak rate must be determined at the enclosure's introduction to service, after any operations in the enclosure which may affect the integrity of the enclosure, and at least monthly thereafter. If six consecutive monthly retention checks are successfully completed without corrective action, the enclosure leak rate may be determined quarterly thereafter as long as no corrective action is required.
- 2.3.1. The enclosure must be purged until a stable hydrocarbon concentration is reached. The mixing fan is turned on, if not already switched on. The hydrocarbon analyser is zeroed, calibrated if required, and spanned.
- 2.3.2. On variable-volume enclosures the enclosure must be latched to the nominal volume position. On fixed-volume enclosures the outlet and inlet flow streams must be closed.
- 2.3.3. The ambient temperature control system is then turned on (if not already on) and adjusted for an initial temperature of 308 °K (35 °C) [309 °K (36 °C)].
- 2.3.4. When the enclosure stabilizes at 308 °K \pm 2 °K (35° \pm 2 °C) [309 °K \pm 2 °K (36° \pm 2 °C)], the enclosure is sealed and the background concentration, temperature and barometric pressure measured. These are the initial readings $C_{HC,i}$, P_i and T_i used in the enclosure calibration.
- 2.3.5. A quantity of approximately 4 grams of propane is injected into the enclosure. The mass of propane must be measured to an accuracy and precision of \pm 02, % of the measured value.
- 2.3.6. The contents of the chamber must be allowed to mix for five minutes and then the hydrocarbon concentration, temperature and barometric pressure are measured. These are the final readings $C_{HC,P}$, P_f and T_f for the calibration of the enclosure as well as the initial readings $C_{HC,i}$, P_i and T_i for the retention check.
- 2.3.7. On the basis of the readings taken in 2.3.4 and 2.3.6 and the formula in 2.4, the mass of propane in the enclosure is calculated. This must be within \pm 2 % of the mass of propane measured in 2.3.5..
- 2.3.8. For variable-volume enclosures the enclosure must be unlatched from the nominal volume configuration. For fixed-volume enclosures, the outlet and inlet flow streams must be opened.
- 2.3.9. The process is then begun of cycling the ambient temperature from 308 °K (35 °C) to 293 °K (20 °C) and back to 308 °K (35 °C) [308,6 °K (35,6 °C) to 295,2 °K (22,2 °C) and back to 308,6 °K (35,6 °C)] over a 24-hour period according to the profile [alternative profile] specified in Appendix 2 within 15 minutes of sealing the enclosure. (Tolerances as specified in section 5.7.1 of Annex VI).
- 2.3.10. At the completion of the 24-hour cycling period, the final hydrocarbon concentration, temperature and barometric pressure are measured and recorded. These are the final readings $C_{HC,P}$, T_f and P_f for the hydrocarbon retention check.
- 2.3.11. Using the formula in 2.4, the hydrocarbon mass is then calculated from the readings taken in 2.3.10 and 2.3.6. The mass may not differ by more than 3 % from the hydrocarbon mass given by 2.3.7.
- 2.4. **Calculations**
- The calculation of net hydrocarbon mass change within the enclosure is used to determine the chamber's hydrocarbon background

▼ **M15**

and leak rate. Initial and final readings of hydrocarbon concentration, temperature and barometric pressure are used in the following formula to calculate the mass change.

$$M_{\text{HC}} = k \cdot V \cdot 10^{-4} \cdot \left(\frac{C_{\text{HC}, f} \cdot P_f}{T_f} - \frac{C_{\text{HC}, i} \cdot P_i}{T_i} \right) + M_{\text{HC}, \text{out}} - M_{\text{HC}, i}$$

where:

- M_{HC} = hydrocarbon mass in grams
- $M_{\text{HC}, \text{out}}$ = mass of hydrocarbon exiting the enclosure, in the case of fixed-volume enclosures for diurnal emission testing (grams)
- $M_{\text{HC}, i}$ = mass of hydrocarbon entering the enclosure, in the case of fixed volume enclosures for diurnal emission testing (grams)
- C_{HC} = hydrocarbon concentration in the enclosure (ppm carbon (NB: ppm carbon = ppm propane \times 3))
- V = enclosure volume in cubic metres as measured in section 2.1.1.
- T = ambient temperature in the enclosure in K,
- P = barometric pressure in kPa,
- k = 17,6;

where:

- i is the initial reading.
- f is the final reading

▼ **M9**

3. CHECKING OF FID HYDROCARBON ANALYZER

3.1. **Detector response optimization**

The FID must be adjusted as specified by the instrument manufacturer. Propane in air should be used to optimize the response on the most common operating range.

3.2. **Calibration of the HC analyzer**

The analyzer should be calibrated using propane in air and purified synthetic air. See section 4.5.2 of Annex III (Calibration and span gases).

Establish a calibration curve as described in sections 4.1 to 4.5 of this Appendix.

3.3. **Oxygen interference check and recommended limits**

The response factor (Rf) for a particular hydrocarbon species is the ratio of the FID C_i reading to the gas cylinder concentration, expressed as ppm C_i .

The concentration of the test gas must be at a level to give a response of approximately 80 % of full scale deflection, for the operating range. The concentration must be known, to an accuracy of ± 2 % in reference to a gravimetric standard expressed in volume. In addition the gas cylinder must be preconditioned for 24 hours at a temperature between 293 K and 303 K (20 ° and 30 °C).

Response factors should be determined when introducing an analyzer into service and thereafter at major service intervals. The reference gas to be used is propane with balance purified air which is taken to give a response factor of 1,00.

The test gas to be used for oxygen interference and the recommended response factor range are given below:

Propane and nitrogen $0,95 \leq Rf \leq 1,05$.

▼M9

4. CALIBRATION OF THE HYDROCARBON ANALYZER

Each of the normally used operating ranges are calibrated by the following procedure:

- 4.1. Establish the calibration curve by at least five calibration points spaced as evenly as possible over the operating range. The nominal concentration of the calibration gas with the highest concentrations to be at least 80 % of the full scale.
- 4.2. Calculate the calibration curve by the method of least squares. If the resulting polynomial degree is greater than 3, then the number of calibration points must be at least the number of the polynomial degree plus 2.
- 4.3. The calibration curve must not differ by more than 2 % from the nominal value of each calibration gas.
- 4.4. Using the coefficients of the polynomial derived from 3.2, a table of indicated reading against true concentration shall be drawn up in steps of no greater than 1 % of full scale. This is to be carried out for each analyzer range calibrated. The table shall also contain other relevant data such as:
 - date of calibration,
 - span and zero potentiometer readings (where applicable),
 - nominal scale,
 - reference data of each calibration gas used,
 - the actual and indicated value of each calibration gas used together with the percentage differences,
 - FID fuel and type,
 - FID air pressure.
- 4.5. If it can be shown to the satisfaction of the Regulatory Agency that alternative technology (e.g. computer, electronically controlled range switch) can give equivalent accuracy, then those alternatives may be used.

▼ **M15***Appendix 2*

Diurnal ambient temperature profile for the calibration of the enclosure and the diurnal emission test

| Time (hours) | | Temperature (°C) |
|--------------|------|------------------|
| calibration | test | |
| 16 | 0 | 20 |
| 17 | 1 | 20,2 |
| 18 | 2 | 20,5 |
| 19 | 3 | 21,2 |
| 20 | 4 | 23,1 |
| 21 | 5 | 25,1 |
| 22 | 6 | 27,2 |
| 23 | 7 | 29,8 |
| 24 | 8 | 31,8 |
| 0 | 9 | 33,3 |
| 1 | 10 | 34,4 |
| 2 | 11 | 35 |
| 3 | 12 | 34,7 |
| 4 | 13 | 33,8 |
| 5 | 14 | 32 |
| 6 | 15 | 30 |
| 7 | 16 | 28,4 |
| 8 | 17 | 26,9 |
| 9 | 18 | 25,2 |
| 10 | 19 | 24 |
| 11 | 20 | 23 |
| 12 | 21 | 22 |
| 13 | 22 | 20,8 |
| 14 | 23 | 20,2 |
| 15 | 24 | 20 |

Alternative diurnal ambient temperature profile for the calibration of the enclosure in accordance with Appendix 1, sections 1.2 and 2.3.9

| Time (hours) | Temperature (°C) |
|--------------|------------------|
| 0 | 35,6 |
| 1 | 35,3 |
| 2 | 34,5 |
| 3 | 33,2 |
| 4 | 31,4 |
| 5 | 29,7 |
| 6 | 28,2 |
| 7 | 27,2 |
| 8 | 26,1 |
| 9 | 25,1 |
| 10 | 24,3 |
| 11 | 23,7 |
| 12 | 23,3 |
| 13 | 22,9 |
| 14 | 22,6 |
| 15 | 22,2 |
| 16 | 22,5 |
| 17 | 24,2 |
| 18 | 26,8 |
| 19 | 29,6 |
| 20 | 31,9 |
| 21 | 33,9 |
| 22 | 35,1 |
| 23 | 35,4 |
| 24 | 35,6 |

▼ **M15***ANNEX VII***TYPE VI TEST**

(Verifying the average low ambient temperature carbon monoxide and hydrocarbon tailpipe emissions after a cold start)

1. **INTRODUCTION**

This Annex applies only to vehicles with positive-ignition engines. It describes the equipment required and the procedure for the Type VI test defined in section 5.3.5 of Annex I in order to verify the emissions of carbon monoxide and hydrocarbons at low ambient temperatures. Topics addressed in this Annex include:

1. Equipment requirements;
2. Test conditions;
3. Test procedures and data requirements.

2. **TEST EQUIPMENT**2.1. **Summary**

- 2.1.1. This chapter deals with the equipment needed for low ambient temperature exhaust emission tests on positive-ignition vehicles. Equipment required and specifications are equivalent to the requirements for the Type I test as specified in Annex III, with appendices, if specific requirements for the Type VI test are not prescribed. Sections 2.2 to 2.6 describe deviations applicable to Type VI low ambient temperature testing.

2.2. **Chassis dynamometer**

- 2.2.1. The requirements of section 4.1 of Annex III apply. The dynamometer must be adjusted to simulate the operation of a vehicle on the road at 266 °K (−7 ° C). Such adjustment may be based on a determination of the road load force profile at 266 °K (−7 ° C). Alternatively the driving resistance determined according to Appendix 3 of Annex III may be adjusted for a 10 % decrease of the coast-down time. The technical service may approve the use of other methods of determining the driving resistance.
- 2.2.2. For calibration of the dynamometer the provisions of Appendix 2 of Annex III apply.

2.3. **Sampling system**

- 2.3.1. The provisions of section 4.2 of Annex III and Appendix 5 of Annex III apply. Section 2.3.2 in Appendix 5 is modified to read: 'The piping configuration, flow capacity of the CVS, and the temperature and specific humidity of the dilution air (which may be different from the vehicle combustion air source) must be controlled so as to virtually eliminate water condensation in the system (a flow of 0,142 to 0,165 m²/s is sufficient for most vehicles).'

2.4. **Analytical equipment**

- 2.4.1. The provisions of section 4.3 of Annex III apply, but only for carbon monoxide, carbon dioxide, and hydrocarbon testing.
- 2.4.2. For calibrations of the analytical equipment the provisions of Appendix 6 of Annex III apply.

2.5. **Gases**

- 2.5.1. The provisions of section 4.5 of Annex III apply, where they are relevant.

2.6. **Additional equipment**

- 2.6.1. For equipment used for the measurement of volume, temperature, pressure and humidity the provisions in sections 4.4 and 4.6 of Annex III apply.

▼M15

3. TEST SEQUENCE AND FUEL
 - 3.1. **General requirements**
 - 3.1.1. The test sequence in Figure VII.1 shows the steps encountered as the test vehicle undergoes the procedures for the Type VI test. Ambient temperature levels encountered by the test vehicle must average: $266\text{ °K }(-7\text{ °C}) \pm 3\text{ °K}$ and must:

not be less than $260\text{ °K }(-13\text{ °C})$, no more than $272\text{ °K }(-1\text{ °C})$.

The temperature may:

not fall below $263\text{ °K }(-10\text{ °C})$, or exceed $269\text{ °K }(-4\text{ °C})$

for more than three consecutive minutes.
 - 3.1.2. The test cell temperature monitored during testing must be measured at the output of the cooling fan (section 5.2.1 of this Annex). The ambient temperature reported must be an arithmetic average of the test cell temperatures measured at constant intervals no more than one minute apart.
 - 3.2. **Test procedure**

The part one urban driving cycle according to Figure III.1.1 in Annex III - Appendix 1, consists of four elementary urban cycles which together makes a complete part one cycle.

 - 3.2.1. Start of engine, start of the sampling and the operation of the first cycle must be in accordance with Table III.1.2 and Figure III.1.2.
 - 3.3. **Preparation for the test**
 - 3.3.1. For the test vehicle the provisions of section 3.1 of Annex III apply. For setting the equivalent inertia mass on the dynamometer the provisions of section 5.1 of Annex III apply.

▼M15

Figure VII.1

Procedure for low ambient temperature test

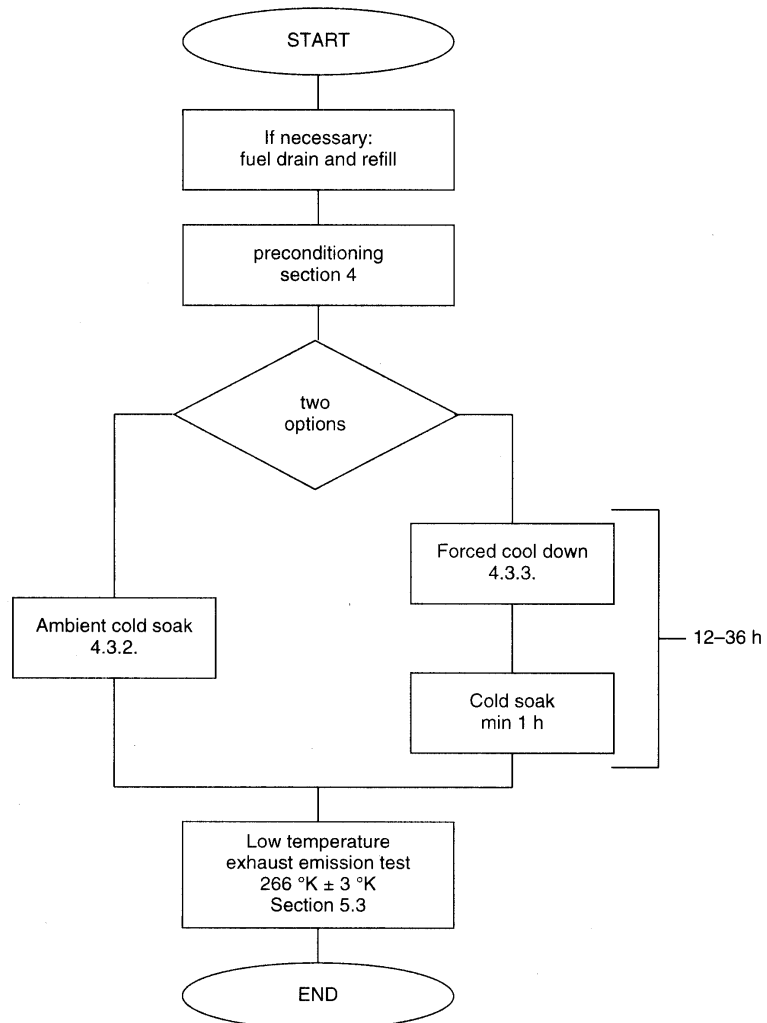

▼ **M15**

- 3.4. **Test fuel**
- 3.4.1. The test fuel used must have the specification that follows from the provisions in section 3 of Annex IX. A manufacturer may chose to use the test fuel specified in section 1 of Annex IX.
4. **VEHICLE PRECONDITIONING**
- 4.1. **Summary**
- 4.1.1. To ensure reproducible emission tests, the test vehicles must be conditioned in a uniform manner. The conditioning consists of a preparatory drive on a chassis dynamometer followed by a soak period before the emission test according to 4.3.
- 4.2. **Preconditioning**
- 4.2.1. The fuel tank(s) must be filled with the specified test fuel. If the existing fuel in the fuel tank(s) does not meet the specifications contained in 3.4.1, the existing fuel must be drained prior to the fuel fill. The test fuel must be at a temperature less than or equal to 289 °K (+ 16 °C). For the above operations the evaporative emission control system must neither be abnormally purged nor abnormally loaded.
- 4.2.2. The vehicle is moved to the test cell and placed on the chassis dynamometer.
- 4.2.3. The preconditioning consists of the driving cycle according to Annex III — Appendix 1 Figure III.1.1, parts one and two. At the request of the manufacturer, vehicles with a positive-ignition engine may be preconditioned with one Part I and two Part II driving cycles.
- 4.2.4. During the preconditioning the test cell temperature must remain relatively constant and not be higher than 303 °K (30 °C).
- 4.2.5. The drive-wheel tyre pressure must be set in accordance with the provisions of section 5.3.2 of Annex III.
- 4.2.6. Within ten minutes of completion of the preconditioning, the engine must be switched off.
- 4.2.7. If requested by the manufacturer and approved by the technical service, additional preconditioning may in exceptional cases be allowed. The technical service may also choose to conduct additional preconditioning. The additional preconditioning consists of one or more driving schedules of the part one cycle as described in Annex III — Appendix 1. The extent of such additional preconditioning must be recorded in the test report.
- 4.3. **Soak methods**
- 4.3.1. One of the following two methods, to be selected by the manufacturer, must be utilized to stabilize the vehicle before the emission test.
- 4.3.2. *Standard method.* The vehicle is stored for not less than 12 hours nor for more than 36 hours prior to the low ambient temperature tailpipe emission test. The ambient temperature (dry bulb) during this period must be maintained at an average temperature of:
- 266 °K (−7 °C) ± 3 °K during each hour of this period and must not be less than 260 °K (−13 °C) nor more than 272 (−1 °C). In addition, the temperature may not fall below 263 °K (−10 °C) nor more than 269 °K (−4 °C) for more than three consecutive minutes.
- 4.3.3. *Forced method*⁽¹⁾. The vehicle must be stored for not more than 36 hours prior to the low ambient temperature tailpipe emission test.
- 4.3.3.1. The vehicle must not be stored at ambient temperatures which exceed 303 °K (30 °C) during this period.

⁽¹⁾ The provisions concerning 'forced cool down methods' must be re-examined without delay in accordance with the procedure laid down in Article 13 of Directive 70/156/EEC.

▼ **M15**

- 4.3.3.2. Vehicle cooling may be accomplished by force-cooling the vehicle to the test temperature. If cooling is augmented by fans, the fans must be placed in a vertical position so that the maximum cooling of the drive train and engine is achieved and not primarily the sump. Fans must not be placed under the vehicle.
- 4.3.3.3. The ambient temperature need only be stringently controlled after the vehicle has been cooled to:
 $266\text{ °K }(-7\text{ °C}) \pm 2\text{ °K}$,
as determined by a representative bulk oil temperature. A representative bulk oil temperature is the temperature of the oil measured near the middle of the oil, not at the surface or at the bottom of the oil sump. If two or more diverse locations in the oil are monitored, they must all meet the temperature requirements.
- 4.3.3.4. The vehicle must be stored for at least one hour after it has been cooled to $266\text{ °K }(-7\text{ °C}) \pm 2\text{ °K}$, prior to the low ambient temperature tailpipe emission test. The ambient temperature (dry bulb) during this period must average $266\text{ °K }(-7\text{ °C}) \pm 3\text{ °K}$, and must:
not be less than $260\text{ °K }(-13\text{ °C})$ nor more than $272\text{ °K }(-1\text{ °C})$,
In addition, the temperature may:
not fall below $263\text{ °K }(-10\text{ °C})$ or exceed $269\text{ °K }(-4\text{ °C})$,
for more than three consecutive minutes.
- 4.3.4. If the vehicle is stabilized at $266\text{ °K }(-7\text{ °C})$, in a separate area and is moved through a warm area to the test cell, the vehicle must be restabilized in the test cell for at least six times the period the vehicle is exposed to warmer temperatures. The ambient temperature (dry bulb) during this period
must average $266\text{ °K }(-7\text{ °C}) \pm 3\text{ °K}$ and must not be less than $260\text{ °K }(-13\text{ °C})$ nor more than $272\text{ °K }(-1\text{ °C})$.
In addition, the temperature may:
not fall below $263\text{ °K }(-10\text{ °C})$ or exceed $269\text{ °K }(-4\text{ °C})$, for more than three consecutive minutes.

5. DYNAMOMETER PROCEDURE

5.1. **Summary**

- 5.1.1. The emission sampling is performed over a test procedure consisting of the part one cycle (Annex III — Appendix 1 Figure III.1.1). Engine start-up, immediate sampling, operation over the part one cycle and engine shut-down make a complete low ambient temperature test, with a total test time of 780 seconds. The tailpipe emissions are diluted with ambient air and a continuously proportional sample is collected for analysis. The exhaust gases collected in the bag are analysed for hydrocarbons, carbon monoxide, and carbon dioxide. A parallel sample of the dilution air is similarly analysed for carbon monoxide, hydrocarbons and carbon dioxide.

5.2. **Dynamometer operation**5.2.1. *Cooling fan*

- 5.2.1.1. A cooling fan is positioned so that cooling air is appropriately directed to the radiator (water cooling) or to the air intake (air-cooling) and to the vehicle.
- 5.2.1.2. For front-engined vehicles, the fan must be positioned in front of the vehicle, within 300 mm of it. In the case of rear-engined vehicles or if the above arrangement is impractical, the cooling fan must be positioned so that sufficient air is supplied to cool the vehicle.
- 5.2.1.3. The fan speed must be such that, within the operating range of 10 km/h to at least 50 km/h, the linear velocity of the air at the blower outlet is within $\pm 5\text{ km/h}$ of the corresponding roller

▼ **M15**

speed. The final selection of the blower must have the following characteristics:

- area: at least 0,2 m²,
- height of the lower edge above ground: approximately 20 cm.

As an alternative the blower speed must be at least 6 m/s (21,6 km/h). At the request of the manufacturer, for special vehicles (e. g. vans, off-road) the height of the cooling fan may be modified.

- 5.2.1.4. The vehicle speed as measured from the dynamometer roll(s) must be used (section 4.1.4.4 of Annex III).
- 5.2.3. Preliminary testing cycles may be carried out if necessary, to determine how best to actuate the accelerator and brake controls so as to achieve a cycle approximating to the theoretical cycle within the prescribed limits, or to permit sampling system adjustment. Such driving must be carried out before 'START' according to Figure VII.1.
- 5.2.4. Humidity in the air must be kept low enough to prevent condensation on the dynamometer roll(s).
- 5.2.5. The dynamometer must be thoroughly warmed as recommended by the dynamometer manufacturer, and using procedures or control methods that assure stability of the residual frictional horsepower.
- 5.2.6. The time between dynamometer warming and the start of the emission test must be no longer than 10 minutes if the dynamometer bearings are not independently heated. If the dynamometer bearings are independently heated, the emission test must begin no longer than 20 minutes after dynamometer warming.
- 5.2.7. If the dynamometer horsepower must be adjusted manually, it must be set within one hour prior to the tailpipe emission test phase. The test vehicle may not be used to make the adjustment. The dynamometer, using automatic control of preselectable power settings, may be set at any time prior to the beginning of the emission test.
- 5.2.8. Before the emission test driving schedule may begin, the test cell temperature must be 266 °K (-7 °C) ± 2 °K, as measured in the air stream of the cooling fan with a maximum distance of 1 m-1,5 m from the vehicle.
- 5.2.9. During operation of the vehicle the heating and defrosting devices must be shut off.
- 5.2.10. The total driving distance or roller revolutions measured are recorded.
- 5.2.11. A four-wheel drive vehicle must be tested in a two-wheel drive mode of operation. The determination of the total road force for dynamometer setting is performed while operating the vehicle in its primary designed driving mode.

5.3. **Performing the test**

- 5.3.1. The provisions of sections 6.2 to 6.6, excluding 6.2.2, of Annex III apply in respect of starting the engine, carrying out the test and taking the emission samples. The sampling begins before or at the initiation of the engine start-up procedure and ends on conclusion of the final idling period of the last elementary cycle of the part one (urban driving cycle), after 780 seconds.

The first driving cycle starts with a period of 11 seconds idling as soon as the engine has started.

- 5.3.2. For the analysis of the sampled emissions the provisions of section 7.2 of Annex III apply. In performing the exhaust sample analysis the technical service must exercise care to prevent condensation of water vapour in the exhaust gas sampling bags.
- 5.3.3. For the calculations of the mass emissions the provisions of section 8 of Annex III apply.

▼M15

6. OTHER REQUIREMENTS
 - 6.1. **Irrational emission control strategy**
 - 6.1.1. Any irrational emission control strategy which results in a reduction in effectiveness of the emission control system under normal operating conditions at low temperature driving, so far as not covered by the standardized emission tests, may be considered a defeat device.

▼ M9**ANNEX ► M15 VIII ◀****Description of the ageing test for verifying the durability of anti-pollution devices**

1. INTRODUCTION

This Annex described the test for verifying the durability of anti-pollution devices equipping vehicles with positive-ignition or compression-ignition engines during an ageing test of 80 000 km.

2. TEST VEHICLE

2.1. The vehicle must be in good mechanical order; the engine and the anti-pollution devices must be new.

The vehicle may be the same as that presented for the type I test; this type I test has to be done after the vehicle has run at least 3 000 km of the ageing cycle of section 5.1.

▼ M14

3. FUEL

The durability test is conducted with a suitable commercially available fuel.

▼ M9

4. VEHICLE MAINTENANCE AND ADJUSTMENTS

Maintenance, adjustments as well as the use of the test vehicle's controls shall be those recommended by the manufacturer.

5. VEHICLE OPERATION ON TRACK, ROAD OR ON CHASSIS DYNAMOMETER

5.1. **Operating cycle**

During operation on track, road or on roller test bench, the distance must be covered according to the driving schedule (Figure VII.5.1) described below:

- the durability test schedule is composed of 11 cycles covering 6 kilometres each,
- during the first nine cycles, the vehicle is stopped four times in the middle of the cycle, with the engine idling each time for 15 seconds,
- normal acceleration and deceleration,
- five decelerations in the middle of each cycle, dropping from cycle speed to 32 km/h, and the vehicle is gradually accelerated again until cycle speed is attained,
- the 10th cycle is carried out at a steady speed of 89 km/h,
- the 11th cycle begins with maximum acceleration from stop point up to 113 km/h. At half-way, braking is employed normally until the vehicle comes to a stop. This is followed by an idle period of 15 seconds and a second maximum acceleration.

The schedule is then restarted from the beginning. The maximum speed of each cycle is given in the following Table.

Table VII.5.1.

Maximum speed of each cycle

| Cycle | Cycle speed in km/h |
|-------|---------------------|
| 1 | 64 |
| 2 | 48 |
| 3 | 64 |
| 4 | 64 |
| 5 | 56 |
| 6 | 48 |
| 7 | 56 |
| 8 | 72 |

▼M9

| Cycle | Cycle speed in km/h |
|-------|------------------------|
| 9 | 56 |
| 10 | 89 |
| 11 | 113 |

▼M9

Figure VII.5.1
Driving schedule

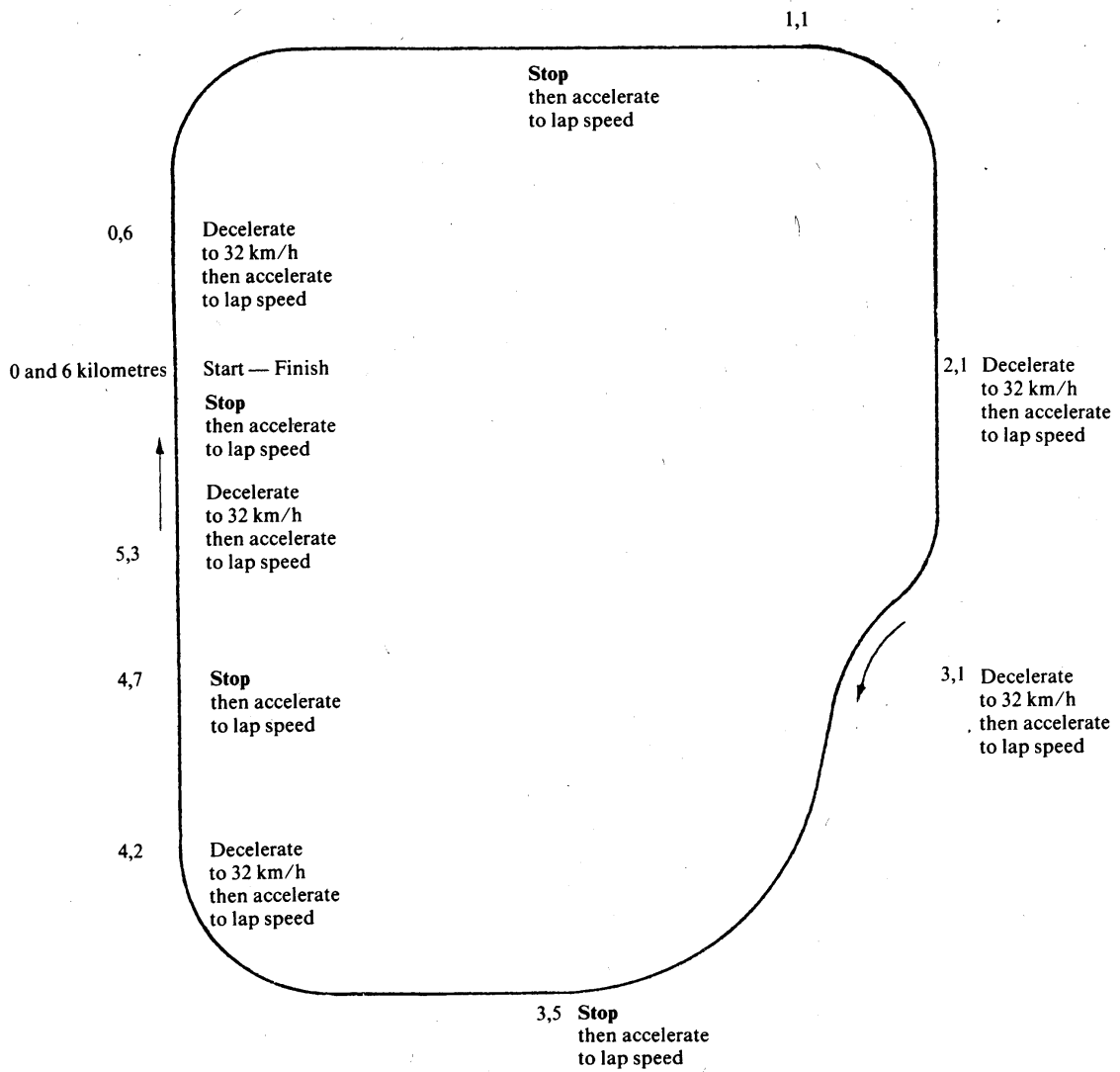

▼ M9

- 5.1.1. At the request of the manufacturer, an alternative road test schedule may be used. Such alternative test schedules shall be approved by the technical service in advance of the test and must have substantially the same average speed, distribution of speeds, number of stops per kilometres and number of accelerations per kilometres as the driving schedule used on track or roller test bench, as detailed in 5.1 and Figure VII.5.1.
- 5.1.2. The durability test, or if the manufacturer has chosen, the modified durability test shall be conducted until the vehicle has covered a minimum of 80 000 km.
- 5.2. **Test equipment**
- 5.2.1. *Chassis dynamometer*
- 5.2.1.1. When the durability test is performed on a chassis dynamometer, the dynamometer must enable the cycle described in 5.1 to be carried out. In particular, it must be equipped with systems simulating inertia and resistance to progress.
- 5.2.1.2. The brake must be adjusted in order to absorb the power exerted on the driving wheels at a steady speed of 80 km/h. Methods to be applied to determine this power and to adjust the brake are the same as those described in Appendix 3 to Annex III.
- 5.2.1.3. The vehicle cooling system should enable the vehicle to operate at temperatures similar to those obtained on road (oil, water, exhaust system, etc.).
- 5.2.1.4. Certain other test bench adjustments and features are deemed to be identical, where necessary, to those described in Annex III of this Directive (inertia, for example, which may be mechanical or electronic).
- 5.2.1.5. The vehicle may be moved, where necessary, to a different bench in order to conduct emission measurement tests.
- 5.2.2. *Operation on track or road*
- When the durability test is completed on track or road, the vehicle's reference mass will be at least equal to that retained for tests conducted on a chassis dynamometer.
6. MEASURING EMISSIONS OF POLLUTANTS

▼ M15

At the start of the test (0 km), and every 10 000 km (\pm 400 km) or more frequently, at regular intervals until having covered 80 000 km, tailpipe emissions are measured in accordance with the type I test as defined in section 5.3.1 of Annex I. The limit values to be complied with are those laid down in section 5.3.1.4 of Annex I.

▼ M9

All exhaust emissions results must be plotted as a function of the running distance on the system rounded to the nearest kilometre and the best fit straight line fitted by the method of least squares shall be drawn through all these data points. This calculation shall not take into account the test results at 0 km.

The data will be acceptable for use in the calculation of the deterioration factor only if the interpolated 6 400 km and 80 000 km points on this line are within the above mentioned limits. The data are still acceptable when a best fit straight line crosses an applicable limit with a negative slope (the 6 400 km interpolated point is higher than the 80 000 km interpolated point) but the 80 000 km actual data point is below the limit.

A multiplicative exhaust emission deterioration factor shall be calculated for each pollutant as follows:

$$\text{D.E.F.} = \frac{M_{i2}}{M_{i1}}$$

where:

M_{i1} = mass emission of the pollutant i in grams per km interpolated to 6 400 km,

M_{i2} = mass emission of the pollutant i in grams per km interpolated to 80 000 km.

▼ M9

These interpolated values must be carried out to a minimum of four places to the right of the decimal point before dividing one by the other to determine the deterioration factor. The result must be rounded to three places to the right of the decimal point.

If a deterioration factor is less than one, it is deemed to be equal to one.

SPECIFICATIONS OF REFERENCE FUELS

1. TECHNICAL DATA OF THE REFERENCE FUEL TO BE USED FOR TESTING VEHICLES EQUIPPED WITH POSITIVE-IGNITION ENGINES

Type: Unleaded petrol

| Parameter | Unit | Limits ⁽¹⁾ | | Test Method | Publica- tion |
|------------------------------------|-------------------|-----------------------|---------|--------------------------|-----------------------|
| | | Minimum | Maximum | | |
| Research octane number, RON | | 95,0 | — | EN 25164 | 1993 |
| Motor octane number, MON | | 85,0 | — | EN 25163 | 1993 |
| Density at 15 °C | kg/m ³ | 748 | 762 | ISO 3675 | 1995 |
| Reid vapour pressure | kPa | 56,0 | 60,0 | EN 12 | 1993 |
| Distillation: | | | | | |
| — initial boiling point | °C | 24 | 40 | EN-ISO 3405 | 1988 |
| — evaporated at 100 °C | % v/v | 49,0 | 57,0 | EN-ISO 3405 | 1988 |
| — evaporated at 150 °C | % v/v | 81,0 | 87,0 | EN-ISO 3405 | 1988 |
| — final boiling point | °C | 190 | 215 | EN-ISO 3405 | 1998 |
| Residue | % | — | 2 | EN-ISO 3405 | 1998 |
| Hydrocarbon analysis: | | | | | |
| — olefins | % v/v | — | 10 | ASTM D 1319 | 1995 |
| — aromatics ⁽²⁾ | % v/v | 28,0 | 40,0 | ASTM D 1319 | 1995 |
| — benzene | % v/v | — | 1,0 | pr. EN 12177 | [1998] ⁽²⁾ |
| — saturates | % v/v | — | balance | ASTM D 1319 | 1995 |
| Carbon/hydrogen ratio | | report | report | | |
| Oxidation stability ⁽⁴⁾ | min. | 480 | — | EN-ISO 7536 | 1996 |
| Oxygen content ⁽⁵⁾ | % m/m | — | 2,3 | EN 1601 | [1997] ⁽²⁾ |
| Existent gum | mg/ml | — | 0,04 | EN-ISO 6246 | [1997] ⁽²⁾ |
| Sulphur content ⁽⁶⁾ | mg/kg | — | 100 | pr. EN-ISO/ DIS 14596 | [1998] ⁽²⁾ |
| Copper corrosion at 50 °C | | — | 1 | EN-ISO 2160 | 1995 |
| Lead content | g/l | — | 0,005 | EN 237 | 1996 |
| Phosphorus content | g/l | — | 0,0013 | ASTM D 3231 | 1994 |

⁽¹⁾ The values quoted in the specification are 'true values'. In establishment of their limit values the terms of ISO 4259 'Petroleum products — Determination and application of precision data in relation to methods of test' have been applied and in fixing a minimum value, a minimum difference of 2R above zero has been taken into account; in fixing a maximum and minimum value, the minimum difference is 4R (R = reproducibility).

Notwithstanding this measure, which is necessary for statistical reasons, the manufacturer of fuels should nevertheless aim at a zero value where the stipulated maximum value is 2R and at the mean value in the case of quotations of maximum and minimum limits. Should it be necessary to clarify the question as to whether a fuel meets the requirements of the specifications, the terms of ISO 4259 should be applied.

⁽²⁾ The month of publication will be completed in due course.

⁽³⁾ The reference fuel used to approve a vehicle against the limit values set out in row B of the table in section 5.3.1.4 of Annex I to this Directive shall have a maximum aromatics content of 35 % v/v. The Commission will as soon as possible, but no later than 31 December 1999, bring forward a modification to this Annex reflecting the market average for fuel aromatics content in respect of the fuel defined in Annex III of Directive 98/70/EC.

⁽⁴⁾ The fuel may contain oxidation inhibitors and metal deactivators normally used to stabilise refinery gasoline streams, but detergent/dispersive additives and solvent oils must not be added.

⁽⁵⁾ The actual oxygen content of the fuel for the Type I and IV tests shall be reported. In addition the maximum oxygen content of the reference fuel used to approve a vehicle against the limit values set out in row B of the table in section 5.1.3.4 of the Annex I to this Directive shall be 2,3 %. The Commission will as soon as possible, but no later than 31 December 1999, bring forward a modification to this Annex reflecting the market average for fuel oxygen content of the fuel defined in Annex III of Directive 98/70/EC.

⁽⁶⁾ The actual sulphur content of the fuel used for the Type I test shall be reported. In addition the reference fuel used to approve a vehicle against the limit values set out in row B of the table in section 5.1.3.4 of Annex I to this Directive shall have a maximum sulphur content of 50 ppm. The Commission will as soon

▼ M15

as possible, but no later than 31 December 1999, bring forward a modification to this Annex reflecting the market average for fuel sulphur content in respect of the fuel defined in Annex III of Directive 98/70/EC.

▼ **M15**

2. TECHNICAL DATA OF THE REFERENCE FUEL TO BE USED FOR TESTING VEHICLES EQUIPPED WITH A DIESEL ENGINE

Type: Diesel fuel

| Parameter | Unit | Limits ⁽¹⁾ | | Test Method | Publication |
|--|--------------------|-----------------------|-------|--------------------------|-----------------------|
| | | Min | Max | | |
| Cetane number ⁽²⁾ | | 52,0 | 54,0 | EN-ISO 5165 | 1998 ⁽³⁾ |
| Density at 15 °C | kg/m ³ | 833 | 837 | EN-ISO 3675 | 1995 |
| Distillation | | | | | |
| — 50 % point | °C | 245 | — | EN-ISO 3405 | 1988 |
| — 95 % point | °C | 345 | 350 | EN-ISO 3405 | 1988 |
| — final boiling point | °C | — | 370 | EN-ISO 3405 | 1988 |
| Flash point | °C | 55 | — | EN 22719 | 1993 |
| CFPP | °C | — | -5 | EN 116 | 1981 |
| Viscosity at 40 °C | mm ² /s | 2,5 | 3,5 | EN-ISO 3104 | 1996 |
| Polycyclic aromatic hydrocarbons | % m/m | 3 | 6,0 | IP 391 | 1995 |
| Sulphur content ⁽⁴⁾ | mg/kg | — | 300 | pr. EN-ISO/ DIS 14596 | 1998 ⁽³⁾ |
| Copper corrosion | | — | 1 | EN-ISO 2160 | 1995 |
| Conradson carbon residue (10 % DR) | % m/m | — | 0,2 | EN-ISO 10370 | 1995 |
| Ash content | % m/m | — | 0,01 | EN-ISO 6245 | 1995 |
| Water content | % m/m | — | 0,05 | EN-ISO 12937 | [1998] ⁽³⁾ |
| Neutralisation (strong acid) number | mg KOH/g | — | 0,02 | ASTM D 974-95 | 1998 ⁽³⁾ |
| Oxidation stability ⁽⁵⁾ | mg/ml | — | 0,025 | EN-ISO 12205 | 1996 |
| New and better method for polycyclic aromatics under development | % m/m | — | — | EN 12916 | [1997] ⁽³⁾ |

(1) The values quoted in the specification are 'true values'. In establishment of their limit values the terms of ISO 4259 'Petroleum products — Determination and application of precision data in relation to methods of test' have been applied and in fixing a minimum value, a minimum difference of 2R above zero has been taken into account; in fixing a maximum and minimum value, the minimum difference is 4R (R = reproducibility).

Notwithstanding this measure, which is necessary for statistical reasons, the manufacturer of fuels should nevertheless aim at a zero value where the stipulated maximum value is 2R and at the mean value in the case of quotations of maximum and minimum limits. Should it be necessary to clarify the question as to whether a fuel meets the requirements of the specifications, the terms of ISO 4259 should be applied.

(2) The range for cetane number is not in accordance with the requirement of a minimum range of 4R. However, in the case of a dispute between fuel supplier and fuel user, the terms in ISO 4259 may be used to resolve such disputes provided replicate measurements, of sufficient number to archive the necessary precision, are made in preference to single determinations.

(3) The month of publication will be completed in due course.

(4) The actual sulphur content of the fuel used for the Type I test shall be reported. In addition the reference fuel used to approve a vehicle against the limit values set out in row B of the table in section 5.1.3.4 of Annex I to this Directive shall have a maximum sulphur content of 50 ppm. The Commission will as soon as possible, but no later than 31 December 1999, bring forward a modification to this Annex reflecting the market average for fuel sulphur content in respect of the fuel defined in Annex III of Directive 98/70/EC.

(5) Even though oxidation stability is controlled, it is likely that shelf life will be limited. Advice should be sought from the supplier as to storage conditions and life.

▼ M15

► C4 3. TECHNICAL DATA ◀ OF THE REFERENCE FUEL TO BE USED FOR TESTING VEHICLES EQUIPPED WITH POSITIVE-IGNITION ENGINES AT LOW AMBIENT TEMPERATURE TYPE VI TEST (1)

Type: **Unleaded premium petrol**

| Parameter | Unit | Limits (2) | | Test Method | Publica- tion |
|-----------------------------|-------------------|------------|---------|--------------------------|------------------|
| | | Min | Max | | |
| Research octane number, RON | | 95,0 | — | EN 25164 | 1993 |
| Motor octane number, MON | | 85,0 | — | EN 25163 | 1993 |
| Density at 15 °C | kg/m ³ | 748 | 775 | ISO 3675 | 1995 |
| Reid vapour pressure | kPa | 56,0 | 95,0 | EN 12 | 1993 |
| Distillation | | | | | |
| — initial boiling point | °C | 24 | 40 | EN-ISO 3405 | 1988 |
| — evaporated at 100 °C | % v/v | 49,0 | 57,0 | EN-ISO 3405 | 1988 |
| — evaporated at 150 °C | % v/v | 81,0 | 87,0 | EN-ISO 3405 | 1988 |
| — final boiling point | °C | 190 | 215 | EN-ISO 3405 | 1988 |
| Residue | % | — | 2 | EN-ISO 3405 | |
| Hydrocarbon analysis: | | | | | |
| — olefins | % v/v | — | 10 | ASTM D 1319 | 1995 |
| — aromatics (4) | % v/v | 28,0 | 40,0 | ASTM D 1319 | 1995 |
| — benzene | % v/v | — | 1,0 | pr. EN 12177 | [1998] (3) |
| — saturates | | — | balance | ASTM D 1319 | 1995 |
| Carbon/hydrogen ratio | | report | report | | |
| Oxidation stability (5) | mn. | 480 | — | EN-ISO 7536 | 1996 |
| Oxygen content (6) | % m/m | — | 2,3 | EN 1601 | [1997] (3) |
| Existent gum | mg/ml | — | 0,04 | EN-ISO 6246 | [1997] (3) |
| Sulphur content (7) | mg/kg | — | 100 | pr. EN-ISO/ DIS 14596 | [1998] (3) |
| Copper corrosion at 50 °C | | — | 1 | EN-ISO 2160 | 1995 |
| Lead content | g/l | — | 0,005 | EN 237 | 1996 |
| Phosphorous content | g/l | — | 0,0013 | ASTM D 3231 | 1994 |

(1) Petrol having the specification in the above table must be used in low ambient temperature Type VI testing, if the manufacturer does not specifically choose the fuel in section 1 of this Annex in accordance with section 3.4 of Annex VII.

(2) The values quoted in the specification are 'true values'. In establishment of their limit values the terms of ISO 4259 'Petroleum products — Determination and application of precision data in relation to methods of test' have been applied and in fixing a minimum value, a minimum difference of 2R above zero has been taken into account; in fixing a maximum and minimum value, the minimum difference is 4R (R = reproducibility).

Notwithstanding this measure, which is necessary for statistical reasons, the manufacturer of fuels should nevertheless aim at a zero value where the stipulated maximum value is 2R and at the mean value in the case of quotations of maximum and minimum limits. Should it be necessary to clarify the question as to whether a fuel meets the requirements of the specifications, the terms of ISO 4259 should be applied.

(3) The month of publication will be completed in due course.

(4) The reference fuel used to approve a vehicle against the limit values set out in row B of the table in section 5.3.1.4 of Annex I to this Directive shall have a maximum aromatics content of 35 % v/v. The Commission will as soon as possible, but no later than 31 December 1999, bring forward a modification to this Annex reflecting the market average for fuel aromatics content in respect of the fuel defined in Annex III of Directive 98/70/EC.

(5) The fuel may contain oxidation inhibitors and metal deactivators normally used to stabilise refinery gasoline streams, but detergent/dispersive additives and solvent oils must not be added.

(6) The actual oxygen content of the ► C4 fuel used for the Type VI test ◀ shall be reported. In addition the maximum oxygen content of the reference fuel used to approve a vehicle against the limit values set out in row B of the table in section 5.1.3.4 of Annex I to this Directive shall be 2,3 %. The Commission will as soon as possible, but no later than 31 December 1999, bring forward a modification to this Annex reflecting the market average for fuel oxygen content in respect of the fuel defined in Annex III of Directive 98/70/EC.

(7) The actual sulphur content of the ► C4 fuel used for the Type VI test ◀ shall be reported. In addition the reference fuel used to approve a vehicle against the limit values set out in row B of the table in section 5.1.3.4 of Annex I to this Directive shall have a maximum sulphur content of 50 ppm. The Commission will as soon as possible, but no later than 31 December 1999, bring forward a modification to this Annex

▼ M15

reflecting the market average for fuel sulphur content in respect of the fuel defined in Annex III of Directive 98/70/EC.

▼ **M12**ANNEX ► **M15** X ◀**MODEL**

(Maximum format: A4 (210 × 297 mm))

EEC TYPE-APPROVAL CERTIFICATE

| |
|----------------------------|
| Stamp of administration |
|----------------------------|

Communication concerning the

- type-approval ⁽¹⁾,
- extension of type-approval ⁽¹⁾,
- refusal of type-approval ⁽¹⁾,
- withdrawal of type-approval ⁽¹⁾,

of a type of a vehicle / component / separate technical unit ⁽¹⁾ with regard to Directive .../.../EC, as last amended by Directive .../.../EC.

Type-approval number:

Reason for extension:

SECTION I

- 0.1. Make (trade name of manufacturer):
- 0.2. Type and general commercial description(s):
- 0.3. Means of identification of type if marked on the vehicle / component / separate technical unit ⁽¹⁾ ⁽²⁾: ...
- 0.3.1. Location of that marking:
- 0.4. Category of vehicle ⁽³⁾:
- 0.5. Name and address of manufacturer:
- 0.7. In the case of components and separate technical units, location and method of affixing of the EEC approval mark:
- 0.8. Address(es) of assembly plant(s):

SECTION II

1. Additional information (where applicable): See Addendum
2. Technical service responsible for carrying out the tests:
3. Date of test report:
4. Number of test report:
5. Remarks (if any): See Addendum
6. Place:
7. Date:
8. Signature:
9. The index to the information package lodged with the approval authority, which may be obtained on request, is attached.

⁽¹⁾ Delete where not applicable.⁽²⁾ If the means of identification of type contains characters not relevant to describe the vehicle, component or separate technical unit types covered by this type-approval certificate such characters shall be represented in the document by the symbol: “?” (e.g. ABC??123??).⁽³⁾ As defined in Annex II A to Directive 70/156/EEC.

▼ **M12**

Appendix

Addendum to EEC type-approval certificate No ...

concerning the type-approval of a vehicle with regard to Directive 70/220/EEC, as last amended by Directive .../.../EC

- 1. Additional information
- 1.1. Mass of the vehicle in running order:
- 1.2. Maximum mass:
- 1.3. Reference mass:
- 1.4. Number of seats:
- 1.5. Engine identification:
- 1.6. Gearbox
- 1.6.1. Manual, number of speeds (!):
- 1.6.2. Automatic, number of ratios (!):
- 1.6.3. Continuously variable: yes/no (!)
- 1.6.4. Ratio of the individual gears:
- 1.6.5. Ratio of final drive:
- 1.7. Range of tyre sizes:
- 1.7.1. Rolling circumference of tyres used for the Tyre I :
- ▶⁽¹⁾1.8. Test results:

| Type I | CO (g/km) | HC ⁽¹⁾ | NO _x ▶ ⁽¹⁾ ◀ | HC + NO _x (g/km) ▶ ⁽¹⁾ (²)◀ | Particulates ⁽²⁾ (g/km) |
|----------|-----------|-------------------|------------------------------------|--|------------------------------------|
| measured | | | | | |
| | | | | | |
| | | | | | |
| with DF | | | | | |
| | | | | | |
| | | | | | |

- Type II: %
- Type III:
- Type IV: g/test
- Type V: — Durability type: 80 000 km, not applicable ⁽¹⁾
 — Deterioration factor DF: calculated, fixed ⁽¹⁾
 — Specify the values:

| Type VI | CO (g/km) | HC (g/km) |
|----------------|-----------|-----------|
| Measured value | | |

- 1.8.1. Written description and/or drawing of the MI:

- 1.8.2. List and function of all components monitored by the OBD system:

▼ **M12**

- ▶⁽⁹⁾ 1.8.3. Descripción de los principios generales de funcionamiento de:
.....
- 1.8.3.1. Detección de fallos de encendido ⁽⁴⁾:
.....
- 1.8.3.2. Vigilancia del catalizador ⁽⁴⁾:
.....
- 1.8.3.3. Vigilancia del sensor de oxígeno ⁽⁴⁾:
.....
- 1.8.3.4. Otros componentes vigilados por el sistema de DAB ⁽⁴⁾:
.....
- 1.8.3.5. Vigilancia del catalizador ⁽⁵⁾:
.....
- 1.8.3.6. Vigilancia del purgador de partículas ⁽⁵⁾:
.....
- 1.8.3.7. Vigilancia del sistema electrónico de alimentación del combustible ⁽⁵⁾:
.....
- 1.8.3.8. Otros componentes vigilados por el sistema de DAB ⁽⁵⁾:
.....
- 1.8.4. Criterios de activación del IMF (número fijo de ciclos de conducción o método estadístico):
.....
- 1.8.5. Códigos de salida de DAB y formatos utilizados con las explicaciones correspondientes:
..... ◀

▶⁽⁹⁾ 1.9. Datos de emisiones exigidos en la prueba de aptitud para la circulación

| Prueba | Valor CO (% vol) | Lambda ⁽¹⁾ | Velocidad del motor (min ⁻¹) | Temperatura de aceite del motor (°C) |
|---------------------|---------------------|-----------------------|---|--|
| Prueba ralenti bajo | | N/A | | |
| Prueba ralenti alto | | | | |

⁽¹⁾ Fórmula Lambda: véase la nota 1 del punto 5.3.7.3. del anexo I. ◀

5. Remarks:

⁽¹⁾ Táchese lo que no proceda.
⁽²⁾ Para los motores de explosión.
⁽³⁾ Para los motores de combustión interna.
⁽⁴⁾ En el caso de los motores de explosión.
⁽⁵⁾ En el caso de los motores de combustión interna.

ON-BOARD DIAGNOSTICS (OBD) FOR MOTOR VEHICLES

1. INTRODUCTION

This Annex applies to the functional aspects of on-board diagnostic (OBD) system for the emission control of motor vehicles.

2. DEFINITIONS

For the purposes of this Annex:

- 2.1. 'OBD' means an on-board diagnostic system for emission control which must have the capability of identifying the likely area of malfunction by means of fault codes stored in computer memory.
- 2.2. 'Vehicle type' means a category of power-driven vehicles which do not differ in such essential engine and OBD system characteristics as defined in Appendix 2.
- 2.3. 'Vehicle family' means a manufacturer's grouping of vehicles which, through their design, are expected to have similar exhaust emission and OBD system characteristics. Each engine of this family must have complied with the requirements of this Directive.
- 2.4. 'Emission control system' means the electronic engine management controller and any emission-related component in the exhaust or evaporative system which supplies an input to or receives an output from this controller.
- 2.5. 'Malfunction indicator (MI)' means a visible or audible indicator that clearly informs the driver of the vehicle in the event of a malfunction of any emission-related component connected to the OBD system, or the OBD system itself.
- 2.6. 'Malfunction' means the failure of an emission-related component or system that would result in emissions exceeding the limits in section 3.3.2.
- 2.7. 'Secondary air' refers to air introduced into the exhaust system by means of a pump or aspirator valve or other means that is intended to aid in the oxidation of HC and CO contained in the exhaust gas stream.
- 2.8. 'Engine misfire' means lack of combustion in the cylinder of a positive-ignition engine due to absence of spark, poor fuel metering, poor compression or any other cause. In terms of OBD monitoring it is that percentage of misfires out of a total number of firing events (as declared by the manufacturer) that would result in emissions exceeding the limits given in section 3.3.2 or that percentage that could lead to an exhaust catalyst, or catalysts, overheating causing irreversible damage.
- 2.9. 'Type I test' means the driving cycle (Parts One and Two) used for emission approvals, as detailed in Annex III, Appendix 1.
- 2.10. 'A driving cycle' consists of engine start-up, driving mode where a malfunction would be detected if present, and engine shut-off.
- 2.11. 'A warm-up cycle' means sufficient vehicle operation such that the coolant temperature has risen by at least 22 °K from engine starting and reaches a minimum temperature of 343 °K (70 °C).
- 2.12. 'Fuel trim' refers to feedback adjustments to the base fuel schedule. Short-term fuel trim refers to dynamic or instantaneous adjustments. Long-term fuel trim refers to much more gradual adjustments to the fuel calibration schedule than short-term trim adjustments. These long-term adjustments compensate for vehicle differences and gradual changes that occur over time.
- 2.13. 'Calculated load value' refers to an indication of the current airflow divided by peak airflow, where peak airflow is corrected for altitude, if available. This definition provides a dimensionless number that is not engine specific and provides the service technician with an indication of the proportion of engine capacity that is being used (with wide open throttle as 100 %);

$$CLV = \frac{\text{Current airflow}}{\text{Peak airflow (at sea level)}} \times \frac{\text{Atmospheric pressure (at sea level)}}{\text{Barometric pressure}}$$

▼ M15

- 2.14. 'Permanent emission default mode' refers to a case where the engine management controller permanently switches to a setting that does not require an input from a failed component or system where such a failed component or system would result in an increase in emissions from the vehicle to a level above the limits given in section 3.3.2.
- 2.15. 'Power take-off unit' means an engine-driven output provision for the purposes of powering auxiliary, vehicle mounted, equipment.
- 2.16. 'Access' means the availability of all emission-related OBD data including all fault codes required for the inspection, diagnosis, servicing or repair of emissions-related parts of the vehicle, via the serial interface for the standard diagnostic connection (pursuant to Appendix 1, section 6.5.3.5 of this Annex).
- 2.17. 'Unrestricted' means
- access not dependent on an access code obtainable only from the manufacturer, or a similar device, or
 - access allowing evaluation of the data produced without the need for any unique decoding information, unless that information itself is standardised.
- 2.18. 'Standardised' means that all data stream information, including all fault codes used, shall be produced only in accordance with industry standards which, by virtue of the fact that their format and their permitted options are clearly defined, provide for a maximum level of harmonisation in the motor vehicle industry, and whose use is expressly permitted in this Directive.

▼ C4

- 2.19. 'Repair information' means all information required for diagnosis, servicing, inspection, periodic monitoring or repair of the vehicle and which the manufacturers provide for their authorised dealers/repair shops. Where necessary, such information shall include service handbooks, technical manuals, diagnosis information (e.g. minimum and maximum theoretical values for measurements), wiring diagrams, the software calibration identification number applicable to a vehicle type, instructions for individual and special cases, information provided concerning tools and equipment, data record information and two-directional monitoring and test data. The manufacturer shall not be obliged to make available that information which is covered by intellectual property rights or constitutes specific know-how of manufacturers and/or OEM suppliers; in this case the necessary technical information shall not be improperly withheld.

▼ M15

3. REQUIREMENTS AND TESTS
- 3.1. All vehicles must be equipped with an OBD system so designed, constructed and installed in a vehicle as to enable it to identify types of deterioration or malfunction over the entire life of the vehicle. In achieving this objective the approval authority must accept that vehicles which have travelled distances in excess of the Type V durability distance, referred to in 3.3.1, may show some deterioration in OBD system performance such that the emission limits given in 3.3.2 may be exceeded before the OBD system signals a failure to the driver of the vehicle.
- 3.1.1 Access to the OBD system required for the inspection, diagnosis, servicing or repair of the vehicle must be unrestricted and standardised. All emission-related fault codes must be consistent with ISO DIS 15031-6 (SAE J 2012, dated July 1996).
- 3.1.2. No later than three months after the manufacturer has provided any authorised dealer or repair shop within the Community with repair information, the manufacturer shall make that information (including all subsequent amendments and supplements) available upon reasonable and non-discriminatory payment and shall notify the approval authority accordingly.
- In the event of failure to comply with these provisions the approval authority shall take appropriate measures to ensure that repair information is available, in accordance with the procedures laid down for type-approval and in-service surveys.
- 3.2. The OBD system must be so designed, constructed and installed in a vehicle as to enable it to comply with the requirements of this Annex during conditions of normal use.

▼ **M15**3.2.1. *Temporary disablement of the OBD system*

3.2.1.1. A manufacturer may disable the OBD system if its ability to monitor is affected by low fuel levels. Disablement must not occur when the fuel tank level is above 20 % of the nominal capacity of the fuel tank.

3.2.1.2. A manufacturer may disable the OBD system at ambient engine starting temperatures below 266 °K (−7 °C) or at elevations over 2 500 metres above sea level provided the manufacturer submits data and/or an engineering evaluation which adequately demonstrate that monitoring would be unreliable when such conditions exist. A manufacturer may also request disablement of the OBD system at other ambient engine starting temperatures if he demonstrates to the authority with data and/or an engineering evaluation that misdiagnosis would occur under such conditions.

3.2.1.3. For vehicles designed to accommodate the installation of power take-off units, disablement of affected monitoring systems is permitted provided disablement occurs only when the power take-off unit is active.

3.2.2. *Engine misfire — vehicles equipped with positive-ignition engines*

3.2.2.1. Manufacturers may adopt higher misfire percentage malfunction criteria than those declared to the authority, under specific engine speed and load conditions where it can be demonstrated to the authority that the detection of lower levels of misfire would be unreliable.

3.2.2.2. Manufacturers who can demonstrate to the authority that the detection of higher levels of misfire percentages is still not feasible may disable the misfire monitoring system when such conditions exist.

3.3. **Description of tests**

3.3.1. The test are carried out on the vehicle used for the Type V durability test, given in Annex VIII, and using the test procedure in Appendix I to this Annex. Tests are carried out at the conclusion of the Type V durability testing. When no Type V durability testing is carried out, or at the request of the manufacturer, a suitably aged and representative vehicle may be used for these OBD demonstration tests.

3.3.2. The OBD system must indicate the failure of an emission-related component or system when that failure results in an increase in emissions above the limits given below:

| | | Reference mass | Mass of carbon monoxide | | Mass of hydrocarbons | | Mass of oxides of nitrogen | | Mass of particulates ⁽¹⁾ |
|--|-------|------------------|-------------------------|--------|----------------------|--------|------------------------------------|--------|-------------------------------------|
| | | (RW) (kg) | (CO) L1 (g/km) | | (HC) L2 (g/km) | | (NO _x) L3 (g/km) | | (PM) L4 (g/km) |
| Category | Class | | Petrol | Diesel | Petrol | Diesel | Petrol | Diesel | Diesel |
| M ⁽²⁾ | — | all | 3,2 | 3,2 | 0,4 | 0,4 | 0,6 | 1,2 | 0,18 |
| N ₁ ⁽³⁾ ⁽⁴⁾ | I | RW ≤ 1305 | 3,2 | 3,2 | 0,4 | 0,4 | 0,6 | 1,2 | 0,18 |
| | II | 1305 < RW ≤ 1760 | 5,8 | 4,0 | 0,5 | 0,5 | 0,7 | 1,6 | 0,23 |
| | III | 1760 < RW | 7,3 | 4,8 | 0,6 | 0,6 | 0,8 | 1,9 | 0,28 |

⁽¹⁾ For compression ignition engines.

⁽²⁾ Except vehicles the maximum mass of which exceeds 2 500 kg.

⁽³⁾ And those Category M vehicles which are specified in note 2.

⁽⁴⁾ The Commission proposal referred to in Article 3(1) of this Directive shall contain the threshold limit values for OBD for 2005/6 for M₁ and N₁ vehicles.

3.3.3. *Monitoring requirements for vehicles equipped with positive-ignition engines*

In satisfying the requirements of 3.3.2 the OBD system must, at a minimum, monitor for:

3.3.3.1. reduction in the efficiency of the catalytic converter with respect to the emissions of HC only;

▼ **M15**

- 3.3.3.2. the presence of engine misfire in the engine operating region bounded by the following lines:
- a maximum speed of $4\,500\text{min}^{-1}$ or $1\,000\text{min}^{-1}$ greater than the highest speed occurring during a Type I test cycle, whichever is the lower;
 - the positive torque line (i. e. engine load with the transmission in neutral);
 - a line joining the following engine operating points: the positive torque line at $3\,000\text{min}^{-1}$ and a point on the maximum speed line defined in (a) above with the engine's manifold vacuum at 13,33 kPa lower than that at the positive torque line.
- 3.3.3.3. oxygen sensor deterioration
- 3.3.3.4. other emission control system components or systems, or emission-related powertrain components or systems which are connected to a computer, the failure of which may result in tailpipe emissions exceeding the limits given in 3.3.2;
- 3.3.3.5. any other emission-related powertrain component connected to a computer must be monitored for circuit continuity;
- 3.3.3.6. the electronic evaporative emission purge control must, at a minimum, be monitored for circuit continuity.
- 3.3.4. *Monitoring requirements for vehicles equipped with compression-ignition engines*
- In satisfying the requirements of 3.3.2 the OBD system must monitor:
- Where fitted, reduction in the efficiency of the catalytic converter;
 - Where fitted, the functionality and integrity of the particulate trap;
 - The fuel-injection system electronic fuel quantity and timing actuator(s) is/are monitored for circuit continuity and total functional failure;
 - Other emission control system components or systems, or emission-related powertrain components or systems, which are connected to a computer, the failure of which may result in tailpipe emissions exceeding the limits given in 3.3.2. Examples of such systems or components are those for monitoring and control of air mass-flow, air volumetric flow (and temperature), boost pressure and inlet manifold pressure (and relevant sensors to enable these functions to be carried out).
 - Any other emission-related powertrain component connected to a computer must be monitored for circuit continuity.
- 3.3.5. Manufacturers may demonstrate to the approval authority that certain components or systems need not be monitored if, in the event of their total failure or removal, emissions do not exceed the emission limits given in 3.3.2.
- 3.4. A sequence of diagnostic checks must be initiated at each engine start and completed at least once provided that the correct test conditions are met. The test conditions must be selected in such a way that they all occur under normal driving as represented by the Type I test.
- 3.5. **Activation of malfunction indicator (MI)**
- The OBD system must incorporate a malfunction indicator readily perceivable to the vehicle operator. The MI must not be used for any other purpose except to indicate emergency start-up or limp-home routines to the driver. The MI must be visible in all reasonable lighting conditions. When activated, it must display a symbol in conformity with ISO 2575⁽¹⁾. A vehicle must not be equipped with more than one general purpose MI for emission-related problems. Separate specific purpose telltales (e. g. brake system, fasten seat belt, oil pressure, etc.) are permitted. The use of red for an MI is prohibited.
 - For strategies requiring more than two preconditioning cycles for MI activation, the manufacturer must provide data and/or an engineering evaluation which adequately demonstrates that the monitoring system is equally effective and timely in detecting component deterioration. Strategies requiring on average more than 10 driving cycles for MI acti-

(1) International Standard ISO 2575-1982 (E), entitled 'Road vehicles — Symbols for controls indicators and tell-tales', Symbol Number 4.36.

▼ **M15**

vation are not accepted. The MI must also activate whenever the engine control enters a permanent emission default mode of operation if the emission limits given in 3.3.2 are exceeded. The MI must operate in a distinct warning mode, e. g. a flashing light, under any period during which engine misfire occurs at a level likely to cause catalyst damage, as specified by the manufacturer. The MI must also activate when the vehicle's ignition is in the 'key-on' position before engine starting or cranking and de-activate after engine starting if no malfunction has previously been detected.

3.6. **Fault code storage**

The OBD system must record code(s) indicating the status of the emission-control system. Separate status codes must be used to identify correctly functioning emission control systems and those emission control systems which need further vehicle operation to be fully evaluated. Fault codes that cause MI activation due to deterioration or malfunction or permanent emission default modes of operation must be stored and that fault code must identify the type of malfunction.

- 3.6.1. The distance travelled by the vehicle since the MI was activated must be available at any instant through the serial port on the standard link connector⁽¹⁾.
- 3.6.2. In the case of vehicles equipped with positive-ignition engines, misfiring cylinders need not be uniquely identified if a distinct single or multiple cylinder misfire fault code is stored.

3.7. **Extinguishing the MI**

- 3.7.1. For misfire malfunctions at levels likely to cause catalyst damage (as specified by the manufacturer), the MI may be switched to the normal mode of activation if the misfire is not present any more, or if the engine is operated after changes to speed and load conditions where the level of misfire will not cause catalyst damage.
- 3.7.2. For all other malfunctions, the MI may be de-activated after three subsequent sequential driving cycles during which the monitoring system responsible for activating the MI ceases to detect the malfunction and if no other malfunction has been identified that would independently activate the MI.

3.8. **Erasing a fault code**

- 3.8.1. The OBD system may erase a fault code and the distance travelled and freeze-frame information if the same fault is not re-registered in at least 40 engine warm-up cycles.

⁽¹⁾ This requirement is only applicable to vehicles with an electronic speed input to the engine management provided the ISO standards are completed within a lead time compatible with the application of the technology. It applies to all vehicles entering into service from 1 January 2005.

▼ **M15***Appendix 1***FUNCTIONAL ASPECTS OF ON-BOARD DIAGNOSTIC (OBD) SYSTEMS**

1. INTRODUCTION

This Appendix describes the procedure of the test according to section 5 of this Annex. The procedure describes a method for checking the function of the on-board diagnostic (OBD) system installed on the vehicle by failure simulation of relevant systems in the engine management or emission control system. It also sets procedures for determining the durability of OBD systems.

The manufacturer must make available the defective components and/or electrical devices which would be used to simulate failures. When measured over the Type I test cycle, such defective components or devices must not cause the vehicle emissions to exceed the limits of section 3.3.2 by more than 20 %.

When the vehicle is tested with the defective component or device fitted, the OBD system is approved if the MI is activated.

2. DESCRIPTION OF TEST

2.1. The testing of OBD systems consists of the following phases:

- simulation of malfunction of a component of the engine management or emission control system,
- preconditioning of the vehicle with a simulated malfunction over preconditioning specified ► **C3** in section 6.2 ◀,
- driving the vehicle with a simulated malfunction over the Type I test cycle and measuring the emissions of the vehicle,
- determining whether the OBD system reacts to the simulated malfunction and indicates malfunction in an appropriate manner to the vehicle driver.

2.2. Alternatively, at the request of the manufacturer, malfunction of one or more components may be electronically simulated according to the requirements of section 6.

2.3. Manufacturers may request that monitoring take place outside the Type I test cycle if it can be demonstrated to the authority that monitoring during conditions encountered during the Type I test cycle would impose restrictive monitoring conditions when the vehicle is used in service.

3. TEST VEHICLE AND FUEL

3.1. **Vehicle**

The test vehicle must meet the requirements of section 3.1 of Annex III.

3.2. **Fuel**

The appropriate reference fuel as described in Annex IX must be used for testing.

4. TEST TEMPERATURE AND PRESSURE

4.1. The test temperature and pressure must meet the requirements of the Type I test as described in Annex III.

5. TEST EQUIPMENT

5.1. **Chassis dynamometer**

The chassis dynamometer must meet the requirements of Annex III.

6. OBD TEST PROCEDURE

6.1. The operating cycle on the chassis dynamometer must meet the requirements of Annex III.

▼ **M15****6.2. Vehicle preconditioning**

- 6.2.1. According to the engine type and after introduction of one of the failure modes given in 6.3, the vehicle must be preconditioned by driving at least two consecutive Type I tests (Parts One and Two). For compression-ignition engines an additional preconditioning of two Part Two cycles is permitted.
- 6.2.2. At the request of the manufacturer, alternative preconditioning methods may be used.

6.3. Failure modes to be tested*6.3.1. Positive-ignition engines:*

- 6.3.1.1. Replacement of the catalyst with a deteriorated or defective catalyst or electronic simulation of such a failure.
- 6.3.1.2. Engine misfire conditions according to the conditions for misfire monitoring given in section 3.3.3.2 of this Annex.
- 6.3.1.3. Replacement of the oxygen sensor with a deteriorated or defective oxygen sensor or electronic simulation of such a failure.
- 6.3.1.4. Electrical disconnection of any other emission-related component connected to a powertrain management computer.
- 6.3.1.5. Electrical disconnection of the electronic evaporative purge control device (if equipped). For this specific failure mode, the Type I test must not be performed.

6.3.2. Compression-ignition engines:

- 6.3.2.1. Where fitted, replacement of the catalyst with a deteriorated or defective catalyst or electronic simulation of such a failure.
- 6.3.2.2. Where fitted, total removal of the particulate trap or, where sensors are an integral part of the trap, a defective trap assembly.
- 6.3.2.3. Electrical disconnection of any fuelling system electronic fuel quantity and timing actuator.
- 6.3.2.4. Electrical disconnection of any other emission-related component connected to a powertrain management computer.
- 6.3.2.5. In meeting the requirements of 6.3.2.3 and 6.3.2.4, and with the agreement of the approval authority, the manufacturer must take appropriate steps to demonstrate that the OBD system will indicate a fault when disconnection occurs.

6.4. OBD system test*6.4.1. Vehicles fitted with positive-ignition engines:*

- 6.4.1.1. After vehicle preconditioning according to 6.2, the test vehicle is driven over a Type I test (Parts One and Two). The MI must activate before the end of this test under any of the conditions given in 6.4.1.2 to 6.4.1.5. The technical service may substitute those conditions by others in accordance with 6.4.1.6. However, the total number of failures simulated must not exceed 4 for the purpose of type-approval.
- 6.4.1.2. Replacement of a catalyst with a deteriorated or defective catalyst or electronic simulation of a deteriorated or defective catalyst that results in emissions exceeding the HC limit given in section 3.3.2 of this Annex.
- 6.4.1.3. An induced misfire condition according to the conditions for misfire monitoring given in section 3.3.3.2 of this Annex that results in emissions exceeding any of the limits given in 3.3.2.
- 6.4.1.4. Replacement of an oxygen sensor with a deteriorated or defective oxygen sensor or electronic simulation of a deteriorated or defective oxygen sensor that results in emissions exceeding any of the limits given in section 3.3.2 of this Annex.
- 6.4.1.5. Electrical disconnection of the electronic evaporative purge control device (if equipped).
- 6.4.1.6. Electrical disconnection of any other emission-related powertrain component connected to a computer that results in emissions exceeding any of the limits given in section 3.3.2 of this Annex.

▼ **M15**6.4.2. *Vehicles fitted with compression-ignition engines:*

- 6.4.2.1. After vehicle preconditioning according to 6.2, the test vehicle is driven over a Type I test (Parts One and Two). The MI must activate before the end of this test under any of the conditions given in 6.4.2.2 to 6.4.2.5. The technical service may substitute those conditions by others in accordance with 6.4.2.5. However, the total number of failures simulated must not exceed four for the purposes of type approval.
- 6.4.2.2. Where fitted, replacement of a catalyst with a deteriorated or defective catalyst or electronic simulation of a deteriorated or defective catalyst that results in emissions exceeding limits given in section 3.3.2 of this Annex.
- 6.4.2.3. Where fitted, total removal of the particulate trap or replacement of the particulate trap with a defective particulate trap meeting the conditions of 6.3.2.2 that results in emissions exceeding the limits given in section 3.3.2 of this Annex.
- 6.4.2.4. With reference to 6.3.2.5, disconnection of any fuelling system electronic fuel quantity and timing actuator that results in emissions exceeding any of the limits given in section 3.3.2 of this Annex.
- 6.4.2.5. With reference to 6.3.2.5, disconnection of any other emission-related powertrain component connected to a computer that results in emissions exceeding any of the limits given in section 3.3.2 of this Annex.

6.5. **Diagnostic signals**

- 6.5.1.1. Upon determination of the first malfunction of any component or system, 'freeze-frame' engine conditions present at the time must be stored in computer memory. Should a subsequent fuel system or misfire malfunction occur, any previously stored freeze-frame conditions must be replaced by the fuel system or misfire conditions (whichever occurs first). Stored engine conditions must include, but are not limited to calculated load value, engine speed, fuel trim value(s) (if available), fuel pressure (if available), vehicle speed (if available), coolant temperature, intake manifold pressure (if available), closed- or open-loop operation (if available) and the fault code which caused the data to be stored. The manufacturer must choose the most appropriate set of conditions facilitating effective repairs for freeze-frame storage. Only one frame of data is required. Manufacturers may choose to store additional frames provided that at least the required frame can be read by a generic scan tool meeting the specifications of 6.5.3.2 and 6.5.3.3. If the fault code causing the conditions to be stored is erased in accordance with section 3.7 of this Annex, the stored engine conditions may also be erased.
- 6.5.1.2. If available, the following signals in addition to the required freeze-frame information must be made available on demand through the serial port on the standardized data link connector, if the information is available to the on-board computer or can be determined using information available to the on-board computer: diagnostic trouble codes, engine coolant temperature, fuel control system status (closed-loop, open-loop, other), fuel trim, ignition timing advance, intake air temperature, manifold air pressure, air flow rate, engine speed, throttle position sensor output value, secondary air status (upstream, downstream or atmosphere), calculated load value, vehicle speed and fuel pressure.

The signals must be provided in standard units based on the specifications given in 6.5.3. Actual signals must be clearly identified separately from default value or limp-home signals. In addition, the capability to perform bi-directional diagnostic control based on the specifications given in 6.5.3 must be made available on demand through the serial port on the standardized data link connector according to the specifications given in 6.5.3.

- 6.5.1.3. For all emission control systems for which specific on-board evaluation tests are conducted (catalyst, oxygen sensor, etc.), except misfire detection, fuel system monitoring and comprehensive component monitoring, the results of the most recent test performed by the vehicle and the limits to which the system is compared must be made available through the serial data port on the standardized data link connector according to the specifications given in 6.5.3. For the monitored components and systems excepted above, a pass/fail indication for the most recent test results must be available through the data link connector.
- 6.5.1.4. The OBD requirements to which the vehicle is certified (i. e. this Annex or the alternative requirements specified in section 5 of Annex I) and the major emission control systems monitored by the OBD

▼ **M15**

system consistent with 6.5.3.3 must be available through the serial data port on the standardized data link connector according to the specifications given in 6.5.3.

- 6.5.2. The emission control diagnostic system is not required to evaluate components during malfunction if such evaluation would result in a risk to safety or component failure.
- 6.5.3. The emission control diagnostic system must provide for standardised and unrestricted access and conform with the following ISO and/or SAE standards. Some of the ISO standards have been derived from Society of Automotive Engineers Standards and Recommended Practices. Where this is the case, the appropriate SAE reference appears in parentheses.
- 6.5.3.1. One of the following standards with the restrictions as described must be used as the on-board to off-board communications link:
- ISO 9141-2 'Road Vehicles — Diagnostic Systems — CARB Requirements for the Interchange of Digital Information';
- ISO 11519-4 'Road Vehicles — Low Speed Serial Data Communication — Part 4: Class B Data Communication Interface (SAE J1850)'. Emission-related messages must use the cyclic redundancy check and the three-byte header and not use inter-byte separation or checksums.
- ISO DIS 14230 — Part 4 'Road Vehicles — Diagnostic Systems — Keyword Protocol 2000'.
- 6.5.3.2. Test equipment and diagnostic tools needed to communicate with OBD systems must meet or exceed the functional specification given in ISO DIS 15031-4.
- 6.5.3.3. Basic diagnostic data, (as specified in 6.5.1) and bi-directional control information must be provided using the format and units described in ISO DIS 15031-5 and must be available using a diagnostic tool meeting the requirements of ISO DIS 15031-4.
- 6.5.3.4. When a fault is registered, the manufacturer must identify the fault using the most appropriate fault code consistent with those given in section 6.3 of ISO DIS 15031-6 (SAE J2012 — dated July 1996), relating to '... Powertrain system diagnostic trouble codes'. The fault codes must be fully accessible by standardized diagnostic equipment complying with the provisions of 6.5.3.2.
- The note in section 6.3 of ISO DIS 15031-6 (SAE J2012 — dated July 1996) immediately preceding the list of fault codes in the same section does not apply.
- 6.5.3.5. The connection interface between the vehicle and the diagnostic tester must meet all the requirements of ISO DIS 15031-3. The installation position must be subject to agreement of the approval authority such that it is readily accessible by service personnel but protected from tampering by non-qualified personnel.
- 6.5.3.6. The manufacturer must also make accessible, where appropriate upon payment, to repairers who are not undertakings within the distribution system, the technical information required for the repair or maintenance of motor vehicles unless that information is covered by an intellectual property right or constitutes essential, secret know-how which is identified in an appropriate form; in such case, the necessary technical information must not be withheld improperly.

▼ **M15***Appendix 2***ESSENTIAL CHARACTERISTICS OF THE VEHICLE FAMILY**

1. PARAMETERS DEFINING THE OBD FAMILY

The OBD family may be defined by basic design parameters which must be common to vehicles within the family. In some cases there may be interaction of parameters. These effects must also be taken into consideration to ensure that only vehicles with similar exhaust emission characteristics are included within an OBD family.

2. To this end, those vehicle types whose parameters described below are identical are considered to belong to the same engine-emission control/OBD system combination.

Engine:

- combustion process (i. e. positive-ignition, compression-ignition, two-stroke, four-stroke),
- method of engine fuelling (i. e. carburettor or fuel injection).

Emission control system:

- type of catalytic converter (i. e. oxidation, three-way, heated catalyst, other),
- type of particulate trap,
- secondary air injection (i. e. with or without),
- exhaust gas recirculation (i. e. with or without)

OBD parts and functioning:

- the methods of OBD functional monitoring, malfunction detection and malfunction indication to the vehicle driver.

▼ **M14***ANNEX XII***EC TYPE-APPROVAL FOR A VEHICLE FUELLED BY LPG OR NATURAL GAS WITH REGARD TO ITS EMISSIONS****1. INTRODUCTION**

This Annex describes the special requirements that apply in the case of an approval of a vehicle that runs on LPG or natural gas, or that can run either on unleaded petrol or LPG or natural gas, in so far as the testing on LPG or natural gas is concerned.

In the case of LPG and natural gas there is on the market a large variation in fuel composition, requiring the fuelling system to adapt its fuelling rates to these compositions. To demonstrate this capability, the vehicle has to be tested in the test type I on two extreme reference fuels and demonstrate the self-adaptability of the fuelling system. Whenever the self adaptability of a fuelling system has been demonstrated on a vehicle, such a vehicle may be considered as a parent of a family. Vehicles that comply with the requirements of members of that family, if fitted with the same fuelling system, need to be tested on only one fuel.

2. DEFINITIONS

For the purpose of this Annex:

- 2.1. A parent vehicle means a vehicle that is selected to act as the vehicle on which the self adaptability of a fuelling system is going to be demonstrated, and to which the members of a family refer. It is possible to have more than one parent vehicle in a family.
- 2.2. A member of the family is a vehicle that shares the following essential characteristics with its parent(s):
 - 2.2.1. (a) It is produced by the same vehicle manufacturer.
 - (b) It is subject to the same emission limits.
 - (c) If the gas fuelling system has a central metering for the whole engine:

It has a certified power output between 0,7 and 1,15 times that of the engine of the parent vehicle.

If the gas fuelling system has an individual metering per cylinder:

It has a certified power output per cylinder between 0,7 and 1,15 times that of the engine of the parent vehicle.
 - (d) If fitted with a catalyst system, it has the same type of catalyst i.e. three-way, oxidation, de NOx.
 - (e) It has a gas fuelling system (including the pressure regulator) from the same system manufacturer and of the same type: induction, vapour injection (single point, multipoint), liquid injection (single point, multipoint).
 - (f) This gas fuelling system is controlled by an ECU of the same type and technical specification, containing the same software principles and control strategy.
- 2.2.2. With regard to requirement (c): in the case where a demonstration shows two gas fuelled vehicles could be members of the same family with the exception of their certified power output, respectively P1 and P2 ($P1 < P2$), and both are tested as if they were parent vehicles, the family relation will be considered valid for any vehicle with a certified power output between $0,7 * P1$ and $1,15 * P2$.

3. GRANTING OF AN EC TYPE-APPROVAL

EC type-approval is granted subject to the following requirements:

3.1. Exhaust emissions approval of a parent vehicle:

The parent vehicle should demonstrate its capability to adapt to any fuel composition that may occur across the market. In the case of LPG there are variations in C3/C4 composition. In the case of natural gas there are generally two types of fuel, high calorific fuel (H-gas) and low calorific fuel (L-gas), but with a significant spread within both ranges; they differ significantly in Wobbe index. These variations are reflected in the reference fuels.

▼M14

- 3.1.1. The parent vehicle(s) shall be tested in the test type I on the two extreme reference fuels of Annex IXa.
- 3.1.1.1. If the transition from one fuel to another is in practice aided through the use of a switch, this switch shall not be used during type approval. In such a case on the manufacturer's request and with the agreement of the technical service the pre-conditioning cycle referred to in point 5.3.1 of Annex III may be extended.
- 3.1.2. The vehicle(s) is (are) considered to conform if, with both reference fuels, the vehicle complies with the emission limits.
- 3.1.3. The ratio of emission results 'r' should be determined for each pollutant as follows:

$$r = \frac{\{\text{emission result on one reference fuel}\}}{\{\text{emission result on the other reference fuel}\}}$$

- 3.2. Exhaust emissions approval of a member of the family:
- For a member of the family a test of type I shall be performed with one reference fuel. This reference fuel may be either reference fuel. The vehicle is considered to comply if the following requirements are met:
- 3.2.1. The vehicle complies with the definition of a family member as defined under point 2.2.
- 3.2.2. The test results for each pollutant will be multiplied with its factor 'r' (see point 3.1.3), if r is greater than 1,0. If r is smaller than 1,0, its value will be taken as 1. The results of these multiplications shall be taken as the final emission result. On the manufacturer's request the test type I may be performed on reference fuel 2 or on both reference fuels, so that no correction is needed.
- 3.2.3. The vehicle shall comply with the emission limits valid for the relevant category for both measured and calculated emissions.

4. GENERAL CONDITIONS

- 4.1. Tests for conformity of production may be performed with a commercial fuel of which the C3/C4 ratio lies between those of the reference fuels in the case of LPG, or of which the Wobbe index lies between those of the extreme reference fuels in the case of NG. In that case a fuel analysis needs to be present.

▼ **M14***ANNEX XIII***EC TYPE-APPROVAL OF REPLACEMENT CATALYTIC CONVERTER AS SEPARATE TECHNICAL UNIT****1. SCOPE**

This Annex applies to the EC type-approval, as separate technical units within the meaning of Article 4(1)(d) of Directive 70/156/EEC, of catalytic converters to be fitted on one or more given types of motor vehicles of categories M₁ and N₁⁽¹⁾ as replacement parts⁽²⁾.

2. DEFINITIONS

For the purpose of this Annex:

- 2.1. 'Original equipment catalytic converter', see point 2.17 of Annex I.
- 2.2. 'Replacement catalytic converter', see point 2.18 of Annex I.
- 2.3. 'Type of catalytic converter' means catalytic converters which do not differ in such essential aspects as:
 - 2.3.1. number of coated substrates, structure and material;
 - 2.3.2. type of catalytic activity (oxidising, three-way, etc.);
 - 2.3.3. volume, ratio of frontal area and substrate length;
 - 2.3.4. catalyst material content;
 - 2.3.5. catalyst material ratio;
 - 2.3.6. cell density;
 - 2.3.7. dimensions and shape;
 - 2.3.8. thermal protection.
- 2.4. 'Vehicle type', see point 2.1 of Annex I.
- 2.5. 'Approval of a replacement catalytic converter' means the approval of a converter intended to be fitted as a replacement part on one or more specific types of vehicles with regard to the limitation of pollutant emissions, noise level and effect on vehicle performance.

3. APPLICATION FOR EC TYPE-APPROVAL

- 3.1. An application for EC type-approval pursuant to Article 3(4) of Directive 70/156/EEC of a type of replacement catalytic converter shall be submitted by the manufacturer.
- 3.2. A model for the information document is given in Appendix 1 to this Annex.
- 3.3. The following must be submitted to the technical service responsible for the type-approval test:
 - 3.3.1. Vehicle(s) of a type approved in accordance with Directive 70/220/EEC equipped with a new original catalytic converter. This (these) vehicle(s) shall be selected by the applicant with the agreement of the technical service. It (they) shall comply with the requirements of Section 3 of Annex III to this Directive.

The test vehicle(s) shall have no emission control system defects; any excessively worn out or malfunctioning emission-related original part shall be repaired or replaced. The test vehicle(s) shall be tuned properly and set to manufacturer's specification prior to emission testing.
 - 3.3.2. One sample of the type of the replacement catalytic converter. This sample shall be clearly and indelibly marked with the applicant's trade name or mark and its commercial designation.

⁽¹⁾ As defined in Annex II Section A to Directive 70/156/EEC.

⁽²⁾ This Annex does not apply to replacement catalytic converters intended to be fitted on vehicles of categories M₁ and N₁ equipped with an on-board diagnostic (OBD) system.

▼ **M14**

4. GRANTING OF EC TYPE-APPROVAL

- 4.1. If the relevant requirements are satisfied, EC type-approval pursuant to Article 4(3) of Directive 70/156/EEC shall be granted.
- 4.2. A model for the EC type-approval certificate is given in Appendix 2 to this Annex.
- 4.3. An approval number in accordance with Annex VII to Directive 70/156/EEC shall be assigned to each type of replacement catalytic converter approved. The same Member State shall not assign the same number to another replacement catalytic converter type. The same type-approval number may cover the use of that replacement catalytic converter type on a number of different vehicle types.

5. EC TYPE-APPROVAL MARKING

- 5.1. Every replacement catalytic converter conforming to the type approved under this Directive as a separate technical unit shall bear an EC type-approval mark.
- 5.2. This mark shall consist of a rectangle surrounding the letter 'e' followed by the distinguishing number or letters of the Member State which has granted the EC type-approval:

| | |
|-----|------------------------|
| 1 | for Germany |
| 2 | for France |
| 3 | for Italy |
| 4 | for the Netherlands |
| 5 | for Sweden |
| 6 | for Belgium |
| 9 | for Spain |
| 11 | for the United Kingdom |
| 12 | for Austria |
| 13 | for Luxembourg |
| 17 | for Finland |
| 18 | for Denmark |
| 21 | for Portugal |
| 23 | for Greece |
| IRL | for Ireland |

It must also include in the vicinity of the rectangle the 'base approval number' contained in point 4 of the type-approval number referred to in Annex VII to Directive 70/156/EEC, preceded by the two figures indicating the sequence number assigned to the most recent major technical amendment to Directive 70/220/EEC on the date EC component type-approval was granted. In this Directive, the sequence number is 00.

- 5.3. The approval mark referred to in point 5.2 shall be clearly legible and indelible.
- 5.4. Appendix 3 to this Annex gives examples of arrangements of the approval mark and approval data referred to above.

6. REQUIREMENTS

6.1. General requirements

- 6.1.1. The replacement catalytic converter shall be designed, constructed and capable of being mounted so as to enable the vehicle to comply with the provisions of this Directive which it was originally in compliance with and that pollutant emissions are effectively limited throughout the normal life of the vehicle under normal conditions of use.
- 6.1.2. The installation of the replacement catalytic converter shall be at the exact position of the original equipment catalytic converter, and the position on the exhaust line of the oxygen probe(s), if applicable, shall not be modified.
- 6.1.3. If the original equipment catalytic converter includes thermal protection, the replacement catalytic converter shall include equivalent protection.
- 6.1.4. The replacement catalytic converter shall be durable, that is, designed, constructed and capable of being mounted so that reasonable resistance to the corrosion and oxidation phenomena to which it is exposed is obtained, having regard to the conditions of use of the vehicle.

6.2. Requirements regarding emissions

▼ **M14**

The vehicle(s) indicated in point 3.3.1 of this Annex, equipped with a replacement converter of the type for which approval is requested, shall be subjected to a Type I test under the conditions described in the corresponding Annex to this Directive in order to compare its performance with the original catalytic converter according to the procedure described below.

6.2.1. Determination of the basis for comparison

The vehicle(s) shall be fitted with a new original catalytic converter (see point 3.3.1) which shall be run in with 12 extra urban cycles (type I test part 2).

After this preconditioning, the vehicle(s) shall be kept in a room in which the temperature remains relatively constant between 293 and 303 K (20 and 30 °C). This conditioning shall be carried out for at least six hours and continue until the engine oil and coolant temperature are within ± 2 K of the temperature of the room. Subsequently three type I tests shall be made.

6.2.2. Exhaust gas test with replacement catalytic converter

The original equipment catalytic converter of the test vehicle(s) shall be replaced by the replacement catalytic converter (see point 3.3.2) which shall be run in with 12 extra urban cycles (type I test part 2).

After this preconditioning, the vehicle(s) shall be kept in a room in which the temperature remains relatively constant between 293 and 303 K (20 and 30 °C). This conditioning shall be carried out for at least six hours and continue until the engine oil and coolant temperature are within ± 2 K of the temperature of the room. Subsequently three type I tests shall be made.

6.2.3. Evaluation of the emission of pollutants of vehicles equipped with replacement catalytic converters

The test vehicle(s) with the original equipment catalytic converter shall comply with the limit values according to the type-approval of the vehicle(s) including, if applicable, the deterioration factors applied during the type-approval of the vehicle(s).

The requirements regarding emissions of the vehicle(s) equipped with the replacement catalytic converter shall be deemed to be fulfilled if the results meet for each regulated pollutant (CO, HC + NO_x and particulates) the following conditions:

$$M \leq 0,85 S + 0,4 G \quad (1)$$

$$M \leq G \quad (2)$$

where:

M mean value of the emissions of one pollutant (CO or particulates) or the sum of two pollutants (HC + NO_x) obtained from the three type I tests with the replacement catalytic converter.

S mean value of the emissions of one pollutant (CO or particulates) or the sum of two pollutants (HC + NO_x) obtained from the three type I tests with the original catalytic converter.

G limit value of the emissions of one pollutant (CO or particulates) or of the sum of two pollutants (HC + NO_x) according to the type-approval of the vehicle(s) divided by, if applicable, the deterioration factors determined in accordance with point 6.4.

Where approval is applied for different types of vehicles from the same car manufacturer, and provided that these different types of vehicle are fitted with the same type of original equipment catalytic converter, the type I test may be limited to at least two vehicles selected after agreement with the technical service responsible for approval.

6.3. Requirements regarding noise and exhaust back-pressure

The replacement catalytic converter shall satisfy the technical requirements of Annex II to Directive 70/157/EEC.

6.4. Requirements regarding durability

The replacement catalytic converter shall comply with the requirements of point 5.3.5 of Annex I to this Directive, i.e. type V test or deterioration factors from the following table for the results of the type I tests.

▼ **M14****Table XIII.6.4**

| Engine category | Deterioration factors | | |
|----------------------|-----------------------|----------------------|--------------|
| | CO | HC + NO _x | Particulates |
| Positive ignition | 1,2 | 1,2 | — |
| Compression ignition | 1,1 | 1,0 | 1,2 |

7. MODIFICATION OF THE TYPE AND AMENDMENTS TO APPROVALS

In the case of modification of the type approved pursuant to this Directive, the provisions of Article 5 of Directive 70/156/EEC shall apply.

8. CONFORMITY OF PRODUCTION

Measures to ensure the conformity of production shall be taken in accordance with the provisions laid down in Article 10 of Directive 70/156/EEC.

8.2. Special provisions

8.2.1. The checks referred to in point 2.2 of Annex X to Directive 70/156/EEC shall include compliance with the characteristics as defined under point 2.3 to this Annex.

8.2.2. For the application of point 2.4.4 of Annex X to Directive 70/156/EEC, the tests described in point 6.2 of this Annex (requirements regarding emissions) may be carried out. In this case, the holder of the approval may ask, as an alternative, to use as a basis for comparison not the original equipment catalytic converter, but the replacement catalytic converter which was used during the type-approval tests (or another sample that has been proven to conform to the approved type). Emissions values measured with the sample under verification shall then on average not exceed by more than 15 % the mean values measured with the sample used for reference.

▼ **M14***Appendix 1***Information document No ... relating to the EC type-approval of replacement catalytic converters (Directive 70/220/EEC as last amended by Directive ...)**

The following information, if applicable, must be supplied in triplicate and include a list of contents. Any drawings must be supplied in appropriate scale and sufficient detail on size A4 or on a folder of A4 format. Photographs, if any, must show sufficient detail.

If the system, components or separate technical units have electronic controls, information concerning their performance must be supplied.

0. GENERAL
 - 0.1. Make (trade name of manufacturer):
 - 0.2. Type:
 - 0.5. Name and address of manufacturer:
 - 0.7. In the case of components and separate technical units, location and method of affixing of the EC approval mark:
 - 0.8. Address(es) of assembly plant(s):
1. DESCRIPTION OF THE DEVICE
 - 1.1. Make and type of the replacement catalytic converter:
 - 1.2. Drawings of the replacement catalytic converter, identifying in particular all the characteristics referred to in Section 2.3 of this Annex:
 - 1.3. Description of the vehicle type or types for which the replacement catalytic converter is intended:
 - 1.3.1. Number(s) and/or symbol(s) characterising the engine and vehicle type(s):
 - 1.4. Description and drawings showing the position of the replacement catalytic converter relative to the engine exhaust manifold(s):

▼ **M14***Appendix 2***Model**

(Maximum format: A4 (210 mm × 297 mm))

EC TYPE-APPROVAL CERTIFICATE

| |
|--|
| <p style="text-align: center;">STAMP OF ADMINISTRATION</p> |
|--|

Communication concerning the

- type-approval ⁽¹⁾,
- extension of type-approval ⁽¹⁾,
- refusal of type-approval ⁽¹⁾,
- withdrawal of type-approval ⁽¹⁾,

of a type of vehicle/component/separate technical unit ⁽¹⁾ with regard to Directive,
as last amended by Directive

Type-approval number:

Reason for extension:

SECTION I

- 0.1. Make (trade name of manufacturer):
- 0.2. Type:
- 0.3. Means of identification of type if marked on the vehicle/component/separate technical unit ⁽¹⁾ ⁽²⁾:
- 0.3.1. Location of that marking:
- 0.4. Category of vehicle ⁽¹⁾ ⁽³⁾:
- 0.5. Name and address of manufacturer:
- 0.7. In the case of components and separate technical units, location and method of affixing of the EC approval mark:
- 0.8. Address(es) of assembly plant(s):

⁽¹⁾ Delete where not applicable.

⁽²⁾ If the means of identification of type contains characters not relevant to describe the vehicle, component or separate technical unit types covered by this type-approval certificate such characters shall be represented in the document by the symbol: “?” (e.g. ABC??123??).

⁽³⁾ As defined in Annex II Section A to Directive 70/156/EEC.

▼ M14

SECTION II

1. Additional information (where applicable): See addendum
2. Technical service responsible for carrying out the tests:
3. Date of test report:
4. Number of test report:
5. Remarks (if any): See addendum
6. Place:
7. Date:
8. Signature:
9. The index to the information package lodged with the approval authority, which may be obtained on request, is attached.

▼ **M14**

Addendum

to EC type-approval certificate No ...

concerning the separate technical unit type-approval of replacement catalytic converters for motor vehicles with regard to Directive 70/220/EEC as last amended by Directive ...

1. **Additional information**
- 1.1. **Make and type of the replacement catalytic converter:**
- 1.2. **Vehicle type(s) for which the catalytic converter type qualifies as replacement part:**
- 1.3. **Type(s) of vehicle(s) on which the replacement catalytic converter has been tested:**
5. **Remarks:**

▼ M14*Appendix 3***Model for the EC type-approval marks**

(see point 5.2 of this Annex)

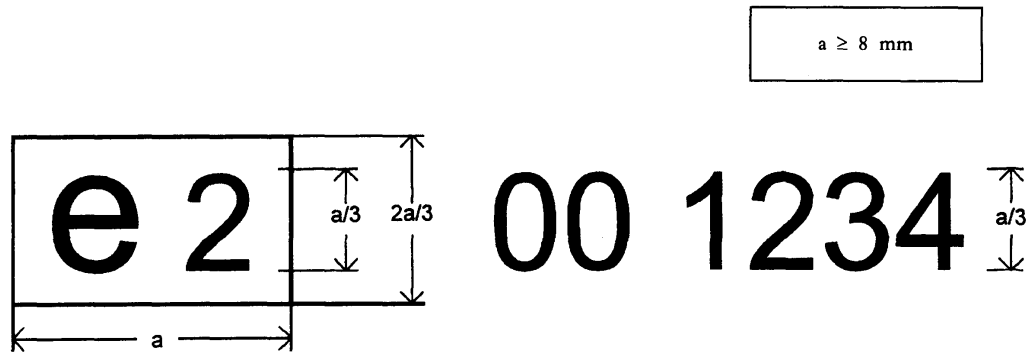

The above approval mark affixed to a component of a replacement catalytic converter shows that the type concerned has been approved in France (e 2), pursuant to this Directive. The first two digits of the approval number (00) refer to the sequence number assigned to the most recent amendments made to Directive 70/220/EEC. The following four digits (1234) are those allocated by the approval authority to the replacement catalytic converter as the base approval number.