

This document is meant purely as a documentation tool and the institutions do not assume any liability for its contents

► **B**

**COUNCIL DIRECTIVE 92/23/EEC**  
**of 31 March 1992**  
**relating to tyres for motor vehicles and their trailers and to their fitting**

(OJ L 129, 14.5.1992, p. 95)

Amended by:

		Official Journal		
		No	page	date
► <b><u>M1</u></b>	Directive 2001/43/EC of the European Parliament and of the Council of 27 June 2001	L 211	25	4.8.2001
► <b><u>M2</u></b>	Commission Directive 2005/11/EC of 16 February 2005	L 46	42	17.2.2005

Amended by:

► <b><u>A1</u></b>	Act of Accession of Austria, Sweden and Finland	C 241	21	29.8.1994
	(adapted by Council Decision 95/1/EC, Euratom, ECSC)	L 1	1	1.1.1995



**COUNCIL DIRECTIVE 92/23/EEC**  
**of 31 March 1992**

**relating to tyres for motor vehicles and their trailers and to their fitting**

THE COUNCIL OF THE EUROPEAN COMMUNITIES,

Having regard to the Treaty establishing the European Economic Community, and in particular Article 100a thereof,

Having regard to the proposal from the Commission <sup>(1)</sup>,

In cooperation with the European Parliament <sup>(2)</sup>,

Having regard to the opinion of the Economic and Social Committee <sup>(3)</sup>,

Whereas measures should be adopted in order gradually to establish the internal market during a period expiring on 31 December 1992; whereas the internal market comprises an entity without internal frontiers within which the free movement of goods, persons, services and capital shall be guaranteed;

Whereas the total harmonization method will be essential in order fully to achieve the single market;

Whereas this method will have to be used at the time of the revision of the entire ►**M1** EC type-approval ◀ procedure, taking account of the spirit of the Council resolution of 7 May 1985 concerning a new approach to the question of technical harmonization and standardization;

Whereas the technical requirements which motor vehicles and their trailers must satisfy pursuant to national laws relate, *inter alia*, to pneumatic tyres;

Whereas these requirements differ from one Member State to another; whereas it is therefore necessary that all Member States adopt the same requirements either in addition to or in place of their existing rules in order to permit, in particular, the ►**M1** EC type-approval ◀ procedure which was the subject of Council Directive 70/156/EEC of 6 February 1970 on the approximation of the laws of the Member States relating to the type-approval of motor vehicles and their trailers <sup>(4)</sup>, as last amended by Directive 87/403/EEC <sup>(5)</sup>, to be introduced in respect of each type of vehicle;

Whereas rules on tyres should lay down common requirements concerning not only their characteristics, but also the requirements for the equipment of vehicles and their trailers with regard to their tyres;

Whereas, consequently, a common procedure for granting an EEC mark to any tyre type complying with the common characteristics and test requirements should be established; whereas, at the Community level, to ensure the free movement of tyres, the conformity of the tyres with the common requirements is assured by the affixing on each tyre of an EEC mark which has been granted to the manufacturer in accordance with the abovementioned procedure; whereas any Member States may, in order to check the conformity of the tyres with the common requirements, carry out controls at any moment; whereas, in the case of a statement of non-conformity, the Member States need to take the necessary steps to ensure the conformity of the tyres with the requirements; whereas these measures may result in the withdrawal of the abovementioned EEC mark;

Whereas it is desirable to take into account the technical requirements adopted by the UN Economic Commission for Europe in its

<sup>(1)</sup> OJ No C 95, 12. 4. 1990, p. 101.

<sup>(2)</sup> OJ No C 284, 12. 11. 1990, p. 81 and Decision of 12. 2. 1992 (not yet published in the Official Journal).

<sup>(3)</sup> OJ No C 225, 10. 9. 1990, p. 9.

<sup>(4)</sup> OJ No L 42, 23. 2. 1970, p. 1.

<sup>(5)</sup> OJ No L 220, 8. 8. 1987, p. 44.

**▼B**

Regulation No 30 ('Uniform provisions concerning the approval of pneumatic tyres for motor vehicles and their trailers'), as amended <sup>(1)</sup>, and in its Regulation No 54 ('Uniform provisions concerning the approval of pneumatic tyres for commercial vehicles and their trailers') <sup>(2)</sup> and in its Regulation No 64 ('Uniform provisions concerning the approval of vehicles equipped with temporary-use spare wheels/tyres') <sup>(3)</sup>, which are annexed to the Agreement of 20 March 1958 concerning the adoption of uniform conditions for approval and reciprocal recognition of approval for motor vehicle equipment and parts;

Whereas the approximation of national laws relating to motor vehicles entails reciprocal recognition by Member States of the checks carried out by each of them on the basis of the common requirements,

HAS ADOPTED THIS DIRECTIVE:

*Article 1*

For the purposes of this Directive:

**▼M1**

— 'tyre' means any new pneumatic tyre including a winter tyre with holes for studs, in the form of original equipment or of a replacement, intended to be fitted to vehicles to which Directive 70/156/EEC applies. This definition does not cover winter tyres with studs;

**▼B**

- 'vehicle' means any vehicle to which Council Directive 70/156/EEC applies;
- 'manufacturer' means the holder of the trade name or mark of vehicles or tyres.

**▼M1**

*Article 1a*

1. The requirements set out in Annex V shall apply to tyres intended to be fitted to vehicles first used on or after 1 October 1980.
2. The requirements set out in Annex V shall not apply to:
  - (a) tyres whose speed rating is less than 80 km/h;
  - (b) tyres whose nominal rim diameter does not exceed 254 mm (or code 10) or is 635 mm or more (code 25);
  - (c) T type temporary use spare tyres as defined in 2.3.6 of Annex II;
  - (d) tyres designed only to be fitted to vehicles registered for the first time before 1 October 1980.

*Article 2*

1. Member States shall grant EC type-approval, under the conditions laid down in Annex I, to all types of tyres meeting the requirements of Annex II, and shall allocate to these an approval number as specified in Annex I.
2. Member States shall grant EC type-approval, under the conditions laid down in Annex I, to all types of tyres meeting the requirements of Annex V and shall allocate to these an approval number as specified in Annex I.

<sup>(1)</sup> Economic Commission for Europe document E/ECE/324 (E3/ECE/TRANS/505) REV 1 — ADD 29, 1. 4. 1975 and its amendments 01, 02 and supplements.

<sup>(2)</sup> Economic Commission for Europe document E/ECE/324 (E/ECE/TRANS/505) REV 1 — ADD 53 and supplements.

<sup>(3)</sup> Economic Commission for Europe document E/ECE/324 (E/ECE/TRANS/505) REV 1 — ADD 63 and supplements.

▼ **M1**

3. Member States shall grant EC type-approval to all vehicles in respect of their tyres under the conditions laid down in Annex III, where those tyres (including spare tyres, where appropriate) meet the requirements of Annex II and the requirements concerning vehicles laid down in Annex IV, and shall allocate to any such vehicle an approval number as specified in Annex III

▼ **B***Article 3*

The approval authority of a Member State shall, within one month of issuing or refusing an ► **M1** EC type-approval ◀ (tyre) or vehicle EC type-approval, send a copy of the relevant certificate, models of which are given in the Appendices to Annex I and Annex III, to the other Member States and, if requested, send the test report on any type of tyre approved.

*Article 4*

No Member State may prohibit or restrict the placing on the market of tyres bearing the ► **M1** EC type-approval ◀ mark.

*Article 5*

No Member State may refuse to grant ► **M1** EC type-approval ◀ or national type-approval to a vehicle on grounds relating to its tyres if these bear the ► **M1** EC type-approval ◀ mark and are fitted in accordance with the requirements laid down in Annex IV.

*Article 6*

No Member State may refuse or prohibit the sale, registration, entry into service or use of a vehicle on grounds relating to its tyres if these bear the ► **M1** EC type-approval ◀ mark and are fitted in accordance with the requirements laid down in Annex IV.

*Article 7*

1. If, on the basis of a substantiated justification, a Member State considers that a tyre type or a vehicle type is dangerous although complying with the requirements of this Directive, it may, within its territory, provisionally prohibit the marketing of that product or subject it to special conditions. It shall immediately inform the other Member States and the Commission thereof, stating the grounds for its decision.

2. The Commission shall, within six weeks, consult the Member States concerned, following which it shall deliver its opinion without delay and take the appropriate steps.

3. If the Commission is of the opinion that technical adaptations to the Directives are necessary, such adaptations shall be adopted by either the Commission or the Council in accordance with the procedure laid down in Article 10. In this event, the Member State which has adopted safeguard measures may maintain them until the entry into force of the adaptations.

*Article 8*

1. The Member State which has granted the ► **M1** EC type-approval ◀ (tyre) or vehicle type-approval shall take the measures required in order to verify that production models conform to the approved type in so far as this is necessary and if need be in cooperation with the approval authorities in the other Member States. For this purpose, this Member State may at any time check the conformity of the tyres or vehicles to the requirements of this Directive. Such verification shall be limited to spot checks.

2. If this Member State finds that a number of tyres or vehicles with the same approval marking do not conform to the approved type, it shall take the necessary measures to ensure that production models so conform. Where there is a consistent failure to conform, these

**▼B**

measures may extend to a withdrawal of ►**M1** EC type-approval ◀. The said authorities shall take the same measure if they are informed by the approval authorities of another Member State of such failure to conform.

3. The approval authorities of the Member States shall within one month notify each other using the relevant form shown in the Appendices to Annex I and Annex III of any withdrawal of ►**M1** EC type-approval ◀ and of the reasons for such a measure.

*Article 9*

Any decision taken pursuant to the provisions adopted in implementation of this Directive to refuse or withdraw ►**M1** EC type-approval ◀ for a tyre or ►**M1** EC type-approval ◀ of a vehicle with regard to the fitting of its tyres implying a prohibition of marketing or of use shall set out in detail the reasons on which it is based. Every such decision shall be notified to the party concerned, who shall at the same time be informed of the remedies available to him under the laws in force in the Member States and of the time limits allowed for the exercise of such remedies.

*Article 10*

Any amendments necessary to adapt the requirements of the Annexes to technical progress shall be adopted in accordance with the procedure laid down in Article 13 of Directive 70/156/EEC.

**▼M1***Article 10a*

1. As from 4 February 2003, Member States may not:

- (a) refuse to grant EC type-approval or national approval for a type of vehicle or type of tyre, or
- (b) prohibit the registration, sale or entry into service of vehicles, and the sale or entry into service or use of tyres,

for reasons relating to the tyres and their fitting to new vehicles, if the vehicles or tyres comply with the requirements laid down in this Directive, as amended by Directive 2001/43/EC <sup>(1)</sup>.

2. As from 4 August 2003, Member States may no longer grant EC type-approval, and shall refuse to grant national type-approval for those types of tyre which fall within the scope of this Directive and which do not meet the requirements of this Directive, as amended by Directive 2001/43/EC.

3. As from 4 February 2004, Member States may no longer grant EC type-approval or national approval for a type of vehicle, for reasons relating to its tyres or their fitting, if the requirements of this Directive, as amended by Directive 2001/43/EC, are not met.

4. As from 4 February 2005, Member States shall:

- (a) consider certificates of conformity accompanying new vehicles in accordance with the provisions of Directive 70/156/EEC as being no longer valid for the purposes of Article 7(1) of the said Directive, if the requirements of this Directive, as amended by Directive 2001/43/EC, are not met, and
- (b) refuse the registration or prohibit the sale or entry into service of new vehicles which do not meet the requirements of this Directive, as amended by Directive 2001/43/EC.

<sup>(1)</sup> Directive 2001/43/EC of the European Parliament and of the Council of 17 June 2001 amending Council Directive 92/23/EEC relating to tyres for motor vehicles and their trailers and to their fitting (OJ L 211, 4.8.2001, p. 25).

**▼M1**

5. As from 1 October 2009, the provisions of this Directive, as amended by Directive 2001/43/EC, shall apply for the purposes of Article 7(2) of Directive 70/156/EC, to all tyres which fall within the scope of this Directive, with the exception of tyres of classes C1d and C1e, to which they shall apply as from 1 October 2010 and 1 October 2011 respectively.

**▼B***Article 11*

1. Member States shall adopt and publish the provisions necessary to comply with this Directive before 1 July 1992 and shall forthwith inform the Commission thereof.

When the Member States adopt these measures, they shall contain a reference to this Directive or shall be accompanied by such a reference on the occasion of their official publication. The methods of making such a reference shall be laid down by the Member States.

They shall apply these measures from 1 January 1993.

2. Member States shall communicate to the Commission the texts of the main provisions of national law which they adopt in the field covered by this Directive.

*Article 12*

This Directive is addressed to the Member States.

**▼B****LIST OF ANNEXES****▼M1**

ANNEX I	Administrative provisions for the EC type-approval of tyres
Appendix 1	Information document relating to EC type-approval for a type of tyre
Appendix 2	EC type-approval certificate (tyres)
Appendix 3	Information document relating to EC type-approval for a type of tyre relating to tyre/road noise emission
Appendix 4	EC type-approval certificate (tyre/road noise emission)
ANNEX II <sup>(1)</sup>	Requirements for tyres
Appendix 1	Explanatory figure
Appendix 2	List of symbols of load-capacity indices and corresponding maximum mass to be carried
Appendix 3	Arrangement of tyre markings
Appendix 4	Relationship between the pressure index and the units of pressure
Appendix 5	Measuring rim, outer diameter and section width of tyres of certain size designations
Appendix 6	Method of measuring tyre dimensions
Appendix 7	Load/speed test procedure
Appendix 8	Variation of load capacity index with speed; commercial-vehicle tyres radial and diagonal
ANNEX III	Administrative provisions for type-approval of vehicles with regard to the fitting of their tyres
Appendix 1	Information document for a vehicle
Appendix 2	EC type-approval certificate for a vehicle
ANNEX IV	Requirements for vehicles with regard to the fitting of their tyres
ANNEX V	Tyre/road noise emission
Appendix 1	Test method for tyre-road sound levels, coast-by method
Appendix 2	Test report
ANNEXE VI	Specifications for the test site

<sup>(1)</sup> The technical requirements for tyres are similar to those of Regulations Nos 30 and 54 of the UN Economic Commission for Europe (UN/ECE).

**▼M1***ANNEX I***ADMINISTRATIVE PROVISIONS FOR THE EC TYPE-APPROVAL OF TYRES**

1. APPLICATION FOR THE EC TYPE-APPROVAL OF A TYPE OF TYRE
  - 1.1. The application for EC type-approval for a type of tyre pursuant to Article 3(4) of Directive 70/156/EEC is to be submitted by the tyre manufacturer.
    - 1.1.1. The application for EC type-approval pursuant to Annex II is to be accompanied, in triplicate, by a description of the tyre type as described in the information document in Appendix 1.
      - 1.1.1.1. The application must be accompanied (all in triplicate) by a sketch, or a representative photograph, which identifies the tyre tread pattern and a sketch of the envelope of the inflated tyre mounted on the measuring rim showing the relevant dimensions (see sections 6.1.1. and 6.1.2. of Annex II) of the type submitted for approval.
      - 1.1.1.2. It must be accompanied either by the test report issued by the appointed technical service or by a number of samples to be determined by the approval authority.
    - 1.1.2. The application for EC type-approval pursuant to Annex V is to be accompanied, in triplicate, by a description of the tyre type as described in the information document in Appendix 3.
      - 1.1.2.1. The application must be accompanied (all in triplicate) by sketches, drawings or photographs of the tread pattern(s) that is/are representative of the type of tyres.
      - 1.1.2.2. It must also be accompanied either by the test report issued by the appointed technical service or by a number of samples to be determined by the approval authority.
  - 1.2. The manufacturer may apply for EC type-approval to be extended
    - 1.2.1. to include modified tyre types for EC type-approvals pursuant to Annex II and/or
    - 1.2.2. to include additional tyre size designations and/or amended brand names or manufacturer's trade descriptions and/or tread patterns for EC type-approvals pursuant to Annex V.

**▼M2**

- 1.3. The approval authority may accept the laboratories of the tyre manufacturers as approved test laboratories pursuant to Article 14(1) of Directive 70/156/EEC.

**▼M1**

2. INSCRIPTIONS
  - 2.1. Samples of a type of tyre submitted for EC type-approval must bear the applicant's clearly visible and indelible trade mark or name and must allow sufficient space for the inscription of the EC type-approval mark as required in section 4 of this Annex.
3. EC TYPE-APPROVAL
  - 3.1. EC type-approval pursuant to Article 4 of Directive 70/156/EEC is to be granted and an EC type-approval number is to be issued in respect of any tyre type, submitted in accordance with 1.1.1. above, which satisfies the requirements of Annex II.
    - 3.1.1. Notice of approval or extension or refusal or withdrawal of approval or of production definitively discontinued in relation to a tyre type pursuant to Annex II must be communicated to the Member States in accordance with Article 4(6) of Directive 70/156/EEC.
    - 3.1.2. EC type-approval pursuant to Article 4 of Directive 70/156/EEC is to be granted and an EC type-approval number is to be issued in respect of any tyre type, submitted in accordance with 1.1.2. above, which satisfies the requirements of Annex V.
  - 3.2.1. Notice of approval or extension or refusal or withdrawal of approval or of production definitively discontinued in relation to a tyre type pursuant to Annex V must be communicated to the Member States in accordance with Article 4(6) of Directive 70/156/EEC.



▼ **M1**

- 3.3. An EC type-approval number is to be assigned to each tyre type-approved. The same Member State must not assign the same number to another tyre type. In particular, approval numbers assigned pursuant to Annex II and EC type-approval numbers assigned pursuant to Annex V must be different.
4. EC TYPE-APPROVAL MARKING
- 4.1. Any tyre conforming to a type in respect of which EC type-approval has been granted pursuant to this Directive must bear the relevant EC type-approval mark.
- 4.2. The EC type-approval mark will consist of a rectangle surrounding the lower case letter 'e' followed by the distinguishing number of the Member State which has granted the type-approval as per Annex VII to Directive 70/156/EEC. The EC type-approval number will consist of the EC type-approval number shown on the certificate completed for the type, preceded by two figures: '00' for commercial vehicle tyres, '02' for passenger car tyres.
- 4.2.1. The rectangle forming the EC type-approval mark must have a minimum length of 12 mm and a minimum height of 8 mm. Letter(s) and number (s) must be at least 4 mm in height.
- 4.3. The EC type-approval marks and numbers, and any additional marks required in Annex II, section 3., the latter for the type-approval pursuant to the requirements of Annex II, must be affixed as prescribed in that section.
- 4.4. Approval numbers assigned pursuant to Annex V must be followed by the suffix 's' where 's' is an abbreviation for sound.
- 4.5. An example of the EC type-approval mark is given below:

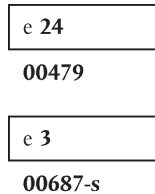

The tyre bearing the EC type-approval mark shown above is a commercial vehicle tyre (00) satisfying the EC requirements (e), for which the EC type-approval mark has been granted in Ireland (24) under the number 479 pursuant to Annex II and in Italy (3) under the number 687-s pursuant to Annex V.

*Note:* The numbers '479' and '687' (EC-mark type-approval numbers) and the number '24' and the digit '3' (letters and number of the Member States which granted the EC approval) are for guidance only.

The approval numbers must be placed close to the rectangle and may be above, below, to the left or to the right. The characters of the approval number must all be on the same side of the 'e' and face in the same direction.

5. MODIFICATION OF A TYRE TYPE
- 5.1. If a tyre type-approved pursuant to Annex II or pursuant to Annex V has been modified, the provisions of Article 5 of Directive 70/156/EEC shall apply.
- 5.2. If the tread pattern of a tyre has been modified in the case of type-approvals pursuant to Annex II, no repetition of the tests prescribed in Annex II is considered necessary.
- 5.3. In the case where tyre-size designations or trade marks are added to a range of tyres type-approved pursuant to Annex V, any requirement for retesting shall be determined by the type approval authority.
- 5.4. In the case of modification of the tyre tread pattern of a range of tyres approved pursuant to Annex V, a representative set of samples shall be retested unless the type approval authority is satisfied that the modification does not affect the tyre/road noise emissions.

**▼M1**

## 6. CONFORMITY OF PRODUCTION

- 6.1. The general rules to ensure the conformity of production shall be adopted in accordance with the provisions laid down in Article 10 of Directive 70/156/EEC.
- 6.2. In particular, when checks are carried out in accordance with Appendix 1 to Annex V in order to check the conformity of production, if the noise level of the tyre tested does not exceed the limit values set out in section 4.2. of Annex V by more than 1 dB(A), the production shall be deemed to conform to the requirements of section 4 of the abovementioned Annex V.

▼ M1*Appendix 1***INFORMATION DOCUMENT No ... RELATING TO EC TYPE-APPROVAL FOR A TYPE OF TYRE**

(Annex II to Directive 92/23/EEC)

▼ B

The following information, if applicable, must be supplied in triplicate and include a list of contents. Drawings, if any, must be supplied in appropriate scale and in sufficient detail on size A4 or folded to that size. In the case of microprocessor controlled functions supply relevant performance-related information.

0. GENERAL
- 0.1. Make (trade name of manufacturer): .....
- 0.2. Commercial description(s): .....
- 0.3. Means of identification (tyre-size designation): .....
- 0.5. Name and address of applicant: .....
- 0.7. Address(es) of manufacturing plant(s): .....
6. TYRES
- 6.1. The category of use: .....
- 6.2. The structure: .....
- 6.3. The speed category: .....
- 6.4. The load-capacity index (indices):  
 — single formation: .....
- dual (twin) formation: .....
- 6.5. Whether the tyre is to be fitted with or without an inner tube: .....
- 6.7. Whether the tyre is: .....
- 6.7.1. Passenger car 'standard' or 'reinforced' or 'T-type temporary use spare' tyre: .....
- 6.7.2. Commercial vehicle ' regroovable ' tyre: .....
- 6.8. The ply-rating number (if applicable) of diagonal (bias-ply) tyres: .....
- 6.9. The overall dimensions: overall section width and outer diameter: .....
- 6.10. The rim(s) on which the tyre can be mounted: .....
- 6.11. The measuring rim and test rim: .....
- 6.12. The measuring pressure (bar): .....
- 6.13. The additional load/speed combinations in cases where section 6.2.5 of Annex II is applied: .....
- .....
- 6.14. The test pressure where the manufacturer requests the application of section 1.3 of Appendix 7, Part A of Annex II or the 'PSI' pressure index: .....
- 6.15. The factor x referred to in section 2.20 of Annex II or the applicable table of Appendix 5 to Annex II: .....
- .....

▼ **M1**

## Appendix 2

**EC TYPE-APPROVAL CERTIFICATE**

(tyres)

MODEL

(maximum format: A4 (210 mm × 297 mm))

▼ **B**

<b>STAMP OF ADMINISTRATION</b>
------------------------------------

Communication concerning the:

- type-approval <sup>(1)</sup>
- extension of type-approval <sup>(1)</sup>
- refusal of type-approval <sup>(1)</sup>
- ▶<sup>(2)</sup> — withdrawal of type-approval <sup>(1)</sup>
- discontinuation of production <sup>(1)</sup> ◀

of a component with regard to Directive 92/23/EEC relating to tyres.

<sup>(1)</sup> EC type-approval ◀ No: ..... Extension No: .....

## SECTION I

## 0. General

- 0.1. Make (trade name of manufacturer): .....
- 0.2. Commercial description(s): .....
- 0.3. Means of identification marked on the component (tyre) <sup>(a)</sup>: .....
- 0.4. List of applicable annexes: .....
- 0.5. Name and address of applicant: .....
- 0.6. Address(es) of manufacturing plant(s): .....

<sup>(1)</sup> Delete where inapplicable.

(a) The means of identification of type, if used, must appear only on those tyres covered by the individual approval.

If the means of identification of type contains characters not relevant to describe the tyre types covered by this component type-approval certificate (e.g. a date code) such characters must be represented in the documentation by the symbol:

"?" (e.g. ABC ?? 123 ??)

- the size designation,
- the category of use,
- the load capacity index,
- the speed category,
- whether or not the tyre may be used tubeless,
- whether or not the tyre is 'reinforced' or 'T-type temporary use spare tyre' in the case of passenger car tyres,
- whether or not the tyre is 'regroovable' in the case of commercial vehicle tyres,
- additional load capacity index/indices and speed category symbol.

▶ (1) (2) (3) (4) **M1**

▼B

## SECTION II

1. **Additional information**
- 1.1. The list of rims on which the tyres may be fitted: .....
2. Technical service responsible for carrying out the tests: .....
3. Date of test report: .....
4. Number of test report: .....
5. Grounds for extending component type-approval (where appropriate): .....  
.....
6. Comments (if any): .....
7. Place: .....
8. Date: .....
9. Signature: .....
10. A list of documents making up the type-approval file lodged with the authority that has granted the component approval and which may be obtained on request, is attached.

▼ **M1**

## Appendix 3

**INFORMATION DOCUMENT No ... RELATING TO EC TYPE-APPROVAL FOR A TYPE OF TYRE RELATING TO TYRE/ROAD NOISE EMISSION**

(Annex V to Directive 92/23/EEC)

The following information, if applicable, must be supplied in triplicate and include a list of contents. Drawings, if any, must be supplied to an appropriate scale and in sufficient detail on size A4 or folded to that size. Relevant performance-related information must be supplied in the case of microprocessor controlled functions.

**1. GENERAL**

1.1. Manufacturer's name:

1.2. Name and address of applicant:

1.3. Address(es) of manufacturing plant(s):

1.4. Brand name(s), Trade description(s) or Trade mark(s) to be used for particular tyre type-approval requested.

**2. TYRES**

2.1. Tyre classification: (class C1, class C2 or class C3)

2.2. Category of use: (normal, snow or special)

2.3. Details of the major features, with respect to the effects on tyre/road noise emission, of the tread pattern(s) to be used on the designated range of tyre sizes. This may be by drawing, photograph or description but must be sufficient to allow the type approval authority or technical service to determine whether any subsequent changes to the major features will adversely affect the tyre/road noise emission.

*Note:* The effect of changes in minor details of tyre tread and construction on the tyre/road noise emission will be determined during checks on the conformity of production.

2.4 Tyre structure

2.5. List of tread-pattern designations:

(specify for each trade mark or brand name and trade description the list of tyre designations as per section 2.17. of Annex II to Directive 92/23/EEC adding, in the case of class C1 tyres, the mark 'Reinforced' or 'Extra Load', if applicable).

▼ **M1***Appendix 4***EC TYPE-APPROVAL CERTIFICATE  
(tyre/road noise emission)**

## MODEL

(maximum format: A4 (210 mm × 297 mm))

Stamp of administration

Communication concerning the:

- EC type-approval <sup>(1)</sup>
- extension of EC type-approval <sup>(1)</sup>
- refusal of EC type-approval <sup>(1)</sup>
- withdrawal of EC type-approval <sup>(1)</sup>
- discontinuation of production <sup>(1)</sup>

of a type of tyre with regard to Annex V to Directive 92/23/EEC, as last amended by Directive .../.../EC, relating to tyre/road noise emission.

EC type-approval No: ..... Extension No: .....

## SECTION I

**0. General**

- 0.1. Manufacturer's name:
- 0.2. Name and address of applicant:
- 0.3. Address(es) of manufacturing plant(s):

## SECTION II

**1. Additional information**

- 1.1. Brand name(s) and trade description(s):
- 1.2. Tyre classification: (class C1, class C2 or class C3) <sup>(1)</sup>
- 1.3. Category of use: (Normal/Snow/Special) <sup>(1)</sup>
- 2. Technical Service responsible for carrying out tests:
- 3. Date of test report:
- 4. Number of test report:
- 5. Grounds for extending EC type-approval (where appropriate):
- 6. Comments (if any):
- 7. Date and place:
- 8. Signature:
- 9. A list of documents making up the EC type-approval file lodged with the authority that has granted the approval and which may be obtained on request is attached.

<sup>(1)</sup> Delete as appropriate.



ANNEX II

REQUIREMENTS FOR TYRES

1. DEFINITIONS
2. For the purposes of this Directive:
  - 2.1. 'type of tyre' means a category of tyres which do not differ in such essential respects as:
    - 2.1.1. manufacturer's name or trade mark;
    - 2.1.2. tyre-size designation;
    - 2.1.3. category of use:
      - normal: normal road-use tyre,
      - special: special-use tyre, e.g. tyre for mixed use (both on and off the road) and at restricted speed,
      - snow tyre,
      - temporary-use spare tyre;
    - 2.1.4. structure (diagonal (bias-ply), bias-belted, radial-ply);
    - 2.1.5. speed category;
    - 2.1.6. load capacity index;
    - 2.1.7. tyre cross-section;
  - 2.2. 'snow tyre' means a tyre the tread pattern and structure of which are primarily designed to ensure in mud and fresh or melting snow a performance better than that of a normal tyre. The tread pattern of a snow tyre generally consists of groove (rib) and/or solid-block elements more widely spaced than on a normal tyre;
  - 2.3. 'structure' of a tyre means the technical characteristics of the tyre's carcass. The following structures are distinguished in particular:
    - 2.3.1. 'diagonal' or 'bias-ply' describes a tyre structure in which the ply cords extend to the bead and are laid at alternate angles of substantially less than 90° to the centreline of the tread;
    - 2.3.2. 'bias-belted' describes a tyre structure of diagonal (bias-ply) type in which the carcass is restricted by a belt comprising two or more layers of substantially inextensible cord material laid at alternate angles close to those of the carcass;
    - 2.3.3. 'radial' describes a tyre structure in which the ply cords extend to the beads and are laid substantially at 90° to the centreline of the tread, the carcass being stabilized by an essentially inextensible circumferential belt;
    - 2.3.4. 'reinforce' describes a tyre structure in which the carcass is more resistant than that of the corresponding standard tyre;
    - 2.3.5. 'temporary-use spare tyre' means a tyre different from a tyre intended to be fitted to any vehicle for normal driving conditions; but intended only for temporary use under restricted driving conditions;
    - 2.3.6. 'T-type temporary-use spare tyre' means a type of temporary-use spare tyre designed for use at inflation pressure higher than those established for standard and reinforced tyres;
  - 2.4. 'bead' means the part of a tyre which is of such shape and structure as to fit the rim and hold the tyre on it <sup>(1)</sup>;
  - 2.5. 'cord' means the strands forming the fabric of the plies in the tyre <sup>(1)</sup>;
  - 2.6. 'ply' means a layer of rubber-coated parallel cords <sup>(1)</sup>;

<sup>(1)</sup> See explanatory figure, Appendix 1.



▼B

- 2.7. *'carcass'* means that part of a tyre other than the tread and the rubber sidewalls which, when inflated, bears the load <sup>(1)</sup>;
- 2.8. *'tread'* means that part of a tyre which comes into contact with the ground <sup>(1)</sup>;
- 2.9. *'sidewall'* means the part of the tyre, excluding the tread, which is visible when the tyre, fitted to a rim, is viewed from the side <sup>(1)</sup>;
- 2.10. *'lower sidewall'* means the area below the line of maximum section width of the tyre, which is visible when the tyre, fitted to a rim, is viewed from the side <sup>(1)</sup>;
- 2.11. *'tread groove'* means the space between the adjacent ribs or blocks in the tread pattern <sup>(1)</sup>;
- 2.12. *'section width'* means the linear distance between the outsides of the sidewalls of an inflated tyre, excluding elevations due to labelling (marking), decoration or protective bands or ribs <sup>(1)</sup>;
- 2.13. *'overall width'* means the linear distance between the outsides of the sidewalls of an inflated tyre, including labelling (marking), decoration and protective bands or ribs <sup>(1)</sup>;
- 2.14. *'section height'* means a distance equal to half the difference between the outer diameter of the tyre and the nominal rim diameter <sup>(1)</sup>;
- 2.15. *'nominal aspect ratio Ra'* means one hundred times the number obtained by dividing the number expressing the nominal section height in millimetres by the number expressing the nominal section width in millimeters;
- 2.16. *'outer diameter'* means the overall diameter of an inflated new tyre <sup>(1)</sup>;
- 2.17. *'tyre-size designation'*:
- 2.17.1. means a designation showing:
- 2.17.1.1. the nominal section width. This width must be expressed in mm, except in the case of tyres for which the size designation is shown in the first column of the tables in Appendix 5;
- 2.17.1.2. the nominal aspect ratio, except in the case of tyres for which the size designation is shown in the first column of the tables in Appendix 5;
- 2.17.1.3. a conventional number 'd' (the 'd' symbol) denoting the nominal rim diameter and corresponding to the diameter of the rim expressed either in inches (number below 100 — see table) or in mm (numbers above 100) but not both.

The exhaustive range of values is shown in the table below:

'd'Nominal rim diameter (the symbol)	
Expressed in inches (code)	Equivalence in mm (reference section 6.1.2.1)
10	254
11	279
12	305
13	330
14	356
15	381
16	406
17	432
18	457
19	483
20	508
21	533
22	559

<sup>(1)</sup> See explanatory figure, Appendix 1.

## ▼B

‘d’Nominal rim diameter (the symbol)	
Expressed in inches (code)	Equivalence in mm (reference section 6.1.2.1)
24	610
25	635
14,5	368
16,5	419
17,5	445
19,5	495
20,5	521
22,5	572
24,5	622

- 2.17.1.4. the letter ‘T’ in front of the nominal section width in case of T-type temporary-use spare tyres;
- 2.18. *‘nominal rim diameter (d)’* means the diameter of the rim on which a tyre is designed to be mounted <sup>(1)</sup>;
- 2.19. *‘rim’* means the support for a tyre-and-tube assembly, or for a tubeless tyre, on which the tyre beads are seated <sup>(1)</sup>;
- 2.20. *‘theoretical rim’* means the notional rim whose width would be equal to x times the nominal section width of a tyre; the value ‘x’ must be specified by the tyre manufacturer;
- 2.21. *‘measuring rim’* means the rim on which a tyre must be fitted for size measurements;
- 2.22. *‘test rim’* means the rim on which a tyre must be fitted for testing;
- 2.23. *‘chunking’* means the breaking away of pieces of rubber from the tread;
- 2.24. *‘cord separation’* means the parting of the cords from their rubber coating;
- 2.25. *‘ply separation’* means the parting of adjacent plies;
- 2.26. *‘tread separation’* means the pulling away of the tread from the carcass;
- 2.27. *‘tread-wear indicators’* mean projections within the tread-grooves designed to give a visual indication of the degree of wear of the tread;
- 2.28. *‘load-capacity index’* means one or two numbers which indicate the load the tyre can carry in single or in single and dual formation at the speed corresponding to the associated speed category and when operated in conformity with the requirements governing utilization specified by the manufacturer. The list of these indices and their corresponding masses is given in Annex II, Appendix 2;
- 2.28.1. on passenger car tyres there must be one load index only;
- 2.28.2. on commercial vehicle tyres there may be one or two load indices, the first one for single formation and the second one, when present, for dual (twin) formation in which case the two indices are divided by a slash (/);
- 2.28.3. a type of tyre may have either one or two sets of load capacity indices depending on whether or not the provisions of section 6.2.5 are applied;
- 2.29. *‘speed category’*, expressed by the speed category symbol as shown in the table in 2.29.3;
- 2.29.1. in the case of a passenger car tyre, the maximum speed which the tyre can sustain;
- 2.29.2. in the case of a commercial vehicle tyre, the speed at which the tyre can carry the mass corresponding to the load capacity index;

<sup>(1)</sup> See explanatory figure, Appendix 1.

▼B

2.29.3. The speed categories are as shown in the table below:

Speed category symbol	Corresponding speed (km/h)
F	80
G	90
J	100
K	110
L	120
M	130
N	140
P	150
Q	160
R	170
S	180
T	190
U	200
H	210
V	240

2.29.4. tyres suitable for maximum speeds higher than 240 km/h are identified by means of the letter code 'Z' placed within the tyre size designation;

2.29.5. a type of tyre may have either one or two sets of speed category symbols depending on whether or not the provisions of section 6.2.5 are applied;

2.30. *'table: Variation of load capacity with speed'* means: the table, in Annex II Appendix 8, showing as a function of the load capacity indices and nominal speed category symbols the load variations which a tyre can withstand when used at speeds different from that corresponding to its speed category symbol;

2.30.1. the load variations do not apply in the case of passenger car tyres nor, in the case of commercial vehicle tyres, to the additional load capacity indices and speed category symbol when the provisions of section 6.2.5 are applied;

2.31. *'maximum load rating'* means the maximum mass the tyre is rated to carry:

2.31.1. in the case of passenger car tyres suitable for speeds not exceeding 210 km/h, the maximum load rating must not exceed the value associated with the load capacity index of the tyre;

2.31.2. in the case of passenger car tyres suitable for speeds exceeding 210 km/h, but not exceeding 240 km/h (tyres classified with speed category symbol 'V'), the maximum load rating must not exceed the percentage of the value associated with the load capacity index of the tyre, indicated in the table below, with reference to the speed capability of the vehicle to which the tyre is fitted;

Maximum speed (km/h)	Load (%)
215	98,5
220	97
225	95,5
230	94
235	92,5
240	91

for intermediate maximum speeds linear interpolations of the maximum load rating are allowed;

2.31.3. for speeds exceeding 240 km/h ('Z tyres') the maximum load rating must not exceed the value specified by the tyre manufacturer with

## ▼B

- reference to the maximum speed capability of the vehicle to which it is fitted;
- 2.31.4. in the case of commercial vehicle tyres, the maximum load rating, both for single and for dual formation, must not exceed the percentage of the value associated with the relevant load capacity index of the tyre as indicated in the table 'Load-capacity variation with speed' (see 2.30), with reference to the speed category symbol of the tyre and the speed capability of the vehicle to which the tyre is fitted. When additional load capacity indices and speed category symbols apply, those too are considered to determine the maximum load rating of the tyre;
- 2.32. '*passenger car tyre*' means a tyre designed primarily, but not only, for passenger cars (motor vehicles in category M1) and their trailers (01 and 02);
- 2.33. '*commercial vehicle tyre*' means a tyre designed primarily, but not only, for vehicles other than passenger cars (motor vehicles in categories M2, M3, N) and their trailers (03, 04);
- 2.34. '*tyre ground pressure (F/Ac)*' means the average until load transmitted by the tyre, through its contact area, to the road surface expressed as the ratio between the vertical force (F), in static conditions on the axis of the wheel and the tyre contact area (Ac) measured with the tyre inflated at the cold inflation pressure recommended for the intended type of service. It is expressed in kN/m<sup>2</sup>;
- 2.35. '*tyre contact area (Ac)*' means the area of the flat surface contained within the virtual perimeter of the tyre footprint. It is expressed in m<sup>2</sup>;
- 2.36. '*virtual perimeter of the tyre footprint*' means the convex polygonal curve circumscribing the smallest area containing all points of contact between the tyre and the ground;
- 2.37. '*cold inflation pressure*' means the internal pressure of the tyre with the tyre at ambient temperature and does not include any pressure build up due to tyre usage. It is expressed in bar kPa.

## 3. MARKING REQUIREMENTS

- 3.1. Tyres must bear:
- 3.1.1. the manufacturer's name or trade mark;
- 3.1.2. the tyre-size designation as defined in section 2.17;
- 3.1.3. an indication of the structure as follows:
- 3.1.3.1. on diagonal (bias-ply) tyres, no marking or the letter 'D';
- 3.1.3.2. on radial-ply tyres, the letter 'R' placed in front of the nominal diameter marking and, optionally, the word 'RADIAL';
- 3.1.3.3. on bias-belted tyres, the letter 'B' placed in front of the nominal rim diameter marking and, in addition, the words 'BIAS-BELTED';
- 3.1.4. an indication of the tyre's speed category by means of the symbol shown in section 2.29; in the case of tyres suitable for speeds higher than 240 km/h the speed category of the tyre must be indicated by the letter code 'Z' placed in front of the indication of the structure (see section 3.1.3);
- 3.1.5. the inscription 'M + S' (for alternatively 'M.S.' or 'M & S') in the case of a snow tyre;
- 3.1.6. the load-capacity index as defined in section 2.28;
- 3.1.6.1. however, in the case of tyres suitable for speeds higher than 240 km/h the indication of the load capacity index may be omitted;
- 3.1.7. the word 'TUBELESS' if the tyre is designed for use without an inner tube;
- 3.1.8. the word 'REINFORCED' if the tyre is a reinforced tyre;
- 3.1.9. the date of manufacture in the form of a group of three digits, the first two showing the week and the last one the year of manufacture;
- 3.1.10. in the case of commercial vehicle tyres which can be regrooved, the symbol '♻' at last 20 mm in diameter, or the word 'REGROOVABLE', moulded into or on to each sidewall;

▼B

- 3.1.11. in the case of commercial vehicles tyres, an indication, by the 'PSI' index (see Appendix 4), of the inflation pressure to be adopted for the load/speed tests, as explained in Appendix 7 Part B;
- 3.1.12. the additional load capacity index/indices and the speed category symbol in the case where the provisions of section 6.2.5 are applied.
- 3.2. Appendix 3 gives examples of the arrangement of tyre markings.
- 3.3. The tyre must also bear the ►**M1** EC type-approval ◀ mark, the model of which is given in Annex I, section 4.5.

## POSITION OF MARKINGS

- 3.4. The markings referred to in section 3.1 and 3.3 must be clearly and legibly moulded into or on to both sidewalls, and at least on one side on the lower sidewall, as follows:
- 3.4.1. in the case of symmetrical tyres, all the markings referred to above must be located on both sidewalls except the markings referred to in sections 3.1.9, 3.1.11 and 3.3 which may be on one sidewall only;
- 3.4.2. in the case of asymmetrical tyres all the markings must be located on at least the outer sidewall.

(4.)

(5.)

(6.)

6.1. **Dimensional requirements**6.1.1. *Section width of a tyre*

- 6.1.1.1. Except as provided by section 6.1.1.2, the section width is calculated by the following formula:

$$S = S_1 + K (A - A_1),$$

where:

S = the 'section width' expressed in mm <sup>(1)</sup> and measured on the measuring rim;

S<sub>1</sub> = the 'nominal section width' in mm as shown on the sidewall of the tyre in the tyre-size designation as prescribed;

A = the width (expressed in mm) of the measuring rim, as shown by the manufacturer in the descriptive note, (see section 6.11 of Annex I, Appendix 1);

A<sub>1</sub> = the width (expressed in mm) of the theoretical rim; it is taken to equal S<sub>1</sub> multiplied by the factor x as specified by the tyre manufacturer (see section 6.15 of Annex I, Appendix 1); and K is taken to equal 0.4.

- 6.1.1.2. However, for the types of tyre for which the size designation is given in the first column of the tables in Appendix 5 A or 5 B, the measuring rim width (A) and the section width (S) are those given opposite the tyre size designation in those tables.

6.1.2. *Outer diameter of a tyre*

- 6.1.2.1. Except as provided by section 6.1.2.2, the outer diameter of a tyre is calculated by the following formula:

$$D = d + 0,02H$$

where:

— D is the outer diameter expressed in mm,

— d is the conventional number defined in section 2.17.1.3, expressed in mm,

— H is the nominal section height in mm and is equal to S<sub>1</sub> × 0,01 Ra;

where:

— Ra is the nominal aspect ratio,

(<sup>1</sup>) Equivalence factor from inches to mm is 25,4.

## ▼B

all as shown on the sidewall of the tyre in the tyre-size designation in conformity with the requirements of section 3.

6.1.2.2. However, for the types of tyres for which the size designation is given in the first column of the tables of Appendix 5 the outer diameter is that given opposite the tyre size designation in those tables.

6.1.3. *Method of measuring tyre dimensions*

The actual dimensions of tyres are measured as prescribed in Appendix 6.

6.1.4. *Tyre section width: specification of tolerance*

6.1.4.1. The overall width of a tyre may be less than the section width determined pursuant to section 6.1.1 or shown in Appendix 5;

6.1.4.2. It may not exceed that value by more than the following:

6.1.4.2.1. diagonal (bias-ply) tyres: 6 % for passenger car tyres, 8 % for commercial vehicle tyres;

6.1.4.2.2. radial-ply tyres: 4 %; and

6.1.4.2.3. in addition, if the tyre has a special protective band, the figure as increased by the above tolerances may be exceeded by 8 mm.

6.1.4.2.4. However, for tyres of a section width exceeding 305 mm intended for dual (twin) mounting the nominal value must not be exceeded by more than 2 % for radial-ply or 4 % for diagonal (bias-ply) tyres.

6.1.5. *Tyre outer diameter: specification of tolerance*

The outer diameter of a tyre must not be outside the values  $D_{min}$  and  $D_{max}$  obtained from the following formulae:

$$D_{min} = d + (2H \times a)$$

$$D_{max} = d + (2H \times b)$$

6.1.5.1. for sizes listed in Appendix 5:

$$H = 0,5 (D - d) \text{ — (for references see section 6.1.2.2).}$$

6.1.5.2. for other sizes not listed in Appendix 5:

'H' and 'd' are as defined in section 6.1.2.1.

6.1.5.3. coefficients 'a' and 'b' are respectively:

6.1.5.3.1. coefficient 'a' = 0,97;

6.1.5.3.2. coefficient 'b' for normal, special, snow or temporary-use spare tyres

Category of use	Passenger car tyres		Commercial vehicle tyres	
	Radial	Bias	Radial	Bias
Normal	1,04	1,08	1,04	1,07
Special	—	—	1,06	1,09
Snow	1,04	1,08	1,04	1,07
Temporary-use	1,04	1,08	—	—

6.1.5.4. For snow tyres the outer diameter ( $D_{max}$ ) established in conformity with the above may be exceeded by 1 %.

6.2. *Load/speed test requirement*

6.2.1. The tyre must undergo a load/speed test carried out in accordance with the relevant procedure described in Appendix 7.

6.2.2. A tyre which, after undergoing the relevant load/speed test, does not exhibit any tread separation, ply separation, cord separation, chunking or broken cords is deemed to have passed the test.

6.2.3. The outer diameter of the tyre, measured six hours after the load/speed test, must not be more than 3,5 % greater than the outer diameter as measured before the test.

6.2.4. Where application is made for the approval of a type of commercial vehicle tyre the load/speed combinations given in the table in Appendix 8 apply and, the load/speed test prescribed in section 6.2.1 need not be carried out for load and speed values other than the nominal values.

**▼B**

- 6.2.5. Where application (see section 6.13 of Annex 1, Appendix 1) is made for the type-approval of a type of commercial vehicle tyre which has a load/speed combination in addition to the one that is subject to the variation of load with speed given in the table in Appendix 8, the load/speed test prescribed in section 6.2.1 must also be carried out on a second tyre of the same type at the additional load/speed combination.
- 6.2.6. Where a tyre manufacturer produces a range of tyres it is not considered necessary to carry out a load/speed test on every type of tyre in the range. Worst-case selection may be made, at the discretion of the approval authority.
- 6.3. **Tread-wear indicators**
- 6.3.1. In the case of passenger car tyres the tread of the tyre must include not less than six transverse rows of tread-wear indicators, approximately equally spaced and situated in the wide grooves in the central zone of the tread, which covers approximately three quarters of the tread width. The tread-wear indicators must be such that they cannot be confused with the rubber ridges between the ribs or blocks of the tread.
- 6.3.2. However, in the case of tyres of dimensions appropriate for mounting on rims of a nominal diameter of 12" or less, four rows of tread-wear indicators are acceptable.
- 6.3.3. The tread-wear indicators must give visual warning when the depth of the corresponding tread grooves has been reduced to 1,6 mm with a tolerance of + 0,6/- 0 mm.

▼B

Appendix 1

Explanatory figure

(see Annex II, sections 2 and 6.1)

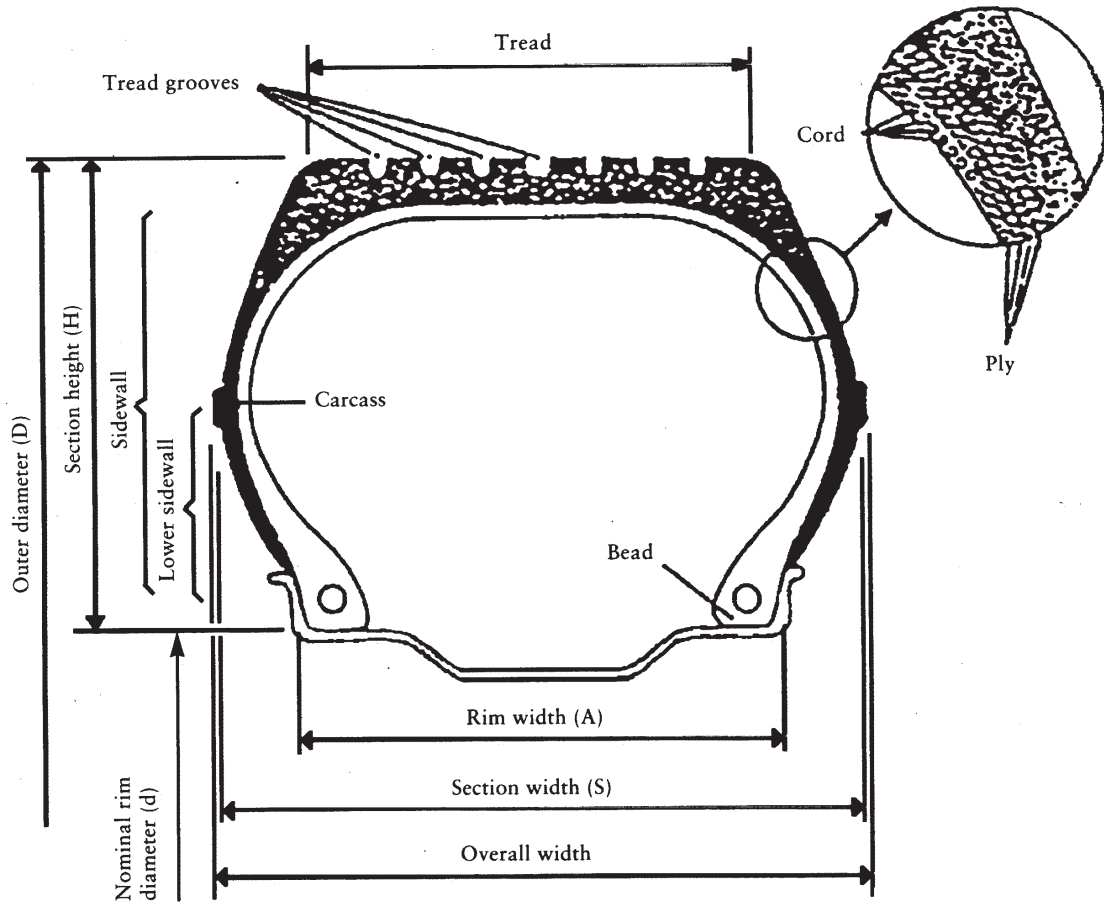



▼B*Appendix 2***LIST OF SYMBOLS OF LOAD-CAPACITY INDICES (LI) AND CORRESPONDING MAXIMUM MASS TO BE CARRIED (GK)**

(see Annex II, section 2.28)

LI	Maximum
0	45
1	46,2
2	47,5
3	48,7
4	50
5	51,5
6	53
7	54,5
8	56
9	58
10	60
11	61,5
12	63
13	65
14	67
15	69
16	71
17	73
18	75
19	77,5
20	80
21	82,5
22	85
23	87,5
24	90
25	92,5
26	95
27	97,5
28	100
29	103
30	106
31	109
32	112
33	115
34	118
35	121
36	125
37	128
38	132
39	136
40	140
41	145
42	150

**▼B**

LI	Maximum
43	155
44	160
45	165
46	170
47	175
48	180
49	185
50	190
51	195
52	200
53	206
54	212
55	218
56	224
57	230
58	236
59	240
60	250
61	257
62	265
63	272
64	280
65	290
66	300
67	307
68	315
69	325
70	335
71	345
72	355
73	365
74	375
75	387
76	400
77	412
78	425
79	437
80	450
81	462
82	475
83	487
84	500
85	515
86	530
87	545
88	560
89	580
90	600

**▼B**

LI	Maximum
91	615
92	630
93	650
94	670
95	690
96	710
97	730
98	750
99	775
100	800
101	825
102	850
103	875
104	900
105	925
106	950
107	975
108	1 000
109	1 030
110	1 060
111	1 090
112	1 120
113	1 150
114	1 180
115	1 215
116	1 250
117	1 285
118	1 320
119	1 360
120	1 400
121	1 450
122	1 500
123	1 550
124	1 600
125	1 650
126	1 700
127	1 750
128	1 800
129	1 850
130	1 900
131	1 950
132	2 000
133	2 060
134	2 120
135	2 180
136	2 240
137	2 300
138	2 360

**▼B**

LI	Maximum
139	2 430
140	2 500
141	2 575
142	2 650
143	2 725
144	2 800
145	2 900
146	3 000
147	3 075
148	3 150
149	3 250
150	3 350
151	3 450
152	3 550
153	3 650
154	3 750
155	3 875
156	4 000
157	4 125
158	4 250
159	4 375
160	4 500
161	4 625
162	4 750
163	4 875
164	5 000
165	5 150
166	5 300
167	5 450
168	5 600
169	5 800
170	6 000
171	6 150
172	6 300
173	6 500
174	6 700
175	6 900
176	7 100
177	7 300
178	7 500
179	7 750
180	8 000
181	8 250
182	8 500
183	8 750
184	9 000
185	9 250
186	9 500

**▼B**

LI	Maximum
187	9 750
188	10 000
189	10 300
190	10 600
191	10 900
192	11 200
193	11 500
194	11 800
195	12 150
196	12 500
197	12 850
198	13 200
199	13 600
200	14 000

## ▼B

## Appendix 3

## ARRANGEMENT OF TYRE MARKINGS

(see Annex II, section 3.2)

## PART A: PASSENGER CAR TYRES

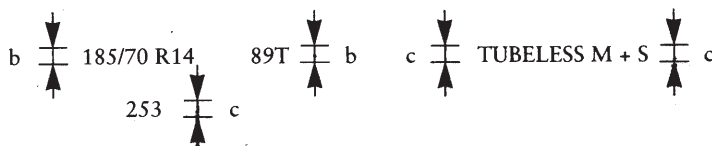

$b \geq 6 \text{ mm}$   
 $c \geq 4 \text{ mm}$

**Example of the markings to be borne by types of tyres placed on the market after notification of this Directive**

These markings define a tyre:

- having a nominal section width of 185,
- having a nominal aspect ratio of 70,
- of radial-ply structure (R),
- having a nominal rim diameter of 14,
- having a load capacity of 580 kg, corresponding to load index 89 in Appendix 2,
- classified in the speed category T (maximum speed 190 km/h),
- for fitting without an inner tube ('tubeless'),
- of 'snow' type,
- manufactured during the twenty-fifth week of the year 1993.

The positioning and order of the markings constituting the tyre designation are as follows:

- (a) the size designation, comprising the nominal section width, the nominal aspect ratio, the type of structure symbol (where applicable) and the nominal rim diameter, must be grouped as shown in the above example: 185/70 R 14;
- (b) the load index and the speed category symbol are placed near the size designation. They may either precede or follow it or be placed above or below it;
- (c) the symbols 'tubeless', 'reinforced', and 'M + S' may be at a distance from the size designation.

▼ B

## PART B: COMMERCIAL VEHICLE TYRES

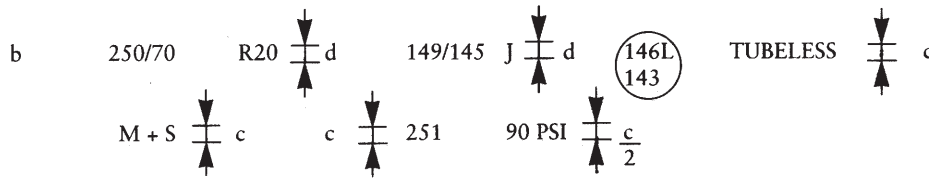

MINIMUM HEIGHTS OF MARKINGS (mm)		
	Tyres of rim diameter < 20" or < 508 mm or of section width ≤ 235 mm or ≤ 9"	Tyres of rim diameter ≥ 20" or ≥ 508 mm or of section width > 235 mm or > 9"
b	6	9
c	4	
d	6	

These markings define a tyre:

- having a nominal section width of 250,
- having a nominal aspect ratio of 70,
- of racial-ply structure (R),
- having a nominal rim diameter of 508 mm, for which the symbol is 20,
- having load capacities of 3 250 kg when single and 2 900 kg when twinned (dual), corresponding respectively to the load capacity indices 149 and 145 shown in Appendix 2,
- classified in the nominal speed category J (reference speed 100 km/h),
- able to be used additionally in speed category L (reference speed 120 km/h) with a load capacity of 3 000 kg when single and 2 725 kg when twinned (dual), corresponding respectively to the load capacity indices 146 and 143 shown in Appendix 2,
- for fitting without an inner tube 'tubeless',
- of 'snow' type,
- manufactured during the twenty-fifth week of the year 1991, and
- requiring to be inflated to 620 kPa for load/speed endurance tests, for which the PSI symbol is 90.

The positioning and order of the markings constituting the tyre designation are as follows:

- (a) the size designation, comprising the nominal section width, the nominal aspect ratio, the type-of-structure symbol (where applicable) and the nominal rim diameter, must be grouped as shown in the above example: 250/70 R 20;
- (b) the load indices and the speed category symbol are placed together near the size designation. They may either precede or follow it or be placed above or below it;
- (c) the symbols 'Tubeless', 'M + S' and 'REGROOVABLE' may be at a distance from the size designation;
- (d) if section 6.2.5 of Annex II is applied the additional load-capacity indices and speed-category symbol must be shown inside a circle near the nominal load-capacity indices and speed category symbol appearing on the tyre sidewall.

**▼B***Appendix 4***RELATIONSHIP BETWEEN THE PRESSURE INDEX AND THE UNITS OF PRESSURE**

(see Annex II, Appendix 7, Part B, section 1.3)

Pressure Index (‘PSI’)	bar	kPa
20	1.4	140
25	1.7	170
30	2.1	210
35	2.4	240
40	2.8	280
45	3.1	310
50	3.4	340
55	3.8	380
60	4.2	420
65	4.5	450
70	4.8	480
75	5.2	520
80	5.5	550
85	5.9	590
90	6.2	620
95	6.6	660
100	6.9	690
105	7.2	720
110	7.6	760
115	7.9	790
120	8.3	830
125	8.6	860
130	9.0	900
135	9.3	930
140	9.7	970
145	10.0	1 000
150	10.3	1 030





## Appendix 5

**MEASURING RIM, OUTER DIAMETER AND SECTION WIDTH OF TYRES OF CERTAIN SIZE DESIGNATIONS**

(see Annex II, sections 6.1.1.2 and 6.1.2.2)

## PART A: PASSENGER CAR TYRES

**TABLE 1****Tyres in diagonal construction**

Tyre size designation	Measuring rim width (inches)	Outer diameter <sup>(1)</sup> (in mm)	Section width <sup>(1)</sup> (in mm)
<i>Super balloon series</i>			
4.80-10	3.5	490	128
5.20-10	3.5	508	132
5.20-12	3.5	558	132
5.60-13	4	600	145
5.90-13	4	616	150
6.40-13	4.5	642	163
5.20-14	3.5	612	132
5.60-14	4	626	145
5.90-14	4	642	150
6.40-14	4.5	666	163
5.60-15	4	650	145
5.90-15	4	668	150
6.40-15	4.5	692	163
6.70-15	4.5	710	170
7.10-15	5	724	180
7.60-15	5.5	742	193
8.20-15	6	760	213
<i>Low section series</i>			
5.50-12	4	552	142
6.00-12	4.5	574	156
7.00-13	5	644	178
7.00-14	5	668	178
7.50-14	5.5	688	190
8.00-14	6	702	203
6.00-15 L	4.5	650	156
<i>Super low section series <sup>(2)</sup></i>			
155-13/6.15-13	4.5	582	157
165-13/6.45-13	4.5	600	167
175-13/6.95-13	5	610	178
155-14/6.15-14	4.5	608	157
165-14/6.45-14	4.5	626	167
175-14/6.95-14	5	638	178
185-14/7.35-14	5.5	654	188
195-14/7.75-14	5.5	670	198
<i>Ultra low section</i>			
5.9-10	4.5	483	148
6.5-13	4.5	586	166
6.9-13	4.5	600	172
7.3-13	5	614	184

<sup>(1)</sup> Tolerances: see sections 6.1.4 and 6.1.5 of Annex II.<sup>(2)</sup> The following size designations are accepted: 185-14/7.35-14 or 185-14 or 7.35-14 or 7.35-14/185-14.

▼B

**TABLE 2**  
**Tyres in radial construction**

Tyre size designation	Measuring rim width (inches)	Outer diameter <sup>(1)</sup> (in mm)	Section width <sup>(1)</sup> (in mm)
5.60 R 13	4	606	145
5.90 R 13	4.5	626	155
6.40 R 13	4.5	640	170
7.00 R 13	5	644	178
7.25 R 13	5	654	184
5.90 R 14	4.5	654	155
5.60 R 15	4	656	145
6.40 R 15	4.5	690	170
6.70 R 15	5	710	180
140 R 12	4	538	138
150 R 12	4	554	150
150 R 13	4	580	149
160 R 13	4.5	596	158
170 R 13	5	608	173
150 R 14	4	606	149
180 R 15	5	676	174

<sup>(1)</sup> Tolerances: see sections 6.1.4 and 6.1.5 of Annex II.



**TABLE 3**  
**Millimetric series — radial**

Tyre size designation <sup>(2)</sup>	Measuring rim width (inches)	Outer diameter <sup>(1)</sup> (in mm)	Section width <sup>(1)</sup> (in mm)
125 R 10	3.5	459	127
145 R 10	4	492	147
125 R 12	3.5	510	178
135 R 12	4	522	184
145 R 12	4	542	
155 R 12	4.5	550	155
125 R 13	3.5	536	127
135 R 13	4	548	137
145 R 13	4	566	147
155 R 13	4.5	578	157
165 R 13	4.5	596	167
175 R 13	5	608	178
185 R 13	5.5	624	188
125 R 14	3.5	562	127
135 R 14	4	574	137
145 R 14	4	590	147
155 R 14	4.5	604	157
165 R 14	4.5	622	167
175 R 14	5	634	178
185 R 14	5.5	650	188
195 R 14	5.5	666	198
205 R 14	6	686	208
215 R 14	6	700	218
225 R 14	6.5	714	228
125 R 15	3.5	588	127
135 R 15	4	600	137
145 R 15	4	616	147
155 R 15	4.5	630	157
165 R 15	4.5	646	167
175 R 15	5	660	178
185 R 15	5.5	674	188
195 R 15	5.5	690	198
205 R 15	6	710	208
215 R 15	6	724	218
225 R 15	6.5	738	228
235 R 15	6.5	752	238
175 R 16	5	686	178
185 R 16	5.5	698	188
205 R 16	6	736	208

<sup>(1)</sup> Tolerances: see sections 6.1.4 and 6.1.5 of Annex II.

<sup>(2)</sup> On certain tyres the rim diameter can be expressed in mm:

10" = 255  
12" = 305  
13" = 330  
14" = 355  
15" = 380  
16" = 405

(example: 125 R 225).



**TABLE 4**  
**70 Series — Radial (\*)**

Tyre size designation	Measuring rim width (inches)	Outer diameter (1) (in mm)	Section width (1) (in mm)
145/70 R 10	3.5	462	139
155/70 R 10	3.5	474	146
165/70 R 10	4.5	494	165
145/70 R 12	4	512	144
155/70 R 12	4	524	151
165/70 R 12	4.5	544	165
175/70 R 12	5	552	176
145/70 R 13	4	538	144
155/70 R 13	4	550	151
165/70 R 13	4.5	568	165
175/70 R 13	4.5	580	176
185/70 R 13	5	598	186
195/70 R 13	5.5	608	197
205/70 R 13	5.5	625	204
145/70 R 14	4	564	144
155/70 R 14	4	576	151
165/70 R 14	4.5	592	165
175/70 R 14	5	606	176
185/70 R 14	5	624	186
195/70 R 14	5.5	636	197
205/70 R 14	5.5	652	206
215/70 R 14	6	665	217
225/70 R 14	6	677	225
235/70 R 14	6.5	694	239
245/70 R 14	6.5	705	243
145/70 R 15	4	590	144
155/70 R 15	4	602	151
165/70 R 15	4.5	618	165
175/70 R 15	5	632	176
185/70 R 15	5	648	186
195/70 R 15	5.5	656	197
205/70 R 15	5.5	669	202
215/70 R 15	6	682	213
225/70 R 15	6	696	220
235/70 R 15	6.5	712	234
245/70 R 15	6.5	720	239

(\*) Dimensional data applicable to some tyres in existence. For new approvals, dimensions calculated according to sections 6.1.1.1 and 6.1.2.1 of Annex II apply.

(1) Tolerances: see sections 6.1.4 and 6.1.5 of Annex II.

▼B

**TABLE 5**  
**60 Series radial (\*)**

Tyre size designation	Measuring rim width (inches)	Outer diameter (1) (in mm)	Section width (1) (in mm)
165/60 R 12	5	504	167
165/60 R 13	5	530	167
175/60 R 13	5.5	536	178
185/60 R 13	5.5	548	188
195/60 R 13	6	566	198
205/60 R 13	6	578	208
215/60 R 13	6	594	218
225/60 R 13	6.5	602	230
235/60 R 13	6.5	614	235
165/60 R 14	5	554	167
175/60 R 14	5.5	562	178
185/60 R 14	5.5	574	188
195/60 R 14	6	590	198
205/60 R 14	6	604	208
215/60 R 14	6	610	215
225/60 R 14	6	620	220
235/60 R 14	6.5	630	231
245/60 R 14	6.5	642	237
265/60 R 14	7	670	260
185/60 R 15	5.5	600	188
195/60 R 15	6	616	198
205/60 R 15	6	630	208
215/60 R 15	6	638	216
225/60 R 15	6.5	652	230
235/60 R 15	6.5	664	236
255/60 R 15	7	688	255
205/60 R 16	6	654	208
215/60 R 16	6	662	215
225/60 R 16	6	672	226
235/60 R 16	6.5	684	232

(\*) Dimensional data applicable to some tyres in existence. For new approvals, dimensions calculated according to sections 6.1.1.1 and 6.1.2.1 of Annex III apply.

(1) Tolerances: see sections 6.1.4 and 6.1.5 of Annex II.

**TABLE 6**  
**High flotation tyres — radial**

Tyre size designation	Measuring rim width (inches)	Outer diameter (1) (in mm)	Section width (1) (in mm)
27 × 8.50 R 14	7	674	218
30 × 9.50 R 15	7.5	750	240
31 × 10.50 R 15	8.5	775	268
31 × 11.50 R 15	9	775	290
32 × 11.50 R 15	9	801	290
33 × 12.50 R 15	10	826	318

(1) Tolerances: see sections 6.1.4 and 6.1.5 of Annex II.



## PART B: COMMERCIAL VEHICLE TYRES

TABLE 1

## Commercial vehicle tyres

RADIAL NORMAL SECTION SIZES MOUNTED ON 5°-TAPERED OR FLAT BASE RIMS

Tyre size designation	Measuring-rim width (in inches)	Outer diameter (in mm)	Section width (in mm)
6.50 R 20	5.00	860	181
7.00 R 16	5.50	784	198
7.00 R 18	5.50	842	198
7.00 R 20	5.50	892	198
7.50 R 16 and/or A16 or 1-16	6.00	802	210
7.50 R 17 and/or A17 or 1-17	6.00	852	210
7.50 R 20 and/or A20 or 1-20	6.00	928	210
8.25 R 16 and/or B16 or 2-16	6.50	860	230
8.25 R 17 and/or B17 or 2-17	6.50	886	230
8.25 R 20 and/or B20 or 2-20	6.50	962	230
9.00 R 16 and/or C16 or 3-16	6.50	912	246
9.00 R 20 and/or C20 or 3-20	7.00	1 018	258
10.00 R 20 and/or D20 or 4-20	7.50	1 052	275
10.00 R 22 and/or D22 or 4-22	7.50	1 102	275
11.00 R 16	6.50	980	279
11.00 R 20 and/or E20 or 5-20	8.00	1 082	286
11.00 R 22 and/or E22 or 5-22	8.00	1 132	286
11.00 R 24 and/or E24 or 5-24	8.00	1 182	286
12.00 R 20 and/or F20 or 6-20	8.50	1 122	313
12.00 R 22	8.50	1 174	313
12.00 R 24 and/or F24 or 6-24	8.50	1 226	313
13.00 R 20	9.00	1 176	336
14.00 R 20 and/or G20 or 7-20	10.00	1 238	370
14.00 R 22	10.00	1 290	370
14.00 R 24	10.00	1 340	370

*Tolerances:* see sections 6.1.4 and 6.1.5 of Annex II.

▼B

**TABLE 2**  
**Commercial vehicle tyres**

## DIAGONAL

## DIAGONAL NORMAL SECTION SIZES MOUNTED ON 5°-TAPERED OR FLAT BASE RIMS

Tyre size designation	Measuring-rim width (in inches)	Outer diameter (in mm)	Section width (in mm)
7.00-16	5.50	774	198
7.00-20	5.50	898	198
7.50-16 and/or A16 or 1-16	6.00	806	210
7.50-17 and/or A17 or 1-17	6.00	852	210
7.50-20 and/or A20 or 1-20	6.00	928	213
8.25-16 and/or B16 or 2-16	6.50	860	234
8.25-17 and/or B17 or 2-17	6.50	895	234
8.25-20 and/or B20 or 2-20	6.50	970	234
9.00-16	6.50	900	252
9.00-20 and/or C20 or 3-20	7.00	1 012	256
9.00-24 and/or C24 or 3-24	7.00	1 114	256
10.00-20 and/or D20 or 4-20	7.50	1 050	275
10.00-22 and/or D22 or 4-22	7.50	1 102	275
11.00-20 and/or E20 or 5-20	8.00	1 080	291
11.00-22 and/or E22 or 5-22	8.00	1 130	291
11.00-24 and/or E24 or 5-24	8.00	1 180	291
12.00-18	8.50	1 070	312
12.00-20 and/or F20 or 6-20	8.50	1 120	312
12.00-22 and/or F22 or 6-22	8.50	1 172	312
12.00-24 and/or F24 or 6-24	8.50	1 220	312
13.00-20	9.00	1 170	342
14.00-20 and/or G20 or 7-20	10.00	1 238	375
14.00-22 and/or G22 or 7-22	10.00	1 290	375
14.00-24 and/or G24 or 7-24	10.00	1 340	375
15.00-20	11.25	1 295	412
16.00-20	13.00	1 370	446

*Tolerances:* see sections 6.1.4 and 6.1.5 of Annex II.

▼B**TABLE 3****Commercial vehicle tyres**

RADIAL NORMAL SECTION SIZES MOUNTED ON 15°-TAPERED RIMS (DROP-CENTRE)

Tyre size designation	Measuring-rim width (in inches)	Outer diameter (in mm)	Section width (in mm)
8 R 17.5	6.00	784	208
8.5 R 17.5	6.00	802	215
9 R 17.5	6.75	820	230
9.5 R 17.5	6.75	842	240
10 R 17.5	7.50	858	254
11 R 17.5	8.25	900	279
7 R 19.5	5.25	800	185
8 R 19.5	6.00	856	208
8 R 22.5	6.00	936	208
9 R 19.5	6.75	894	230
9 R 22.5	6.75	970	230
9.5 R 19.5	6.75	916	240
10 R 19.5	7.50	936	254
10 R 22.5	7.50	1 020	254
11 R 19.5	8.25	970	279
11 R 22.5	8.25	1 050	279
11 R 24.5	8.25	1 100	279
12 R 19.5	9.00	1 008	300
12 R 22.5	9.00	1 084	300
13 R 22.5	9.75	1 124	320

**TABLE 4**

DIAGONAL NORMAL SECTION SIZES MOUNTED ON 15°-TAPERED RIMS (DROP-CENTRE)

Tyre size designation	Measuring-rim width (in inches)	Outer diameter (in mm)	Section width (in mm)
8-19.5	6.00	856	208
9-19.5	6.75	894	230
9-22.5	6.75	970	230
10-22.5	7.50	1 020	254
11-22.5	8.25	1 054	279
11-24.5	8.25	1 100	279
12-22.5	9.00	1 084	300

*Tolerance:* see sections 6.1.4 and 6.1.5 of Annex II.



▼B**TABLE 5****Commercial vehicle tyres**

RADIAL 'WIDE BASE' SIZES MOUNTED ON 15°-TAPERED RIMS (DROP-CENTRE)

Tyre size designation	Measuring-rim width (in inches)	Outer diameter (in mm)	Section width (in mm)
14 R 19.5	10.50	962	349
15 R 19.5	11.75	998	387
15 R 22.5	11.75	1 074	387
16.5 R 19.5	13.00	1 046	425
16.5 R 22.5	13.00	1 122	425
18 R 19.5	14.00	1 082	457
18 R 22.5	14.00	1 158	457
19.5 R 19.5	15.00	1 134	495
21 R 22.5	16.50	1 246	540

**TABLE 6**

DIAGONAL 'WIDE BASE' SIZES MOUNTED ON 15°-TAPERED RIMS (DROP-CENTRE)

Tyre size designation	Measuring-rim width (in inches)	Outer diameter (in mm)	Section width (in mm)
15-19.5	11.75	1 004	387
15-22.5	11.75	1 080	387
16.5-19.5	13.00	1 052	425
16.5-22.5	13.00	1 128	425
18-19.5	14.00	1 080	457
18-22.5	14.00	1 156	457
19.5-19.5	15.00	1 138	495
21-22.5	16.50	1 246	540

*Tolerances:* see sections 6.1.4 and 6.1.5 of Annex II.

**TABLE 7****Commercial vehicle tyres**

RADIAL '80' SERIES MOUNTED ON 5° TAPERED OR FLAT-BASE RIMS

Tyre size designation	Measuring-rim width (in inches)	Outer diameter (in mm)	Section width (in mm)
12/80 R 20	8.50	1 008	305
13/80 R 20	9.00	1 048	326
14/80 R 20	10.00	1 090	350
14/80 R 24	10.00	1 192	350
14.75/80 R 20	10.00	1 124	370
15.5/80 R 20	10.00	1 158	384

**TABLE 8**

RADIAL '70' SERIES MOUNTED ON 15° TAPERED RIMS (DROP-CENTRE)

Tyre size designation	Measuring-rim width (in inches)	Outer diameter (in mm)	Section width (in mm)
9/70 R 22.5	6.75	892	229
10/70 R 22.5	7.50	928	254
11/70 R 22.5	8.25	962	279
12/70 R 22.5	9.00	999	305
13/70 R 22.5	9.75	1 033	330

**TABLE 9**

RADIAL '80' SERIES MOUNTED ON 15° TAPERED RIMS (DROP-CENTRE)

Tyre size designation	Measuring-rim width (in inches)	Outer diameter (in mm)	Section width (in mm)
12/80 R 22.5	9.00	1 046	305

*Tolerances:* see sections 6.1.4 and 6.1.5 of Annex II.

▼B**TABLE 10****Commercial vehicle tyres**

RADIAL TYRES FOR LIGHT COMMERCIAL VEHICLES MOUNTED ON RIM OF 16" DIAMETER AND OVER

Tyre size designation	Measuring-rim width (in inches)	Outer diameter (in mm)	Section width (in mm)
6.00 R 16 C	4.50	728	170
6.00 R 18 C	4.00	782	165
6.50 R 16 C	4.50	742	176
6.50 R 17 C	4.50	772	176
6.50 R 17 LC	4.50	726	166
6.50 R 20 C	5.00	860	181
7.00 R 16 C	5.50	778	198
7.50 R 16 C	6.00	802	210
7.50 R 17 C	6.00	852	210

**TABLE 11**

DIAGONAL TYRES FOR LIGHT COMMERCIAL VEHICLES MOUNTED ON RIM OF 16" DIAMETER AND OVER

Tyre size designation	Measuring-rim width (in inches)	Outer diameter (in mm)	Section width (in mm)
6.00-16 C	4.50	730	170
6.00-18 C	4.00	786	165
6.00-20 C	5.00	842	172
6.50-20 C	4.50	748	176
6.50-17 LC	4.50	726	166
6.50-20 C	5.00	870	181
7.00-16 C	5.50	778	198
7.00-18 C	5.50	848	198
7.00-20 C	5.50	898	198
7.50-16 C	6.00	806	210
7.50-17 C	6.00	852	210
8.25-16 C	6.50	860	234
8.90-16 C	6.50	885	250
9.00-16 C	6.50	900	252

*Tolerances:* see sections 6.1.4 and 6.1.5 of Annex II.

▼B

**TABLE 12**  
**Commercial vehicle tyres**

RADIAL TYRES FOR LIGHT COMMERCIAL VEHICLES MOUNTED ON 5°  
TAPERED RIMS

Rim diameter 12" — 15"

(DROP-CENTRE)

Tyre size designation	Measuring-rim width (in inches)	Outer diameter (in mm)	Section width (in mm)
‘Super balloon’ series			
5.60 R 12 C	4.00	570	150
6.40 R 13 C	5.00	648	172
6.70 R 13 C	5.00	660	180
6.70 R 14 C	5.00	688	180
6.70 R 15 C	5.00	712	180
7.00 R 15 C	5.50	744	195
‘Low section’ series			
6.50 R 14 C	5.00	640	170
7.00 R 14 C	5.00	650	180
7.50 R 14 C	5.50	686	195

TYRES FOR LIGHT COMMERCIAL VEHICLES MOUNTED ON 15° TAPERED RIMS  
(DROP-CENTRE)

Tyre size designation	Measuring-rim width (in inches)	Outer diameter (in mm)	Section width (in mm)
7 R 17.5 C	5.25	752	185
8 R 17.5 C	6.00	784	208

*Tolerances:* see sections 6.1.4 and 6.1.5 of Annex II.

**TABLE 13****Commercial vehicle tyres**

DIAGONAL TYRES FOR LIGHT COMMERCIAL VEHICLES MOUNTED ON 5°  
TAPERED RIMS (DROP CENTRE) Rim diameter 12" — 15"

Tyre size designation	Measuring-rim width (in inches)	Outer diameter (in mm)	Section width (in mm)
‘Super balloon’ series			
5.20-12 C	3.50	560	136
5.60-12 C	4.00	572	148
5.60-13 C	4.00	598	148
5.90-13 C	4.50	616	158
5.90-14 C	4.50	642	158
5.90-15 C	4.50	668	158
6.40-13 C	5.00	640	172
6.40-14 C	5.00	666	172
6.40-15 C	5.00	692	172
6.40-16 C	4.50	748	172
6.70-13 C	5.00	662	180
6.70-14 C	5.00	688	180
6.70-15 C	5.00	714	180
‘Low section’ series			
5.50-12 C	4.00	552	142
6.00-12 C	4.50	574	158
6.00-14 C	4.50	626	158
6.50-14 C	5.00	650	172
6.50-15 C	5.00	676	172
7.00-14 C	5.00	668	182
7.50-14 C	5.50	692	192
‘Balloon’ series			
7.00-15 C	5.50	752	198
7.50-15 C	6.00	780	210
‘Millimetric’ series			
125-12 C	3.50	514	127
165-15 C	4.50	652	167
185-14 C	5.50	654	188
195-14 C	5.50	670	198
245-16 C	7.00	798	248
17-15 C or	5.00	678	178
17-380 C	5.00	678	178
17-400 C	19 × 400 mm	702	186
19-400 C	19 × 400 mm	736	200
21-400 C	19 × 400 mm	772	216

*Tolerances:* see sections 6.1.4 and 6.1.5 of Annex II.

▼B

TABLE 14

## Commercial vehicle tyres

RADIAL TYRES FOR LIGHT COMMERCIAL VEHICLES MOUNTED ON 5°  
TAPERED RIMS (DROP-CENTRE) RIMS

'Millimetric' series

Tyre size designation	Measuring-rim width (in inches)	Outer diameter (in mm)	Section width (in mm)
125 R 12 C	3.50	510	127
125 R 13 C	3.50	536	127
125 R 14 C	3.00	562	127
125 R 15 C	3.50	588	127
135 R 12 C	4.00	522	137
135 R 13 C	4.00	548	137
135 R 14 C	4.00	574	137
135 R 15 C	4.00	600	137
145 R 10 C	4.00	492	147
145 R 12 C	4.00	542	147
145 R 13 C	4.00	566	147
145 R 14 C	4.00	590	147
145 R 15 C	4.00	616	147
155 R 12 C	4.50	550	157
155 R 13 C	4.50	578	157
155 R 14 C	4.50	604	157
155 R 15 C	4.50	630	157
155 R 16 C	4.50	656	157
165 R 13 C	4.50	596	167
165 R 14 C	4.50	622	167
165 R 15 C	4.50	646	167
165 R 16 C	4.50	672	167
175 R 13 C	5.00	608	178
175 R 14 C	5.00	634	178
175 R 15 C	5.00	660	178
175 R 16 C	5.00	684	178
185 R 13 C	5.50	624	188
185 R 14 C	5.50	650	188
185 R 15 C	5.50	674	188
185 R 16 C	5.50	700	188
195 R 14 C	5.50	666	198
195 R 15 C	5.50	690	198
195 R 16 C	5.50	716	198
205 R 14 C	6.00	686	208
205 R 15 C	6.00	710	208
205 R 16 C	6.00	736	208
215 R 14 C	6.00	700	218
215 R 15 C	6.00	724	218
215 R 16 C	6.00	750	218
225 R 14 C	6.50	714	228
225 R 15 C	6.50	738	228
225 R 16 C	6.50	764	228
235 R 14 C	6.50	728	238

**▼B**

Tyre size designation	Measuring-rim width (in inches)	Outer diameter (in mm)	Section width (in mm)
235 R 15 C	6.50	752	238
235 R 16 C	6.50	778	238
17 R 15 C or	5.00	678	178
17 R 380 C	5.00	678	178
17 R 400 C	19 × 400 mm	698	186
19 R 400 C	19 × 400 mm	728	200

*Tolerances:* see sections 6.1.4 and 6.1.5 of Annex II.

▼B**TABLE 15****Commercial vehicle tyres**DIAGONAL WIDE-BASE TYRES FOR MULTIPURPOSE TRUCKS ON HIGHWAY,  
OFF-THE-ROAD AND AGRICULTURAL SERVICES

Tyre size designation	Measuring-rim width (in inches)	Outer diameter (in mm)	Section width (in mm)
10.5-18 MPT	9	905	270
10.5-20 MPT	9	955	270
12.5-18 MPT	11	990	325
12.5-20 MPT	11	1 040	325
14.5-20 MPT	11	1 095	355
14.5-24 MPT	11	1 195	355
7.50-18 MPT	5.50	885	208

**TABLE 16**RADIAL WIDE-BASE TYRES FOR MULTIPURPOSE TRUCKS ON HIGHWAY, OFF-  
THE-ROAD AND AGRICULTURAL SERVICES

Tyre size designation	Measuring-rim width (in inches)	Outer diameter (in mm)	Section width (in mm)
10.5 R 20 MPT	9	955	276
12.5 R 20 MPT	11	1 040	330
14.5 R 20 MPT	11	1 095	362
14.5 R 24 MPT	11	1 195	362

*Tolerances:* see sections 6.1.4 and 6.1.5 of Annex II.



**TABLE 17****Commercial vehicle tyres****RADIAL 'FREE-ROLLING' TYRES IN HIGHWAY SERVICE**

Tyre size designation	Measuring-rim width (in inches)	Outer diameter (in mm)	Section width (in mm)
5.00 R 8	3.00	467	132
6.00 R 9	4.00	540	160
7.00 R 12	5.00	672	192
7.50 R 15	6.00	772	212
8.25 R 15	6.50	836	234
10.00 R 15	7.50	918	275

**TABLE 18****DIAGONAL 'FREE-ROLLING' TYRES IN HIGHWAY SERVICE**

Tyre size designation	Measuring-rim width (in inches)	Outer diameter (in mm)	Section width (in mm)
6.00-9	4.00	540	160
7.00-12	5.00	672	192
7.00-15	5.00	746	192
7.50-15	6.00	772	212
8.25-15	6.50	836	234
10.00-15	7.50	918	275
200-15	6.50	730	205

**TABLE 19****DIAGONAL '75' SERIES MOUNTED ON 15° TAPERED RIMS**

Tyre size designation	Measuring-rim width (in inches)	Outer diameter (in mm)	Section width (in mm)
7.25/75-16.5 or 7.25-16.5	5.25	695	182
8.00/75-16.5 or 8.00-16.5	6.00	724	203
8.75/75-16.5 or 8.75-16.5	6.75	752	224
9.50/75-16.5 or 9.50-16.5	7.50	781	245

*Tolerances:* see sections 6.1.4 and 6.1.5 of Annex II.

▼B

TABLE 20

## Commercial vehicle tyres

## DIAGONAL

## DIAGONAL AND RADIAL TYRES MOUNTED ON FLAT BASE OR DIVIDED RIMS

Tyre size designation	Measuring-rim width (in inches)	Outer diameter (in mm)	Section width (in mm)
3.00-4	2.10	255	81
4.00-4	2.50	312	107
4.00-8	2.50	414	107
5.00-8	3.00	467	132
6.50-10	5.00	588	177
7.00-9	5.00	562	174
7.50-10	5.50	645	207
8.25-10	6.50	698	240
10.50-13	6.00	889	275
10.50-16	6.00	965	275
11.00-16	6.00	952	272
14.00-16	10.00	1 139	375
15 × 4.5-2	3.25	385	122
16 × 6-8	4.33	425	152
18 × 7-8 <sup>(1)</sup>	4.33	462	173
21 × 4	2.32	565	113
21 × 8-9	6.00	535	200
23 × 9-10	6.50	595	225
22 × 4.5	3.11	595	132
23 × 5	3.75	635	155
25 × 6	3.75	680	170
27 × 6	4.33	758	188
27 × 10-12	8.00	690	255
28 × 6	3.75	760	170
28 × 9-15	7.00	707	216
(8.15-15)	7.00	707	216
29 × 7	5.00	809	211
29 × 8	6.00	809	243
9.00-15	6.00	840	249
2.50-15	7.50	735	250
3.00-15	8.00	840	300

<sup>(1)</sup> Also marked 18 × 7.

## RADIAL

Tyre size designation	Measuring-rim width (in inches)	Outer diameter (in mm)	Section width (in mm)
6.50 R 10	5.00	588	177
7.00 R 15	5.50	746	197
7.50 R 10	5.50	645	207
15 × 4.5 R 8	3.25	385	122
16 × 6 R 8	4.33	425	152
18 × 7 R 8	4.33	462	173

**▼B**

Tyre size designation	Measuring-rim width (in inches)	Outer diameter (in mm)	Section width (in mm)
560 × 165 R 11	5.00	560	175
680 × 180 R 15	5.00	680	189

*Tolerances:* see sections 6.1.4 and 6.1.5 of Annex II.

▼B

TABLE 21

**Tyres for trucks, buses, trailers and multipurpose passenger vehicles in normal highway service**  
**DIAGONAL AND RADIAL TYRES MOUNTED ON 5° DROP-CENTRE OR SEMI-DROP-CENTRE RIMS**

Tyre size designation		Measuring-rim width (in inches)	Section width (in mm) <sup>(1)</sup>	Outer diameter	
Diagonal	Radial			Highway tread (in mm) <sup>(2)</sup>	Mud and snow (in mm) <sup>(2)</sup>
6.00-16 LT	6.00 R 16 LT	4.50	173	732	743
6.50-16 LT	6.50 R 16 LT	4.50	182	755	767
6.70-15 LT	6.70 R 15 LT	5.00	191	722	733
7.00-13 LT	7.00 R 13 LT	5.00	187	647	658
7.00-14 LT	7.00 R 14 LT	5.00	187	670	681
7.00-15 LT	7.00 R 15 LT	5.50	202	752	763
7.00-16 LT	7.00 R 16 LT	5.50	202	778	788
7.10-15 LT	7.10 R 15 LT	5.00	199	738	749
7.50-15 LT	7.50 R 15 LT	6.00	220	782	794
7.50-16 LT	7.50 R 16 LT	6.00	220	808	819
8.25-16 LT	8.25 R 16 LT	6.50	241	859	869
9.00-16 LT	9.00 R 16 LT	6.50	257	890	903
D78-14 LT	DR 78-14 LT	5.00	192	661	672
E78-14 LT	ER 78-14 LT	5.50	199	667	678
C78-15 LT	CR 78-15 LT	5.00	187	672	683
G78-15 LT	GR 78-15 LT	6.00	212	711	722
H78-15 LT	HR 78-15 LT	6.00	222	727	739
L78-15 LT	LR 78-15 LT	6.50	236	749	760
F78-16 LT	FR 78-16 LT	5.50	202	721	732
H78-16 LT	HR 78-16 LT	6.00	222	753	764
L78-16 LT	LR 78-16 LT	6.50	236	775	786

<sup>(1)</sup> Overall tyre widths may exceed the above section widths by 8 %.

<sup>(2)</sup> Tolerance + 8 % of the difference between the above outer diameter and the nominal rim diameters.

▼B

TABLE 22

**Tyres for trucks, buses, trailers and multipurpose passenger vehicles in normal highway service**  
**DIAGONAL AND RADIAL TYRES MOUNTED ON 15° DROP-CENTRE RIMS**

TABLE 22.1

Tyre size designation		Measuring-rim width (inches)	Section width (mm) <sup>(1)</sup>	Outer diameter	
Diagonal	Radial			Highway tread (mm) <sup>(2)</sup>	Mud and snow (mm) <sup>(2)</sup>
7-14.5 LT	—	6.00	185	677	—
8-14.5 LT	—	6.00	203	707	—
9-14.5 LT	—	7.00	241	711	—
7-17.5 LT	7 R 17.5 LT	5.25	189	758	769
8-17.5 LT	8 R 17.5 LT	5.25	199	788	799

<sup>(1)</sup> Overall tyre widths may exceed the above section widths by 8 %.

<sup>(2)</sup> Tolerance + 8 % of the difference between the above outer diameters and the nominal rim diameters.

TABLE 22.2

Tyre size designation		Measuring-rim width (inches)	Section width (mm) <sup>(1)</sup>	Outer diameter	
Diagonal	Radial			Highway tread (mm) <sup>(2)</sup>	Mud and snow (mm) <sup>(2)</sup>
8.00-16.5 LT	8.00 R 16.5 LT	6.00	203	720	730
8.75-16.5 LT	8.75 R 16.5 LT	6.75	222	748	759
9.50-16.5 LT	9.50 R 16.5 LT	6.75	241	776	787
10-16.5 LT	10 R 16.5 LT	8.25	264	762	773
10-17.5 LT	10 R 17.5 LT	8.25	264	787	798
12-16.5 LT	12 R 16.5 LT	9.75	307	818	831
30 × 9.50-16.5 LT	30 × 9.50 R 16.5 LT	7.50	240	750	761
31 × 10.50-16.5 LT	31 × 10.50 R 16.5 LT	8.25	266	775	787
33 × 10.50-16.5 LT	33 × 12.50 R 16.5 LT	9.75	315	826	838
37 × 10.50-16.5 LT	37 × 14.50 R 16.5 LT	11.25	365	928	939

<sup>(1)</sup> Overall tyre widths may exceed the above section widths by 7 %.

<sup>(2)</sup> Tolerance + 8 % of the difference between the above outer diameter and the nominal rim diameters.



TABLE 23

## Tyres for trucks, buses, trailers in normal highway service

## DIAGONAL AND RADIAL TYRES MOUNTED ON 15° DROP-CENTRE RIMS

Tyre size designation		Measuring-rim width (inches)	Section width (mm) <sup>(1)</sup>	Outer diameter		
Diagonal	Radial			Highway tread (mm) <sup>(2)</sup>	Heavy tread (mm) <sup>(2)</sup>	Mud and snow (mm) <sup>(2)</sup>
Normal-section tyres						
7-22.5	7 R 22.5	5.25	178	878	—	894
8-19.5	8 R 19.5	6.00	203	859	—	876
8-22.5	8 R 22.5	6.00	203	935	—	952
9-22.5	9 R 22.5	6.75	229	974	982	992
10-22.5	10 R 22.5	7.50	254	1 019	1 031	1 038
11-22.5	11 R 22.5	8.25	279	1 054	1 067	1 037
11-24.5	11 R 24.5	8.25	279	1 104	1 118	1 123
12-22.5	12 R 22.5	9.00	300	1 085	1 099	1 104
12-24.5	12 R 24.5	9.00	300	1 135	1 150	1 155
12.5-22.5	12.5 R 22.5	9.00	302	1 085	1 099	1 104
12.5-22.5	12.5 R 24.5	9.00	302	1 135	1 150	1 155
Wide-base tyres						
14-17.5	14 R 17.5	10.50	349	907	—	921
15-19.5	15 R 19.5	11.75	389	1 005	—	1 019
15-22.5	15 R 22.5	11.75	389	1 082	—	1 095
16.5-19.5	16.5 R 19.5	13.00	425	1 052	—	1 068
16.5-22.5	16.5 R 22.5	13.00	425	1 128	—	1 144
18-19.5	18 R 19.5	14.00	457	1 080	—	1 096
18-22.5	18 R 22.5	14.00	457	1 158	—	1 172
19.5-19.5	19.5 R 19.5	15.00	495	1 138	—	1 156

<sup>(1)</sup> Overall tyre widths may exceed the above section widths by 6 %.

<sup>(2)</sup> Tolerance + 5 % of the difference between the above outer diameter and the nominal rim diameters.



TABLE 24

## Tyres for trucks, buses, trailers in normal highway service

## DIAGONAL AND RADIAL TYRES MOUNTED ON 5° DROP-CENTRE RIMS

Tyre size designation		Measuring-rim width (inches)	Section width (mm) <sup>(1)</sup>	Outer diameter		
Diagonal	Radial			Highway tread (mm) <sup>(2)</sup>	Heavy tread (mm) <sup>(2)</sup>	Mud and snow (mm) <sup>(2)</sup>
—	8R14LT	7.00	216	667	—	—
9-15LT	—	8.00	254	744	755	—
10-15LT	10R15LT	8.00	264	773	783	—
10-16LT	—	8.00	264	798	809	—
11-14LT	—	8.00	279	752	763	—
11-15LT	11R15LT	8.00	279	777	788	—
11-16LT	—	8.00	279	803	813	—
12-15LT	—	10.00	318	823	834	—
—	9R15LT	8.00	254	744	755	752
24 × 7.50-13LT	24 × 7.50R13LT	6.00	191	597	609	604
27 × 8.50-14LT	27 × 8.50-14LT	7.00	218	674	685	680
28 × 8.50-15LT	28 × 8.50-15LT	7.00	218	699	711	705
29 × 9.50-15LT	29 × 9.50-15LT	7.50	240	724	736	731
30 × 9.50-15LT	30 × 9.50-15LT	7.50	240	750	761	756
31 × 10.50-15LT	31 × 10.50-15LT	8.50	268	775	787	781
31 × 11.50-15LT	31 × 11.50-15LT	9.00	290	775	787	781
32 × 11.50-15LT	32 × 11.50-15LT	9.00	290	801	812	807
33 × 12.50-15LT	33 × 12.50-15LT	10.00	318	826	838	832
35 × 12.50-15LT	35 × 12.50-15LT	10.00	318	877	888	883
37 × 12.50-15LT	37 × 12.50-15LT	10.00	318	928	939	934
31 × 13.50-15LT	31 × 13.50-15LT	11.00	345	775	787	781
37 × 14.50-15LT	37 × 14.50-15LT	12.00	372	928	939	934
31 × 15.50-15LT	31 × 15.50-15LT	12.00	390	775	787	781

<sup>(1)</sup> Overall tyre widths may exceed the above section widths by 6 %.

<sup>(2)</sup> Tolerance + 6 % of the difference between the above outer diameter and the nominal rim diameters.

**TABLE 25****Tyres for trucks, buses and trailers in normal highway service****DIAGONAL AND RADIAL TYRES MOUNTED ON MULTI-PIECE BYMS**

Tyre size designation		Measuring-rim width (inches)	Section width (mm) <sup>(1)</sup>	Outer diameter		
Diagonal	Radial			Highway tread (mm) <sup>(2)</sup>	Heavy tread (mm) <sup>(2)</sup>	Mud and snow (mm) <sup>(2)</sup>
6.50-20	6.50R20	5.00	184	878	—	1 049
7.00-15TR	7.00R15TR	5.50	199	777	—	962
7.00-17	7.00R17	5.50	199	828	—	843
7.00-18	7.00R18	5.50	199	853	—	868
7.00-20	7.00R20	5.50	199	904	—	919
7.50-15TR	7.50R15TR	6.00	215	808	—	825
7.50-17	7.50R17	6.00	215	859	—	876
7.50-18	7.50R18	6.00	215	884	—	981
7.50-20	7.50R20	6.00	215	935	—	952
8.25-15TR	8.25R15TR	6.50	236	847	855	865
8.25-17	8.25R17	6.50	236	898	906	915
8.25-20	8.25R20	6.50	236	974	982	992
9.00-15TR	9.00R15TR	7.00	259	891	904	911
9.00-20	9.00R20	7.00	259	1 019	1 031	1 038
10.00-15TR	10.00R15TR	7.50	278	927	940	946
10.00-20	10.00R20	7.50	278	1 054	1 067	1 073
10.00-22	10.50R22	7.50	278	1 104	1 118	1 123
11.00-15TR	11.00R15TR	8.00	293	958	972	977
11.00-20	11.00R20	8.00	293	1 085	1 099	1 104
11.00-22	11.00R22	8.00	293	1 135	1 150	1 155
11.00-24	11.00R24	8.00	293	1 186	1 201	1 206
11.50-20	11.50R20	8.00	296	1 085	1 099	1 104
11.50-22	11.50R22	8.00	296	1 135	1 150	1 155
12.50-20	12.00R20	8.50	315	1 125	—	1 146
12.50-24	12.00R24	8.50	315	1 226	—	1 247

<sup>(1)</sup> Overall tyre widths may exceed the above section widths by 6 %.

<sup>(2)</sup> Tolerance + 6 % of the difference between the above outer diameter and the nominal rim diameters.



**TABLE 26****Tyres for trucks and trailers in highway service at restricted speeds****DIAGONAL AND RADIAL TYRES MOUNTED ON MULTI-PIECE RIMS**

Tyre size designation		Measuring-rim width (inches)	Section width (mm) <sup>(1)</sup>	Outer diameter	
Diagonal	Radial			Highway tread (mm) <sup>(2)</sup>	Mud and snow (mm) <sup>(2)</sup>
13.00-20	13.00R20	9.00	340	1 177	1 200
14.00-20	14.00R20	10.00	375	1 241	1 266
14.00-24	14.00R24	10.00	375	1 343	1 368

<sup>(1)</sup> Overall tyre widths may exceed the above section widths by 6 %.

<sup>(2)</sup> Tolerance + 6 % of the difference between the above outer diameter and the nominal rim diameters.

**TABLE 27****Tyres for mobile homes in highway service****DIAGONAL**

Tyre size designation	Measuring-rim width (inches)	Section width (mm) <sup>(1)</sup>	Outer diameter (mm) <sup>(2)</sup>
Tyres mounted on 15° drop-centre rims			
7-14.5 MH	6.00	185	677
8-14.5 MH	6.00	203	707
9-14.5 MH	7.00	241	711
Tyres mounted on 5° drop-centre and semi-drop-centre rims			
7.00-15 MH	5.50	202	752

<sup>(1)</sup> Overall tyre widths may exceed the above section widths by 8 %.

<sup>(2)</sup> Tolerance + 8 % of the difference between the above outer diameter and the nominal rim diameters.

▼B

TABLE 28

## Mining and logging tyres in intermittent highway service

## DIAGONAL

Tyre size designation	Measuring-rim width (inches)	Section width (mm) (1)	Outer diameter	
			Traction tread (mm) (2)	Extra tread (mm) (2)
Tyres mounted on 15° drop-centre rims				
7.00-20 ML	5.50	199	919	—
7.50-20 ML	6.00	215	952	—
8.25-20 ML	6.50	236	992	—
9.00-20 ML	7.00	259	1 038	1 063
10.00-20 ML	7.50	278	1 073	1 099
10.00-22 ML	7.50	278	1 123	1 150
10.00-20 ML	7.50	278	1 174	1 200
11.00-20 ML	8.00	293	1 104	1 131
11.00-22 ML	8.00	293	1 155	1 182
11.00-24 ML	8.00	293	1 206	1 233
12.00-20 ML	8.50	315	1 146	1 173
12.00-24 ML	8.50	315	1 247	1 275
13.00-20 ML	9.00	340	1 200	—
13.00-24 ML	9.00	340	1 302	—
14.00-20 ML	10.00	375	1 266	—
14.00-24 ML	10.00	375	1 368	—
Tyres mounted on full-tapered bead seat rims				
11.00-25 ML	8.50	298	1 206	1 233
12.00-21 ML	8.50	315	1 146	1 175
12.00-25 ML	8.50	315	1 247	1 275
13.00-25 ML	10.00	351	1 302	—
14.00-21 ML	10.00	375	1 266	—
14.00-25 ML	10.00	375	1 368	—
Tyres mounted on 15° drop-centre rims				
9-22.5 ML	6.75	229	992	—
10-22.5 ML	7.50	254	1 038	—
11-22.5 ML	8.25	279	1 073	—
11-24.5 ML	8.25	279	1 123	—
12-22.5 ML	9.00	300	1 104	—
Tyres mounted on 15° drop-centre rims				
14-17.5 ML	10.50	349	921	—
15-19.5 ML	11.75	389	1 019	—
15-22.5 ML	11.75	389	1 095	—
16.5-19.5 ML	13.00	425	1 068	—
16.5-22.5 ML	13.00	425	1 144	—
18-19.5 ML	14.00	457	1 096	—
18-22.5 ML	14.00	457	1 172	—
19.5-19.5 ML	15.00	495	1 156	—

**▼B**

Tyre size designation	Measuring-rim width (inches)	Section width (mm) <sup>(1)</sup>	Outer diameter	
			Traction tread (mm) <sup>(2)</sup>	Extra tread (mm) <sup>(2)</sup>
23-23.5 ML	17.00	584	1 320	—

<sup>(1)</sup> Overall tyre widths may exceed the above section widths by 8 %.

<sup>(2)</sup> Tolerance + 6 % of the difference between the above outer diameter and the nominal rim diameters.



## Appendix 6

**METHOD OF MEASURING TYRE DIMENSIONS**

(see Annex II section 6.1.3)

## PART A: PASSENGER CAR TYRES

- 1.1. The tyre is mounted on the measuring rim specified by the manufacturer pursuant to section 6.11 of Annex I, Appendix 1.
- 1.2. The pressure in the tyre is then adjusted as follows:
  - 1.2.1. in standard bias — belted tyres to 1,7 bar;
  - 1.2.2. in diagonal (bias-ply) tyres to the pressure shown below (bar):

Ply-rating	Speed category		
	L, M, N	P, Q, R, S	T, U, H, V
4	1,7	2,0	—
6	2,1	2,4	2,6
8	2,5	2,8	3,0

- 1.2.3. in standard radial tyres to 1,8 bar,
- 1.2.4. in reinforced tyres to 2,3 bar, and
- 1.2.5. in T-type temporary-use spare tyres: to 4,2 bar.
2. The tyre, mounted on its rim, is conditioned at the ambient room temperature for not less than 24 hours, with the exception referred to in section 6.2.3 of Annex II.
3. The pressure is readjusted to that specified in section 1.2.
4. The overall width is measured by caliper at six equally-spaced points, account being taken of the thickness of the protective ribs or bands. The highest measurement so obtained is taken as the overall width.
5. The outer diameter is determined by measuring the maximum circumference and dividing the figure so obtained by  $\pi$  (3,1416).

## PART B: COMMERCIAL VEHICLE TYRES

1. The tyre is mounted on the measuring rim specified by the manufacturer pursuant to section 6.11 of Appendix 1 to Annex I and is inflated to a pressure specified by the manufacturer pursuant to section 6.12 of Annex I, Appendix 1.
2. The tyre fitted on its rim is conditioned to the ambient temperature of the laboratory for at least 24 hours.
3. The pressure is readjusted to the value specified in section 1.
4. The overall width is measured by caliper at six equally-spaced points, account being taken of the thickness of the protective ribs or bands. The highest measurement so obtained is taken as the overall width.
5. The outer diameter is determined by measuring the maximum circumference and dividing the figure so obtained by  $\pi$  (3,1416).



## Appendix 7

**LOAD/SPEED TEST-PROCEDURE <sup>(1)</sup>**

(see Annex II, section 6.2)

## PART A: PASSENGER CAR TYRES

**1. Preparing the tyre**

- 1.1. A new tyre is mounted on the test rim specified by the manufacturer pursuant to section 6.11 of Annex I, Appendix 1.
- 1.2. It is inflated to the appropriate pressure as given in the table below:

**Test pressure (bar)**

Speed category	Diagonal (bias-ply) tyres			Radial tyres		Bias-belted tyres
	Ply-rating			Standard	Reinforced	Standard
	4	6	8			
L, M, N	2,3	2,7	3,0	2,4	—	—
P, Q, R, S	2,6	3,0	3,3	2,6	3,0	2,6
T, U, H	2,8	3,2	3,5	2,8	3,2	2,8
V	3,0	3,4	3,7	3,0	—	—

T-type temporary use spare tyres: to 4,2 bars.

- 1.3. The manufacturer may request, giving reasons, the use of an inflation pressure differing from those under section 1.2. In such a case the tyre is inflated to that pressure (see section 6.14 of Appendix 1 to Annex I).
- 1.4. The tyre-and-wheel assembly is conditioned at test-room temperature for not less than three hours.
- 1.5. The tyre pressure is readjusted to that specified in section 1.2 or 1.3.

**2. Carrying out the test**

- 2.1. The tyre-and-wheel assembly is mounted on a test axle and pressed against the outer face of a smooth wheel 1,70 m ± 1 % or 2 m ± 1 % in diameter.
- 2.2. Apply to the test axle a load equal to 80 % of:
  - 2.2.1. the maximum load rating equated to the load capacity index for tyres with speed symbols L to H inclusive;
  - 2.2.2. the maximum load rating associated with a maximum speed of 240 km/h for tyres with speed symbol 'V' (see section 2.31.2 of Annex II).
- 2.3. Throughout the test the tyre pressure must not be corrected and the test load must be kept constant.
- 2.4. During the test the temperature in the test-room must be maintained at between 20 °C and 30 °C or at a higher temperature if the manufacturer agrees.
- 2.5. The test is carried out without interruption in conformity with the following particulars:
  - 2.5.1. time taken to pass from zero speed to initial test speed: 10 minutes;

<sup>(1)</sup> In the case of passenger car tyres intended for vehicles designed for a maximum speed greater than 240 km/h (Z rated tyres), until uniform test procedures have been agreed the manufacturer of the tyre must satisfy the technical service that his test procedure and results are acceptable.

**▼B**

- 2.5.2. initial test speed: prescribed maximum speed for the type of tyre, less 40 km/h in the case of the smooth wheel having  $1,70 \text{ m} \pm 1 \%$  in diameter or less 30 km/h in the case of the smooth wheel having  $2 \text{ m} \pm 1 \%$  in diameter;
- 2.5.3. successive speed increments: 10 km/h;
- 2.5.4. duration of test at each speed step except the last: 10 minutes;
- 2.5.5. duration of test at last speed step: 20 minutes;
- 2.5.6. maximum test speed: prescribed maximum speed for the type of tyre, less 10 km/h in the case of the smooth wheel having  $1,7 \text{ m} \pm 1 \%$  in diameter or equal to prescribed maximum speed in the case of the smooth wheel having  $2 \text{ m} \pm 1 \%$  in diameter.

**3. Equivalent test methods**

If a method other than that described in section 2 is used, its equivalence must be demonstrated.

**PART B: COMMERCIAL VEHICLE TYRES <sup>(1)</sup>****1. Preparing the tyre**

- 1.1. Mount a new tyre on the test rim specified by the manufacturer pursuant to section 6.11 of Appendix 1 to Annex I.
- 1.2. Use a new inner tube or combination of inner tube, valve and flap (as required) when testing tyres with inner tubes.
- 1.3. Inflate the tyre to the pressure corresponding to the pressure index specified by the tyre manufacturer, pursuant to section 6.14 of Appendix 1 to Annex I.
- 1.4. Condition the tyre and wheel assembly at test room temperature for not less than three hours.
- 1.5. Readjust the tyre pressure to that specified in section 1.3.

**2. Test procedure**

- 2.1. Mount the tyre and wheel assembly on the test axle and press it against the outer face of a smooth power-driven test drum  $1,70 \text{ m} \pm 1 \%$  in diameter having a surface at least as wide as the tyre tread.
- 2.2. Apply to test axle a series of test loads expressed as a percentage of the load indicated in Appendix 2, opposite the load index moulded on the sidewall of the tyre, in accordance with the load/speed test programme shown in the Table below. When the tyre has load capacity indices for both single and twin utilization, the reference load for single utilization is taken as the basis for the test loads.
- 2.3. The tyre pressure must not be corrected throughout the test and the test load must be kept constant throughout each of the three test stages.
- 2.4. During the test the temperature in the test room must be maintained at between  $20 \text{ }^\circ\text{C}$  and  $30 \text{ }^\circ\text{C}$  or at a higher temperature if the manufacturer so agrees.
- 2.5. The load/speed test programme must be carried out without interruption.

<sup>(1)</sup> In the case of commercial vehicle tyres intended for vehicles designed for a maximum speed greater than 150 km/h, until uniform test procedures have been agreed the manufacturer of the tyre must satisfy the technical service that his test procedure and results are acceptable.

▼B3. **Equivalent test methods**

If a method other than that described in section 2 is used, its equivalence must be demonstrated.

**LOAD/SPEED TEST PROGRAMME**

Load index	Tyre speed category symbol	Test-drum speed (rev/min) <sup>(1)</sup>		Load placed on the wheel as a percentage of the load corresponding to the load index		
		Radial-ply tyre	Diagonal (bias-ply) tyre	7 h.	16 h.	24 h.
122 or more	F	100	100	66 %	84 %	101 %
	G	125	100			
	J	150	125			
	K	175	150			
	L	200	—			
	M	225	—			
121 or less	F	100	100	70 %	88 %	106 %
	G	125	125			
	J	150	150			
	K	175	175			
	L	200	175	4 h.	6 h.	114 %
				75 %	97 %	
	M	250	200	75 %	97 %	114 %
	N	275	—	75 %	97 %	114 %
	P	300	—	75 %	97 %	114 %

<sup>(1)</sup> 'Special-use' tyres (see section 2.1.3. of Annex II) should be tested at a speed equal to 85 % of the test-drum speed prescribed above for equivalent normal tyres.

## Appendix 8

## VARIATION OF LOAD CAPACITY WITH SPEED

## Commercial-vehicle tyres

## RADIAL AND DIAGONAL

(see Annex II, sections 2.30, 2.31 and 6.2.4)

Speed (km/h)	Variation of load capacity (%)													
	All load indices						Load indices (°) ≥ 122						Load indices (°) ≤ 121	
	Speed category symbol						Speed category symbol			Speed category symbol			Speed category symbol	
	F	G	J	K	L	M	L	M	L	M	L	M	N	P (°)
0	+ 150	+ 150	+ 150	+ 150	+ 150	+ 150	+ 150	+ 150	+ 150	+ 150	+ 150	+ 150	+ 110	+ 110
5	+ 110	+ 110	+ 110	+ 110	+ 110	+ 110	+ 110	+ 110	+ 110	+ 110	+ 110	+ 110	+ 90	+ 90
10	+ 80	+ 80	+ 80	+ 80	+ 80	+ 80	+ 80	+ 80	+ 80	+ 80	+ 80	+ 80	+ 75	+ 75
15	+ 65	+ 65	+ 65	+ 65	+ 65	+ 65	+ 65	+ 65	+ 65	+ 65	+ 65	+ 65	+ 60	+ 60
20	+ 50	+ 50	+ 50	+ 50	+ 50	+ 50	+ 50	+ 50	+ 50	+ 50	+ 50	+ 50	+ 50	+ 50
25	+ 35	+ 35	+ 35	+ 35	+ 35	+ 35	+ 35	+ 35	+ 35	+ 35	+ 35	+ 35	+ 42	+ 42
30	+ 25	+ 25	+ 25	+ 25	+ 25	+ 25	+ 25	+ 25	+ 25	+ 25	+ 25	+ 25	+ 35	+ 35
35	+ 19	+ 19	+ 19	+ 19	+ 19	+ 19	+ 19	+ 19	+ 19	+ 19	+ 19	+ 19	+ 29	+ 29
40	+ 15	+ 15	+ 15	+ 15	+ 15	+ 15	+ 15	+ 15	+ 15	+ 15	+ 15	+ 15	+ 25	+ 25
45	+ 13	+ 13	+ 13	+ 13	+ 13	+ 13	+ 13	+ 13	+ 13	+ 13	+ 13	+ 13	+ 22	+ 22
50	+ 12	+ 12	+ 12	+ 12	+ 12	+ 12	+ 12	+ 12	+ 12	+ 12	+ 12	+ 12	+ 20	+ 20
55	+ 11	+ 11	+ 11	+ 11	+ 11	+ 11	+ 11	+ 11	+ 11	+ 11	+ 11	+ 11	+ 17,5	+ 17,5
60	+ 10	+ 10	+ 10	+ 10	+ 10	+ 10	+ 10	+ 10	+ 10	+ 10	+ 10	+ 10	+ 15,0	+ 15,0
65	+ 7,5	+ 8,5	+ 8,5	+ 8,5	+ 8,5	+ 8,5	+ 8,5	+ 8,5	+ 8,5	+ 8,5	+ 8,5	+ 8,5	+ 13,5	+ 13,5
70	+ 5,0	+ 7,0	+ 7,0	+ 7,0	+ 7,0	+ 7,0	+ 7,0	+ 7,0	+ 7,0	+ 7,0	+ 7,0	+ 7,0	+ 12,5	+ 12,5
75	+ 2,5	+ 5,5	+ 5,5	+ 5,5	+ 5,5	+ 5,5	+ 5,5	+ 5,5	+ 5,5	+ 5,5	+ 5,5	+ 5,5	+ 11,0	+ 11,0
80	0	+ 4,0	+ 4,0	+ 4,0	+ 4,0	+ 4,0	+ 4,0	+ 4,0	+ 4,0	+ 4,0	+ 4,0	+ 4,0	+ 10,0	+ 10,0
85	- 3	+ 2,0	+ 3,0	+ 3,0	+ 3,0	+ 3,0	+ 3,0	+ 3,0	+ 3,0	+ 3,0	+ 3,0	+ 3,0	+ 8,5	+ 8,5





Speed (km/h)	Variation of load capacity (%)													
	All load indices						Load indices <sup>(1)</sup> ≥ 122						Load indices <sup>(1)</sup> ≤ 121	
	Speed category symbol						Speed category symbol						Speed category symbol	
	F	G	J	K	L	M	L	M	L	M	L	M	N	P <sup>(2)</sup>
90	- 6	0	+ 2,0	+ 2,0	+ 2,0	+ 2,0	+ 2,0	+ 2,0	+ 2,0	+ 2,0	+ 2,0	+ 7,5	+ 7,5	+ 7,5
95	- 10	- 2,5	+ 1,0	+ 1,0	+ 1,0	+ 1,0	+ 1,0	+ 1,0	+ 1,0	+ 1,0	+ 1,0	+ 6,5	+ 6,5	+ 6,5
100	- 15	- 5	0	0	0	0	0	0	0	0	0	+ 5,0	+ 5,0	+ 5,0
105		- 8	- 2	0	0	0	0	0	0	0	0	+ 3,75	+ 3,75	+ 3,75
110		- 13	- 4	0	0	0	0	0	0	0	0	+ 2,5	+ 2,5	+ 2,5
115			- 7	- 3	0	0	0	0	0	0	0	+ 1,25	+ 1,25	+ 1,25
120			- 12	- 7	0	0	0	0	0	0	0	0	0	0
125					0	0	0	0	0	0	0	- 2,5	0	0
130						0	0	0	0	0	0	- 5	0	0
135												- 7,5	- 2,5	0
140												- 10	- 5	0
145												- 7,5	- 7,5	0
150												- 10	- 5	0
155												- 7,5	- 7,5	- 2,5
160												- 10	- 5	- 5

<sup>(1)</sup> The load capacity indices refer to single operations (see section 2.28.2 of Annex II).

<sup>(2)</sup> Load variations are not allowed above 160 km/h. For speed category symbols Q and above, the speed category corresponding to the speed category symbol (see section 2.29.3 of Annex II) specifies the maximum speed permitted for the tyre.



ANNEX III

**ADMINISTRATIVE PROVISIONS FOR THE TYPE-APPROVAL OF VEHICLES WITH REGARD TO THE FITTING OF THEIR TYRES**

1. APPLICATION FOR THE ►**M1** EC TYPE-APPROVAL ◀ OF A VEHICLE TYPE
  - 1.1. The application for ►**M1** EC type-approval ◀ of a vehicle type with regard to its tyres is submitted by the vehicle manufacturer or by his authorized representative.
  - 1.2. It is accompanied, in triplicate, by a description of the vehicle type and of its tyres in terms of their tyre-size designation, speed category and load-capacity index, including any temporary-use spare unit(s), with which it may be fitted as described in the information document in Appendix 1.
  - 1.3. A vehicle representative of the vehicle type to be approved must be submitted to the technical service responsible for conducting the approval tests.
  - 1.4. The vehicle manufacturer or his representative may apply for the ►**M1** EC type-approval ◀ to be extended to include tyres of additional tyre-size designations, speed categories or load-capacity indices or additional temporary-use spare unit(s).
2. ►**M1** EC TYPE-APPROVAL ◀ OF A VEHICLE
  - 2.1. ►**M1** EC type-approval ◀ is granted and an ►**M1** EC type-approval ◀ number issued in respect of any vehicle type submitted in accordance with section 1 which satisfied the requirements of this Directive.
  - 2.2. Notice of approval or of extension or of refusal of approval of a vehicle type pursuant to this Directive is communicated to the Member States by means of a form conforming to the model in Appendix 2.
  - 2.3. An approval number is assigned to each vehicle type approved. The same Member State must not assign the same number to another vehicle type.
3. MODIFICATION OF VEHICLE TYPE
  - 3.1. Every modification of a vehicle type must be notified to the approval authority which approved it. That approval authority may then either:
    - 3.1.1. consider that the modifications made are unlikely to have an appreciable adverse effect and that in any case the vehicle still meets the requirements; or
    - 3.1.2. refuse to approve the modification.
  - 3.2. Confirmation or refusal of approval, specifying the alterations, is communicated to the other Member States by the procedure specified in sections 2.2.
4. CONFORMITY OF PRODUCTION
  - 4.1. Every production vehicle to which this Directive applies must be so manufactured that it conforms to all of the relevant requirements of this Directive.
  - 4.2. In order to verify that the requirements of section 4.1 are met, suitable controls of the production must be carried out.
  - 4.3. The holder of the approval must in particular ensure the existence of procedures for effectively checking on compatibility between the characteristics of the vehicle and the characteristics of the tyres fitted as laid down within the framework of this Directive.
  - 4.4. The approval authority which has granted type-approval may at any time verify the conformity control methods applicable to each production unit.
    - 4.4.1. In every inspection, the test books and productions survey records must be presented to the visiting inspector.
    - 4.5. The normal frequency of inspections authorized by the approval authority in one per year. In the case where negative results are recorded during one of these visits, the approval authority must ensure that all necessary steps are taken to re-establish the conformity of production as rapidly as possible.

**▼B**

## 5. PRODUCTION DEFINITELY DISCONTINUED

If the holder of an approval completely ceases to manufacture a type of vehicle approved in accordance with this Directive, he must so inform the authority which granted the approval. Upon receiving the relevant communication that authority must inform thereof the other approval authorities by means of a copy of the approval form bearing at the end, in large letters, the signed and dated annotation 'PRODUCTION DISCONTINUED'.

▼B

## Appendix 1

## INFORMATION DOCUMENT No...

IN ACCORDANCE WITH ANNEX I TO COUNCIL DIRECTIVE 70/156/EEC RELATING TO  
►M1 EC TYPE-APPROVAL ◀ OF A VEHICLE TYPE WITH REGARD TO THE FITTING  
OF ITS TYRES

(DIRECTIVE 92/23/EEC)

The following information, if applicable, must be supplied in triplicate and must include a list of contents. Drawings, if any, must be supplied in appropriate scale and in sufficient detail on size A4 or folded to that size. In the case of microprocessor-controlled functions supply relevant performance-related information.

0. GENERAL
- 0.1. Make (trade name of manufacturer): .....
- 0.2. Type and commercial description(s): .....
- 0.3. Means of identification of type, if marked on the vehicle (b): .....
- 0.3.1. Location of that marking: .....
- 0.4. Category of vehicle (c): .....
- 0.5. Name and address of applicant: .....
- 0.6. Location of statutory plates and inscriptions and methods of affixing: .....
- 0.6.1. On the chassis: .....
- 0.6.2. On the bodywork: .....
- 0.7. Address(es) of assembly plant(s): .....
1. GENERAL CONSTRUCTION CHARACTERISTICS OF THE VEHICLE
- 1.3. Number of axles and wheels: .....
- 1.3.1. Number and position of axles with tyres in dual (twin) formation: .....
- 1.3.2. Number and position of steered axles: .....
- 1.3.3. Powered axles (number, position, interconnection): .....
- 1.4. Maximum design speed (for each variant, if any): .....
2. MASSES AND DIMENSIONS (e) (in kg and mm) (refer to drawing where applicable)
- 2.1. Maximum technically permissible mass for each axle: .....
6. SUSPENSION:
- 6.2. Tyres and wheels normally fitted: .....
- 6.2.1. Attached is a list presented by the vehicle manufacturer of all the relevant variants (if any) of the vehicle type and the corresponding tyres for use on each. The description of the tyres must include the following information:
- the tyre-size designation,
  - the minimum load-capacity index compatible with the maximum axle load (each axle to be stated separately if more than one tyre size designation is fitted to the vehicle),
  - the minimum speed category symbol compatible with the maximum design speed.
- 6.2.4. Tyre pressure(s) as recommended by the vehicle manufacturer (kPa): .....
- 6.2.5. Tyre/wheel combination(s): .....
- 6.2.6. Brief description of temporary-use spare unit(s), if any: .....

Note: Footnotes, see Annex to Directive 70/156/EEC, as last amended by Directive 87/403/EEC.

▼ **B**

## Appendix 2

MODEL

[(maximum format: A4 (210 × 297 mm))]

► **M1** EC TYPE-APPROVAL ◀ **CERTIFICATE**

(vehicle)

Stamp of  
Administration

Communication concerning the:

- type-approval <sup>(1)</sup>,
- extension of type-approval <sup>(1)</sup>,
- refusal of type-approval <sup>(1)</sup>,

of a type of vehicle with regard to Directive 92/23/EEC.

► <sup>(1)</sup>EC type-approval ◀ No: ..... Extension No: .....

## SECTION I

0. **General**
- 0.1. **Make (trade name of manufacturer):** .....
- 0.2. **Commercial description(s):** .....
- 0.3. **Means of identification of type, if marked on the vehicle (b):** .....
- 0.3.1. **Location of that marking:** .....
- 0.4. **Category of vehicle (c):** .....
- 0.5. **Name and address of applicant:** .....
- 0.6. **Location of statutory plates and inscriptions and methods of affixing:** .....
- 0.6.1. **On the chassis:** .....
- 0.6.2. **On the bodywork:** .....
- 0.7. **Address(es) of assembly plant (s):** .....

<sup>(1)</sup> Delete where inapplicable.

Footnotes, see Annex to Directive 70/156/EEC, as last amended by Directive 87/403/EEC.

▼B

## SECTION II

1. **Additional information**
- 1.1. Attached is a list presented by the vehicle manufacturer of all the relevant variants (if any) of the vehicle type and the corresponding tyres for use on each. The description of the tyres must include only the following information:
- the tyre size designation,
  - the minimum speed category symbol compatible with the maximum design speed,
  - the minimum load-capacity index compatible with the maximum axle load (each axle to be stated separately if more than one tyre size designation is fitted to the vehicle).
- 1.2. Brief description of temporary-use spare unit(s), if any: .....
- 1.2.1. Technical service responsible for carrying out the tests: .....
- 1.2.2. Date of test report: .....
- 1.2.3. Number of test report: .....
- 1.2.4. Grounds for extending EC type-approval (where appropriate): .....
- 1.2.5. Comments (if any): .....
- 1.2.6. Place: .....
- 1.2.7. Date: .....
- 1.2.8. Signature: .....
- 1.2.9. A list of documents making up the type-approval file lodged with the approval authority that has granted type-approval, which may be obtained on request, is attached.



ANNEX IV

**REQUIREMENTS FOR VEHICLES WITH REGARD TO THE FITTING OF THEIR TYRES**

1. DEFINITIONS
2. For the purpose of this Directive:
  - 2.1. *'approval of a vehicle'* means the approval of a vehicle type with regard to its tyres, including temporary-use spare tyres;
  - 2.2. *'vehicle type'* means a range of vehicles which do not differ significantly, at least as regards each variant of the vehicle type, in such essential aspects as would affect the tyre size designation, the speed category symbol or the load capacity index;
  - 2.3. *'wheel'* means a complete wheel consisting of a rim and a wheel disc;
  - 2.4. *'temporary-use spare wheel'* means a wheel different from one of the normal wheels on the vehicle type;
  - 2.5. *'unit'* means an assembly of a wheel and tyre;
  - 2.6. *'normal unit'* means a unit which is capable of being fitted to the vehicle for normal operation;
  - 2.7. *'spare unit'* means a unit which is intended to be exchanged for a normal unit in case of malfunction of the latter. A *'spare unit'* may be either of the following:
    - 2.7.0. *'normal spare unit'*, which is a unit that conforms to the normal unit of the vehicle type;
    - 2.7.1. *'temporary-use spare unit'*, which is a unit that differs from the normal units of the vehicle type with regard to their principal characteristics (e.g. their tyre-size designation, functional dimensions, conditions of use or structure). It is intended for temporary use under restricted conditions. Temporary-use spare units may be of the following categories:
      - 2.7.1.1. category 1
 

a unit consisting of a wheel which conforms to a wheel of a normal unit and a tyre which has principal characteristics (e.g. dimensions, structure) different to the normal tyre;
      - 2.7.1.2. category 2
 

a unit consisting of a wheel and a tyre both having principal characteristics different to the normal unit and intended to be carried on the vehicle with the tyre inflated to the pressure specified for temporary use;
      - 2.7.1.3. category 3
 

a unit consisting of a normal wheel and a tyre having principal characteristics different to a normal tyre and intended to be carried on the vehicle with the tyre folded and not inflated;
      - 2.7.1.4. category 4
 

a unit consisting of a wheel and tyre both having principal characteristics different to a normal unit and intended to be carried on the vehicle with the tyre folded and not inflated;
  - 2.8. *'maximum mass'* means the maximum value stated by the vehicle manufacturer to be technically permissible for the vehicle;
  - 2.9. *'maximum axle load'* means the maximum value stated by the vehicle manufacturer to be technically permissible for the total vertical force between the contact surfaces of the tyres of the axle in question and the ground and resulting from the part of the vehicle mass supported by that axle. The sum of the axle loads may be greater than the value corresponding to the maximum mass of the vehicle;
  - 2.10. *'functional dimensions'* means dimensions derived from the size designation of the wheels and/or tyres (e.g. diameter, width, aspect ratio) and from the mounting of the unit to the vehicle (e.g. wheel offset);

**▼B**

2.11. 'maximum design speed' means the maximum speed approved for the vehicle type inclusive of the tolerance allowed for the conformity checks of the series production.

3. REQUIREMENTS FOR VEHICLES WITH REGARD TO THE FITTING OF THEIR TYRES

3.1. **General**

**▼M1**

3.1.1. Subject to the provisions of section 3.7.4., every tyre fitted to a vehicle, including where applicable any spare, must bear the EC type-approval mark(s) as specified in section 4 of Annex I or the type-approval mark indicating compliance with UN/ECE Regulations Nos 30 or 54. UN/ECE type-approval marks are considered to be equivalent only to the EC type-approval marks granted pursuant to Annex II.

**▼B**

3.2. **Tyre fitment**

- 3.2.1. All of the tyres fitted to a vehicle, excluding any temporary use spare, must have the same structure (see Annex II section 2.3).
- 3.2.2. All of the tyres fitted to one axle must be of the same type (see Annex II section 2.1).
- 3.2.3. The space in which the wheel revolves must be such as to allow unrestricted movement when using the maximum permissible size of tyres within the suspension and steering constraints provided by the vehicle manufacturer.

3.3. **Load capacity**

- 3.3.1. Subject to the provisions of section 3.7, the maximum load rating (see Annex II section 2.31) of every tyre, including a spare tyre (if provided) with which a vehicle is fitted is:
- 3.3.1.1. in the case of a vehicle fitted with tyres of the same type in single formation: at least equal to half of the maximum axle load (see section 2.9) for the most heavily loaded axle, as declared by the manufacturer of the vehicle;
- 3.3.1.2. in the case of a vehicle fitted with tyres of more than one type, in single formation: at least equal to half of the maximum axle load (see section 2.9), as declared by the manufacturer of the vehicle, in respect of the relevant axle;
- 3.3.1.3. in the case of a vehicle fitted with passenger car tyres in dual (twin) formation: at least equal to 0,27 times the maximum axle load, as declared by the manufacturer of the vehicle, in respect of the relevant axle;
- 3.3.1.4. in the case of axles fitted with commercial vehicle tyres in dual (twin) formation: at least equal to 0,25 times, with reference to the load capacity index for dual application, the maximum axle load as declared by the manufacturer of the vehicle, in respect of the relevant axle.

3.4. **Speed capacity**

- 3.4.1. Every tyre with which a vehicle is normally fitted must have a speed category symbol (see Annex II section 2.29) compatible with the maximum design speed of the vehicle (as declared by the vehicle manufacturer) or the applicable load/speed combination (see Annex II section 2.30).
- 3.4.2. The above specification does not apply:
- 3.4.2.1. in the case of temporary use spare units for which section 3.8 applies;
- 3.4.2.2. in the case of vehicles normally equipped with ordinary tyres and occasionally supplied with snow tyres.

However, in this case the speed category symbol of the snow tyres must correspond to a speed either greater than the maximum design speed of the vehicle (as declared by the vehicle manufacturer) or not less than 160 km/h (or both).

If, nevertheless, the maximum design speed of the vehicles (as declared by the vehicle manufacturer) is greater than the speed corresponding to the speed category symbol of the snow tyres a maximum speed warning label, specifying the maximum speed capability of the snow tyres, must



**▼B**

be displayed inside the vehicle in a prominent position readily visible to the driver.

**3.5. Spare tyre**

3.5.1. In the case where a vehicle is provided with a spare wheel its tyre must be:

3.5.1.1. the same type as one of the tyres fitted to or approved for the vehicle, or

3.5.1.2. a temporary-use spare tyre of a type suitable for use on the vehicle, in any position. However, no vehicle other than a vehicle of category  $M_1$  may be fitted with a temporary-use spare tyre.

3.5.2. Every vehicle provided with a temporary-use spare unit must be provided with supplementary information clearly and permanently displayed on the temporary-use spare unit or on the vehicle near the spare unit or in the driver's handbook. At least the following information must be given:

3.5.2.1. an instruction to drive with caution when the temporary-use spare unit is fitted, and to install a normal unit as soon as possible;

3.5.2.2. a statement that operation of the vehicle is not permitted with more than one temporary-use spare unit fitted at the same time;

3.5.2.3. a clear indication of the inflation pressure specified by the vehicle manufacturer for the tyre of the temporary-use spare unit;

3.5.2.4. for vehicles equipped with category 3 or category 4 temporary-use spare units, a description of the procedure for inflating the tyre to the pressure specified for temporary use by means of the device referred to in section 3.6;

**3.6. Inflating device of temporary-use spare unit:**

3.6.1. if the vehicle is equipped with a category 3 or category 4 temporary-use spare unit, a device must be provided on the vehicle which permits the tyre to be inflated to the pressure specified for temporary use within a maximum of five minutes.

**3.7. Special cases**

3.7.1. In the case of trailers of categories 01 and 02 with operating speeds restricted to 100 km/h or less fitted with passenger car tyres in single formation, the maximum load rating of every tyre must be at least equal to 0,45 times the maximum mass for the most heavily loaded axle, as declared by the manufacturer of the trailer. For tyres in dual (twin) formation this factor is 0,24.

3.7.2. In the case of some special vehicles fitted with commercial vehicle tyres, the table 'Variation of Load Capacity with Speed' (see section 2.30 and Appendix 8 to Annex II) is not to be applied. In those cases the tyre maximum load ratings to check against the maximum axle loads (see sections 3.3.1.2 and 3.3.1.4 of this Annex) are determined by multiplying the load corresponding to the load capacity index by an appropriate coefficient which is related to the type of vehicle and its use rather than to the maximum design speed of the vehicle. In such cases section 3.4.1 of this Annex does not apply. The appropriate coefficients are as follows:

3.7.2.1. 1,10 in the case of vehicles of category  $M_3$  when the vehicle is carrying standing passengers and the operating speed does not exceed 60 km/h. However, for operational reasons Member States may allow the operating speed to be increased to 80 km/h;

3.7.2.2. 1,15 in the case of such vehicles ( $M_3$ ) if they are intended for use only on urban routes with frequent stops;

3.7.2.3. 1,10 in the case of public utility vehicles of category N used at slow speeds over short distances in urban and suburban applications such as road sweepers or refuse collectors.

3.7.3. When a motor vehicle of category  $M_1$  is towing a trailer, the additional load imposed at the trailer coupling device may cause the tyre maximum load ratings to be exceeded, but not by more than 15 %, provided that the operating speed is restricted to 100 km/h or less and the inflation pressure increased by at least 0,2 bar is applied.

3.7.4. In the case of a vehicle which is fitted with tyres which are not passenger car tyres nor commercial vehicle tyres due to special conditions of use (e.g. agricultural tyres, industrial truck tyres, motor

**▼B**

cycle tyres) the requirements of Annex II do not apply provided that the approval authority is satisfied that the tyres fitted are suitable for the operating conditions of the vehicle.

**3.8. Specifications for temporary-use spare units**

- 3.8.1. Every temporary-use spare tyre must have a speed category at least equal to 120 km/h (speed category symbol L).
- 3.8.2. When fitted to the vehicle for temporary use the outward facing surface of the wheel must exhibit a distinctive colour or colour pattern which is clearly different from the colour(s) of the normal units. If it is possible to attach a wheel cover to the temporary-use spare unit the distinctive colour or colour pattern must not be obscured by this wheel cover.
- 3.8.3. A maximum speed warning symbol must be permanently displayed on the outer face of the wheel in a prominent position and in accordance with the diagram below:

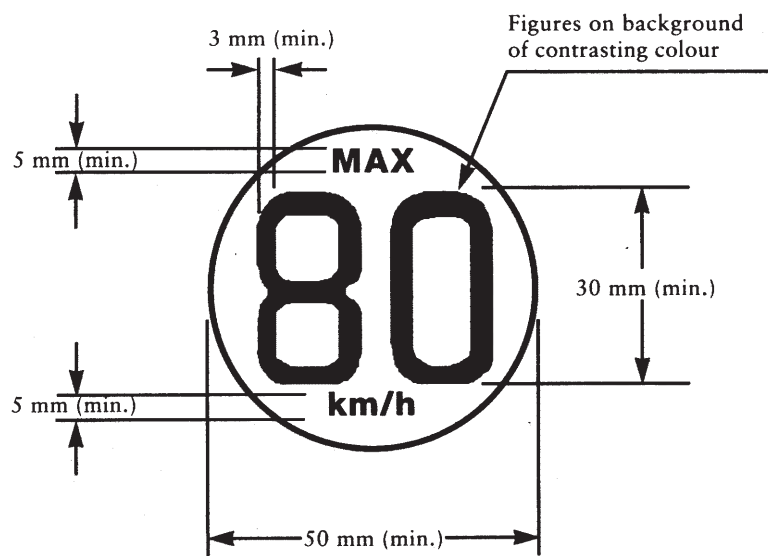

Scale – full size (1:1)

▼ **M1**

## ANNEX V

**TYRE/ROAD NOISE EMISSION**

## 1. SCOPE

This annex applies to the EC type-approval of tyres, as components, in respect of tyre/road noise emissions.

## 2. DEFINITIONS

For the purposes of this Annex, the definitions of Annex II shall apply, except for the definition under section 2.1., which shall read as follows:

## 2.1. 'Type of tyre'

means, in relation to type-approval pursuant to this Annex (tyre/road noise emission), a range of tyres consisting of a list of tyre size designations (see section 2.17 in Annex II), brand names, trade marks and trade descriptions which do not differ in such essential characteristics as:

- the manufacturer's name
- the tyre classification (see section 2.4. of this Annex)
- the tyre structure (see section 2.1.4. of Annex II)
- the category of use (see section 2.1.3. of Annex II)
- for class C1 tyres. Reinforced or Extra Load
- the tread pattern (see 2.3 of Information Document, Annex I, Appendix 3).

*Note:* The effect of changes in minor details of tyre tread and construction on the tyre/road noise emission will be determined during checks on the conformity of production.

In addition, the following definitions shall also apply:

## 2.2. 'Brand name or trade description'

means the identification for the tyre as provided by the tyre manufacturer. The brand name may be the same as the manufacturer and the trade description may coincide with the trade mark.

## 2.3. 'Tyre/road noise emission'

means the noise arising from the contact between tyres in motion and the road surface.

## 2.4. For the purpose of this Annex, the following classification shall apply:

- class C1 tyres passenger car tyres (see section 2.32. of Annex II);
- class C2 tyres commercial vehicle tyres (see section 2.33. of Annex II) with load capacity index in single formation  $\leq 121$  and speed category symbol  $\geq$  'N' (see section 2.29.3. of Annex II);
- class C3 tyres commercial vehicle tyres (see section 2.33. of Annex II) with load capacity index in single formation  $\leq 121$  and speed category symbol  $\leq$  'M' (see section 2.29.3. of Annex II) or commercial vehicle tyres (see section 2.33. of Annex II) with load capacity index in single formation  $\geq 122$ .

## 3. MARKING REQUIREMENTS

## 3.1. In addition to other marking requirements given in section 4 of Annex I and section 3 of Annex II, the tyre must bear the following markings:

## 3.1.1. the manufacturer's name or trade mark; the brand name, the trade description or the trade mark.

## 4. TYRE/ROAD NOISE EMISSION REQUIREMENTS

## 4.1. General requirements

A set of four tyres bearing the same tyre size designation and tread pattern that is representative of the range of tyres, shall be submitted to a tyre/road noise emission level test to be carried out as specified in Appendix 1.

▼ **M1**

- 4.2. The noise levels determined in accordance with section 4.5 of Appendix 1 shall not exceed the following limits:
- 4.2.1. Class C1 tyres, with reference to the nominal section width (see Annex II, section 2.17.1.1.) of the tyre that has been tested:

Tyre Class	Nominal section width (mm)	Limit values in dB(A)		
		A	B <sup>(1)</sup>	C <sup>(1)</sup> <sup>(2)</sup>
C1a	≤ 145	72 (*)	71 (*)	70
C1b	> 145 ≤ 165	73 (*)	72 (*)	71
C1c	> 165 ≤ 185	74 (*)	73 (*)	72
C1d	> 185 ≤ 215	75 (**)	74 (**)	74
C1e	> 215	76 (***)	75 (***)	75

(\*) Limit values in column A shall apply until 30 June 2007;

Limit values in column B shall apply as from 1 July 2007.

(\*\*) Limit values in column A shall apply until 30 June 2008;

Limit values in column B shall apply as from 1 July 2008.

(\*\*\*) Limit values in column A shall apply until 30 June 2009;

Limit values in column B shall apply as from 1 July 2009.

<sup>(1)</sup> Indicative figures only. Definitive figures will depend on amendment of the Directive following the report required in Article 3(2) of Directive 2001/43/EC.

<sup>(2)</sup> Limit values for column C will result from the amendment of the Directive following the report required in Article 3(2) of Directive 2001/43/EC.

- 4.2.1.1. For reinforced (or Extra Load) tyres (see Annex II, section 3.1.8.), the limit values in section 4.2.1. shall be increased by 1 dB(A)
- 4.2.1.2. For tyres classified in category of use 'Special', (see Annex II, section 2.1.3.), the limit values in section 4.2.1. shall be increased by 2 dB(A).
- 4.2.2. Class C2 tyres with reference to the category of use (see Annex II, section 2.1.3.) of the range of tyres:

Category of use	Limit value expressed in dB(A)
Normal	75
Snow	77
Special	78

- 4.2.3. Class C3 tyres, with reference to the category of use (see Annex II, section 2.1.3.) of the range of tyres:

Category of use	Limit value expressed in dB(A)
Normal	76
Snow	78
Special	79

▼ **M1***Appendix 1***TEST METHOD FOR TYRE-ROAD SOUND LEVELS COAST-BY METHOD****0. Introduction**

The presented method contains specifications on measuring instruments, measurement conditions and the measurement method, in order to obtain the noise level of a set of tyres mounted on a test vehicle rolling at high speed on a specified road surface. The maximum sound pressure level is to be recorded, when the test vehicle is coasting, by remote-field microphones; the final result of a reference speed is obtained from a linear regression analysis. Such test results cannot be related to tyre noise measured during acceleration under power or deceleration during braking.

**1. Measuring instruments****1.1. Acoustic measurements**

The sound level meter or the equivalent measuring system, including the windscreen recommended by the manufacturer, shall at least meet the requirements of Type 1 instruments in accordance with IEC 60651, second edition.

The measurements shall be made using the frequency weighting A, and the time weighting F.

When using a system that includes a periodic monitoring of the A-weighted sound level, a reading should be made at a time interval not greater than 30 ms.

**1.1.1. Calibration**

At the beginning and at the end of every measurement session, the entire measurement system shall be checked by means of a sound calibrator that fulfils the requirements for sound calibrators of at least precision Class 1 according to IEC 942:1988. Without any further adjustment the difference between the readings of two consecutive checks shall be less than or equal to IEC 942:1988. Without any further adjustment the difference between the readings of two consecutive checks shall be less than or equal to 0,5 dB. If this value is exceeded, the results of the measurements obtained after the previous satisfactory check shall be discarded.

**1.1.2. Compliance with requirements**

The compliance of the sound calibration device with the requirements of IEC 60942:1988 shall be verified once a year and the compliance of the instrumentation system with the requirements of IEC 60651:1979/A1:1993, second edition, shall be verified at least every two years by a laboratory which is authorised to perform calibrations traceable to the appropriate standards.

**1.1.3. Positioning of the microphone**

The microphone (or microphones) must be located at a distance of  $7,5 \text{ m} \pm 0,05 \text{ m}$  from track reference line CC' (*figure 1*) and  $1,2 \text{ m} \pm 0,02 \text{ m}$  above the ground. Its axis of maximum sensitivity must be horizontal and perpendicular to the path of the vehicle (line CC').

**1.2. Speed measurements**

The vehicle speed shall be measured with instruments with an accuracy of  $\pm 1 \text{ km/h}$  or better when the front end of the vehicle has reached line PP' (*figure 1*).

**1.3. Temperature measurements**

Measurements of air as well as test surface temperature are mandatory. The temperature measuring devices shall be accurate within  $\pm 1 \text{ }^\circ\text{C}$ .

**1.3.1. Air temperature**

The temperature sensor is to be positioned in an unobstructed location close to the microphone in such a way that it is exposed to the airflow and protected from direct solar radiation. The latter may be achieved by any shading screen or similar device. The sensor should be positioned at a height of  $1,2 \text{ m} \pm 0,1 \text{ m}$  above the test surface level in order to minimise the influence of the test surface thermal radiation at low airflows.

▼ **M1**1.3.2. *Test surface temperature*

The temperature sensor is to be positioned in a location where the temperature measured is representative of the temperature in the wheel tracks, without interfering with the sound measurement.

If an instrument with a contact temperature sensor is used, heat-conductive paste shall be applied between the surface and the sensor to ensure adequate thermal contact.

If a radiation thermometer (pyrometer) is used, the height should be chosen to ensure that a measuring spot with a diameter of  $\geq 0,1$  m is covered.

## 1.4. Wind measurement

The device must be capable of measuring the wind speed with a tolerance of  $\pm 1$  m/s. The wind shall be measured at microphone height. The wind direction with reference to the driving direction shall be recorded.

2. **Conditions of measurement**

## 2.1. Test site

The test site must consist of a central section surrounded by a substantially flat test area. The measuring section must be level; the test surface must be dry and clean for all measurements. The test surface shall not be artificially cooled during or prior to the testing.

The test track must be such that the conditions of a free sound field between the sound source and the microphone are attained to within 1 dB(A). These conditions shall be deemed to be met if there are no large sound reflecting objects such as fences, rocks, bridges or buildings within 50 m of the centre of the measuring section. The surface of the test track and the dimensions of the test site shall be in accordance with Appendix 2 of this Annex.

A central part of at least 10 m radius shall be free of powdery snow, tall grass, loose soil, cinders or the like. There must be no obstacle which could affect the sound field within the vicinity of the microphone and no persons shall stand between the microphone and the sound source. The operator carrying out the measurements and any observers attending the measurements must position themselves so as not to affect the readings of the measuring instruments.

## 2.2. Meteorological conditions

Measurements shall not be made under poor atmospheric conditions. It must be ensured that the results are not affected by gusts of wind. Testing shall not be performed if the wind speed at the microphone height exceeds 5 m/s.

Measurements shall not be made if the air temperature is below 5 °C or above 40 °C or the test surface temperature is below 5 °C or above 50 °C.

## 2.3. Ambient noise

The background sound level (including any wind noise) shall be at least 10 dB(A) less than the measured tyre-road sound emission. A suitable windscreen may be fitted to the microphone provided that account is taken of its effect on the sensitivity and directional characteristics of the microphone.

Any measurement affected by a sound peak which appears to be unrelated to the characteristics of the general sound level of tyres shall be ignored.

## 2.4. Test vehicle requirements

2.4.1. *General*

The test vehicle shall be a motor vehicle and be fitted with four single tyres on just two axles.

2.4.2. *Vehicle load*

The vehicle must be loaded such as to comply with the test tyre loads as specified in section 2.5.2. below.

▼ **M1**2.4.3. *Wheelbase*

The wheelbase between the two axles fitted with the test tyres shall for Class C1 be less than 3,50 m and for Class C2 and Class C3 tyres be less than 5 m.

2.4.4. *Measures to minimise vehicle influence on sound level measurements*

To ensure that tyre noise is not significantly affected by the test vehicle design the following requirements and recommendations are given.

Requirements:

- (a) Spray suppression flaps or other extra device to suppress spray shall not be fitted.
- (b) Addition or retention of elements in the immediate vicinity of the rims and tyres, which may screen the emitted sound, is not permitted.
- (c) Wheel alignment (toe in, camber and castor) shall be in full accordance with the vehicle manufacturer's recommendations.
- (d) Additional sound absorbing material may not be mounted in the wheel housings or under the underbody.
- (e) Suspension shall be in such a condition that it does not result in an abnormal reduction in ground clearance when the vehicle is loaded in accordance with the testing requirement. If available, body level regulation systems shall be adjusted to give a ground clearance during testing which is normal for unladen condition.

Recommendations to avoid parasitic sound:

- (a) Removal or modification of components on the vehicle that any contribute to the background sound of the vehicle is recommended. Any removals or modifications shall be recorded in the test report.
- (b) During testing it should be ascertained that brakes are not poorly released, causing brake noise.
- (c) It should be ascertained that electric cooling fans are not operating.
- (d) Windows and sliding roof of the vehicle shall be closed during testing.

## 2.5. Tyres

2.5.1. *General*

Four identical tyres of the same type and range must be fitted to the test vehicle. In the case of tyres with a load capacity index in excess of 121 and without any dual fitting indication, two of these tyres of the same type and range must be fitted to the rear axle of the test vehicle; the front axle must be fitted with tyres of a size suitable for the axle load and planed down to the minimum depth in order to minimise the influence of tyre/road contact noise while maintaining a sufficient level of safety. Winter tyres that in certain Member States may be equipped with studs intended to enhance friction shall be tested without this equipment. Tyres with special fitting requirements shall be tested in accordance with these requirements (e.g. rotation direction). The tyres must have full tread depth before being run-in.

Tyres are to be tested on rims permitted by the tyre manufacturer.

2.5.2. *Tyre loads*

The test load  $Q_t$  for each tyre on the test vehicle shall be 50 % to 90 % of the reference load  $Q_r$ , but the average test load  $Q_{\text{LAV}}$  of all tyres shall be  $75 \% \pm 5 \%$  of the reference load  $Q_r$ .

For all tyres the reference load  $Q_r$  corresponds to the maximum mass associated with the load capacity index of the tyre. In the case where the load capacity index is constituted by two numbers divided by slash (/), reference shall be made to the first number.

▼ **M1**2.5.3. *Tyre inflation pressure*

Each tyre fitted on the test vehicle shall have a test pressure  $P_t$  not higher than the reference pressure  $P_r$  and within the interval:

$$P_r(Q_t/Q_r)^{1,25} \leq P_t \leq 1,1 P_r(Q_t/Q_r)^{1,25}$$

where  $P_r$  is the pressure corresponding to the pressure index marked on the sidewall.

For Class C1 the reference pressure is  $P_r = 250$  kPa for 'standard' tyres and 290 kPa for 'reinforced' tyres, the minimum test pressure shall be  $P_t = 150$  kPa.

2.5.4. *Preparations prior to testing*

The tyres should be 'run-in' prior to testing to remove compound nodules or other tyre pattern characteristics resulting from the moulding process. This will normally require the equivalent of about 100 km of normal use on the road.

The tyres fitted to the test vehicle shall rotate in the same direction as when they were run-in.

Prior to testing tyres shall be warmed up by running under test conditions.

**3. Method of testing**3.1. *General conditions*

For all measurements the vehicle must be driven in a straight line over the measuring section (AA' to BB') in such a way that the median longitudinal plane of the vehicle is as close as possible to the line CC'.

When the front end of the test vehicle has reached the line AA', the vehicle's driver must have put the gear selector on neutral position and switched off the engine. If abnormal noise (e.g. ventilator, self-ignition) is emitted by the test vehicle during the measurement, the test must be repeated.

3.2. *Nature and number of measurements*

The maximum sound level expressed in A-weighted decibels (dB(A)) shall be measured to the first decimal place as the vehicle is coasting between lines AA' and BB' (*figure 1* — front end of the vehicle on line AA', rear end of the vehicle on line BB'). This value will constitute the result of the measurement.

At least four measurements shall be made on each side of the test vehicle at test speeds lower than the reference speed specified in paragraph 4.1. and at least four measurements at test speeds higher than the reference speed. The speeds shall be approximately equally spaced over the speed range specified in paragraph 3.3.

3.3. *Test speeds*

The test vehicle speeds shall be within the range:

- (i) from 70 km/h to 90 km/h for Class C1 and Class C2 tyres;
- (ii) from 60 km/h to 80 km/h for Class C3 tyres.

**4. Interpretation of results**

The measurement shall be invalid if an abnormal discrepancy between the maximum value and the other values is recorded.

4.1. *Determination of test result*

Reference speed  $V_{ref}$  used to determine the final result will be:

- (i) 80 km/h for Class C1 and Class C2 tyres;
- (ii) 70 km/h for Class C3 tyres.



▼ **M1**

## 4.2. Regression analysis of noise measurements

The (not temperature corrected) tyre-road noise level  $L_R$  in dB(A) is determined by a regression analysis according to:

$$L_R = \bar{L} - a \cdot \bar{v}$$

where:

$$\bar{L}$$

is the mean value of the noise levels  $L_i$ , measured in dB(A):

$$\bar{L} = \frac{1}{n} \sum_{i=1}^n L_i$$

$n$  is the measurement number ( $n \geq 16$ ),

$$\bar{v}$$

is the mean value of logarithms of speeds  $v_i$ :

$$\bar{v} = \frac{1}{n} \sum_{i=1}^n v_i$$

With

$$v_i = \lg(v_i / v_{ref})$$

$a$  is the slope of the regression line in dB(A):

$$a = \frac{\sum_{i=1}^n (v_i - \bar{v})(L_i - \bar{L})}{\sum_{i=1}^n (v_i - \bar{v})^2}$$

## 4.3. Temperature correction

For Class C2 tyres, the final result shall be normalised to a test surface reference temperature  $\theta_{ref}$  by applying a temperature correction, according to the following:

$$L_{R}(\theta_{ref}) = L_{R}(\theta) + K(\theta_{ref} - \theta)$$

where  $\theta$  is the measured test surface temperature,

$$\theta_{ref} = 20 \text{ }^{\circ}\text{C},$$

For Class C1 tyres, the coefficient  $K$  is  $-0,03 \text{ dB(A)/}^{\circ}\text{C}$  when  $\theta > \theta_{ref}$  and  $K$  is  $-0,06 \text{ dB(A)/}^{\circ}\text{C}$  when  $\theta < \theta_{ref}$ .

For Class C2 tyres, the coefficient  $K$  is  $-0,02 \text{ dB(A)/}^{\circ}\text{C}$

If the measured test surface temperature does not change by more than  $5 \text{ }^{\circ}\text{C}$  within all measurements necessary for the determination of the sound level of one set of tyres, the temperature correction may be made

**▼ M1**

only on the final reported tyre-road sound level as indicated above, utilizing the arithmetic mean value of the measured temperatures. Otherwise each measured sound level  $L_i$  shall be corrected, utilizing the temperature at the time of the sound recording.

There will be no temperature correction for Class C3 tyres.

- 4.4. In order to take account of any measuring instrument inaccuracies, the results according to section 4.3. shall be reduced by 1 dB(A).
- 4.5. The final result, the temperature corrected tyre-road noise level  $L_R(\theta_{ref})$  in dB(A), shall be rounded down to the nearest lower whole value.

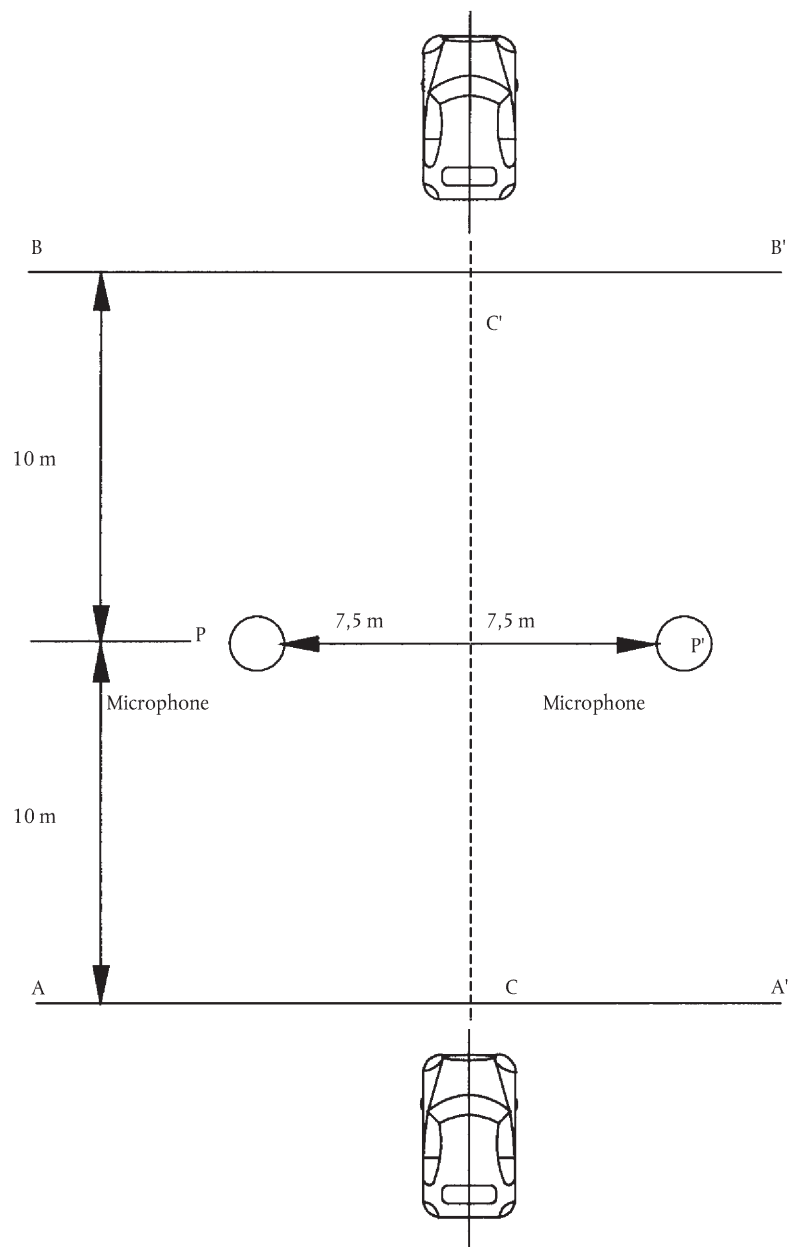
▼ M1*Figure 1:***Microphone Positions for the Measurement**

**▼ M1***Appendix 2***TEST REPORT**

The test report shall include the following information:

- (a) meteorological conditions inclusive of air and test surface temperature for each test run,
- (b) date and method of check on compliance of the test surface with ISO 10844:1994,
- (c) test rim width,
- (d) tyre data: manufacturer, brand name, trade name, size, load index, reference pressure,
- (e) test vehicle description and wheelbase,
- (f) type test load  $Q_t$  in N and in per cent of the reference load  $Q_r$  for each test tyre, average test load  $Q_{t,avr}$  in N and in per cent of the reference load  $Q_r$ ,
- (g) cold inflation pressure in kPa for each test tyre,
- (h) test speeds when the vehicle passed line PP',
- (i) maximum A-weighted sound levels for each test run and each microphone,
- (j) the test result  $L_R$ : A-weighted sound level in decibel at reference speed, corrected for temperature (if applicable), rounded down to the nearest lower whole value.
- (k) regression line slope.

**SPECIFICATIONS FOR THE TEST SITE****1. Introduction**

This annex describes the specifications relating to the physical characteristics and the laying of the test track. These specifications based on a special standard <sup>(1)</sup> describe the required physical characteristics as well as the test methods for these characteristics.

**2. Required characteristics of the surface**

A surface is considered to conform to this standard provided that the texture and voids content or sound absorption coefficient have been measured and found to fulfil all the requirements of sections 2.1. to 2.4. below and provided that the design requirements (section 3.2.) have been met.

**2.1. Residual voids content**

The residual voids content (VC) of the test track paving mixture shall not exceed 8 %. For the measurement procedure, see section 4.1.

**2.2. Sound absorption coefficient**

If the surface fails to comply with the residual voids content requirement, the surface is acceptable only if its sound absorption coefficient  $\alpha \leq 0,10$ . For the measurement procedure, see section 4.2. The requirement of sections 2.1. and 2.2. is also met if only sound absorption has been measured and found to be  $\alpha \leq 0,10$ .

*Note:* The most relevant characteristic is the sound absorption, although the residual voids content is more familiar among road constructors. However, sound absorption needs to be measured only if the surface fails to comply with the voids requirement. This is justified because the residual voids content has relatively large uncertainties in terms of both measurements and relevance and some surfaces may therefore erroneously be rejected when based only on the voids measurement.

**2.3. Texture depth**

The texture depth (TD) measured according to the volumetric method (see section 4.3. below) shall be:

$$TD \geq 0,4 \text{ mm}$$

**2.4. Homogeneity of the surface**

Every practical effort shall be taken to ensure that the surface is made to be as homogeneous as possible within the test area. This includes the texture and voids content, but it should also be observed that if the rolling process results in more effective rolling at some places than others, the texture may be different and unevenness causing bumps may also occur.

**2.5. Period of testing**

In order to check whether the surface continues to conform to the texture and voids content or sound absorption requirements stipulated in this Annex, periodic testing of the surface shall be carried out at the following intervals:

(a) For residual voids content (VC) or sound absorption ( $\alpha$ ):

when the surface is new;

if the surface meets the requirements when new, no further periodical testing is required. If it does not meet the requirement when it is new, it may do so later because surfaces tend to become clogged and compacted with time.

<sup>(1)</sup> ISO 10844:1994 If a different test surface is defined by ISO, in the future, the reference standard will be amended accordingly.

▼ **M1**

(b) For texture depth (TD):

when the surface is new;

when the noise testing starts (*NB*: not before four weeks after laying);

then every twelve months.

### 3. Test surface design

#### 3.1. Area

When designing the test track layout it is important to ensure that, as a minimum requirement, the area traversed by the vehicles running through the test strip is covered with the specified test material with suitable margins for safe and practical driving. This will require that the width of the track is at least 3 m and the length of the track extends beyond lines AA and BB by at least 10 m at either end. Figure 1 shows a plan of a suitable test site and indicates the minimum area which shall be machine laid and machine compacted with the specified test surface material. According to Annex 5, Appendix 1, section 3.2., measurements have to be made on each side of the vehicle. This can be made either by measuring with two microphone locations (one on each side of the track) and driving in one direction, or measuring with a microphone only on one side of the track but driving the vehicle in two directions. If the latter method is used, then there are no surface requirements on that side of the track where there is no microphone.

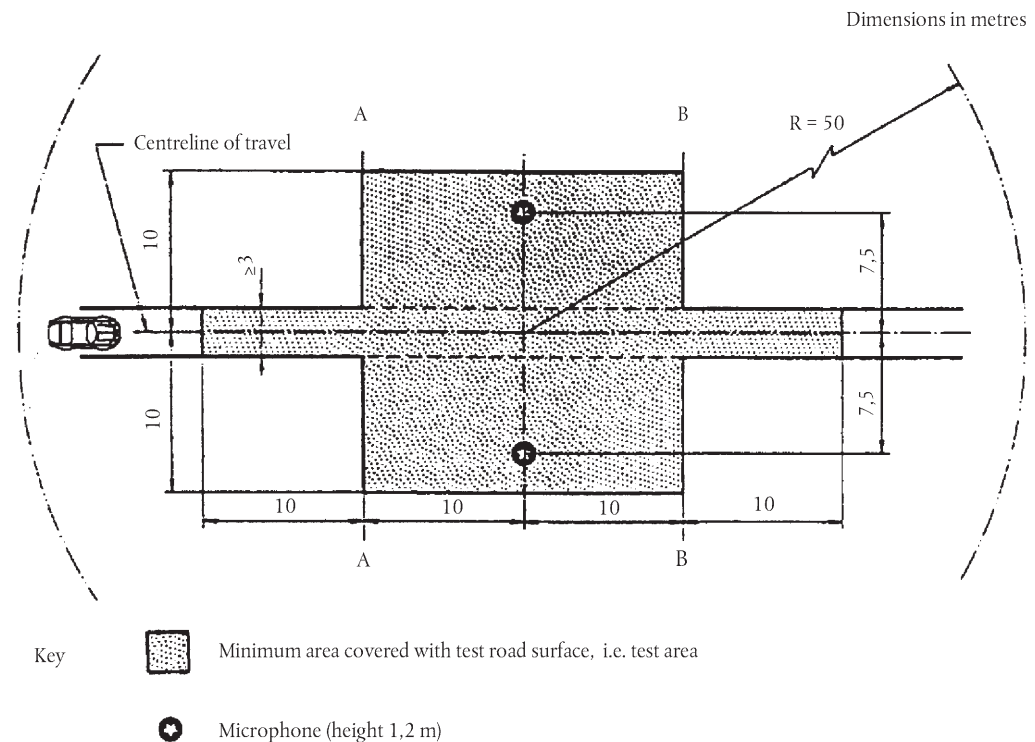

NOTE — There shall be no large acoustically reflective objects within this radius.

Figure 1

#### Minimum requirements for test surface area

The shaded part is called 'Test Area'.

#### 3.2. Design and preparation of the surface

##### 3.2.1. Basic design requirements

The test surface shall meet four design requirements:

3.2.1.1. It shall be a dense asphaltic concrete.

3.2.1.2. The maximum chipping size shall be 8 mm (tolerances allow from 6,3 mm to 10 mm).

3.2.1.3. The thickness of the wearing course shall be  $\geq 30$  mm.

▼ **M1**

3.2.1.4. The binder shall be a straight penetration grade bitumen without modification.

3.2.2. *Design guidelines*

As a guide to the surface constructor, an aggregate grading curve which will give desired characteristics is shown in Figure 2. In addition, Table 1 gives some guidelines in order to obtain the desired texture and durability. The grading curve fits the following formula:

$$P (\% \text{ passing}) = 100.(d/d_{\max})^{1/2}$$

where:

d = square mesh sieve size, in mm

d<sub>max</sub> = 8 mm for the mean curve

10 mm for the lower tolerance curve

6,3 mm for the upper tolerance curve

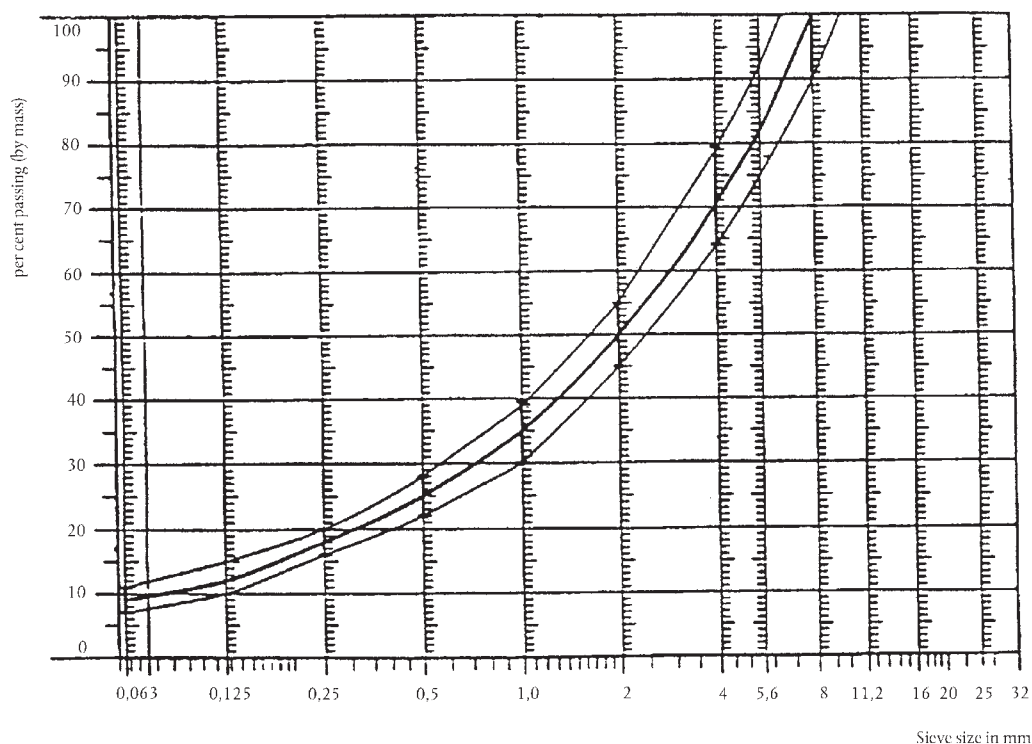

Figure 2:

**Grading curve of the aggregate in the asphaltic mix with tolerances**

In addition to the above, the following recommendations are made:

- (a) The sand fraction (0,063 mm < square mesh sieve size < 2 mm) shall include no more than 55 % natural sand and at least 45 % crushed sand.
- (b) The base and sub-base shall ensure a good stability and evenness, according to best road construction practice.
- (c) The chippings shall be crushed (100 % crushed faces) and of a material with a high resistance to crushing.
- (d) The chippings used in the mix shall be washed.
- (e) No extra chippings shall be added onto the surface.
- (f) The binder hardness expressed as PEN value shall be 40-60, 60-80 or even 80-100 depending on the climatic conditions of the country. The rule is that as hard a binder as possible shall be used, provided this is consistent with common practice.
- (g) The temperature of the mix before rolling shall be chosen so as to achieve by subsequent rolling the required voids content. In order to increase the probability of satisfying the specifications of sections 2.1. to 2.4. above, the compactness shall be studied not only by an appropriate choice of mixing temperature, but also by an appropriate number of passings and by the choice of compacting vehicle.

▼ **M1**

Table 1

**Design guidelines**

	Target values		Tolerances
	By total mass of mix	By mass of the aggregate	
Mass of stones, square mesh sieve (SM) > 2 mm	47,6 %	50,5 %	± 5
Mass of sand 0,063 < SM < 2 mm	38,0 %	40,2 %	± 5
Mass of filler SM <0,063 mm	8,8%	9,3%	± 2
Mass of binder (bitumen)	5,8 %	N.A.	± 0,5
Max. chipping size	8 mm		6,3 – 10
Binder hardness	(see para. 3.2.2. (f))		
Polished stone value (PSV)	> 50		
Compactness, relative to Marshall compactness	98 %		

**4. Test method****4.1. Measurement of the residual voids content**

For the purpose of this measurement, cores have to be taken from the track in at least four different positions which are equally distributed in the test area between lines AA and BB (see figure 1). In order to avoid non-homogeneity and unevenness in the wheel tracks, cores should not be taken in wheel tracks themselves, but close to them. Two cores (minimum) should be taken close to the wheel tracks and one core (minimum) should be taken approximately midway between the wheel tracks and each microphone location.

If there is a suspicion that the condition of homogeneity is not met (see section 2.4.), cores shall be taken from more locations within the test area.

The residual voids content has to be determined for each core, then the average value from all cores shall be calculated and compared with the requirement of section 2.1. In addition, no single core shall have a voids value which is higher than 10 %.

The test surface constructor is reminded of the problem which may arise when the test area is heated by pipes or electrical wires and cores must be taken from this area. Such installations must be carefully planned with respect to future core drilling locations. It is recommended to leave a few locations of size approximately 200 mm × 300 mm where there are no wires/pipes or where the latter are located deep enough in order not to be damaged by cores taken from the surface layer.

**4.2. Sound absorption coefficient**

The sound absorption coefficient (normal incidence) shall be measured by the impedance tube method using the procedure specified in ISO 10534-1: 'Acoustics — Determination of sound absorption coefficient and impedance by a tube method' <sup>(1)</sup>.

Regarding test specimens, the same requirements shall be followed as regarding the residual voids content (see section 4.1). The sound absorption shall be measured in the range between 400 Hz and 800 Hz and in the range between 800 Hz and 1 600 Hz (at least at the centre frequencies of third octave bands) and the maximum values shall be identified for both of these frequency ranges. Then these values, for all test cores, shall be averaged to constitute the final result.

**4.3. Volumetric macrotexture measurement**

For the purpose of this standard, texture depth measurements shall be made on at least 10 positions evenly spaced along the wheel tracks of the test strip and the average value taken to compare with the specified minimum texture depth. See Standard ISO 10844:1994 for description of the procedure.

<sup>(1)</sup> To be published.



**▼M1****5. Stability in time and maintenance****5.1. Age influence**

In common with any other surfaces, it is expected that the tyre-road noise level measured on the test surface may increase slightly during the first 6 — 12 months after construction.

The surface will achieve its required characteristics not earlier than four weeks after construction. The influence of age on the noise from trucks is generally less than that from cars.

Stability over time is determined mainly by polishing and compaction by vehicles driving on the surface. It shall be periodically checked as stated in section 2.5.

**5.2. Maintenance of the surface**

Loose debris or dust which could significantly reduce the effective texture depth must be removed from the surface. In countries with winter climates, salt is sometimes used for de-icing. Salt may alter the surface temporarily or even permanently in such a way as to increase noise and is therefore not recommended.

**5.3. Repaving the test area**

If it is necessary to repave the test track, it is usually unnecessary to repave more than the test strip (of 3 m width in figure 1) where vehicles are driving, provided the test area outside the strip met the requirement of residual voids content or sound absorption when it was measured.

**6. Documentation of the test surface and of tests performed on it****6.1. Documentation of the test surface**

The following data shall be given in a document describing the test surface:

- 6.1.1. The location of the test track.
- 6.1.2. Type of binder, binder hardness, type of aggregate, maximum theoretical density of the concrete (DR), thickness of the wearing course and grading curve determined from cores from the test track.
- 6.1.3. Method of compaction (e.g. type of roller, roller mass, number of passes).
- 6.1.4. Temperature of the mix, temperature of the ambient air and wind speed during laying of the surface.
- 6.1.5. Date when the surface was laid and contractor.
- 6.1.6. All or at least the latest test result, including:
  - 6.1.6.1. the residual voids content of each core;
  - 6.1.6.2. the locations in the test area from where the cores for voids measurements have been taken;
  - 6.1.6.3. the sound absorption coefficient of each core (if measured). Specify the results both for each core and each frequency range as well as the overall average;
  - 6.1.6.4. the locations in the test area from where the cores for absorption measurement have been taken;
  - 6.1.6.5. texture depth, including the number of tests and standard deviation;
  - 6.1.6.6. the institution responsible for tests according to sections 6.1.6.1. and 6.1.6.2. and the type of equipment used;
  - 6.1.6.7. date of the test(s) and date when the cores were taken from the test track.

**6.2. Documentation of vehicle noise tests conducted on the surface**

In the document describing the vehicle noise test(s) it shall be stated whether all the requirements of this standard were fulfilled or not. Reference shall be made to a document according to section 6.1. describing the results which verify this.