

2007 No. 734

CIVIL AVIATION

The Rules of the Air Regulations 2007

Made - - - - - *7th March 2007*
Coming into force - - - *30th March 2007*



2007 No. 734

CIVIL AVIATION

The Rules of the Air Regulations 2007

Made - - - - - *7th March 2007*

Coming into force - - - - - *30th March 2007*

The Secretary of State for Transport, in exercise of his powers under article 95(1) of the Air Navigation Order 2005(a), makes the following Regulations:

1. These Regulations may be cited as the Rules of the Air Regulations 2007 and shall come into force on 30th March 2007.
2. The Rules of the Air set out in Schedule 1 shall have effect and may be cited as the Rules of the Air 2007.
3. The Regulations specified in Schedule 2 are revoked.

Signed by authority of the Secretary of State for Transport

G. Merron

7th March 2007

Parliamentary Under Secretary of State
Department for Transport

SCHEDULE 1

Regulation 2

CONTENTS

SECTION 1
INTERPRETATION

1. Interpretation

SECTION 2
GENERAL

2. Application of Rules to aircraft
3. Misuse of signals and markings
4. Reporting hazardous conditions

(a) S.I. 2005/1970, amended by S.I. 2007/274; there is another amendment not relevant to these Regulations.

SECTION 3
LOW FLYING RULE

5. Low Flying Prohibitions
6. Exemptions from the low flying prohibitions

SECTION 4
GENERAL FLIGHT RULES

7. Weather reports and forecasts
8. Avoiding aerial collisions
9. Converging
10. Approaching head-on
11. Overtaking
12. Flight in the vicinity of an aerodrome
13. Order of landing
14. Landing and take-off
15. Aerobatic manoeuvres
16. Right-hand traffic rule
17. Notification of arrival and departure
18. Flights in Class A airspace
19. Flights in Class C Airspace
20. Choice of VFR or IFR
21. Speed limitations
22. Use of radio navigation aids
23. Simulated instrument flight
24. Practice instrument approaches

SECTION 5
VISUAL FLIGHT RULES

25. Applicability of the Visual Flight Rules
26. Reported Visibility
27. Flights within controlled airspace
28. Flights outside controlled airspace
29. VFR flight plan and air traffic control clearance in Class B, Class C and Class D airspace
30. Maintaining continuous watch and complying with air traffic control clearance
31. Exceptions to rules 29 and 30

SECTION 6
INSTRUMENT FLIGHT RULES

32. Instrument Flight Rules
33. Minimum Height
34. Quadrantal rule and semi-circular rule
35. Flight plan and air traffic control clearance
36. Compliance with air traffic control clearance and notified procedures
37. Position reports

SECTION 7
AERODROME TRAFFIC RULES

38. Application of aerodrome traffic rules
39. Visual signals
40. Movement of aircraft on aerodromes

41. Access to and movement of persons and vehicles on aerodromes
42. Right of way on the ground
43. Action to be taken in case of danger of collision on the ground
44. Launching, picking up and dropping of tow ropes, etc.
45. Flights within aerodrome traffic zones

SECTION 8

LIGHTS AND OTHER SIGNALS TO BE SHOWN OR MADE BY AIRCRAFT

46. General
47. Display of lights by aircraft
48. Failure of navigation and anti-collision lights
49. Flying machines at night
50. Gliders at night
51. Free balloons at night
52. Captive balloons and kites at night
53. Captive balloons and kites by day
54. Airships at night
55. Airships by day

SECTION 9

AERODROME SIGNALS AND MARKINGS—VISUAL AND AURAL SIGNALS

56. General
57. Signals in the Signals Area
58. Markings for paved runways and taxiways
59. Markings on unpaved manoeuvring areas
60. Signals visible from the ground
61. Lights and pyrotechnic signals for control of aerodrome traffic
62. Marshalling signals (from a marshaller to an aircraft)
63. Marshalling signals (from a pilot of an aircraft to a marshaller)
64. Distress, urgency and safety signals

SECTION 1

INTERPRETATION

Interpretation

1. In these Rules—

- (a) ‘air-taxiing’ means flight by a helicopter, or other type of aircraft capable of vertical take-off and landing, above the surface of an aerodrome at a ground speed of less than 20 knots for the purpose of taxiing in accordance with normal aviation practice;
- (b) ‘air traffic control clearance’ means an authorisation by an air traffic control unit for an aircraft to proceed under conditions specified by that unit;
- (c) ‘anti-collision light’ means—
 - (i) in relation to rotorcraft, a flashing red light;
 - (ii) in relation to any other aircraft, a flashing red or flashing white light,

in either case showing in all directions;

- (d) ‘Class C ATS route’ means a route notified as such;

- (e) ‘ground visibility means the horizontal visibility at ground level;
- (f) ‘flight plan’ means a plan containing such information as may be notified to an air traffic control service unit, being information provided or to be provided to that unit which relates to an intended flight, or part of a flight, of an aircraft in accordance with these Rules;
- (g) ‘IFR flight’ means a flight conducted in accordance with the Instrument Flight Rules in Section 6 of these Rules;
- (h) ‘Order’ means the Air Navigation Order 2005;
- (i) ‘runway’ means an area, whether or not paved, which is provided for the take-off or landing of aircraft;
- (j) ‘simulated instrument flight conditions’ means a flight during which mechanical or optical devices are used in order to reduce the field of vision or the range of visibility from the cockpit of the aircraft;
- (k) ‘special VFR flight’ means a flight—
 - (i) made at any time in a control zone which is Class A airspace or made in any other control zone in either Instrument Meteorological Conditions or at night;
 - (ii) in respect of which the appropriate air traffic control unit has given permission for the flight to be made in accordance with special instructions given by that unit instead of in accordance with the Instrument Flight Rules; and
 - (iii) in the course of which the aircraft complies with any instructions given by that unit and the aircraft remains clear of cloud and with the surface in sight;
- (l) ‘VFR flight’ means a flight conducted in accordance with the Visual Flight Rules in Section 5 of these Rules.

SECTION 2

GENERAL

Application of Rules to aircraft

2. These Rules, insofar as they apply to aircraft, shall apply—
- (a) to all aircraft within the United Kingdom;
 - (b) for the purposes of rule 5, to all aircraft in the neighbourhood of an offshore installation; and
 - (c) to all aircraft registered in the United Kingdom, wherever they may be.

Misuse of signals and markings

3.—(1) A signal or marking which is given a meaning by Section 9 or which is required by Section 9 to be used in specified circumstances or for a specified purpose shall not be used except with that meaning, in those circumstances or for that purpose.

(2) A person in an aircraft or on an aerodrome or at any place at which an aircraft is taking off or landing shall not—

- (a) make any signal which may be confused with a signal specified in Section 9; or
- (b) except with lawful authority, make any signal which he knows or ought reasonably to know to be a signal in use for signalling to or from any of Her Majesty’s naval, military or air force aircraft.

Reporting hazardous conditions

4.—(1) If any aircraft encounters hazardous conditions in the course of a flight, the commander of the aircraft shall send to the appropriate air traffic control unit, by the quickest means available

to him, information containing such particulars of the hazardous conditions as may be pertinent to the safety of other aircraft.

(2) The information shall be sent immediately the aircraft encounters the hazardous conditions or as soon as it is possible to do so afterwards.

SECTION 3

LOW FLYING RULE

Low flying prohibitions

5.—(1) Subject to paragraph (2), an aircraft shall comply with the low flying prohibitions in paragraph (3) unless exempted by rule 6.

(2) If an aircraft is flying in circumstances such that more than one of the low flying prohibitions apply, it shall fly at the greatest height required by any of the applicable prohibitions.

(3) The low flying prohibitions are as follows—

(a) Failure of power unit

An aircraft shall not be flown below such height as would enable it to make an emergency landing without causing danger to persons or property on the surface in the event of a power unit failure.

(b) The 500 feet rule

Except with the written permission of the CAA, an aircraft shall not be flown closer than 500 feet to any person, vessel, vehicle or structure.

(c) The 1,000 feet rule

Except with the written permission of the CAA, an aircraft flying over a congested area of a city town or settlement shall not fly below a height of 1,000 feet above the highest fixed obstacle within a horizontal radius of 600 metres of the aircraft.

(d) The land clear rule

An aircraft flying over a congested area of a city, town or settlement shall not fly below such height as would permit the aircraft to land clear of the congested area in the event of a power unit failure.

(e) Flying over open air assemblies

Except with the written permission of the CAA, an aircraft shall not fly over an organised open-air assembly of more than 1,000 persons below the higher of the following heights—

(i) 1,000 feet; or

(ii) such height as would permit the aircraft to land clear of the assembly in the event of a power unit failure.

(f) Landing and taking off near open air assemblies

An aircraft shall not land or take-off within 1,000 metres of an organised, open-air assembly of more than 1,000 persons except—

(i) at an aerodrome, in accordance with procedures notified by the CAA; or

(ii) at a landing site which is not an aerodrome, in accordance with procedures notified by the CAA and with the written permission of the organiser of the assembly.

Exemptions from the low flying prohibitions

6. The exemptions from the low flying prohibitions are as follows—

(a) Landing and taking off

(i) Any aircraft shall be exempt from the low flying prohibitions in so far as it is flying in accordance with normal aviation practice for the purpose of—

- (aa) taking off from, landing at or practising approaches to landing at; or
- (bb) checking navigational aids or procedures at,
 - a Government or licensed aerodrome.
- (ii) Any aircraft shall be exempt from the 500 feet rule when landing and taking-off in accordance with normal aviation practice or air-taxiing.
- (b) Captive balloons and kites
 - None of the low flying prohibitions shall apply to any captive balloon or kite.
- (c) Special VFR flight and notified routes
 - (i) Subject to paragraph (ii), any aircraft shall be exempt from the 1,000 feet rule if—
 - (aa) it is flying on a special VFR flight; or
 - (bb) it is operating in accordance with the procedures notified for the route being flown.
 - (ii) Unless the written permission of the CAA has been obtained, landings may only be made by an aircraft flying under this exemption at a licensed or Government aerodrome.
- (d) Balloons and helicopters over congested areas
 - (i) A balloon shall be exempt from the 1,000 feet rule if it is landing because it is becalmed.
 - (ii) Any helicopter flying over a congested area shall be exempt from the land clear rule.
- (e) Police air operator's certificate
 - Any aircraft flying in accordance with the terms of a police air operator's certificate shall be exempt from the 500 feet rule, the 1,000 feet rule and the prohibitions on flying over open air assemblies and on landing and taking off near open air assemblies.
- (f) Flying displays etc
 - An aircraft taking part in a flying display, air race or contest shall be exempt from the 500 feet rule if it is within a horizontal distance of 1,000 metres of the gathering of persons assembled to witness the event.
- (g) Glider hill-soaring
 - A glider shall be exempt from the 500 feet rule if it is hill-soaring.
- (h) Picking up and dropping at an aerodrome
 - Any aircraft picking up or dropping tow ropes, banners or similar articles at an aerodrome shall be exempt from the 500 feet rule.
- (i) Manoeuvring helicopters
 - (i) Subject to paragraph (ii), a helicopter shall be exempt from the 500 feet rule if it is conducting manoeuvres, in accordance with normal aviation practice, within the boundaries of a licensed or Government aerodrome or, with the written permission of the CAA, at other sites.
 - (ii) When flying in accordance with this exemption the helicopter must not be operated closer than 60 metres to any persons, vessels, vehicles or structures located outside the aerodrome or site.
- (j) Dropping articles with CAA permission
 - Any aircraft shall be exempt from the 500 feet rule if it is flying in accordance with—
 - (i) article 66(3)(f) of the Order (dropping of articles for the purposes of public health or as a measure against weather conditions etcetera, with the permission of the CAA); or
 - (ii) an aerial application certificate granted by the CAA under article 68(2) of the Order.

SECTION 4
GENERAL FLIGHT RULES

Weather reports and forecasts

7.—(1) Subject to paragraph (2), immediately before an aircraft flies the commander of the aircraft shall examine the current reports and forecasts of the weather conditions on the proposed flight path, in order to determine whether Instrument Meteorological Conditions prevail, or are likely to prevail, during any part of the flight.

(2) Paragraph (1) shall only apply if it is reasonably practicable for the commander to obtain current reports and forecasts of the weather conditions on the proposed flight path.

(3) Subject to paragraph (4), an aircraft which is unable to communicate by radio with an air traffic control unit at the aerodrome of destination shall not begin a flight to the aerodrome if—

- (a) the aerodrome is within a control zone; and
- (b) the weather reports and forecasts which it is reasonably practicable for the commander of the aircraft to obtain indicate that it will arrive at that aerodrome when the ground visibility is less than 10 km or the cloud ceiling is less than 1,500 feet.

(4) Paragraph (3) shall not apply if, before take-off, the commander of the aircraft has obtained permission from the air traffic control unit at the aerodrome destination to enter the aerodrome traffic zone.

Avoiding aerial collisions

8.—(1) Notwithstanding that a flight is being made with air traffic control clearance it shall remain the duty of the commander of an aircraft to take all possible measures to ensure that his aircraft does not collide with any other aircraft.

(2) An aircraft shall not be flown in such proximity to other aircraft as to create a danger of collision.

(3) Subject to sub-paragraph (7), aircraft shall not fly in formation unless the commanders of the aircraft have agreed to do so.

(4) An aircraft which is obliged by this Section to give way to another aircraft shall avoid passing over or under the other aircraft, or crossing ahead of it, unless passing well clear of it.

(5) Subject to sub-paragraph (7), an aircraft which has the right-of-way under this rule shall maintain its course and speed.

(6) For the purposes of this rule a glider and a flying machine which is towing it shall be considered to be a single aircraft under the command of the commander of the flying machine.

(7) Sub-paragraphs (3) and (5) shall not apply to an aircraft flying under and in accordance with the terms of a police air operator's certificate.

Converging

9.—(1) Subject to paragraphs (2) and (3) and to rules 10 and 11, aircraft in the air shall give way to other, converging aircraft as follows—

- (a) flying machines shall give way to airships, gliders and balloons;
- (b) airships shall give way to gliders and balloons;
- (c) gliders shall give way to balloons.

(2) Mechanically driven aircraft shall give way to aircraft which are towing other aircraft or objects.

(3) Subject to paragraphs (1) and (2), when two aircraft are converging in the air at approximately the same altitude, the aircraft which has the other on its right shall give way.

Approaching head-on

10. When two aircraft are approaching head-on, or approximately so, in the air and there is a danger of collision, each shall alter its course to the right.

Overtaking

11.—(1) Subject to paragraph (3), an aircraft which is being overtaken in the air shall have the right-of-way and the overtaking aircraft, whether climbing, descending or in horizontal flight, shall keep out of the way of the other aircraft by altering course to the right.

(2) An aircraft which is overtaking another aircraft shall keep out of the way of the other aircraft until that other aircraft has been passed and is clear, notwithstanding any change in the relative positions of the two aircraft.

(3) A glider overtaking another glider in the United Kingdom may alter its course to the right or to the left.

Flight in the vicinity of an aerodrome

12.—(1) Subject to paragraph (2), a flying machine, glider or airship flying in the vicinity of what the commander of the aircraft knows, or ought reasonably to know, to be an aerodrome shall—

- (a) conform to the pattern of traffic formed by other aircraft intending to land at that aerodrome or keep clear of the airspace in which the pattern is formed; and
- (b) make all turns to the left unless ground signals otherwise indicate.

(2) Paragraph (1) shall not apply if the air traffic control unit at that aerodrome otherwise authorises.

Order of landing

13.—(1) An aircraft landing or on its final approach to land shall have the right-of-way over other aircraft in flight or on the ground or water.

(2) An aircraft shall not overtake or cut in front of another aircraft on its final approach to land.

(3) If an air traffic control unit has communicated to any aircraft an order of priority for landing, the aircraft shall approach to land in that order.

(4) If the commander of an aircraft is aware that another aircraft is making an emergency landing, he shall give way to that aircraft.

(5) If the commander gives way in the circumstances referred to in paragraph (4) at night then, notwithstanding that he may have previously received permission to land, he shall not attempt to land until he has received further permission to do so.

(6) Subject to paragraphs (2), (3) and (4), if two or more flying machines, gliders or airships are approaching any place for the purpose of landing, the aircraft at the lower altitude shall have the right-of-way.

Landing and take-off

14.—(1) A flying machine, glider or airship shall take off and land in the direction indicated by the ground signals or, if no such signals are displayed, into the wind, unless good aviation practice demands otherwise.

(2) Subject to paragraph (5), a flying machine or glider shall not land on a runway at an aerodrome if there are other aircraft on the runway.

(3) If take-offs and landings are not confined to a runway—

- (a) when landing a flying machine or glider shall leave clear on its left any aircraft which has landed, is already landing or is about to take off;

- (b) a flying machine or glider which is about to turn shall turn to the left after the commander of the aircraft has satisfied himself that such action will not interfere with other traffic movements; and
- (c) a flying machine which is about to take off shall take up position and manoeuvre in such a way as to leave clear on its left any aircraft which has already taken off or is about to take off.

(4) Subject to paragraph (5) a flying machine shall move clear of the landing area as soon as it is possible to do so after landing.

(5) Paragraphs (2) and (4) shall not apply if the air traffic control unit at the aerodrome otherwise authorises the flying machine or glider.

Aerobatic manoeuvres

15. An aircraft shall not carry out any aerobatic manoeuvre—

- (a) over the congested area of any city, town or settlement; or
- (b) within controlled airspace except with the consent of the appropriate air traffic control unit.

Right-hand traffic rule

16.—(1) Subject to paragraph (2), an aircraft which is flying within the United Kingdom with the surface in sight and following a road, railway, canal or coastline, or any other line of landmarks, shall keep them on its left.

(2) Paragraph (1) shall not apply to an aircraft flying within controlled airspace in accordance with instructions given by the appropriate air traffic control unit.

Notification of arrival and departure

17.—(1) If the commander of an aircraft has caused notice of the intended arrival of the aircraft at an aerodrome to be given to the air traffic control unit or other authority at that aerodrome, he shall ensure that the unit or authority is informed as quickly as possible of—

- (a) any change of intended destination; and
- (b) any estimated delay in arrival of 45 minutes or more.

(2) The commander of an aircraft arriving at or departing from an aerodrome in the United Kingdom shall take all reasonable steps to ensure, upon landing or prior to departure, as the case may be, that the person in charge of the aerodrome or the air traffic control unit or flight information service unit at the aerodrome is given notice of the landing or departure.

(3) Before an aircraft of which the maximum total weight authorised exceeds 5,700 kg takes off from an aerodrome in the United Kingdom on a flight with an intended destination more than 40 km from the aerodrome, the commander shall cause a flight plan, containing such particulars of the intended flight as may be necessary for search and rescue purposes, to be communicated to the air traffic control unit notified for the purpose of this rule.

(4) The commander of an aircraft who intends to fly or who flies across any boundary of airspace notified as either the London or Scottish Flight Information Region (apart from the boundary common to each), shall cause a flight plan, containing such particulars of the intended flight as may be necessary for search and rescue purposes, to be communicated to the appropriate air traffic control unit within the London or Scottish Flight Information Region before flying across the boundary.

Flight in Class A airspace

18.—(1) Subject to paragraphs (2) and (3), the commander of an aircraft flying in Visual Meteorological Conditions in Class A airspace shall comply with rules 35, 36 and 37 as if the flight were an IFR flight.

(2) For the purposes of paragraph (1) rule 36(2) shall not apply.

(3) Paragraph (1) shall not apply to the commander of a glider which is flying in Class A airspace which is notified for the purpose of this paragraph if the glider is flown in accordance with such conditions as may also be notified for that purpose.

Flight in Class C Airspace

19.—(1) Subject to paragraphs (2) and (3) the commander of an aircraft flying in Visual Meteorological Conditions in Class C airspace above flight level 195, or along a Class C ATS route at any level, shall comply with rules 35, 36 and 37 as if the flight were an IFR flight.

(2) For the purposes of paragraph (1) rule 36(2) shall not apply.

(3) Paragraph (1) shall not apply to the commander of an aircraft which is flying in accordance with an authorisation issued by the CAA.

Choice of VFR or IFR

20.—(1) Subject to paragraph (2) an aircraft shall always be flown in accordance with the Visual Flight Rules or the Instrument Flight Rules.

(2) In the United Kingdom an aircraft flying at night shall—

- (a) be flown in accordance with the Instrument Flight Rules outside a control zone;
- (b) be flown in accordance with the Instrument Flight Rules in a control zone unless it is flying on a special VFR flight.

Speed limitations

21.—(1) Subject to paragraph (2), an aircraft shall not fly below flight level 100 at a speed which, according to its air speed indicator, is more than 250 knots.

(2) Paragraph (1) shall not apply to—

- (a) flights in Class A airspace;
- (b) VFR flights or IFR flights in Class B airspace;
- (c) IFR flights in Class C airspace;
- (d) VFR flights in Class C airspace or VFR flights or IFR flights in Class D airspace when authorised by the appropriate air traffic control unit;
- (e) an aircraft taking part in an exhibition of flying for which a permission is required by article 80(1) of the Order, if the flight is made in accordance with the terms of the permission granted to the organiser of the exhibition of flying and in accordance with the conditions of the display authorisation granted to the pilot under article 80(6)(a) of the Order;
- (f) the flight of an aircraft flying in accordance with the A Conditions or the B Conditions; or
- (g) an aircraft flying in accordance with a written permission granted by the CAA authorising the aircraft to exceed the speed limit in paragraph (1).

(3) The CAA may grant a permission for the purpose of paragraph (2)(g) subject to such conditions as it thinks fit and either generally or in respect of any aircraft or class of aircraft.

Use of radio navigation aids

22.—(1) Subject to paragraph (2), the commander of an aircraft shall not make use of any radio navigation aid without complying with such restrictions and procedures as may be notified in relation to that aid.

(2) The commander of an aircraft shall not be required to comply with this rule if—

- (a) he is required to comply with rules 35 and 36; or

- (b) he is otherwise authorised by an air traffic control unit.

Simulated instrument flight

23.—(1) An aircraft shall not be flown in simulated instrument flight conditions unless the conditions in paragraph (2) are met.

- (2) The conditions referred to in paragraph (1) are as follows—
 - (a) the aircraft is fitted with dual controls which are functioning properly;
 - (b) an additional pilot (in this rule called a ‘safety pilot’) is carried in a second control seat of the aircraft for the purpose of providing assistance to the pilot flying the aircraft; and
 - (c) if the safety pilot’s field of vision is not adequate, both forwards and to each side of the aircraft, a third person, who is a competent observer, occupies a position in the aircraft from which his field of vision makes good the deficiencies in that of the safety pilot, and from which he can readily communicate with the safety pilot.

Practice instrument approaches

24.—(1) An aircraft shall not carry out an instrument approach practice within the United Kingdom if it is flying in Visual Meteorological Conditions unless the conditions in paragraph (2) are met.

- (2) The conditions referred to in paragraph (1) are as follows—
 - (a) the appropriate air traffic control unit has previously been informed that the flight is to be made for the purpose of instrument approach practice; and
 - (b) if the flight is not being carried out in simulated instrument flight conditions, a competent observer is carried in such a position in the aircraft that he has an adequate field of vision and can readily communicate with the pilot flying the aircraft.

SECTION 5

VISUAL FLIGHT RULES

Applicability of the Visual Flight Rules

- 25.**—(1) Within controlled airspace rules 27, 29 and 30 shall be the Visual Flight Rules.
- (2) Outside controlled airspace rule 28 shall be the Visual Flight Rules.

Reported visibility

26. For the purposes of an aircraft taking off from or approaching to land at an aerodrome within Class B, Class C, or Class D airspace, the visibility, if any, communicated to the commander of the aircraft by the appropriate air traffic control unit shall be taken to be the flight visibility for the time being.

Flight within controlled airspace

- 27.**—(1) Subject to paragraph (4), an aircraft flying within Class B airspace—
 - (a) at or above flight level 100 shall remain clear of cloud and in a flight visibility of at least 8 km; and
 - (b) below flight level 100 shall remain clear of cloud and in a flight visibility of at least 5 km.
- (2) Subject to paragraphs (3) and (4), an aircraft flying within Class C, Class D or Class E airspace—
 - (a) at or above flight level 100 shall remain at least 1,500 metres horizontally and 1,000 feet vertically away from cloud and in a flight visibility of at least 8 km;

- (b) below flight level 100 shall remain at least 1,500 metres horizontally and 1,000 feet vertically away from cloud and in a flight visibility of at least 5 km.
- (3) An aircraft shall be deemed to have complied with paragraph (2)(b) if—
 - (a) the aircraft is not a helicopter and it—
 - (i) flies at or below 3,000 feet above mean sea level;
 - (ii) flies at a speed which, according to its airspeed indicator, is 140 knots or less; and
 - (iii) remains clear of cloud, with the surface in sight and in a flight visibility of at least 5 km; or
 - (b) the aircraft is a helicopter and it—
 - (i) flies at or below 3,000 feet above mean sea level; and
 - (ii) remains clear of cloud, with the surface in sight and in a flight visibility of at least 1,500 metres.
- (4) Paragraphs (1) and (2) shall not apply to a helicopter that is air-taxiing or conducting manoeuvres in accordance with rule 6(i).

Flight outside controlled airspace

28.—(1) Subject to paragraph (6), an aircraft flying outside controlled airspace at or above flight level 100 shall remain at least 1,500 metres horizontally and 1,000 feet vertically away from cloud and in a flight visibility of at least 8 km.

(2) Subject to paragraphs (3), (4), (5) and (6), an aircraft flying outside controlled airspace below flight level 100 shall remain at least 1,500 metres horizontally and 1,000 feet vertically away from cloud and in a flight visibility of at least 5 km.

(3) Paragraph (2) shall not apply to an aircraft which—

- (a) flies at or below 3,000 feet above mean sea level;
- (b) remains clear of cloud with the surface in sight; and
- (c) is in a flight visibility of at least 5 km.

(4) Paragraph (2) shall not apply to an aircraft which is not a helicopter and which—

- (a) flies at or below 3,000 feet above mean sea level;
- (b) flies at a speed which, according to its air speed indicator, is 140 knots or less;
- (c) remains clear of cloud with the surface in sight; and
- (d) is in a flight visibility of at least 1,500 metres.

(5) Paragraph (2) shall not apply to a helicopter which—

- (a) flies at or below 3,000 feet above mean sea level;
- (b) flies at a speed which, having regard to the visibility, is reasonable; and
- (c) remains clear of cloud with the surface in sight.

(6) Paragraphs (1) and (2) shall not apply to a helicopter which is air-taxiing or conducting manoeuvres in accordance with rule 6(i).

VFR flight plan and air traffic control clearance in Class B, Class C or Class D airspace

29.—(1) Subject to rule 31, before an aircraft flies within Class B, Class C or Class D airspace during the notified hours of watch of the appropriate air traffic control unit, the commander of the aircraft shall—

- (a) cause to be communicated to the appropriate air traffic control unit a flight plan which complies with paragraphs (2) and (3) (as appropriate); and
- (b) obtain an air traffic control clearance to fly within that airspace.

(2) The flight plan shall contain such particulars of the flight as may be necessary to enable the air traffic control unit to issue an air traffic control clearance and for search and rescue purposes.

(3) The flight plan required for a flight within United Kingdom reduced vertical separation minimum airspace shall also state whether or not the aircraft is equipped with height keeping systems, as required by articles 57 or 58 of the Order.

(4) The commander of an aircraft shall not cause a flight plan to be communicated to the appropriate air traffic control unit for VFR flight in Class C airspace above FL195 or along a Class C ATS route at any level unless authorised to do so by the CAA.

Maintaining continuous watch and complying with air traffic control instructions

30.—(1) Subject to rule 31, whilst flying within Class B, Class C or Class D airspace during the notified hours of watch of the appropriate air traffic control unit, the commander of an aircraft shall—

- (a) cause a continuous watch to be maintained on the notified radio frequency appropriate to the circumstances; and
- (b) comply with any instructions which the appropriate air traffic control unit may give.

Exceptions to rules 29 and 30

31.—(1) Rule 29 shall not apply if the aircraft has otherwise been authorised by the appropriate air traffic control unit.

(2) Rules 29(1) and 30 shall not apply to any glider flying or intending to fly in Class B airspace notified for the purpose of this paragraph.

(3) Rules 29(1) and 30 shall not apply to any glider which—

- (a) flies during the day;
- (b) is in controlled airspace notified for the purpose of this paragraph; and
- (c) remains at least 1,500 metres horizontally and 1,000 feet vertically away from cloud and in a flight visibility of at least 8 km.

(4) Rules 29(1) and 30 shall not apply to any mechanically driven aircraft without radio equipment if—

- (a) it flies during the day;
- (b) it is in controlled airspace notified for the purpose of this paragraph;
- (c) it remains at least 1,500 metres horizontally and 1,000 feet vertically away from cloud and in a flight visibility of at least 5 km; and
- (d) its commander has previously obtained the permission of the appropriate air traffic control unit to fly within the controlled airspace.

SECTION 6

INSTRUMENT FLIGHT RULES

Instrument Flight Rules

32.—(1) For flights within controlled airspace rules 33, 34, 35, 36 and 37 shall be the Instrument Flight Rules.

(2) For flights outside controlled airspace rules 33 and 34 shall be the Instrument Flight Rules.

Minimum height

33.—(1) Subject to paragraphs (2) and (3), an aircraft shall not fly at a height of less than 1,000 feet above the highest obstacle within a distance of 5 nautical miles of the aircraft unless—

- (a) it is necessary for the aircraft to do so in order to take off or land;
 - (b) the aircraft flies on a route notified for the purposes of this rule;
 - (c) the aircraft has been otherwise authorised by the competent authority in relation to the area over which the aircraft is flying; or
 - (d) the aircraft flies at an altitude not exceeding 3,000 feet above mean sea level and remains clear of cloud and with the surface in sight and in a flight visibility of at least 800 metres.
- (2) The aircraft shall comply with rule 5.
- (3) Paragraph (1) shall not apply to a helicopter that is air-taxiing or conducting manoeuvres in accordance with rule 6(i).

Quadrantal rule and semi-circular rule

34.—(1) Subject to paragraphs (2) and (3), an aircraft in level flight above 3,000 feet above mean sea level or above the appropriate transition altitude, whichever is the higher, shall be flown at a level appropriate to its magnetic track, in accordance with Table 1 or Table 2, as appropriate.

- (2) For the purposes of paragraph (1), the level of flight shall be measured by an altimeter set—
- (a) in the case of a flight over the United Kingdom, to a pressure setting of 1013.2 hectopascals; or
 - (b) in the case of any other flight, according to the system published by the competent authority in relation to the area over which the aircraft is flying.
- (3) An aircraft may be flown at a level other than the level required by paragraph (1) if it flies:
- (a) in conformity with instructions given by an air traffic control unit;
 - (b) in accordance with notified en-route holding patterns; or
 - (c) in accordance with holding procedures notified in relation to an aerodrome.

(4) For the purposes of this rule ‘transition altitude’ means the altitude which is notified in relation to flights over notified areas.

Table 1—Flights At Levels Below 19,500 Feet

<i>Magnetic Track</i>	<i>Cruising Level</i>
Less than 90°	Odd thousands of feet
90° but less than 180°	Odd thousands of feet + 500 feet
180° but less than 270°	Even thousands of feet
270° but less than 360°	Even thousands of feet + 500 feet

Table 2—Flights At Levels Above 19,500 Feet

<i>Magnetic Track</i>	<i>Cruising Level</i>
Less than 180°	21,000 feet
	23,000 feet
	25,000 feet
	27,000 feet
	29,000 feet
	31,000 feet
	33,000 feet
	35,000 feet
	37,000 feet
	39,000 feet
	41,000 feet or higher levels at intervals of 4,000 feet
	180° but less than 360°
22,000 feet	
24,000 feet	
26,000 feet	
28,000 feet	
30,000 feet	
32,000 feet	
34,000 feet	
36,000 feet	
38,000 feet	
40,000 feet	
43,000 feet or higher levels at intervals of 4,000 feet	

Flight plan and air traffic control clearance

35.—(1) Before an aircraft either takes off from a point within any controlled airspace or otherwise flies within any controlled airspace the commander of the aircraft shall—

- (a) send or transmit a flight plan complying with paragraph (2) to the appropriate air traffic control unit; and
- (b) obtain an air traffic control clearance based on that flight plan.

(2) The flight plan shall—

- (a) contain such particulars of the intended flight as may be necessary to enable the air traffic control unit to issue an air traffic control clearance and for search and rescue purposes; and
- (b) for a flight within United Kingdom reduced vertical separation minimum airspace, also state whether or not the aircraft is equipped with height keeping systems as required by articles 57 and 58 of the Order.

(3) Unless he has requested the appropriate air traffic control unit to cancel his flight plan, the commander of the aircraft shall forthwith inform that unit when the aircraft lands within or leaves the controlled airspace.

Compliance with air traffic control clearance and notified procedures

36.—(1) Subject to paragraph (2), the commander of the aircraft shall fly in conformity with—

- (a) the air traffic control clearance issued for the flight, as amended by any further instructions given by an air traffic control unit; and, unless he is otherwise authorised by the appropriate air traffic control unit,

- (b) the instrument departure procedures notified in relation to the aerodrome of departure; and
 - (c) the holding and instrument approach procedures notified in relation to the aerodrome of destination.
- (2) The commander of the aircraft shall not be required to comply with paragraph (1) if—
- (a) he is able to fly in uninterrupted Visual Meteorological Conditions for so long as he remains in controlled airspace; and
 - (b) he has informed the appropriate air traffic control unit of his intention to continue the flight in compliance with Visual Flight Rules and has requested that unit to cancel his flight plan.
- (3) If any deviation is made from the provisions of paragraph (2) for the purpose of avoiding immediate danger the commander of the aircraft shall inform the appropriate air traffic control unit of the deviation as soon as possible.

Position reports

37. The commander of an aircraft in IFR flight who flies in or is intending to enter controlled airspace shall report to the appropriate air traffic control unit the time, position and level of the aircraft at such reporting points or at such intervals of time as may be notified for this purpose or as may be directed by the air traffic control unit.

SECTION 7

AERODROME TRAFFIC RULES

Application of aerodrome traffic rules

38. The rules in this Section which expressly apply to flying machines shall also be observed, so far as is practicable, by all other aircraft.

Visual signals

39.—(1) Subject to paragraph (2), the commander of a flying machine on, or in the pattern of traffic flying at, an aerodrome shall—

- (a) observe such visual signals as may be displayed at or directed to him from the aerodrome by the authority of the person in charge of the aerodrome; and
- (b) obey any instructions which may be given to him by means of such signals.

(2) The commander of a flying machine shall not be required to obey such signals if it is inadvisable to do so in the interests of safety.

Movement of aircraft on aerodromes

40. An aircraft shall not taxi on the apron or the manoeuvring area of an aerodrome without the permission of either—

- (a) the person in charge of the aerodrome; or
- (b) the air traffic control unit or aerodrome flight information service unit notified as being on watch at the aerodrome.

Access to and movement of persons and vehicles on aerodromes

41.—(1) Unless there is a public right of way over it, a person or vehicle shall—

- (a) not go onto any part of an aerodrome without the permission of the person in charge of that part of the aerodrome; and
- (b) comply with any conditions subject to which that permission may be granted.

(2) A person or vehicle shall—

(a) not go onto or move on the manoeuvring area of an aerodrome which has an air traffic control unit or an aerodrome flight information service unit without the permission of that unit; and

(b) comply with any conditions subject to which that permission may be granted.

(3) Any permission granted for the purposes of this rule may be granted in respect of persons or vehicles generally, or in respect of any particular person or vehicle or any class of person or vehicle.

Right of way on the ground

42.—(1) This rule shall apply to flying machines and vehicles on any part of a land aerodrome provided for the use of aircraft and under the control of the person in charge of the aerodrome.

(2) Notwithstanding any air traffic control clearance it shall remain the duty of the commander of a flying machine to take all possible measures to ensure that his flying machine does not collide with any other aircraft or vehicle.

(3) Flying machines and vehicles shall give way to aircraft which are taking off or landing.

(4) Vehicles and flying machines which are not taking off or landing shall give way to vehicles towing aircraft.

(5) Vehicles which are not towing aircraft shall give way to aircraft.

Action to be taken in case of danger of collision on the ground

43.—(1) Subject to rules 42 and 14(3), this rule shall apply if there is any danger of collision between two flying machines on the ground.

(2) If the two flying machines are approaching head-on, or approximately so, each shall alter its course to the right.

(3) If the two flying machines are on converging courses, the flying machine which has the other flying machine on its right shall give way to that other flying machine and shall avoid crossing ahead of it unless passing well clear of it.

(4) A flying machine which is being overtaken by another flying machine shall have the right-of-way over the flying machine overtaking it.

(5) A flying machine which is overtaking another flying machine shall keep out of the way of the other flying machine by altering its course to the left until that other flying machine has been passed and is clear, notwithstanding any change in the relative positions of the two flying machines.

(6) A vehicle shall—

(a) overtake another vehicle on the right hand side of that vehicle ; and

(b) keep to the left when passing another vehicle which is approaching head-on or approximately so.

Launching, picking up and dropping of tow ropes, etc.

44.—(1) Tow ropes, banners or similar articles towed by aircraft shall not be launched at an aerodrome except in accordance with arrangements made with:

(a) the air traffic control unit at the aerodrome; or

(b) if there is no such unit, the person in charge of the aerodrome.

(2) Tow ropes, banners or similar articles towed by aircraft shall not be picked up by or dropped from aircraft at an aerodrome except:

(a) in accordance with arrangements made with the air traffic control unit at the aerodrome or, if there is no such unit, with the person in charge of the aerodrome; or

- (b) in the area designated by the marking described in rule 59(9), but only when the aircraft is flying in the direction appropriate for landing.

Flights within aerodrome traffic zones

45.—(1) Paragraphs (2) and (3) shall apply only in relation to those aerodromes described in Column 1 of Table 3 as are notified for the purposes of this rule and at such times as are specified in Column 2 of the Table.

Table 3

<i>Column 1</i>	<i>Column 2</i>
(a) A Government aerodrome	At such times as are notified
(b) An aerodrome having an air traffic control unit or flight information service unit	During the notified hours of watch of the air traffic control unit or the flight information service unit
(c) A licensed aerodrome having a means of two-way radio communication with aircraft	During the notified hours of watch of the air/ground station

(2) An aircraft shall not fly, take off or land within the aerodrome traffic zone of an aerodrome unless the commander of the aircraft has complied with paragraphs (3), (4) or (5), as appropriate.

(3) If the aerodrome has an air traffic control unit the commander shall obtain the permission of the air traffic control unit to enable the flight to be conducted safely within the zone.

(4) If the aerodrome has a flight information service unit the commander shall obtain information from the flight information service unit to enable the flight to be conducted safely within the zone.

(5) If there is no flight information service unit at the aerodrome the commander shall obtain information from the air/ground communication service to enable the flight to be conducted safely within the zone.

(6) The commander of an aircraft flying within the aerodrome traffic zone of an aerodrome shall—

- (a) cause a continuous watch to be maintained on the appropriate radio frequency notified for communications at the aerodrome; or
- (b) if this is not possible, cause a watch to be kept for such instructions as may be issued by visual means; and
- (c) if the aircraft is fitted with means of communication by radio with the ground, communicate his position and height to the air traffic control unit, the flight information service unit or the air/ground communication service at the aerodrome (as the case may be) on entering the zone and immediately prior to leaving it.

SECTION 8

LIGHTS AND OTHER SIGNALS TO BE SHOWN OR MADE BY AIRCRAFT

General

46.—(1) For the purposes of this Section the horizontal plane of a light shown by an aircraft means the plane which would be the horizontal plane passing through the source of that light if the aircraft were in level flight.

(2) If it is necessary to fit more than one lamp in order to show a light required by this Section because of the physical construction of an aircraft, the lamps shall be so fitted and constructed that, so far as is reasonably practicable, not more than one such lamp is visible from any one point outside the aircraft.

(3) If a light is required by this Section to show through specified angles in the horizontal plane, the lamps giving such light shall be so constructed and fitted that the light is visible—

- (a) from any point in any vertical plane within those angles throughout angles of 90° above and below the horizontal plane; but
- (b) so far as is reasonably practicable, through no greater angle, either in the horizontal plane or the vertical plane.

(4) If a light is required by this Section to show in all directions, the lamps giving such light shall be so constructed and fitted that, so far as is reasonably practicable, the light is visible from any point in the horizontal plane and on any vertical plane passing through the source of that light.

(5) Notwithstanding the provisions of this Section the commander of an aircraft may switch off or reduce the intensity of any flashing light fitted to the aircraft if such a light does or is likely to—

- (a) adversely affect the performance of the duties of any member of the flight crew; or
- (b) subject an outside observer to unreasonable dazzle.

Display of lights by aircraft

47.—(1) During the night an aircraft shall—

- (a) display such of the lights specified in this Section as it is required by this Section; and
- (b) subject to rule 49(6), not display any other lights which might obscure or otherwise impair the visibility of, or be mistaken for, such lights.

(2) Subject to rule 48(4) an aircraft fitted with an anti-collision light shall display that light in flight during the day.

(3) A flying machine on a United Kingdom aerodrome shall—

- (a) during the night display either the lights which it would be required to display when flying or the lights specified in rule 49(5)(c) unless it is stationary on the apron or on that part of the aerodrome provided for the maintenance of aircraft; and
- (b) during the day and night and subject to paragraph (4), display a red anti-collision light, if it is fitted with one, when it is stationary on the apron with engines running.

(4) A helicopter to which article 38 applies may, when stationary on an offshore installation, switch off the anti-collision light required to be shown by paragraph (3)(b) as long as that is done in accordance with a procedure contained in the operations manual of the helicopter as a signal to ground personnel that it is safe to approach the helicopter for the purpose of embarkation or disembarkation of passengers or the loading or unloading of cargo.

Failure of navigation and anti-collision lights

48.—(1) Paragraphs (2), (3) and (4) shall apply to aircraft in the United Kingdom.

(2) An aircraft shall not depart from an aerodrome if there is a failure of any light which these Rules require to be displayed at night and the light cannot be immediately repaired or replaced.

(3) Subject to paragraph (4), if the aircraft is in flight and any such light as is referred to in paragraph (2) fails and cannot be immediately repaired or replaced, the aircraft shall land as soon as it can safely do so, unless authorised by the appropriate air traffic control unit to continue its flight.

(4) An aircraft may continue to fly during the day in the event of a failure of an anti-collision light provided the light is repaired at the earliest practicable opportunity.

Flying machines at night

49.—(1) Subject to paragraph (6), a flying machine flying at night shall display lights in accordance with paragraphs (2), (3) or (4).

(2) In the case of—

- (a) a flying machine registered in the United Kingdom which has a maximum total weight authorised of more than 5,700 kg; or
- (b) any other flying machine registered in the United Kingdom which conforms to a type first issued with a type certificate on or after 1st April 1988,

the flying machine shall display the system of lights specified in paragraph 5(b).

(3) A flying machine registered in the United Kingdom which—

- (a) conforms to a type first issued with a type certificate before 1st April 1988; and
- (b) has a maximum total weight authorised of 5,700 kg or less,

shall display the system of lights specified in—

- (i) paragraph (5)(a); or
- (ii) paragraph (5)(b); or
- (iii) paragraph (5)(d), but excluding sub-paragraph (ii) of that paragraph.

(4) In the case of any other flying machine, one of the systems of lights specified in paragraph (5) shall be displayed.

(5) The systems of lights referred to in paragraphs (2), (3) and (4) are as follows—

- (a) A steady green light of at least five candela showing to the starboard side through an angle of 110° from dead ahead in the horizontal plane, a steady red light of at least five candela showing to the port side through an angle of 110° from dead ahead in the horizontal plane; and a steady white light of at least three candela showing through angles of 70° from dead astern to each side in the horizontal plane;
- (b) the lights specified in sub-paragraph (a) and an anti-collision light;
- (c) the lights specified in sub-paragraph (a), but all being flashing lights (rather than steady lights) flashing together;
- (d) the lights specified in sub-paragraph (a), but all being flashing lights (rather than steady lights) flashing together in alternation with one or both of the following—
 - (i) a flashing white light of at least twenty candela showing in all directions;
 - (ii) a flashing red light of at least twenty candela showing through angles of 70° from dead astern to each side in the horizontal plane.

(6) If the lamp showing either the red or the green light specified in paragraph (5)(a) is fitted more than 2 metres from the wing tip, another lamp may be fitted at the wing tip to indicate its position showing a steady light of the same colour through the same angle.

Gliders at night

50. A glider flying at night shall display either a steady red light of at least five candela, showing in all directions, or lights in accordance with rule 49(5) and (6).

Free balloons at night

51. A free balloon flying at night shall display a steady red light of at least five candela showing in all directions, suspended not less than 5 metres and not more than 10 metres below the basket, or if there is no basket, below the lowest part of the balloon.

Captive balloons and kites at night

52.—(1) A captive balloon or kite flying at night at a height exceeding 60 metres above the surface shall display lights in accordance with paragraphs (2), (3) and (4).

(2) A group of two steady lights shall be displayed consisting of a white light placed 4 metres above a red light, both being of at least five candela and showing in all directions, the white light being placed not less than 5 metres nor more than 10 metres below the basket or, if there is no basket, below the lowest part of the balloon or kite.

(3) On the mooring cable of the balloon or kite, at intervals of not more than 300 metres measured from the group of lights specified in paragraph (2), there shall be displayed—

- (a) groups of two lights of the colour and power and in the relative positions specified in paragraph (2); and
- (b) if the lowest group of lights is obscured by cloud, an additional group of such lights below the cloud base.

(4) On the surface of the ground there shall be displayed a group of three flashing lights arranged—

- (a) in a horizontal plane at the apexes of a triangle, approximately equilateral, each side of which measures at least 25 metres;
- (b) so that one side of the triangle shall be approximately at right angles to the horizontal projection of the cable and shall be delimited by two red lights; and
- (c) so that the third light shall be a green light, placed so that the triangle encloses the object on the surface to which the balloon or kite is moored.

Captive balloons and kites by day

53.—(1) A captive balloon flying by day at a height exceeding 60 metres above the surface shall have attached to its mooring cable tubular streamers which are—

- (a) not less than 40 centimetres in diameter and 2 metres in length; and
- (b) marked with alternate bands of red and white 50 centimetres wide at intervals of not more than 200 metres measured from the basket or, if there is no basket, from the lowest part of the balloon.

(2) A kite flying by day at a height exceeding 60 metres above the surface shall have attached to its mooring cable either:

- (a) tubular streamers as specified in paragraph (1); or
- (b) at intervals of not more than 100 metres measured from the lowest part of the kite, streamers not less than 80 centimetres long and 30 centimetres wide at their widest point, marked with alternate bands of red and white 10 centimetres wide.

Airships at night

54.—(1) Except as provided in paragraph (2), an airship flying at night shall display the following lights—

- (a) a steady white light of at least five candela showing through angles of 110° from dead ahead to each side in the horizontal plane;
- (b) a steady green light of at least five candela showing to the starboard side through an angle of 110° from dead ahead in the horizontal plane;
- (c) a steady red light of at least five candela showing to the port side through an angle of 110° from dead ahead in the horizontal plane;
- (d) a steady white light of at least five candela showing through angles of 70° from dead astern to each side in the horizontal plane; and
- (e) an anti-collision light.

(2) Subject to paragraph (5), an airship flying at night in any of the circumstances referred to in paragraph (3) shall display the lights specified in paragraph (4).

(3) The circumstances are as follows—

- (a) if the airship is not under command; or
- (b) has voluntarily stopped its engines, or
- (c) is being towed.

(4) The lights specified are the following lights—

- (a) the white lights specified in paragraph (1)(a) and (d);
 - (b) two steady, red lights, each of at least five candela, showing in all directions, suspended below the control car so that one is at least 4 metres above the other and at least 8 metres below the control car; and
 - (c) if the airship is making way but not otherwise, the green and red lights specified in paragraph (1)(b) and (c).
- (5) An airship picking up its moorings at night shall display the lights specified in paragraph (1).
- (6) An airship moored to a mooring mast within the United Kingdom at night shall display, at or near the rear of the airship, a steady, white light of at least five candela showing in all directions.
- (7) An airship moored otherwise than to a mooring mast within the United Kingdom at night shall display—
- (a) a white light of at least five candela showing through angles of 110° from dead ahead to each side in the horizontal plane; and
 - (b) a white light of at least five candela showing through angles of 70° from dead astern to each side in the horizontal plane.

Airships by day

55.—(1) An airship flying during the day in any of the circumstances referred to in paragraph (2) shall display two black balls suspended below the control car so that one is at least 4 metres above the other and at least 8 metres below the control car.

(2) The circumstances are as follows—

- (a) if the airship is not under command;
- (b) if it has voluntarily stopped its engines; or
- (c) if it is being towed.

(3) For the purposes of this rule and rule 54—

- (a) an airship shall be deemed not to be under command when it is unable to execute a manoeuvre which it may be required to execute by these Rules; and
- (b) an airship shall be deemed to be making way when it is not moored and is in motion.

SECTION 9

AERODROME SIGNALS AND MARKINGS—VISUAL AND AURAL SIGNALS

General

56.—(1) Within the United Kingdom any signal or marking which is specified in this Section and which is given or displayed—

- (a) by any person in an aircraft; or
- (b) at an aerodrome; or
- (c) at any other place which is being used by aircraft for landing or take-off,

shall have the meaning assigned to it in this Section.

(2) Apart from those referred to in rule 60(6) and the distances at which markings must be placed, all dimensions of signals or markings specified in this Section of these Rules shall be subject to a tolerance of 10 per cent, plus or minus.

Signals in the Signals Area

57.—(1) Whenever any signal specified in this rule is displayed it shall be placed in a signals area, which shall be a square visible from all directions bordered by a white strip 30 centimetres wide and with the internal sides measuring 12 metres.

(2) A white landing T, as illustrated in this paragraph,

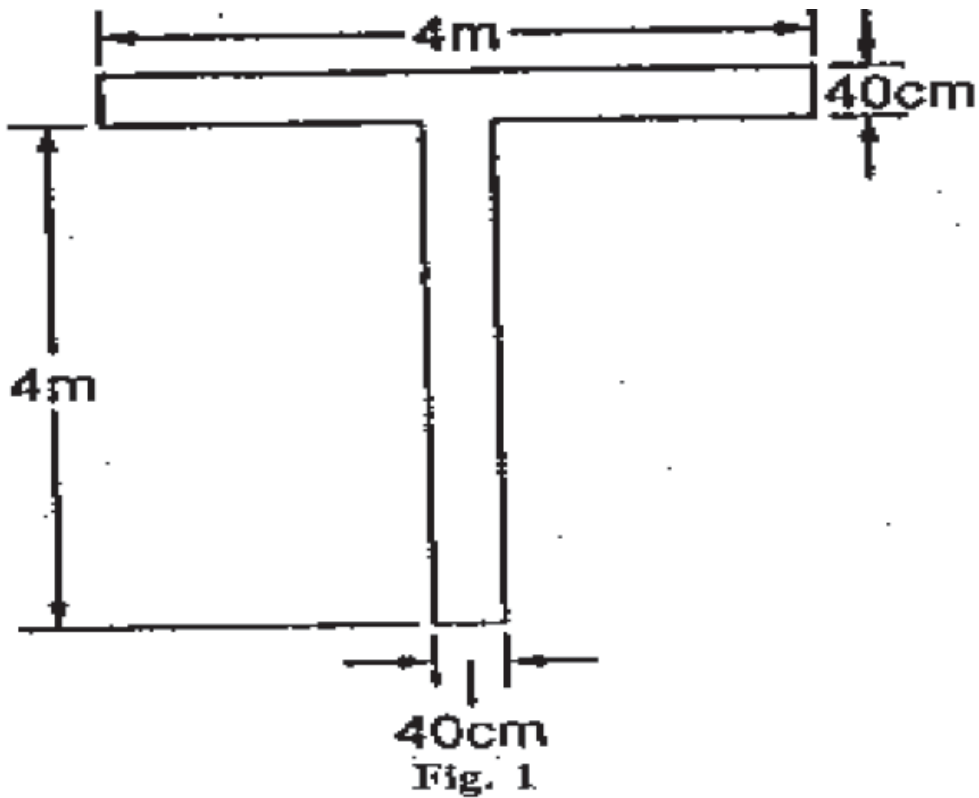

signifies that aeroplanes and gliders taking off or landing shall do so in a direction parallel with the shaft of the T and towards the cross arm, unless otherwise authorised by the appropriate air traffic control unit.

(3) A white disc 60 centimetres in diameter displayed alongside the cross arm of the T and in line with the shaft of the T, as illustrated in this paragraph,

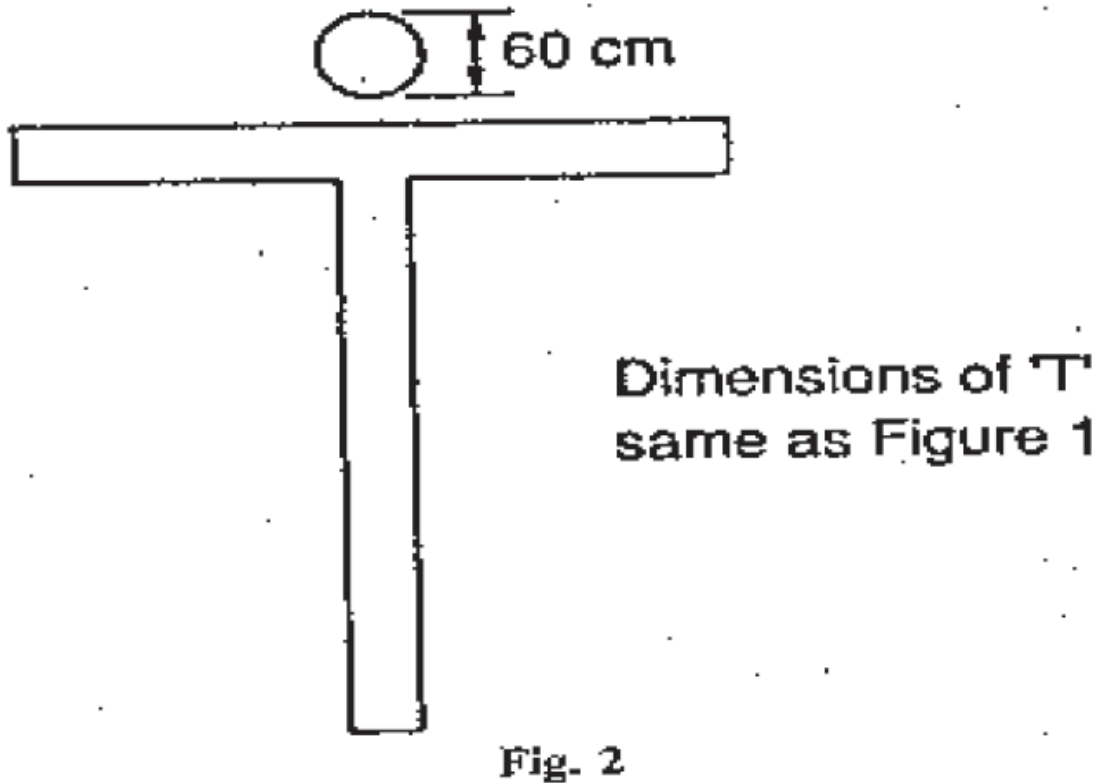

signifies that the direction of landing and take off do not necessarily coincide.

(4) A white dumb-bell, as illustrated in this paragraph,

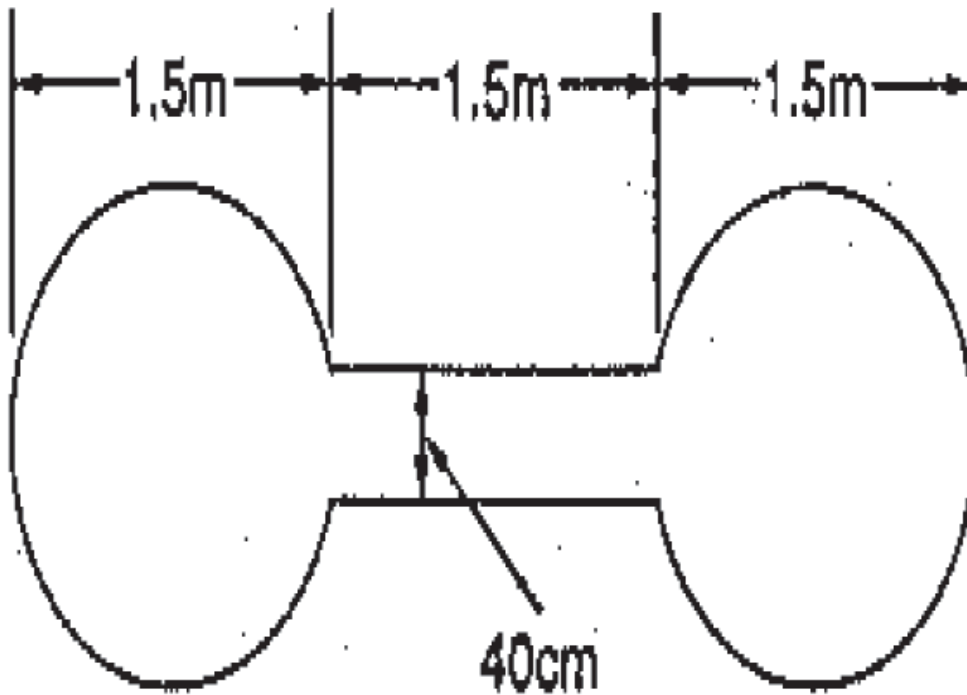

Fig. 3

signifies that movements of aeroplanes and gliders on the ground shall be confined to paved, metallised or similar hard surfaces.

A white dumb-bell, as described in paragraph (4), but with a black strip 60 centimetres wide across each disc at right angles to the shaft of the dumb-bell, as illustrated in this paragraph,

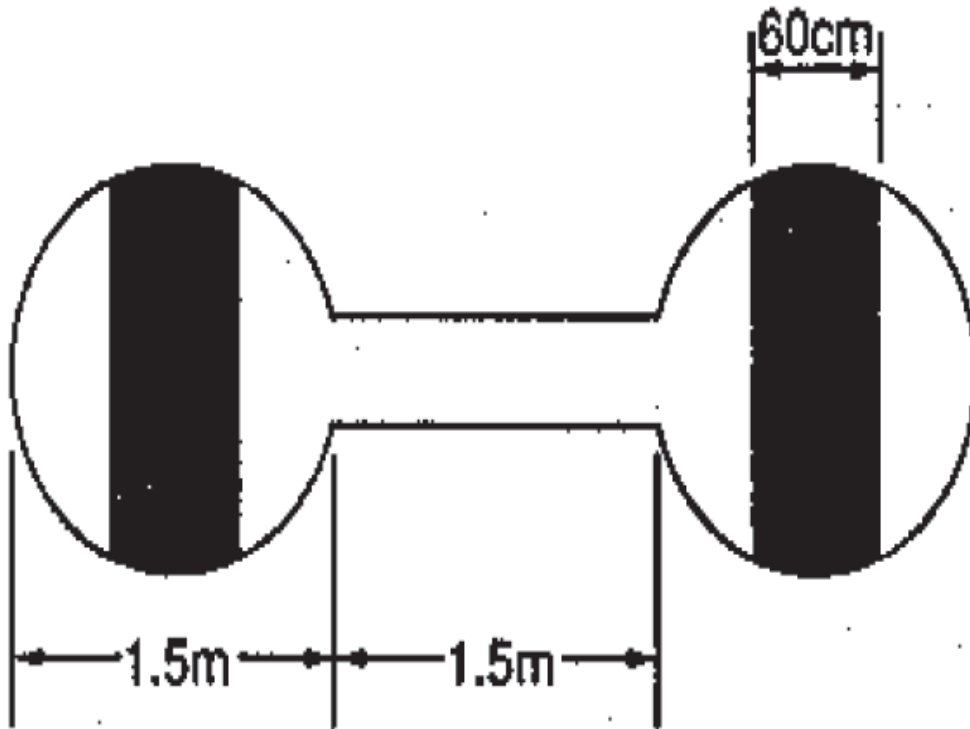

Fig. 4

signifies that aeroplanes and gliders taking off or landing shall do so on a runway but that movement on the ground is not confined to paved, metalled or similar hard surfaces.

(5) A red and yellow striped arrow, as illustrated in this paragraph,

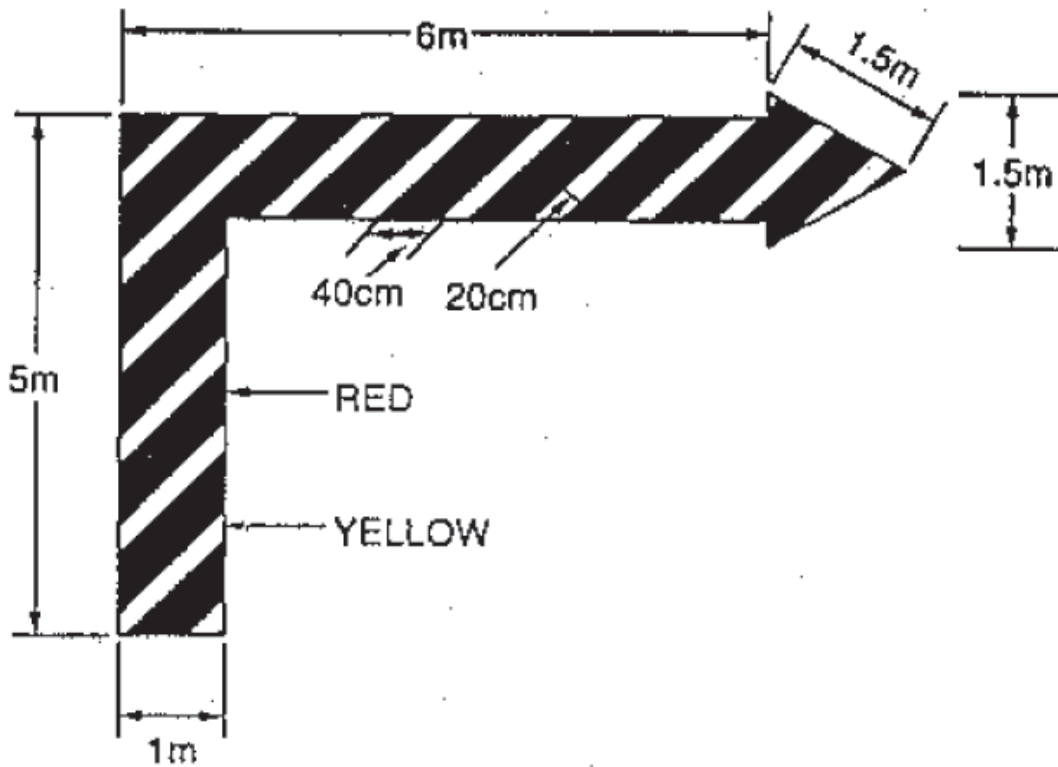

Fig. 5

the shaft of which is one metre wide and which is placed along the whole or a total of 11 metres of two adjacent sides of the signals area, and pointing in a clockwise direction, signifies that a right-hand circuit is in force.

(6) A red panel 3 metres square with a yellow strip along one diagonal 50 centimetres wide, as illustrated in this paragraph,

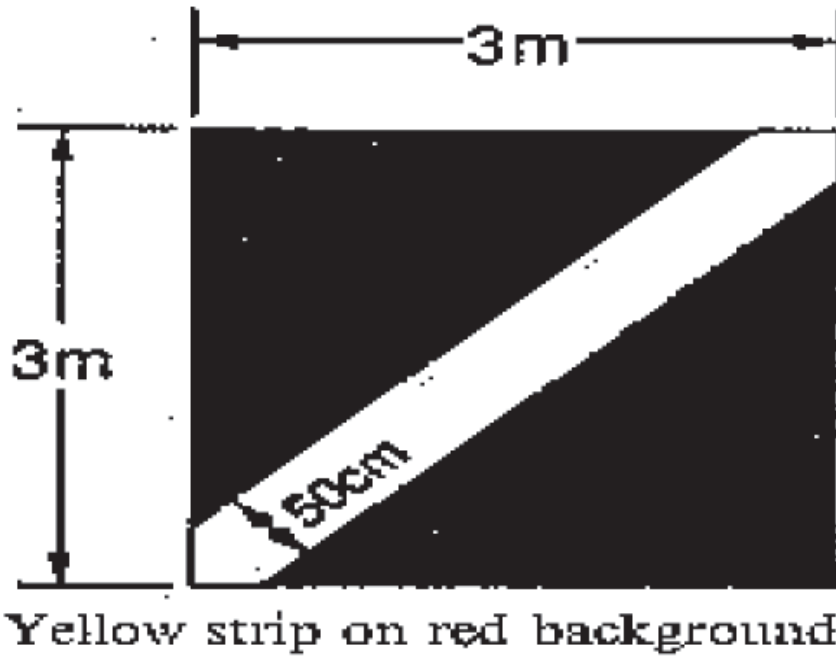
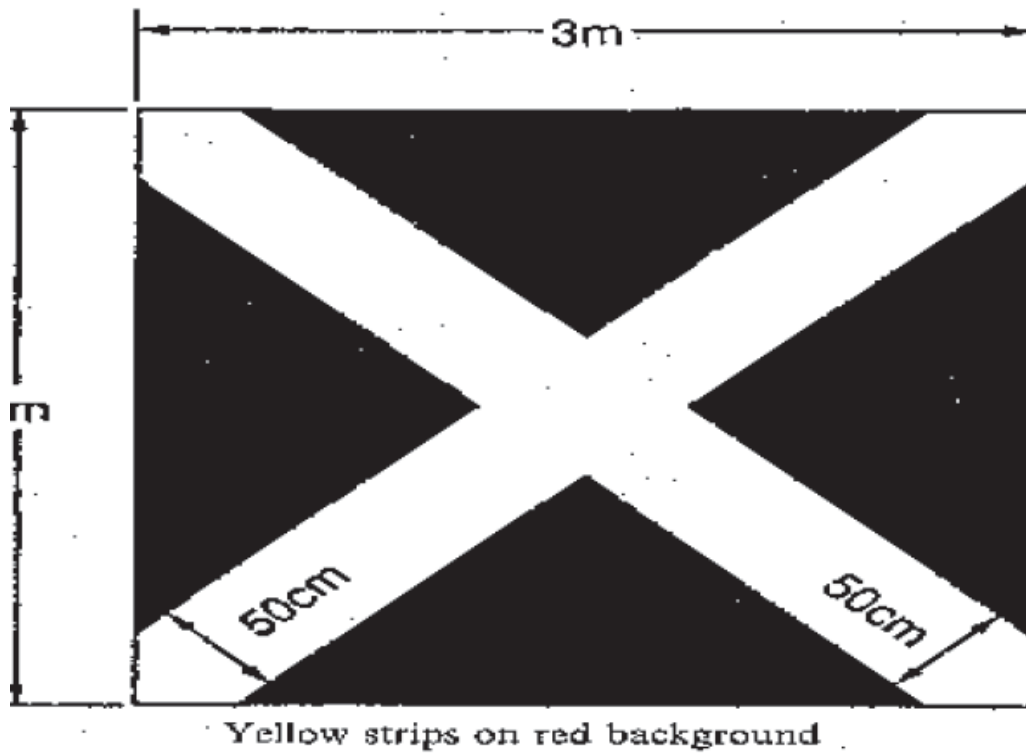

Fig. 6

signifies that the state of the manoeuvring area is poor and pilots must exercise special care when landing.

(7) A red panel 3 metres square with a yellow strip 50 centimetres wide along each diagonal, as illustrated in this paragraph,



Yellow strips on red background

Fig. 7

signifies that the aerodrome is unsafe for the movement of aircraft and that landing on the aerodrome is prohibited.

(8) A white letter H, as illustrated in this paragraph,

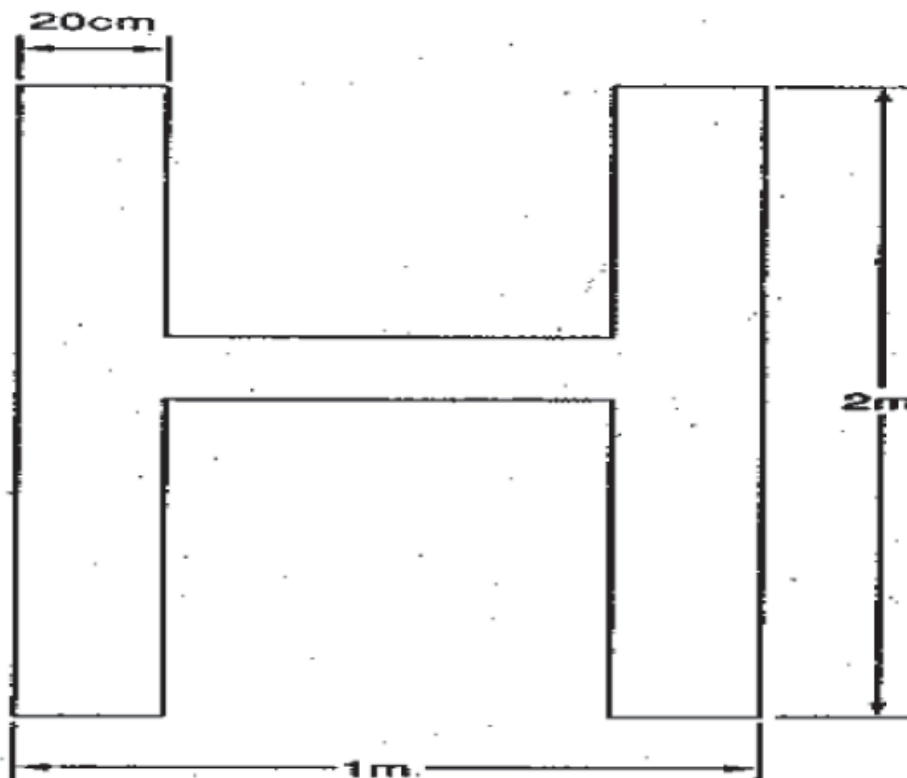

Fig. 8

signifies that helicopters shall take off and land only within the area designated by the marking specified in rule 59(7).

(9) A red letter L displayed on the dumb-bell specified in paragraphs (4) and (5), as illustrated in this paragraph,

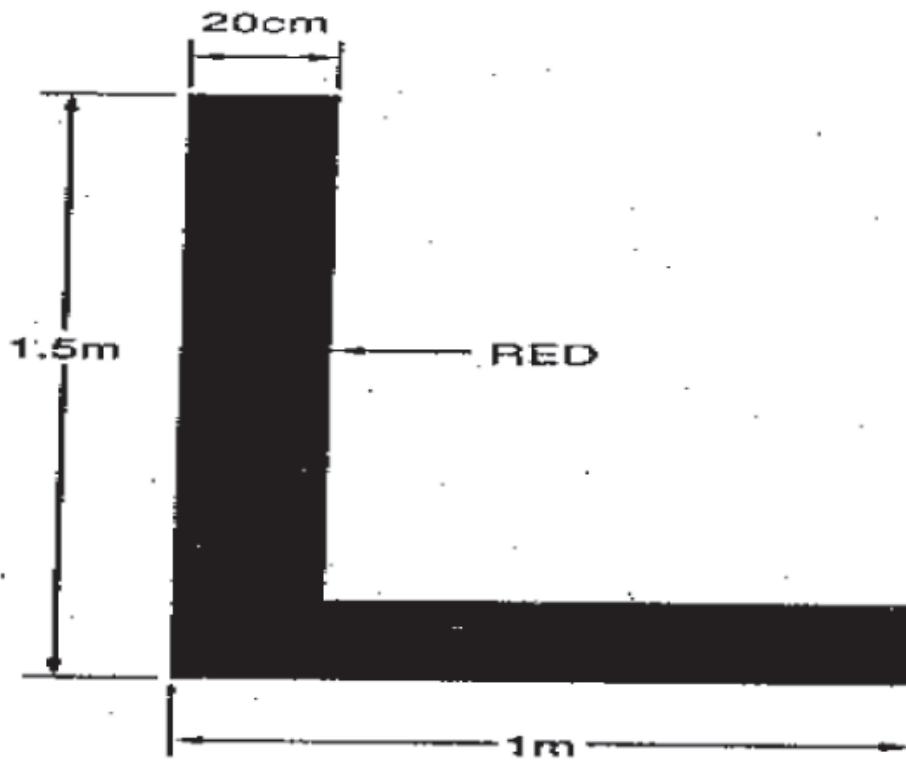
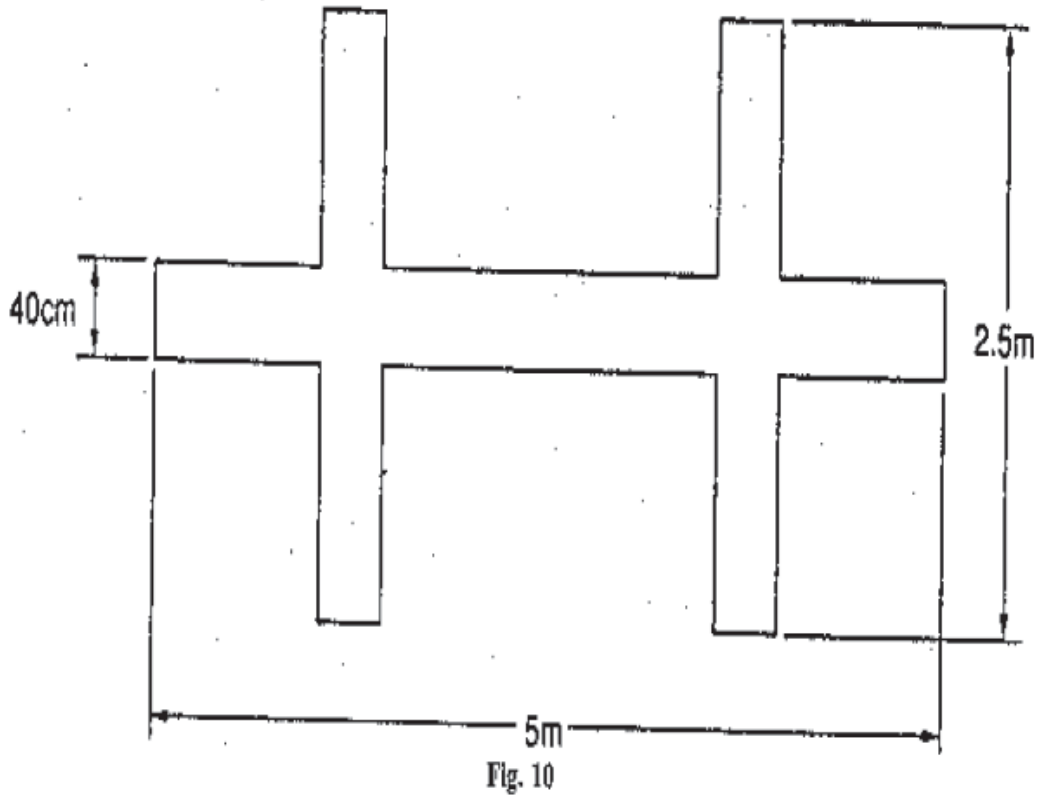

Fig. 9

signifies that light aircraft are permitted to take off and land either on a runway or on the area designated by the marking specified in rule 59(8).

(10) A white double cross, as illustrated in this paragraph,



signifies that glider flying is in progress.

Markings for paved runways and taxiways

58.—(1) Two or more white crosses, as illustrated in this paragraph,

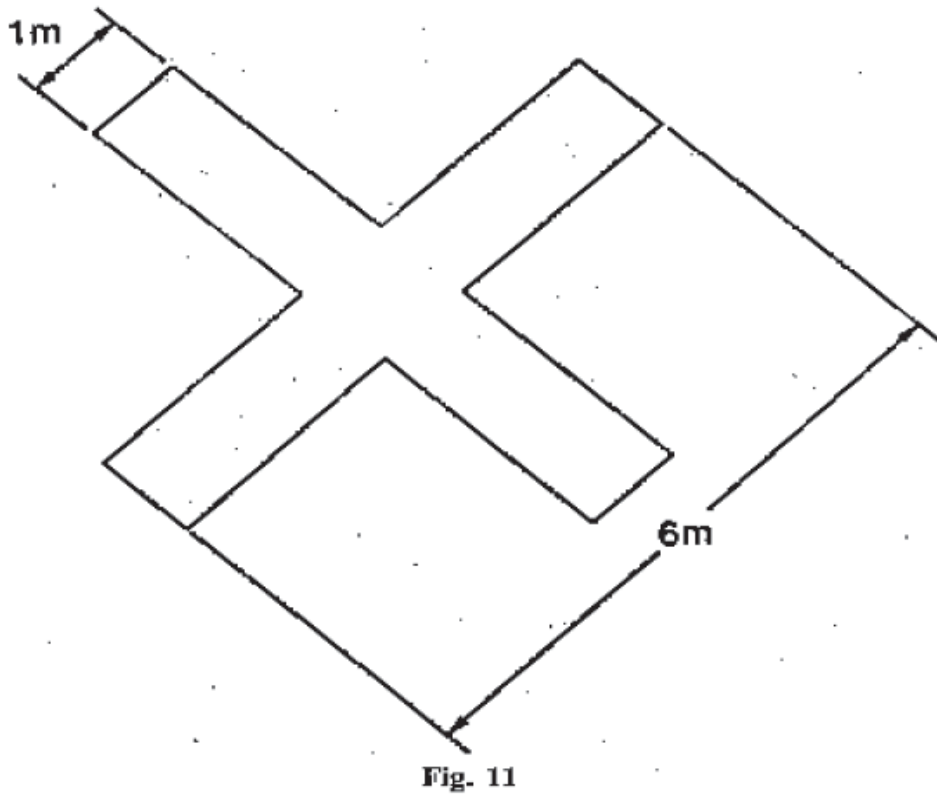

displayed on a runway or taxiway, with each arm of each cross at an angle of 45° to the centre line of the runway, at intervals of not more than 300 metres signify that the section of the runway or taxiway marked by them is unfit for the movement of aircraft.

(2) Subject to paragraph (3), two yellow broken lines and two continuous lines, as illustrated

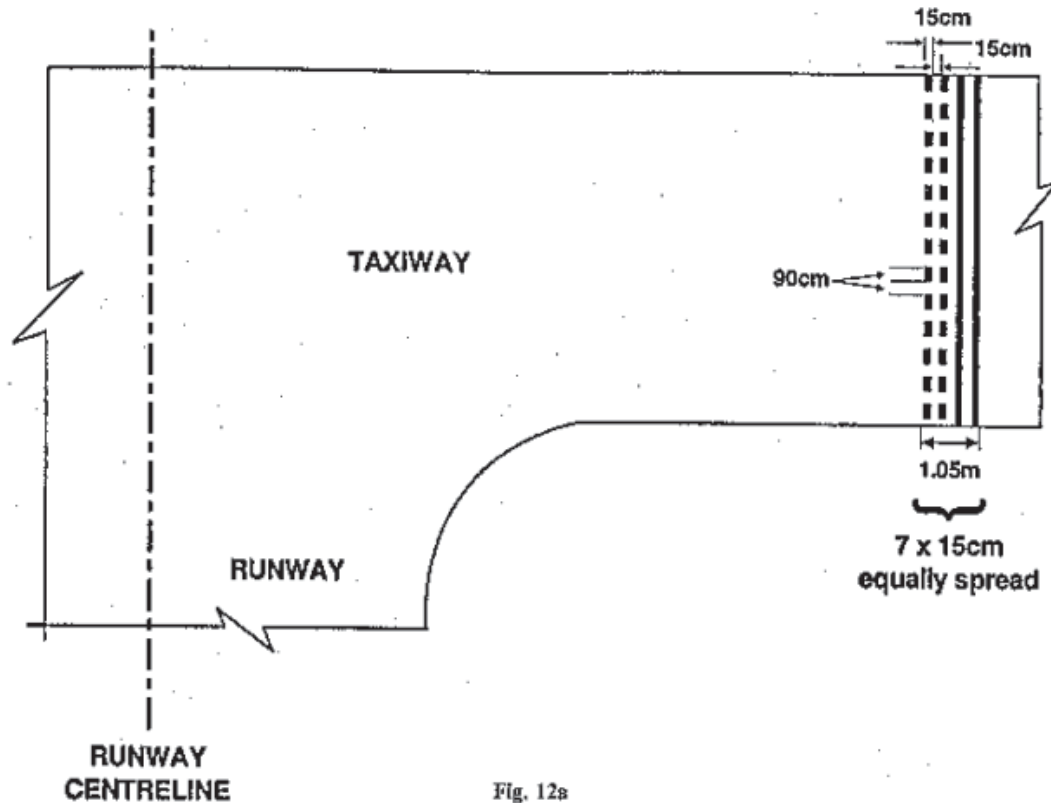

Fig. 12a

in this paragraph, signify the designated visual holding position associated with a runway beyond which no part of a flying machine or vehicle shall project in the direction of the runway without permission from the air traffic control unit at the aerodrome during the notified hours of watch of that unit.

(3) Outside the notified hours of watch of that unit or where there is no air traffic control unit at the aerodrome the markings referred to in paragraph (2) signify the position closest to the runway beyond which no part of a flying machine or vehicle shall project in the direction of the runway when the flying machine or vehicle is required by virtue of rule 42(3) to give way to aircraft which are taking off from or landing on that runway.

Subject to paragraph (5), a yellow marking, as illustrated in this paragraph,

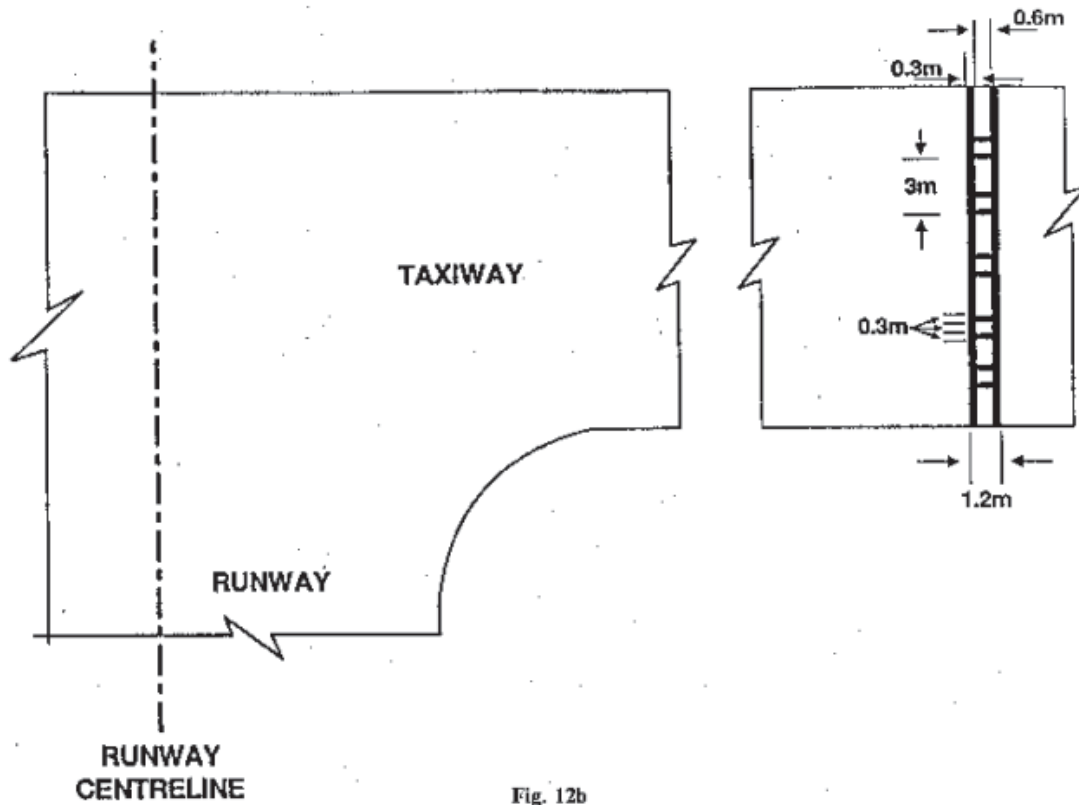

Fig. 12b

signifies a holding position other than that closest to the runway beyond which no part of a flying machine or vehicle shall project in the direction of the runway without permission from the air traffic control unit at the aerodrome during the notified hours of watch of that unit.

(4) Outside the notified hours of watch of that unit or where there is no air traffic control unit at the aerodrome the marking referred to in paragraph (4) may be disregarded.

(5) Orange and white markers, as illustrated in this paragraph,

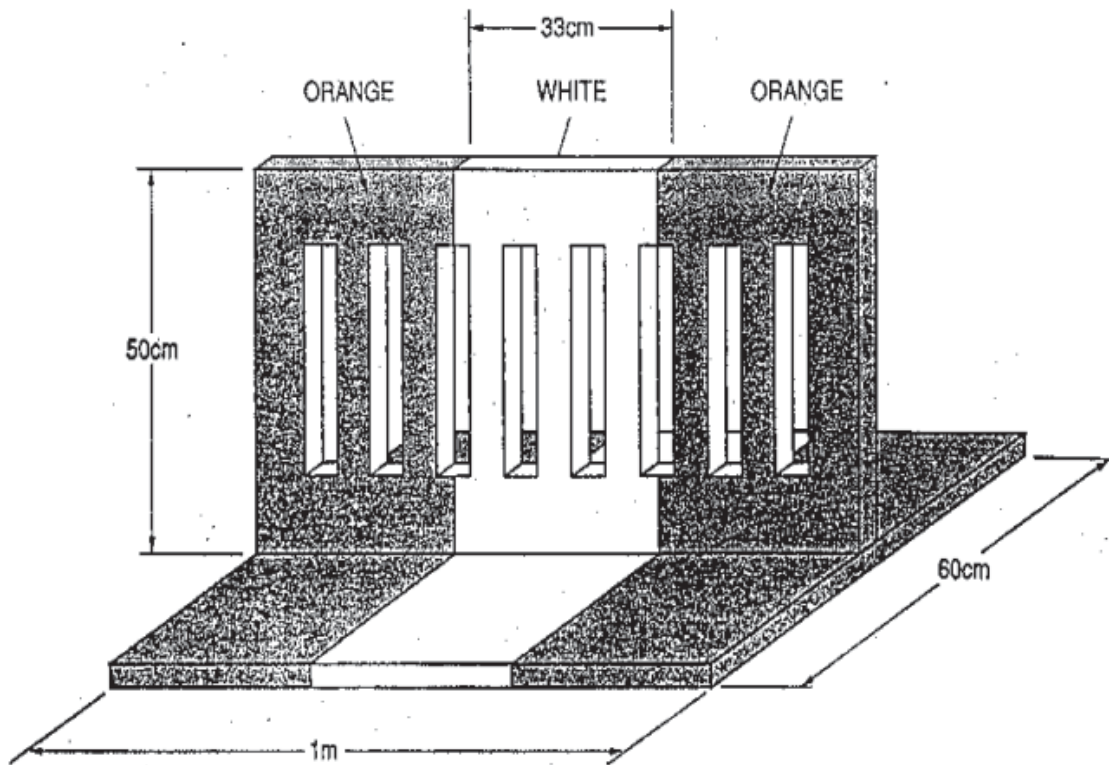

Fig. 13

spaced no more than 15 metres apart, signify the boundary of that part of a paved runway, taxiway or apron which is unfit for the movement of aircraft.

Markings on unpaved manoeuvring areas

59.—(1) Markers with orange and white stripes of an equal width of 50 centimetres, with an orange stripe at each end, alternating with flags 60 centimetres square showing equal orange and white triangular areas, spaced not more than 90 metres apart as illustrated in this paragraph,

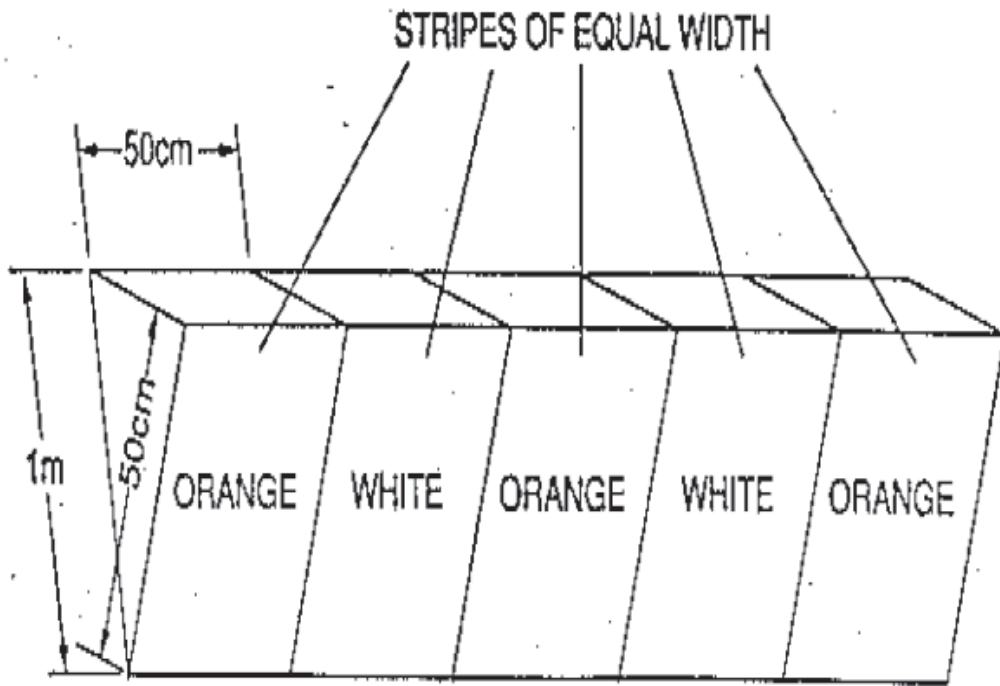

Fig. 14

indicate the boundary of an area unfit for the movement of aircraft.

(2) One or more white crosses, as specified in rule 58(1), also indicate such an area as is referred to in paragraph (1).

(3) Striped markers, as specified in paragraph (1), spaced not more than 45 metres apart, indicate the boundary of an aerodrome.

(4) On structures markers with orange and white vertical stripes, of an equal width of 50 centimetres, with an orange stripe at each end, spaced not more than 45 metres apart, as illustrated in this paragraph.

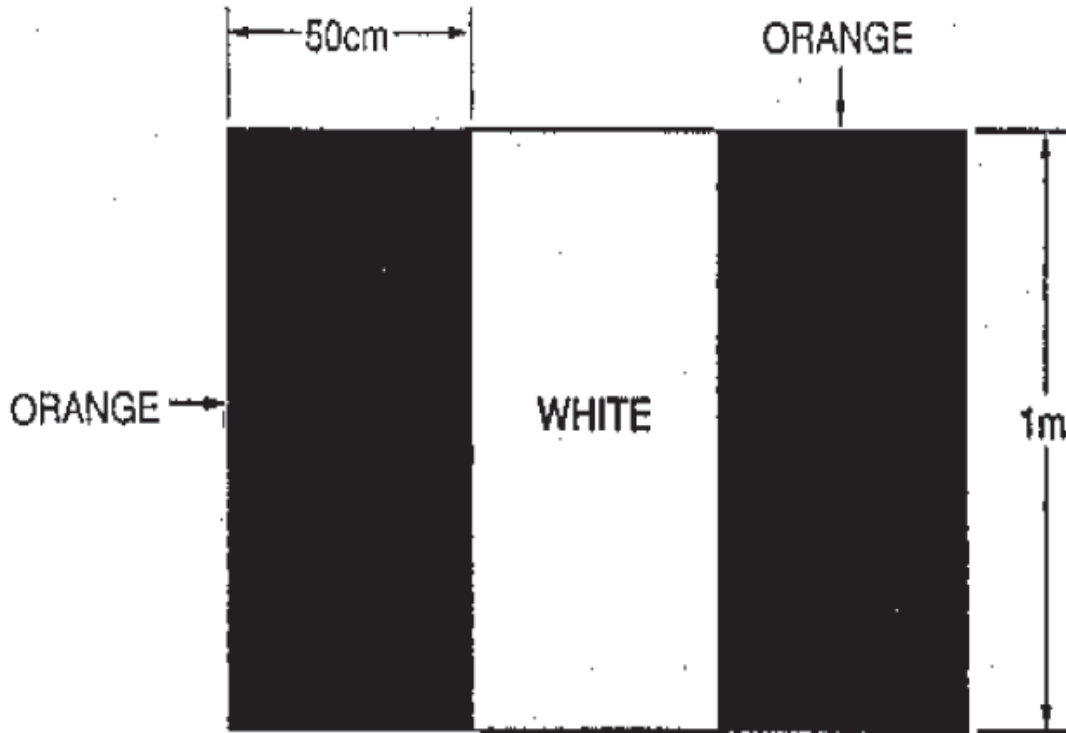

Fig. 15

indicate the boundary of an aerodrome.

(5) The pattern of the marker referred to in paragraph (4) shall be visible from inside and outside the aerodrome and the marker shall be affixed not more than 15 centimetres from the top of the structure.

(6) White, flat, rectangular markers 3 metres long and 1 metre wide, at intervals not exceeding 90 metres, flush with the surface of an unpaved runway or stopway, indicate the boundary of the unpaved runway or stopway.

(7) A white letter H, as illustrated in this paragraph,

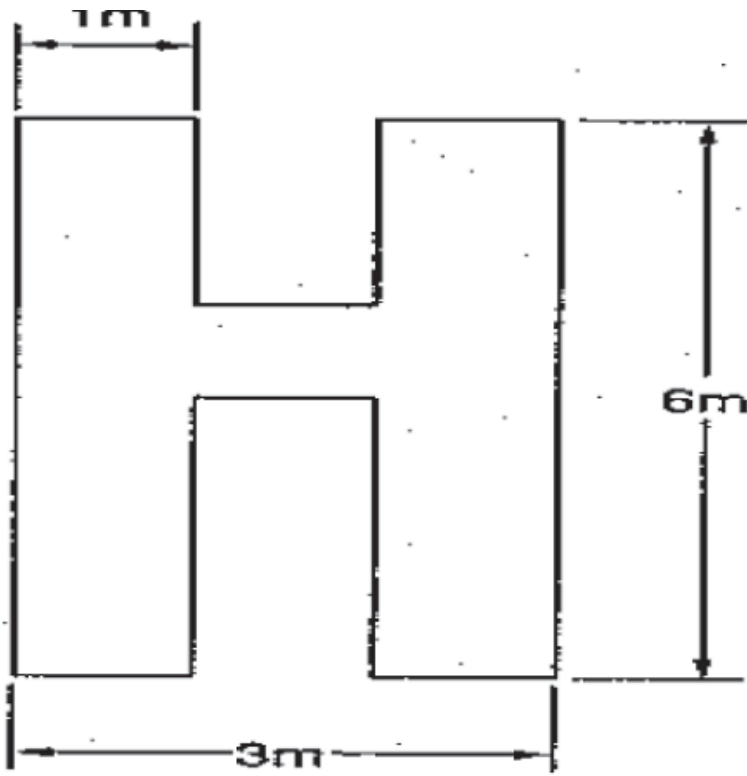

Fig. 16

indicates an area which shall be used only for the taking off and landing of helicopters.

(8) A white letter L, as illustrated in this paragraph,

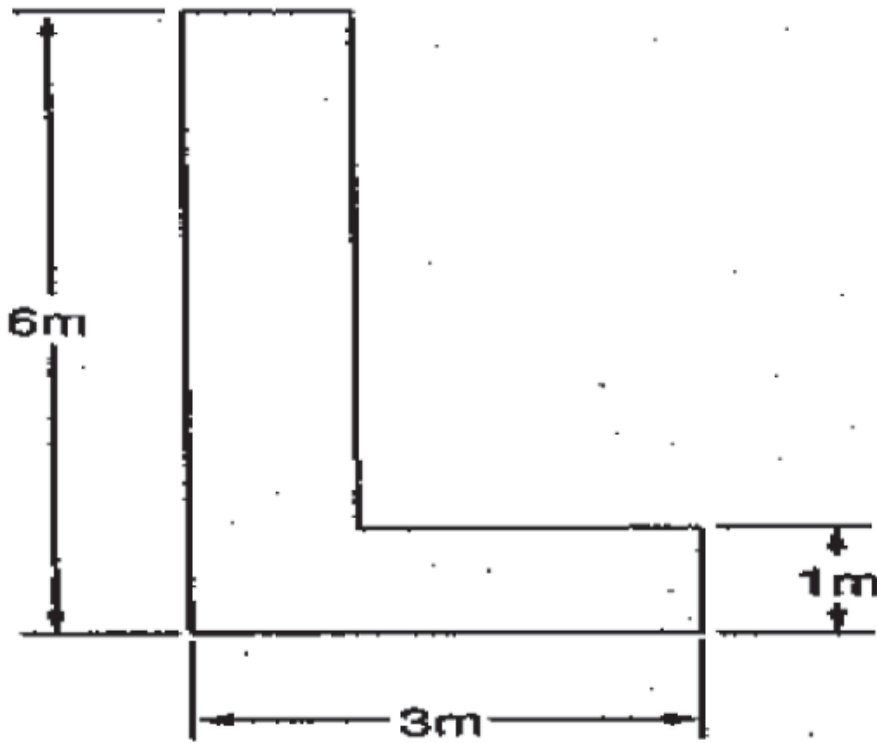

Fig. 17

indicates a part of the manoeuvring area which shall be used only for the taking off and landing of light aircraft.

(9) A yellow cross with two arms each 6 metres long by 1 metre wide at right angles, indicates that tow ropes, banners and similar articles towed by aircraft shall only be picked up and dropped in the area in which the cross is placed.

(10) A white double cross, as illustrated in this paragraph,

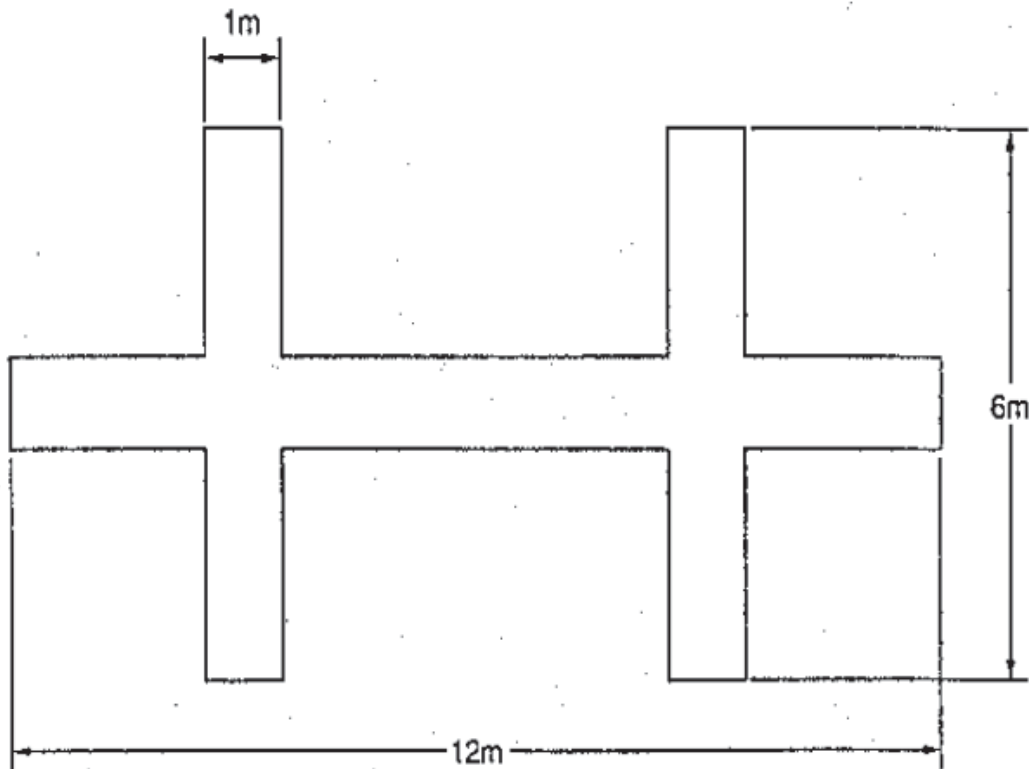

Fig. 18

indicates an area which shall be used only for the taking off and landing of gliders.

(11) Subject to paragraph (12) a white landing T, as specified in rule 57(2), placed at the left-hand side of the runway (when viewed from the direction of landing) indicates the runway to be used for take-off and landing.

(12) The white landing T referred to in paragraph (11), when placed at an aerodrome with no runway, indicates the direction for take-off and landing.

Signals visible from the ground

60.—(1) A black ball, 60 centimetres in diameter, suspended from a mast signifies that the directions of take off and landing are not necessarily the same.

(2) A chequered flag or board, 1.2 metres by 90 centimetres, containing 12 equal squares, 4 horizontally and 3 vertically, coloured red and yellow alternately, signifies that aircraft may move on the manoeuvring area and apron only in accordance with the permission of the air traffic control unit at the aerodrome.

(3) Two red balls, 60 centimetres in diameter, positioned vertically one above the other, 60 centimetres apart and suspended from a mast, signify that glider flying is in progress at the aerodrome.

(4) Black, Arabic numerals in two-figure groups and, where parallel runways are provided, the letter or letters L (left), LC (left centre), C (centre), RC (right centre) and R (right), placed against a yellow background, indicate the direction for take-off or the runway in use.

(5) A black letter C against a yellow background, as illustrated in this paragraph,

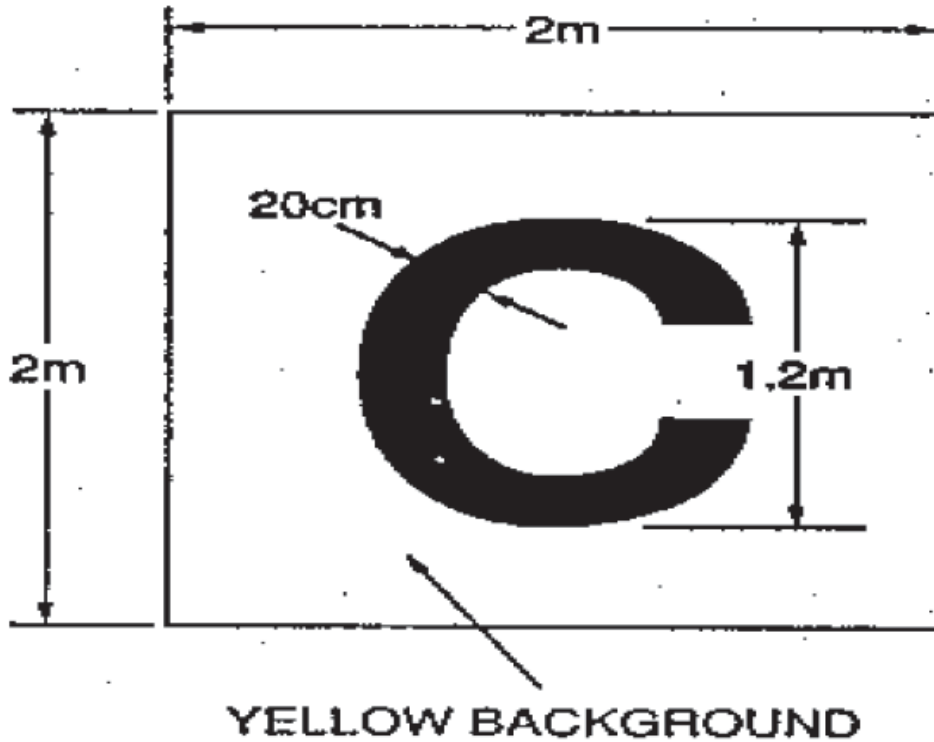

Fig. 19

indicates the position at which a pilot can report to the air traffic control unit or to the person in charge of the aerodrome.

(6) A rectangular green flag of not less than 60 centimetres square and not more than 66 centimetres square, flown from a mast, indicates that a right-hand circuit is in force.

Lights and pyrotechnic signals for control of aerodrome traffic

61. Each signal described in column 1 of Table 4 shall have the meanings respectively appearing in columns 2, 3 and 4 of the Table in the circumstances specified in the second row of the Table.

Table 4—Meaning Of Lights And Pyrotechnic Signals

<i>Column 1</i>	<i>Column 2</i>	<i>Column 3</i>	<i>Column 4</i>
<i>Characteristic and colour of light beam or pyrotechnic</i>	<i>Directed from an aerodrome to an aircraft in flight</i>	<i>Directed from an aerodrome To an aircraft or vehicle on the aerodrome</i>	<i>Directed from an aircraft in flight to an aerodrome</i>
(a) Continuous red light.	Give way to other aircraft and continue circling.	Stop.	—
(b) Red pyrotechnic light, or red flare.	Do not land; wait for permission.	—	Immediate assistance is required.
(c) Red flashes.	Do not land; aerodrome not available for landing.	Move clear of landing area.	—
(d) Green flashes.	Return to aerodrome; wait for permission to	To an aircraft: you may move on the	—

	land.	manoeuvring area and apron. To a vehicle: you may move on the manoeuvring area.	
(e) Continuous green light.	You may land.	You may take off (not applicable to a vehicle).	—
(f) Continuous green light, or green flashes, or green pyrotechnic light.	—	—	By night: May I land? By day: May I land from direction different from that indicated by landing T?
(g) White flashes.	Land at the aerodrome after receiving continuous green light, and then, after receiving green flashes, proceed to the apron.	Return to starting point on the aerodrome.	I am compelled to land.
(h) White pyrotechnic lights. Switching on and off the navigation lights. Switching on and off the landing lights.	—	—	I am compelled to land.

Marshalling signals (from a marshaller to an aircraft)

62.—(1) Each of the signals for the guidance of aircraft manoeuvring on or off the ground, described in column 1 of Table 5 and as illustrated in column 3, when given by a marshaller to an aircraft, shall have the meanings specified in column 2 of the Table.

(2) By day any such signals shall be given by hand or by circular bats and by night shall be given by torches or by illuminated wands.

Table 5—Meaning of Marshalling Signals (from a marshaller to an aircraft)

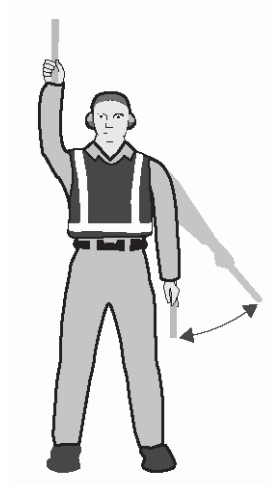
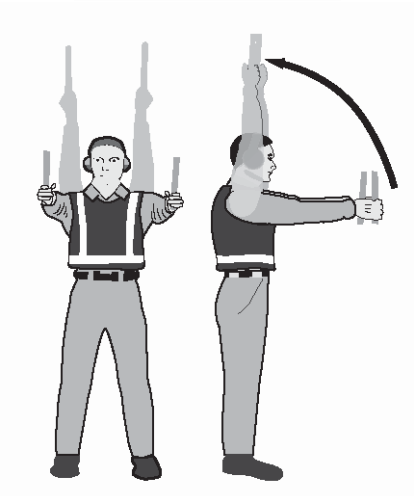
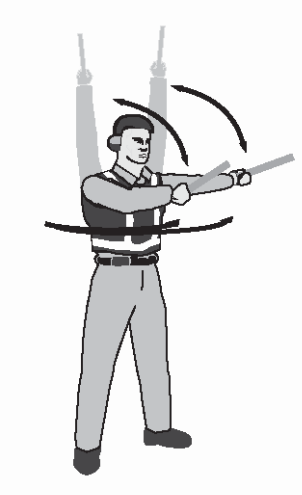
<i>Column 1</i>	<i>Column 2</i>	<i>Column 3</i>
<i>Description of Signal</i>	<i>Meaning of signal</i>	<i>Illustration of signal</i>
<p>1. Raise right hand above head level with wand pointing up; move left-hand wand pointing down toward body.</p>	<p>Wingwalker/guide — This signal provides an indication by a person positioned at the aircraft wing tip, to the pilot/marshaller/ push-back operator, that the aircraft movement on/off a parking position would be unobstructed.</p>	
<p>2. Raise fully extended arms straight above head with wands pointing up</p>	<p>Identify gate</p>	
<p>3. Point both arms upward, move and extend arms outward to sides of body and point with wands to direction of next signalman or taxi area.</p>	<p>Proceed to next signalman or as directed by tower/ground control</p>	

4. Bend extended arms at elbows and move wands up and down from chest height to head.

Straight ahead



5(a) With right arm and wand extended at a 90-degree angle to body, make “come ahead” signal with left hand. The rate of signal motion indicates to pilot the rate of aircraft turn.

Turn left (from pilot’s point of view)

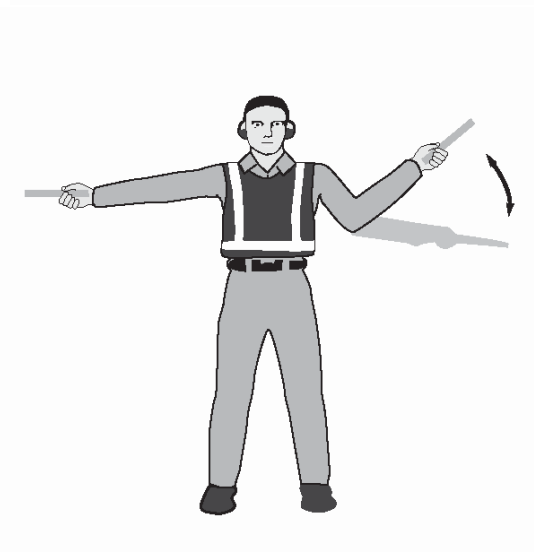

5(b) With left arm and wand extended at a 90-degree angle to body, make “come ahead” signal with right hand. The rate of signal motion indicates to pilot the rate of aircraft turn.

Turn right (from pilot’s point of view)

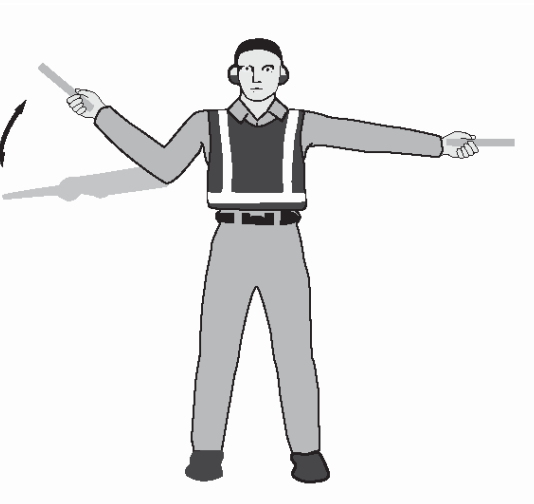

6(a) Fully extend arms and wands at a 90-degree angle to sides and slowly move to above head until wands cross.

Normal stop

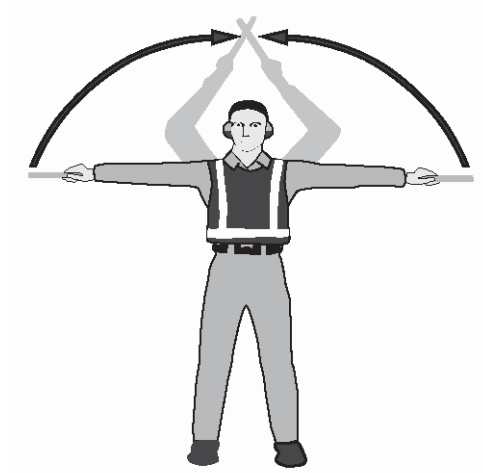

6(b) Abruptly extend arms and wands to top of head, crossing wands.

Emergency stop

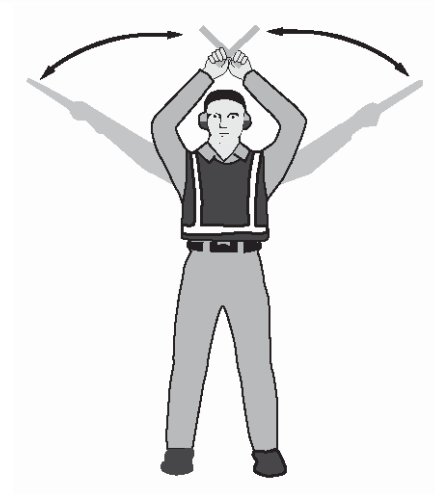

7(a) Raise hand just above shoulder height with open palm. Ensuring eye contact with flight crew, close hand into a fist. Do Not move until receipt of "thumbs up" acknowledgement from flight crew.

Set brakes



7(b) Raise hand just above shoulder height with hand closed in a fist. Ensuring eye contact with flight crew, open palm. Do not move until receipt of “thumbs up” acknowledgement from crew.

Release brakes

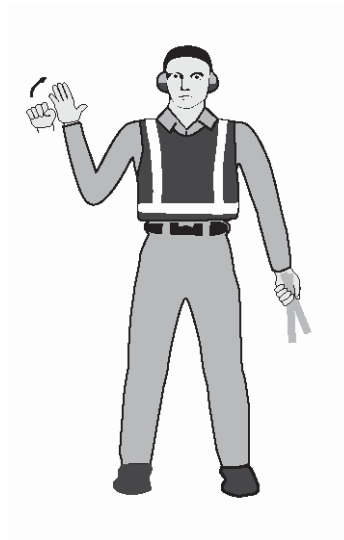

8(a) With arms and wands fully extending above head, move wands inwards in a “jabbing” motion until wands touch. Ensure acknowledgement is received from flight crew.

Chocks inserted



8(b) With arms and wands fully extended above head, move wands outward in “jabbing” motion. Do not remove chocks until authorised by crew.

Chocks removed



9. Raise right arm to head level with wand pointing up and start a circular motion with hand; at the same time, with left arm raised above head level, point to engine to be started.

Start engine(s)



10. Extend arm with wand forward of body at shoulder level; move hand and wand to top of left shoulder and draw wand to top of right shoulder in a slicing motion across throat.

Cut engine(s)

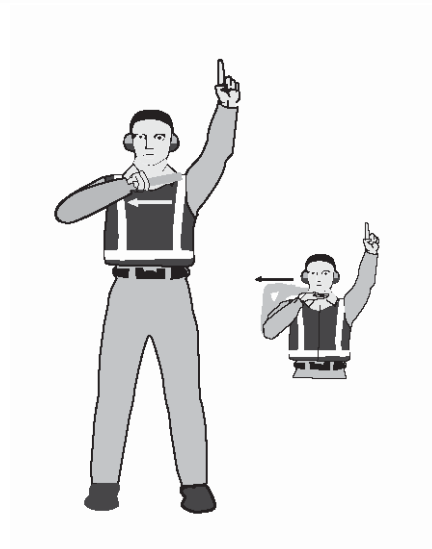

11. Move extended arms downwards in a "patting" gesture, moving wands up and down from waist to knees.

Slow down



12. With arms down and wands toward ground, wave either right or left wand up and down indicating engine(s) on left or right side respectively should be slowed down.

Slow down engine(s) on indicated side

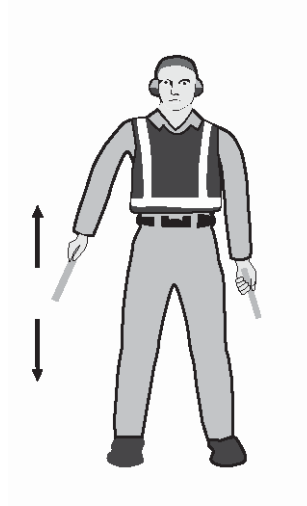

13. With arms in front of body at waist height, rotate arms in a forward motion. To stop rearward movement, use signal 6(a) or 6(b).

Move Back



14(a) Point left arm with wand down and bring right arm from overhead vertical position to horizontal forward position, repeating right-arm movement.

Turns while backing (for tail to starboard)



14(b) Point right arm with wand down and bring left arm from overhead vertical position to horizontal position, repeating left-arm movement.

Turns while backing (for tail to port)



15. Raise right arm to head level with wand pointing up or display hand with “thumbs up”; left arm remains at side by knee.

Affirmative/all clear—
This signal is also used as a technical/servicing communication signal.

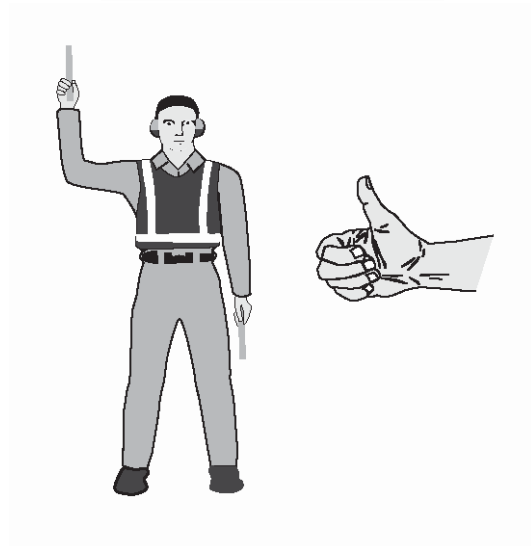

16. Fully extend arms and wands at a 90-degree angle to sides.

Hover

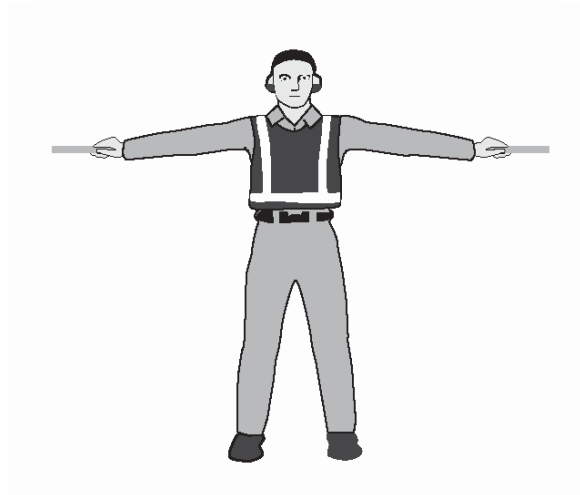

17. Fully extend arms and wands at a 90-degree angle to sides and, with palms turned up, move hands upwards. Speed of movement indicates rate of ascent.

Move upwards

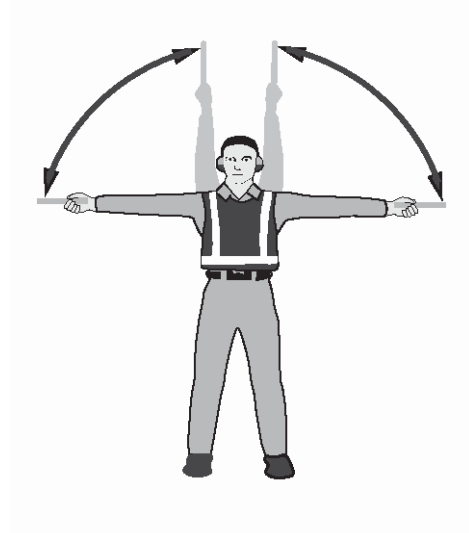

18. Fully extend arms and wands at a 90-degree angle to sides and, with palms turned down, move hands downwards. Speed of movement indicates rate of descent.

Move downwards

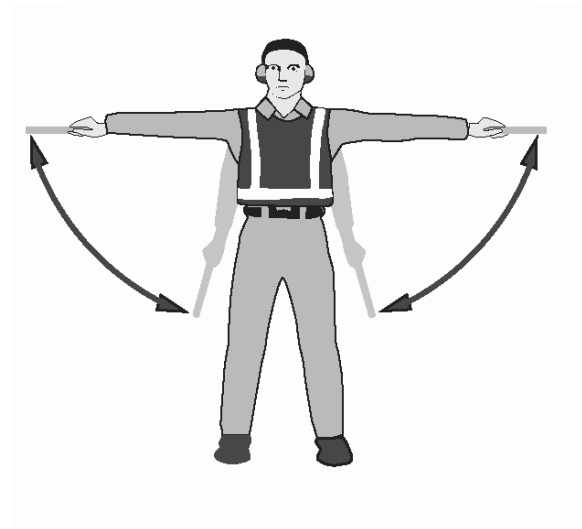

19(a) Extend arm horizontally at a 90-degree angle to right side of body. Move other arm in same direction in a sweeping motion.

Move horizontally left
(from pilot's point of view)

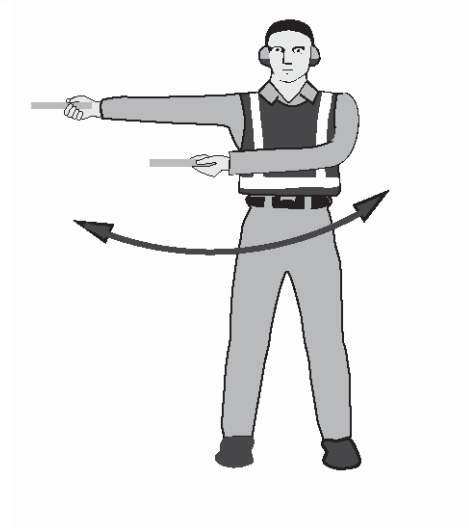

19(b) Extend arm horizontally at a 90-degree angle to left side of body. Move other arm in same direction in a sweeping motion.

Move horizontally right (from pilot's point of view)

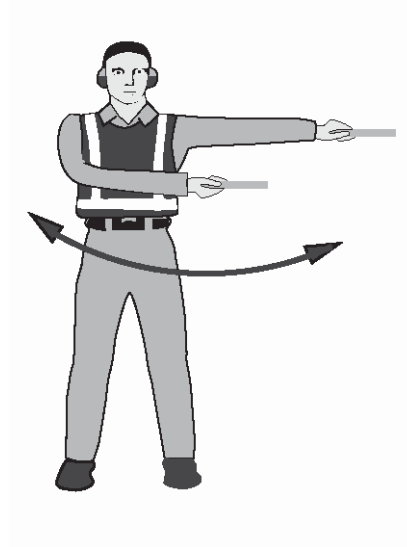

20. Cross arms with wands downwards and in front of body.

Land

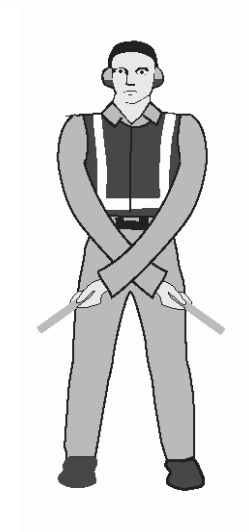

21. Move right-hand wand in a "fanning" motion from shoulder to knee, while at the same time pointing with left-hand wand to area of fire.

Fire

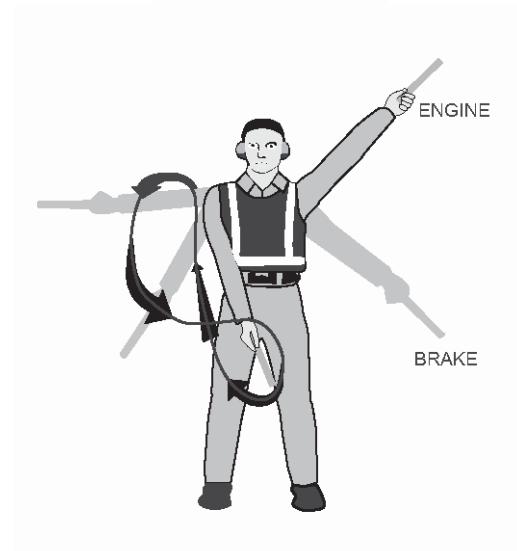

22. Fully extend arms and wands downwards at a 45-degree angle to sides. Hold position until aircraft is clear for next manoeuvre.

Hold position/stand by

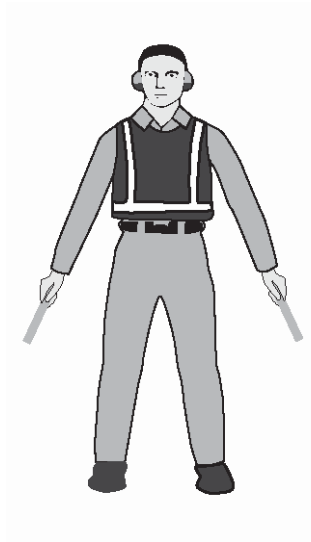

23. Perform a standard salute with right hand and/or wand to dispatch the aircraft. Maintain eye contact with flight crew until aircraft has begun to taxi.

Dispatch aircraft

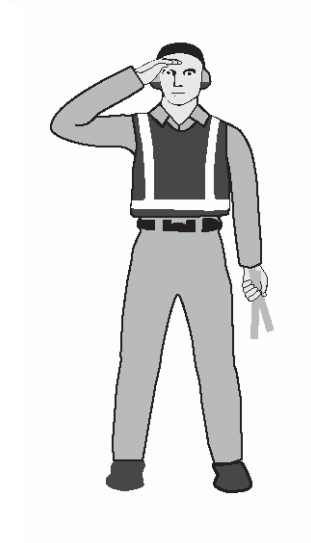

24. Extend right arm fully above head and close fist or hold wand in horizontal position; left arm remains at side by knee.

Do not touch controls
(technical/servicing
communication signal)

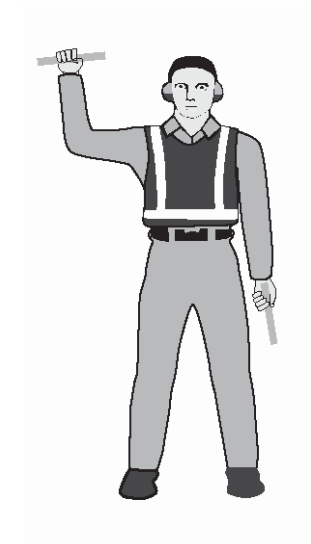

25. Hold arms fully extended above head, open left hand horizontally and move finger tips of right hand into a touch open palm of left hand (forming a “T”). At night, illuminated wands can also be used to form the “T” above head.

Connect ground power
(technical/servicing
communication signal)

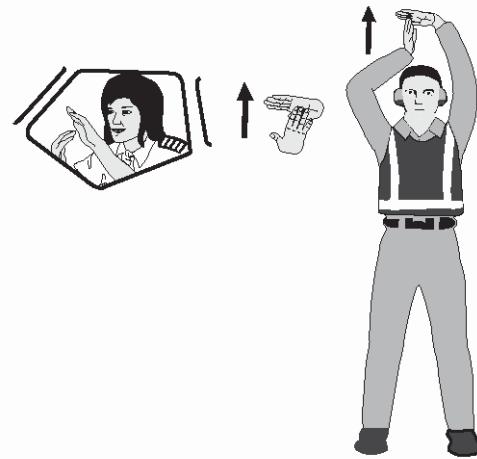

26. Hold arms fully extended above head with finger tips of right hand touching open horizontal palm of left hand (forming a “T”); then move right hand away from the left. Do not disconnect power until authorised by flight crew. At night illuminated wands can also be used to form the “T” above head.

Disconnect power
(technical/servicing
communication signal)

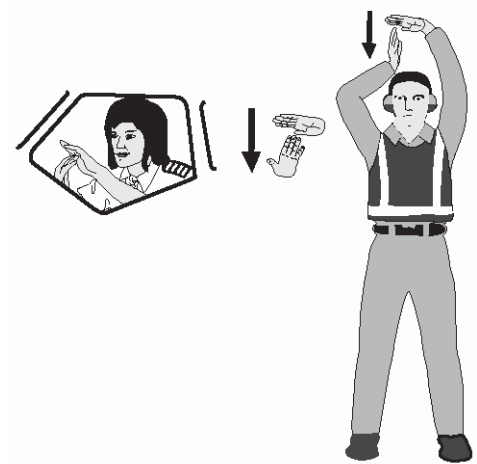

27. Hold right arm straight out at 90 degrees from shoulder and point wand down to ground or display hand with “thumbs down”; left hand remains at side by knee.

Negative
(technical/servicing
communication signal)

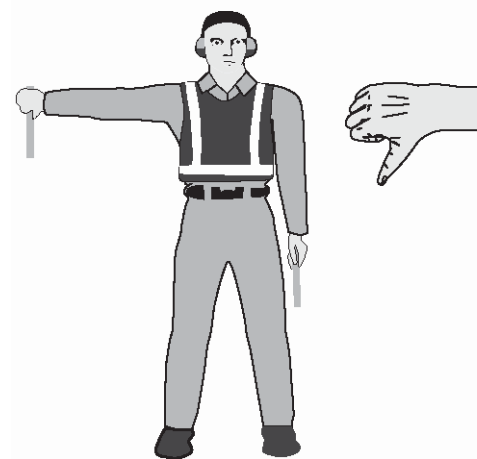

28. Extend both arms at 90 degrees from body and move hands to cup both ears.

Establish communication via interphone (technical/servicing communication signal)

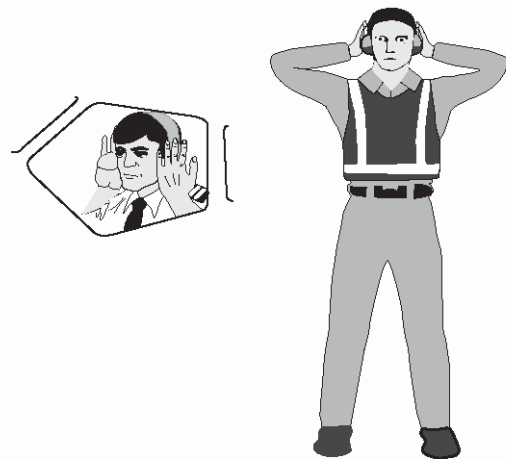

29. With right arm at side and left arm raised above head at a 45-degree angle, move right arm in a sweeping motion towards top of left shoulder.

Open/close stairs (technical/servicing communication signal)—This signal is intended mainly for aircraft with the set of integral stairs at the front

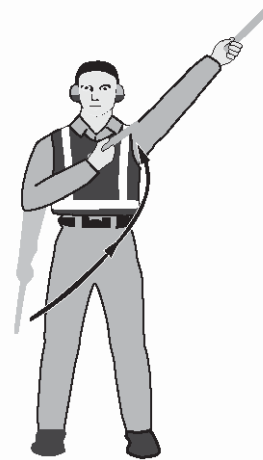

Marshalling signals (from a pilot of an aircraft to a marshaller)

63. Each of the signals described in column 1 of Table 6, when made by a pilot in an aircraft to a marshaller on the ground, shall have the meanings specified in column 2 of the Table:

Table 6—Meaning of Marshalling Signals (from a pilot of an aircraft to a marshaller)

<i>Column 1</i>	<i>Column 2</i>
<i>Description of Signal</i>	<i>Meaning of Signal</i>
1. Raise arm and hand with fingers extended horizontally in front of face, then clench fist.	Brakes engaged.
2. Raise arm with fist clenched horizontally in front of face, then extend fingers.	Brakes released.
3. Arms extended palms facing outwards, move hands inwards to cross in front of face.	Insert chocks.
4. Hands crossed in front of face, palms facing outwards, move arms outwards.	Remove chocks.
5. Raise the number of fingers on one hand indicating the number of the engine to be started. For this purpose the aircraft engines shall be numbered in relation to the marshaller facing the aircraft, from his right to his left. For example, No. 1 engine shall be the port outer engine, No. 2 engine shall be the port inner engine, No. 3 engine shall be the starboard inner engine and No. 4 engine shall be the starboard outer engine.	Ready to start engines.

Distress, urgency and safety signals

64.—(1) The following signals, given either together or separately before the sending of a message, signify that an aircraft is threatened by grave and imminent danger and requests immediate assistance—

- (a) by radiotelephony—
the spoken word ‘MAYDAY’;
- (b) by visual signalling—
 - (i) the signal SOS (... --- ...);
 - (ii) a succession of pyrotechnic lights fired at short intervals each showing a single red light;
 - (iii) a parachute flare showing a red light;
- (c) by sound signalling other than radiotelephony—
 - (i) the signal SOS (... --- ...);
 - (ii) a continuous sounding with any sound apparatus.

(2) The following signals, given either together or separately, before the sending of a message, signify that the commander of the aircraft wishes to give notice of difficulties which compel it to land but that he does not require immediate assistance—

- (a) a succession of white pyrotechnic lights;
- (b) the repeated switching on and off of the aircraft landing lights;
- (c) the repeated switching on and off of its navigation lights, in such a manner as to be clearly distinguishable from the flashing navigation lights described in rule 49.

(3) The following signals, given either together or separately, indicate that the commander of the aircraft has an urgent message to transmit concerning the safety of a ship, aircraft, vehicle or other property or of a person on board or within sight of the aircraft from which the signal is given:

- (a) by radiotelephony—
the repeated spoken word, ‘PAN PAN’;
- (b) by visual signalling—
the signal XXX (- .. -- .. -- .. -);
- (c) by sound signalling other than radiotelephony—
the signal XXX (- .. -- .. -- .. -).

SCHEDULE 2

Regulation 3

REVOCATIONS

<i>Regulations revoked</i>	<i>Reference</i>
The Rules of the Air Regulations 1996	S.I. 1996/1393
The Rules of the Air (Amendment) Regulations 1999	S.I. 1999/1323
The Rules of the Air (Amendment) Regulations 2000	S.I. 2000/1994
The Rules of the Air (Amendment) Regulations 2001	S.I. 2001/917
The Rules of the Air (Amendment) Regulations 2003	S.I. 2003/64
The Rules of the Air (Amendment) Regulations 2005	S.I. 2005/1110

EXPLANATORY NOTE

(This note is not part of the Regulations)

These Regulations revoke and replace the Rules of the Air Regulations 1996, as amended. In addition to some minor drafting amendments, the following changes are made:

1. The exemption from the 500 ft rule for aircraft taking-off or landing in accordance with normal aviation practice is extended to aircraft that are air-taxiing (which is defined). (Rule 6(a)(ii)).

2. VFR flight in Class C airspace above flight level 195 or along a Class C ATS route (which is defined) at any level is prohibited unless authorised by the Civil Aviation Act 1982. (Rule 19).

3. The filing of a flight plan for a VFR flight above flight level 195 or to fly under VFR along a Class C ATS route at any level is prohibited. (Rule 29(4)).

4. A helicopter flying under the Visual Flight Rules in Class C, Class D or Class E airspace at or below 3,000 feet above mean sea level must keep the surface in sight and in a flight visibility of at least 1,500 metres except where the helicopter is air-taxiing or conducting manoeuvres in accordance with Rule 6(i). (Rule 27).

5. A helicopter flying under the Visual Flight Rules outside controlled airspace below 3,000 feet above mean sea level must keep the surface in sight and in a flight visibility of at least 1,500 metres except where a helicopter is air taxiing or conducting manoeuvres in accordance with Rule 6(i). (Rule 28).

6. An aircraft may fly at a height of less than 1,000 feet above the highest obstacle within a distance of five nautical miles of the aircraft if it is flying at a altitude not exceeding 3,000 feet above mean seal level and remains clear of cloud with the surface in sight and in a flight visibility of at least 800 metres. (Rule 33).

7. References in the Rules to “in sight of the surface” or “in sight of the ground” have been replaced by “with the surface in sight” which is defined in article 155(1) of the Air Navigation Order 2005.

A regulatory impact assessment in respect of these changes has been produced and a copy placed in the library and a copy placed in the library of both Houses of Parliament. Copies may be obtained from the Department for Transport, Great Minster House, 76 Marsham Street, London SW1P 4DR. Alternatively copies can be obtained from the Department’s website which is www.dft.gov.uk.

© Crown copyright 2007

Printed and published in the UK by The Stationery Office Limited
under the authority and superintendence of Carol Tullo, Controller of Her Majesty's
Stationery Office and Queen's Printer of Acts of Parliament.

E0371 3/2007 170371T 19585

