

SCHEDULE 9

Regulation 3, Direction 3

Regulatory signs at junctions and miscellaneous regulatory signs

**PART 1**



Provisions applicable to signs in Part 2

1. The information or requirement of a description in column 2 of an item in the sign table in Part 2 must be conveyed by a sign that is —
  - (a) of the colour and type shown in the diagram in column 3; and
  - (b) complies with the requirements as to size given in column 4.
2. A provision of Part 8 applies to a sign provided for in Part 2 where indicated in column 5 of the Part 2 sign table (by reference to a paragraph number in Part 8).
3. A Schedule 9 General Direction applies to a sign provided for in Part 2 where indicated in column 6 of the Part 2 sign table (by reference to a number equivalent to the general direction in Part 9).



**PART 2**

Signs at junctions

**Sign table — Schedule 9, Part 2**

(1)	(2)	(3)	(4)	(5)	(6)
	<i>Item Description</i>	<i>Diagram</i>	<i>Permitted sizes</i>	<i>Applicable provisions in Part 8</i>	<i>Schedule 9 General Directions</i>
1	Diagram 601.1 Vehicular traffic must comply with the requirements specified in paragraph 1 or 2 of Part 7		Sign height 750, 900, 1200	1, 2, 7	3, 4, 8
2	Diagram 602 Vehicular traffic must comply with the requirements specified in paragraph 3 or 4 of Part 7		Sign height 600, 750, 900, 1200, 1500	1, 7	5, 8
3	Diagram 608 Dual carriageway road (associated plate for items 1 and 2)		x-height of legend: 50, 62.5, 75, 100, 125		10

**Status:** This is the original version (as it was originally made). This item of legislation is currently only available in its original format.

(1)	(2)	(3)	(4)	(5)	(6)
	<i>Item Description</i>	<i>Diagram</i>	<i>Permitted sizes</i>	<i>Applicable provisions in Part 8</i>	<i>Schedule 9 General Directions</i>
4	Diagram 778 Open railway level crossing without light signals (associated plate for item 2)		Sign height 420, 525, 630		11
5	Diagram 778.1 Open tramway level crossing without light signals (associated plate for item 2)		Sign height 300, 375, 450		11
6	Diagram 611.1 Vehicles entering the junction must comply with the requirements prescribed in paragraph 5 of Part 7		Sign height 600, 750, 900	1, 3, 7	6, 8

### PART 3

#### Provisions applicable to signs in Part 4

1. The information or requirement of a description in column 2 of an item in the sign table in Part 4 must be conveyed by a sign that is—

- (a) of the colour and type; and
- (b) complies with the requirements as to size,

provided for in the diagram in column 3 at that item, or that diagram as varied in accordance with column 4.

2. A provision of Part 8 applies to a sign provided for in Part 4 where indicated in column 5 of the sign table (by reference to a paragraph number in Part 8).

3. A Schedule 9 General Direction applies to a sign provided for in Part 4 where indicated in column 6 (by reference to a number equivalent to the general direction in Part 9).

**Status:** This is the original version (as it was originally made). This item of legislation is currently only available in its original format.





## PART 4

### Other regulatory signs

Sign table — Schedule 9, Part 4

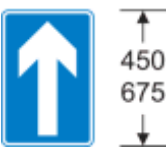
(1) Item	(2) Description	(3) Diagram	(4) Permitted variants	(5) Applicable provisions in Part 8	(6) Schedule provisions in General Directions
1	Diagram 651  Use of verge maintained in mown or ornamental condition by specified traffic prohibited		1. "animals", or the right hand symbol and "pedestrians", may be omitted, or that symbol and both words may be omitted 100 min 200 max 2. The arrow may be varied to point horizontally to the right, or may be omitted	8	1, 13
2	Diagram 626.2A  Vehicles exceeding the maximum gross weight indicated prohibited from crossing the bridge or other structure with exemption for empty vehicles		1. "18t" may be varied to "3t", "7.5t", "10t", "13t", "26t" or "33t" 80 80 100 120 2. "WEAK BRIDGE" may be varied to "WEAK ROAD" 3. The bottom panel may be omitted 50 62.5 75	1, 7	2
3	Diagram 622.10  Vehicles carrying dangerous goods within the tunnel restriction code indicated by the sign prohibited		The tunnel restriction code letter "B" may be varied to "C", "D" or "E" as appropriate	7	1



**Status:** This is the original version (as it was originally made). This item of legislation is currently only available in its original format.

(1) Item	(2) Description	(3) Diagram	(4) Permitted variants	(5) Applicable provisions in Part 8	(6) Schedule 8 General Directions
4	Diagram 784.1  Drivers of large or slow vehicles must stop and telephone in accordance with the provisions of paragraph 6 of Part 7 before using a level crossing		<p>The words “must phone” may be varied to “must use SOS phone”</p> <p>— 45 min 75 max</p> <p>— 30 min 50 max</p>	1, 2, 7	
5	Diagram 652  One-way traffic	<p>300 450</p> 		7	1
6	Diagram 960.1  One-way road with a mandatory contraflow cycle lane		<p>The number of upward pointing arrows may be varied to indicate the number of lanes available to all traffic</p> <p>465 570</p>		1
7	Diagram 960.2  One-way road with contraflow pedal cycles	 <p>475 570</p>			1
8	Diagram 960  One-way road with a contraflow bus and cycle lane		<p>1. The number of upward pointing arrows may be varied to indicate the number of lanes available to all traffic</p> <p>450 540</p> <p>2. The cycle symbol may be omitted and the downward pointing</p>		1

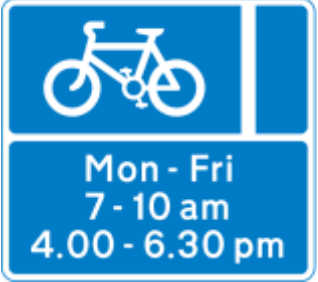
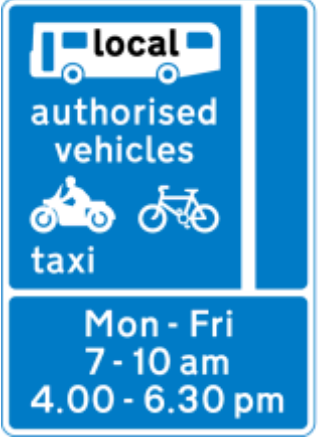

**Status:** This is the original version (as it was originally made). This item of legislation is currently only available in its original format.

(1) Item	(2) Description	(3) Diagram	(4) Permitted variants	(5) Applicable provisions in Part 8	(6) Schedule 8 General Directions
			arrow centred below the bus symbol  3. The bus symbol may be varied to the local bus symbol shown in the diagram at item 10		
9	Diagram 959.1  With-flow cycle lane with indication of times of operation		1. In the upper panel—  (a) the position of the vertical line and symbol may be varied to reflect the layout of the road marking at item 7 in the sign table in Part 6; and  (b) an additional vertical line may be added  2. The time period may be varied  3. The bottom panel may be omitted		
10	Diagram 959B  Nearside with-flow bus lane, which authorised vehicles, taxis, solo motor cycles and pedal cycles may also use, with indication of times of operation		1. In the upper panel—  (a) “authorised vehicles” or “taxi” or both may be omitted;  (b) the solo motor cycle symbol may be omitted;  (c) the local bus symbol may be varied to the bus symbol shown at item 8;  (d) the position of the vertical line and symbols may be varied to reflect the layout of the road marking at item 11 in the sign table in Part 6; and		1

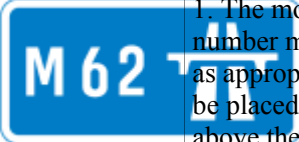
**Status:** This is the original version (as it was originally made). This item of legislation is currently only available in its original format.

(1) Item	(2) Description	(3) Diagram	(4) Permitted variants	(5) Applicable provisions in Part 8	(6) Schedule 8 General Directions
			<p>(e) an additional vertical line may be added</p> <p>2. The time period may be varied</p> <p>3. The bottom panel may be omitted</p>		
11	<p>Diagram 964</p> <p>End of with-flow bus lane</p>				1
12	<p>Diagram 2602.3</p> <p>The number of a route for pedal cycles forming part of a national or regional cycle route network</p>		<p>1. The route number may be varied as appropriate and may include capital letters</p> <p>2. The route number may be shown in brackets</p> <p>3. Additional route numbers, in brackets, may be shown</p> <p>4. The background colour may be varied to blue when placed on a regional cycle route</p> <p>5. When indicating a route other than a national or regional cycle route network, the route number, background and border may be in any contrasting colours</p>		7
13	<p>Diagram 2901</p> <p>Regulations in force under section 17 of the 1984 Act start to</p>	<p>100 min —</p> <p>300 max —</p> 	<p>1. The motorway number may be varied as appropriate and may be placed centrally above the motorway symbol</p>	7	

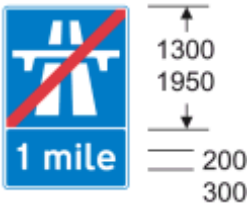
**Status:** This is the original version (as it was originally made). This item of legislation is currently only available in its original format.

(1) Item	(2) Description	(3) Diagram	(4) Permitted variants	(5) Applicable provisions in Part 8	(6) Schedule 8 General Directions
	apply to the road at this point		2. The motorway number may be shown in brackets  3. The motorway number may be expressed in the form “A 123 (M)” and “(M)” may be placed centrally below “A 123”		
14	Diagram 2930  Regulations referred to in this column in respect of item 13 cease to apply ahead	1300, 1950 	“1 mile” may be varied to “½ mile”	7	
15	Diagram 2931  Regulations referred to in this column in respect of item 13 cease to apply at this point	1300, 1950 		7	
16	Diagram 2932  Entrance to a motorway service area, maintenance compound or similar facility contained within a length of a motorway and indicating that Regulations in force under section 17 of the 1984 Act cease to apply at this point				

**Status:** This is the original version (as it was originally made). This item of legislation is currently only available in its original format.

## PART 5



### Provisions applicable to road markings in Part 6

1. The information, requirement, restriction or prohibition of a description in column 2 of an item in the sign table in Part 6 must be conveyed by a road marking that is of the size, colour and type shown in the diagram in column 3.
2. A provision of Part 8 applies to a sign provided for in Part 6 where indicated in column 4 of the table (by reference to a paragraph number in Part 8).
3. A Schedule 9 General Direction applies to a sign provided for in Part 6 where indicated in column 5 (by reference to a number equivalent to the general direction in Part 9).
4. Where “longitudinal marking” is mentioned in respect of an item in the table, the expression indicates a marking to be laid on the carriageway of a road longitudinally to the flow of traffic.

## PART 6

### Regulatory road markings

#### Sign table — Schedule 9, Part 6

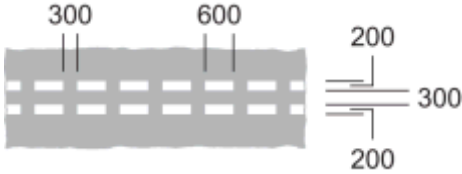
(1)	(2)	(3)	(4)	(5)
	<i>Item Description</i>	<i>Diagram</i>	<i>Applicable provisions in Part 8</i>	<i>Schedule 9 General Directions</i>
1	Diagram 1002.1 Vehicular traffic must not proceed beyond the line when required to stop by the stop sign		13	4
2	Diagram 1022 Approach to a road junction or level crossing at or near which is placed the marking at item 1 of this table and the stop sign		13	4
3	Diagram 1003A Vehicular traffic must give way in accordance with the requirements		1, 13	3



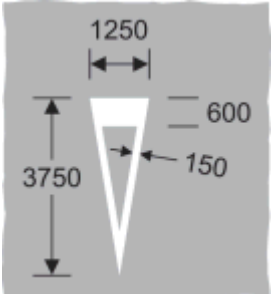
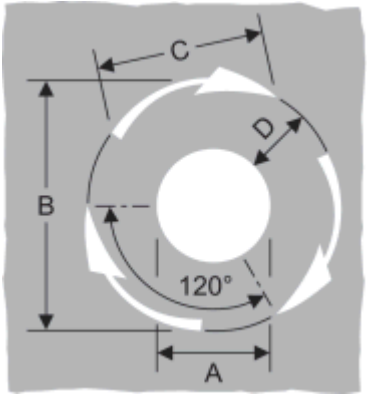
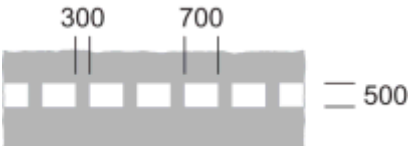

**Status:** This is the original version (as it was originally made). This item of legislation is currently only available in its original format.

(1) Item	(2) Description	(3) Diagram	(4) Applicable provisions in Part 8	(5) Schedule 9 General Directions
	in paragraph 7 of Part 7			
4	<p>Diagram 1023A</p> <p>Approach to a road junction, level crossing or road narrowing at or near which is placed the marking in item 3 or 6 of this table</p>		13	12
5	<p>Diagram 1003.4</p> <p>Marking used in conjunction with the sign at item 6 of the sign table in Part 2 for conveying the requirements in paragraph 5 of Part 7</p> <p>(Alternative sizes)</p>		<p>SIZE 14, 13</p> <p>A = 1000 min 2400 max</p> <p>B = 3500 min 7000 max</p> <p>C = 3025</p> <p>D = 1250 min</p> <p>SIZE 2</p> <p>A = 2500 min 4000 max</p> <p>B = 5000 min 10000 max</p> <p>C = 4450</p> <p>D = 1250 min</p>	6
6	<p>Diagram 1003.3</p> <p>Vehicular traffic approaching a roundabout with a small central island or approaching a junction indicated by the marking shown in item 5 of this sign table should give way at, or immediately beyond, the line to traffic circulating on the carriageway of the roundabout</p>		13	

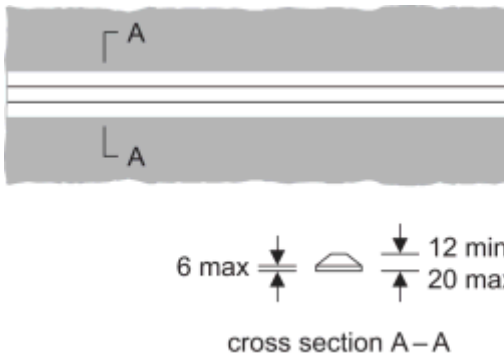
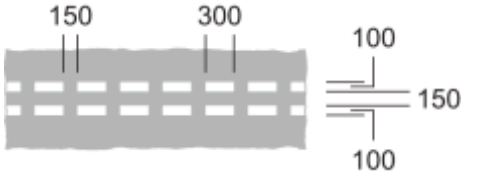
**Status:** This is the original version (as it was originally made). This item of legislation is currently only available in its original format.

(1) Item	(2) Description	(3) Diagram	(4) Applicable provisions in Part 8	(5) Schedule 9 General Directions
7	<p>Diagram 1049B</p> <p>Boundary of a mandatory cycle lane or division of a route into that part reserved for pedal cycles and that part reserved for pedestrians conveying the requirements at paragraph 12 of Part 7</p> <p>(Longitudinal marking)</p>		<p>1, 9</p> <p>= 150 200 250</p>	1
8	<p>Diagram 1049.1</p> <p>Division of a route into that part reserved for pedal cycles and that part reserved for pedestrians</p> <p>(Longitudinal marking)</p>	 <p>cross section A – A</p>	<p>6</p> <p>150 150 150</p>	1
9	<p>Diagram 1003B</p> <p>Cyclists must give way in accordance with the requirements prescribed in paragraph 8 of Part 7</p>		1	

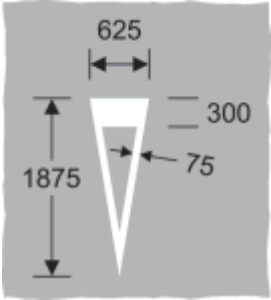

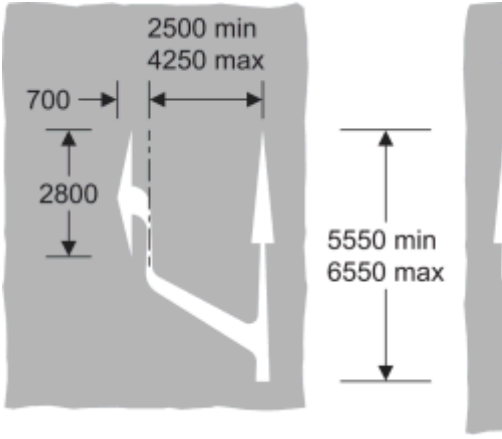
**Status:** This is the original version (as it was originally made). This item of legislation is currently only available in its original format.

(1) Item	(2) Description	(3) Diagram	(4) Applicable provisions in Part 8	(5) Schedule 9 General Directions
10	<p>Diagram 1023B</p> <p>Approach to a road junction on a cycle lane or track, or a place where cyclists must give way to pedestrians, at or near which is also placed the marking at item 9</p>			14
11	<p>Diagram 1049A</p> <p>Boundary of a bus lane or other designated lane used by motor vehicles</p> <p>(Longitudinal marking)</p>		13	1
12	<p>Diagram 1050</p> <p>Direction of possible traffic movements at the end of a nearside with-flow bus lane or other designated lane, or where there is an intermediate discontinuation of the lane on the approach to a junction</p> <p>(alternative types)</p>			1



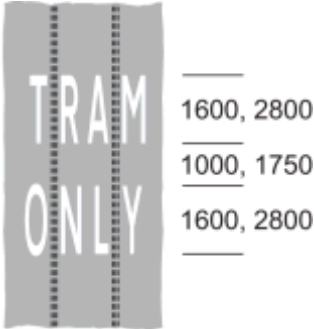

**Status:** This is the original version (as it was originally made). This item of legislation is currently only available in its original format.

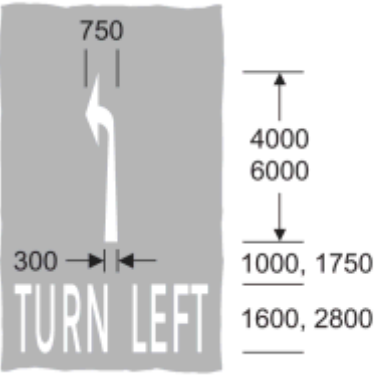
(1) Item	(2) Description	(3) Diagram	(4) Applicable provisions in Part 8	(5) Schedule 9 General Directions
13	<p>Diagram 1050.1</p> <p>Direction of possible traffic movements at the end of an off side with-flow bus lane or other designated lane, or where there is an intermediate discontinuation of the lane on the approach to a junction</p> <p>(alternative types)</p>			1
14	<p>Diagram 1048</p> <p>Traffic lane reserved for buses and other vehicles as indicated on the sign at item 8 or 10 in the sign table in Part 4</p>			1
15	<p>Diagram 1048.5</p> <p>Road or part of a road with access permitted only for buses and other vehicles when so indicated by any of the signs at items 10, 33 to 35 and 37 to 40 in the sign table in Part 2 of Schedule 3</p> <p>(Alternative types)</p>			1

**Status:** This is the original version (as it was originally made). This item of legislation is currently only available in its original format.

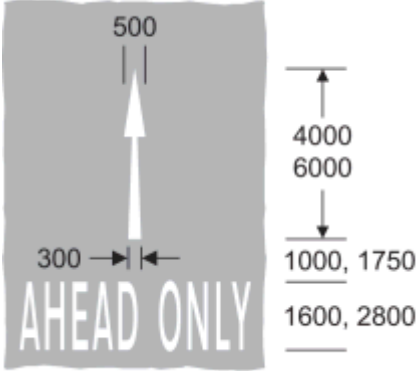
(1) Item	(2) Description	(3) Diagram	(4) Applicable provisions in Part 8	(5) Schedule 9 General Directions
16	Diagram 1048.2A  Road or part of a road with access permitted only for tramcars			1
17	Diagram 1046  No entry for vehicular traffic  (Alternative types)		13	1
18	Diagram 1046.1  Entry by vehicular traffic to a play street restricted  (Alternative types)		13	1
19	Diagram 1036.1  Vehicular traffic must turn left  (Alternative types)		13	1

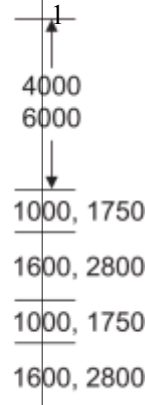
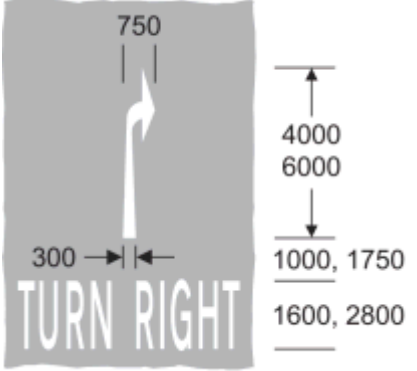
**Status:** This is the original version (as it was originally made). This item of legislation is currently only available in its original format.

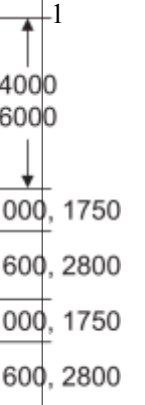
(1) Item	(2) Description	(3) Diagram	(4) Applicable provisions in Part 8	(5) Schedule 9 General Directions
20	Diagram 1036.2  Vehicular traffic must only proceed ahead  (Alternative types)		13  	1  
21	Diagram 1037.1  Vehicular traffic must turn right  (Alternative types)		13  	1  

**Status:** This is the original version (as it was originally made). This item of legislation is currently only available in its original format.

(1) Item	(2) Description	(3) Diagram	(4) Applicable provisions in Part 8	(5) Schedule 9 General Directions
22	<p>Diagram 1042</p> <p>Division of traffic lanes on a length of carriageway, or between the main carriageway and slip road, of a motorway or all-purpose dual carriageway road, or part of the carriageway between two lanes at a roundabout which vehicular traffic must not enter except in emergency</p> <p>(alternative types)</p>		1, 12, 13, 14	

**Status:** This is the original version (as it was originally made). This item of legislation is currently only available in its original format.

(1) Item	(2) Description	(3) Diagram	(4) Applicable provisions in Part 8	(5) Schedule 9 General Directions
23	Diagram 1013.1  Alternative methods of indicating to vehicular traffic the requirements and the warning in paragraphs 9 and 10 of Part 7	<p>Diagram 1013.1 illustrates four alternative methods (A, B, C, D) for indicating traffic requirements and warnings. Each method shows a road cross-section with travel directions indicated by arrows.</p> <ul style="list-style-type: none"> <li><b>Method A:</b> Shows a road with a central lane. Dimensions include a maximum width of 900 and a 100 min distance to the centerline. A 90 min distance is also indicated.</li> <li><b>Method B:</b> Shows a road with a central lane and a 45-degree angle. Dimensions include a maximum width of 1200, a 3000 max distance, and a 100 min distance to the centerline.</li> <li><b>Method C:</b> Shows a road with a central lane. Dimensions include a maximum width of 900 and a 100 min distance to the centerline. A 90 min distance is also indicated.</li> <li><b>Method D:</b> Shows a road with a central lane. Dimensions include a maximum width of 900, a 5000 distance, and a 1000 distance to the centerline. A 100 min distance is also indicated.</li> </ul>	1, 2, 10, 13	Schedule 9 General Directions



**Status:** This is the original version (as it was originally made). This item of legislation is currently only available in its original format.

(1) Item	(2) Description	(3) Diagram	(4) Applicable provisions in Part 8	(5) Schedule 9 General Directions
24	<p>Diagram 1013.5</p> <p>Division of traffic lanes on a length indicating to vehicular traffic the requirements in paragraph 9 of Part 7 and used in the circumstances for which the signs at items 17 to 20 in the Part 2 sign table in Schedule 11 are used</p>		1, 2, 11, 13	<p>1000 min</p> <p>150</p>
25	<p>Diagram 1043</p> <p>Marking conveying the requirements in paragraph 11 of Part 7</p>		1, 5	9

*Status: This is the original version (as it was originally made). This item of legislation is currently only available in its original format.*

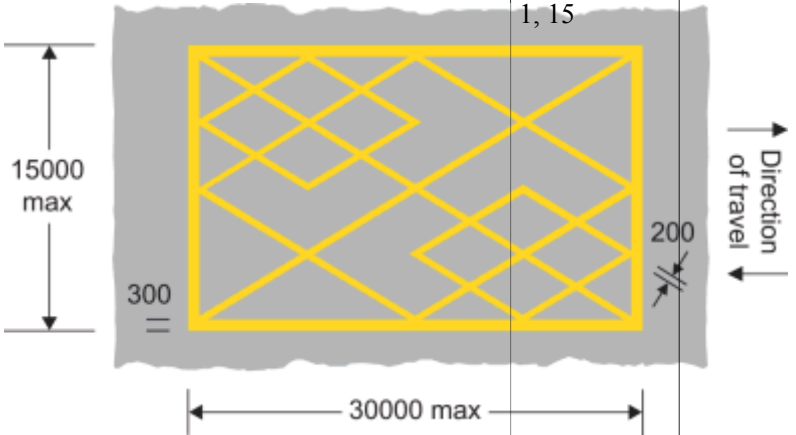
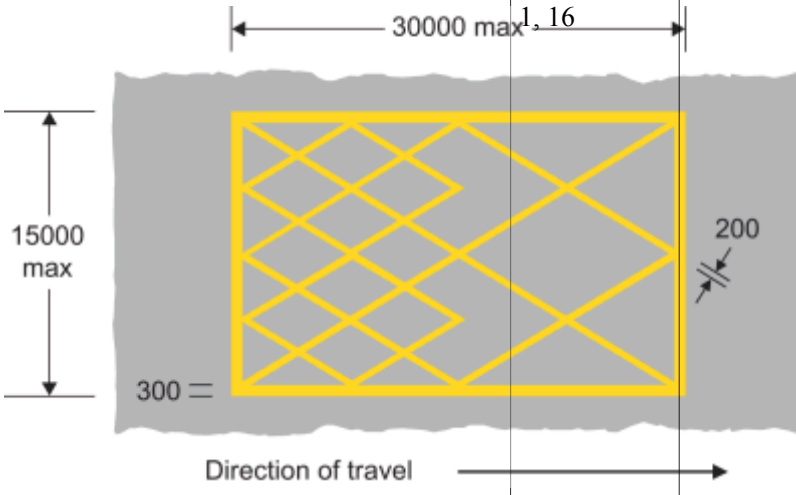
(1) Item	(2) Description	(3) Diagram	(4) Applicable provisions in Part 8	(5) Schedule 9 General Directions
26	<p>Diagram 1045</p> <p>Area of carriageway, subject to two-way traffic, at a level crossing which vehicles must not enter in a manner which then causes any part of the vehicle to remain at rest within the marked area due to the presence of stationary vehicles</p>		1, 15	
27	<p>Diagram 1045.1</p> <p>Area of carriageway, subject to one-way traffic, at a level crossing which vehicles must not enter in a manner which then causes any part of the vehicle to remain at rest within the marked area due to the presence of stationary vehicles</p>		1, 16	

## PART 7

### The significance of particular signs in Schedule 9

#### Stop sign

1. Subject to paragraph 2, the requirements conveyed to vehicular traffic on roads by a stop sign are that—

*Status: This is the original version (as it was originally made). This item of legislation is currently only available in its original format.*

- (a) every vehicle must stop before crossing the transverse line provided for at item 1 of the sign table in Part 6 of this Schedule, or if that line is not clearly visible, before entering the major road in respect of which the stop sign has been provided; and
  - (b) no vehicle must cross the transverse line, or if that line is not clearly visible, enter the major road in respect of which the stop sign has been provided, so as to be likely to endanger any person, or to cause the driver of another vehicle to change its speed or course in order to avoid an accident.
2. The requirements conveyed to vehicular traffic on roads by a stop sign when placed at a level crossing are that—
- (a) every vehicle must stop before crossing the transverse line, or if that line is not clearly visible, before entering the level crossing; and
  - (b) no vehicle must cross the transverse line, or if that line is not clearly visible, enter the level crossing so as to be likely to endanger the driver of, or any passenger in, any railway vehicle or tramcar or to cause that driver to change speed in order to avoid an accident.

#### **Give way sign**

3. Subject to paragraph 4, the requirements conveyed to vehicular traffic on roads by a give way sign are that no vehicle is to cross the transverse line provided for at item 3 of the sign table in Part 6 of this Schedule nearer to the major road at the side of which that line is placed, or if that line is not clearly visible, enter that major road, so as to be likely to endanger any person, or to cause the driver of another vehicle to change its speed or course in order to avoid an accident.

4. The requirements conveyed to vehicular traffic on roads by a give way sign when placed in combination with the sign at item 4 or 5 of the sign table in Part 2 of this Schedule are that no vehicle must cross the transverse line nearer to the level crossing at the side of which that line is placed, or if that line is not clearly visible, enter that level crossing, so as to be likely to endanger the driver of, or any passenger in, any railway vehicle or tramcar or to cause that driver to change the speed of his or her vehicle in order to avoid an accident.

#### **Priority to right sign**

5.—(1) The requirements conveyed to vehicular traffic on roads by a sign provided for at item 6 of the sign table in Part 2 of this Schedule are that—

- (a) a vehicle entering the junction must give priority to vehicles coming from the right—
  - (i) at the transverse road marking provided for at item 6 of the sign table in Part 6 of this Schedule;
  - (ii) at the transverse road marking provided for at item 3 of the sign table in Part 6 of this Schedule; or
  - (iii) if a marking is not for the time being visible, at the junction;
- (b) a vehicle proceeding through the junction must keep to the left of the white circle at the centre of the marking provided for at item 5 of the sign table in Part 6 of this Schedule (“the diagram 1003.4 marking”), unless the size of the vehicle or the layout of the junction makes it impracticable to do so; and
- (c) no vehicle is to proceed past the diagram 1003.4 marking in a manner, or at a time, likely to endanger any person, or to cause the driver of another vehicle to change its speed or course in order to avoid an accident.

*Status: This is the original version (as it was originally made). This item of legislation is currently only available in its original format.*

### **Permission to cross sign**

6.—(1) Subject to sub-paragraph (2) the requirements conveyed to vehicular traffic on roads by a sign provided for at item 4 of the sign table in Part 4 of this Schedule are that no abnormal transport unit is to proceed onto or over a level crossing unless—

- (a) the driver of the unit has used a telephone provided at or near the crossing for the purpose of obtaining from a person, authorised in that behalf by the railway or tramway authority, permission for the unit to proceed;
  - (b) that permission has been obtained before the unit proceeds; and
  - (c) the unit proceeds in accordance with any terms attached to that permission.
- (2) Sub-paragraph (1)(b) and (c) does not apply if—
- (a) the driver uses the telephone at the crossing and receives an indication for not less than two minutes that the telephone at the other end of the telephone line is being called, but no duly authorised person answers it, or the driver receives no indication at all due to a fault or malfunction of the telephone; and
  - (b) the driver then drives the unit on to the crossing with the reasonable expectation of crossing it within times specified in a railway or tramway notice at the telephone as being times between which railway vehicles or trams do not normally travel over that crossing.

### **Give way marking**

7. The requirements conveyed to vehicular traffic on roads by a road marking provided for at item 3 of the sign table in Part 6 of this Schedule are—

- (a) except as provided in paragraphs (b) to (d), that no vehicle may proceed past the transverse line which is the nearer to the major road into that road in a manner or at a time likely to endanger the driver of, or any passenger in, a vehicle on the major road or to cause the driver of such a vehicle to change its speed or course in order to avoid an accident;
- (b) where the transverse lines are placed at a level crossing, that no vehicle may proceed past such one of those lines as is the nearer the level crossing in a manner or at a time likely to endanger the driver of, or any passenger in, a railway vehicle or tramcar, or to cause that driver to change the speed of his or her vehicle in order to avoid an accident;
- (c) where the transverse lines are placed in advance of a point in the road where the width of the carriageway narrows significantly, that no vehicle may proceed past such one of those lines as is nearer to the point of narrowing in a manner or at a time likely to endanger the driver of, or any passenger in, a vehicle that is proceeding in the opposite direction to the first-mentioned vehicle, or cause the driver of such a vehicle to change its speed or course in order to avoid an accident;
- (d) where the transverse lines are placed in advance of a length of the carriageway of the road where a cycle track crosses the road along a route parallel to the transverse lines, that no vehicle may proceed past such one of those lines as is the nearer the cycle track, in a manner or at a time likely to endanger any cyclist proceeding along the cycle track or to cause such a cyclist to change speed or course in order to avoid an accident.

### **Cyclists to give way**

8. A cycle must not be ridden across the transverse line provided for at item 9 of the sign table in Part 6 of this Schedule in a manner or at a time that is likely to endanger any person, or to cause the driver of another vehicle to change its speed or course in order to avoid an accident.

### **No stopping or crossing white line marking**

9.—(1) The requirements conveyed to vehicular traffic on roads by a road marking provided for at items 23 and 24 of the sign table in Part 6 of this Schedule are that—

- (a) subject to sub-paragraphs (2) to (4), no vehicle is to stop on any length of road along which the marking has been placed at any point between the ends of the marking; and
- (b) subject to sub-paragraph (5), every vehicle proceeding on any length of road along which the marking has been so placed, as viewed in the direction of travel of the vehicle, a continuous line is on the left of a broken line or of another continuous line, must be so driven as to keep the first-mentioned continuous line on the right hand or off side of the vehicle.

(2) Nothing in sub-paragraph (1)(a) applies so as to prevent a vehicle stopping on any length of road so long as may be necessary for any of the purposes specified in sub-paragraph (3) if the vehicle cannot be used for such a purpose without stopping on the length of road.

(3) The purposes are—

- (a) to enable a person to board or alight from the vehicle,
- (b) to enable goods to be loaded on to or to be unloaded from the vehicle,
- (c) to enable the vehicle to be used in connection with—
  - (i) any operation involving building, demolition or excavation;
  - (ii) the removal of any obstruction to traffic;
  - (iii) the maintenance, improvement or reconstruction of the length of road; or
  - (iv) the laying, erection, alteration, repair or cleaning in or near the length of road of any sewer or of any main, pipe or apparatus for the supply of gas, water or electricity, or of any electronic communications apparatus kept installed for the purposes of an electronic communications code system or of any other electronic communications apparatus lawfully kept installed in any position.

(4) Nothing in sub-paragraph (1)(a) applies—

- (a) so as to prevent a vehicle stopping in a lay-by;
- (b) to a vehicle being used for at least one of the following purposes—
  - (i) fire and rescue authority;
  - (ii) Scottish Fire and Rescue Service;
  - (iii) traffic officer;
  - (iv) ambulance;
  - (v) providing a response to an emergency at the request of an NHS ambulance service;
  - (vi) bomb or explosive disposal;
  - (vii) special forces;
  - (viii) police; and
  - (ix) National Crime Agency.
- (c) to a pedal cycle;
- (d) to a vehicle stopping in any case where the person in control of the vehicle is required by law to stop, or is obliged to do so in order to avoid an accident, or is prevented from proceeding by circumstances outside the person's control;
- (e) to anything done with the permission or at the direction of a constable in uniform, traffic officer in uniform or in accordance with the direction of a traffic warden; or

*Status: This is the original version (as it was originally made). This item of legislation is currently only available in its original format.*

(f) to a vehicle on a road with more than one traffic lane in each direction.

(5) Nothing in sub-paragraph (1)(b) is to be taken to prohibit a vehicle from being driven across, or so as to straddle, the continuous line referred to in that paragraph, if it is safe to do so and if necessary to do so—

- (a) to enable the vehicle to enter, from the side of the road on which it is proceeding, land or premises adjacent to the length of road on which the line is placed, or another road joining that road;
- (b) in order to pass a stationary vehicle;
- (c) owing to circumstances outside the control of the driver;
- (d) in order to avoid an accident;
- (e) in order to pass a road maintenance vehicle which is in use, is moving at a speed not exceeding 10 mph, and is displaying to the rear a sign provided for at item 9 or 10 of the sign table in Part 6 of Schedule 13;
- (f) in order to pass a pedal cycle moving at a speed not exceeding 10 mph;
- (g) in order to pass a horse that is being ridden or led at a speed not exceeding 10 mph; or
- (h) for the purposes of complying with any direction of a constable in uniform, a traffic officer in uniform or a traffic warden.

**10.** The warning conveyed to vehicular traffic on roads by the road marking provided for at item 23 of the sign table in Part 6 of this Schedule is that no vehicle while travelling next to a broken line placed on the left of a continuous line, as viewed in the direction of travel of the vehicle, should cross or straddle the first-mentioned line unless it is seen by the driver of the vehicle to be safe to do so.

### **Box junctions**

**11.—**(1) Subject to sub-paragraphs (2), (3) and (4), the yellow criss-cross marking provided for at item 25 of the sign table in Part 6 conveys the prohibition that a person must not cause a vehicle to enter the box junction so that the vehicle has to stop within the box junction due to the presence of stationary vehicles.

(2) Subject to sub-paragraph (4) the marking when placed as a box junction within sub-paragraph (6)(c) of the definition of that expression conveys the prohibition that a person must not cause a vehicle to enter the box junction so that the vehicle has to stop within the box junction due to the presence of oncoming vehicles or other stationary vehicles beyond the box junction.

(3) The prohibition in sub-paragraph (1) does not, in respect of a box junction within sub-paragraph (6)(a) of the definition of that expression, apply to a person who—

- (a) causes a vehicle to enter the box junction for the purpose of turning right; and
- (b) stops the vehicle within the box junction for so long as the vehicle is prevented from completing the right turn by an oncoming vehicle or other vehicle which is stationary whilst waiting to complete a right turn.

(4) When a vehicle is being used for at least one of the purposes mentioned at sub-paragraph (5) and the observance of the prohibition in sub-paragraph (1) or (2) would be likely to hinder the use of that vehicle for that purpose, then that prohibition does not apply to the driver of the vehicle.

(5) The purposes are—

- (a) fire and rescue authority;
- (b) Scottish Fire and Rescue Service;
- (c) ambulance;
- (d) providing a response to an emergency at the request of an NHS ambulance service;

- (e) bomb or explosive disposal;
- (f) special forces;
- (g) police; and
- (h) National Crime Agency.

(6) For the purposes of this paragraph “box junction” means an area of the carriageway where the marking has been placed and which is—

- (a) at a junction between two or more roads;
- (b) at a gyratory system or roundabout;
- (c) along a length of a two-way road (other than at a junction), the carriageway of which is not greater than 4.5 metres wide at its narrowest point; or
- (d) on the length of road adjacent to the vehicular entrance to the premises of a fire, police or ambulance station; and

(7) A reference in this paragraph (however expressed) to a vehicle which is stationary or stops within a box junction includes a vehicle which is stationary whilst part of it is within the box junction.

#### **Mandatory with flow cycle lanes**

**12.—**(1) This paragraph applies to the road marking provided for at item 7 of the sign table in Part 6—

- (a) when that marking is being used to separate a cycle lane from another part of the carriageway; and
- (b) where the direction of travel along the cycle lane and the part of the carriageway from which it is separated is the same.

(2) Subject to sub-paragraphs (3) to (5), the marking conveys the requirement that a vehicle, other than a pedal cycle, must not be driven, or ridden, in the cycle lane during the cycle lane’s hours of operation (which may be all the time).

(3) Sub-paragraph (2) does not prohibit a vehicle from crossing into the part of the carriageway reserved for pedal cycles, or straddling the marking, if it is safe and necessary to do so—

- (a) in order to pass a stationary vehicle;
- (b) to enable the vehicle to enter, from the side of the road on which it is proceeding, land or premises adjacent to the length of road on which the line is placed, or another road joining that road;
- (c) due to circumstances outside the control of the driver;
- (d) in order to avoid an accident; or
- (e) for the purpose of complying with any direction of a constable in uniform or a traffic warden.

(4) When a vehicle is being used for at least one of the purposes mentioned at sub-paragraph (5) and the observance of the prohibition in sub-paragraph (2) would be likely to hinder the use of the vehicle for that purpose, then that prohibition does not apply to the driver of the vehicle.

(5) The purposes are—

- (a) fire and rescue authority;
- (b) Scottish Fire and Rescue Service;
- (c) ambulance;
- (d) providing a response to an emergency at the request of an NHS ambulance service;
- (e) bomb or explosive disposal;

*Status: This is the original version (as it was originally made). This item of legislation is currently only available in its original format.*

- (f) special forces;
- (g) police; and
- (h) National Crime Agency.

## PART 8

### Provisions applicable to signs in Parts 2, 4 and 6

1.—(1) Subject to sub-paragraph (2), section 36 of the 1988 Act applies to the sign.

(2) Sub-paragraph (1) applies to the sign provided for at item 7 of the Part 6 sign table only where that marking is used to indicate the boundary of a mandatory with-flow cycle lane during the cycle lane's hours of operation (which may be all the time).

2. The sign is specified for the purposes of column 5 of the entry in Schedule 2 to the Road Traffic Offenders Act 1988(1) relating to offences under section 36 of the 1988 Act.

3. Where the sign is placed temporarily on a road by a constable or person acting under the instructions (whether general or specific) to the chief officer of police for the purposes of indicating a temporary statutory provision, the diameter may be reduced to not less than 200 mm.

4. The central part of the road marking must not project above the surface of the adjacent carriageway more than 125 mm at its highest point or 6 mm at its perimeter.

5.—(1) The overall shape and size of the road marking, within the overall dimensions shown, may be varied as appropriate.

(2) Parts of a boundary line may be omitted when the edge of the marking is adjacent to a raised kerb.

(3) Parts of the marking may be omitted where tram rails cross the marking.

(4) Parts of the marking may be omitted to indicate the edge of the path taken by a tramcar and, where parts of the marking are so omitted, the remaining parts must be bounded by a continuous yellow line.

6. The height of the marking above the surface of the adjacent carriageway must be within the range of dimensions indicated on the lower part of the diagram at item 8 of Part 6 in illustrating the cross-section of the marking.

7.—(1) Subject to sub paragraph (2), where the sign is placed on a road subject to a speed limit greater than 20 mph and is within 50 metres of any lamp which forms part of a system of street-lighting, the illumination requirements are—

- (a) where that system of street-lighting is illuminated throughout the hours of darkness, the sign must be illuminated by internal or external lighting for so long as that system is illuminated and may also be reflectorised; or
- (b) where that system of street-lighting is not illuminated throughout the hours of darkness—
  - (i) the sign must be illuminated by internal or external lighting for so long as that system is illuminated and must also be reflectorised; or
  - (ii) the sign must be illuminated throughout the hours of darkness by internal or external lighting and may also be reflectorised.

---

(1) 1988 c. 53.



(2) Sub paragraph (1) applies to the sign at item 5 of the Part 4 table only when placed within 50 metres of any junction with another road from which traffic can approach it.

8. The sign need not be illuminated.

9. The road marking must be reflectorised where indicating the boundary of a mandatory cycle lane.

10.—(1) When the road marking is used, studs must also be placed.

(2) The studs must incorporate—

- (a) white reflectors;
- (b) white retroreflecting material;
- (c) a light source that emits, during the hours of darkness, a steady white light; or
- (d) any combination.

(3) In the case of the markings shown in parts A and C of the diagram, the studs must be fitted as a single line between the continuous line and the non-continuous line of the marking and be spaced not less than 3 metres nor more than 4.5 metres apart.

(4) In the case of the marking shown in in part B of the diagram, the studs must be fitted either in opposite pairs within the width of each of the two lines that run longitudinally to the flow of traffic or as a single line between those lines and in either case the studs must be placed not less than 3 metres nor more than 4.5 metres from the nest stud in the line.

(5) In the case of the marking shown in part D of the diagram, the studs must form a single line between the continuous line and the non-continuous line of the marking and be spaced not less than 3 metres nor more than 4.5 metres apart and the direction of the line of studs is not to be changed by reason of the switching of the continuous and non-continuous lines of the marking as shown in the diagram at that part.

(6) The external part of the stud that is visible when the stud is in place must be—

- (a) white;
  - (b) of a natural metallic finish;
  - (c) of another neutral colour; or
  - (d) clear,
- or any combination (but see sub-paragraph (7) for an exception).

(7) The external part of a stud that is visible when the stud is in place temporarily during road works must be fluorescent green-yellow except to the extent—

- (a) it consists of white reflectors or retroreflecting material; or
- (b) it is necessary for it to be a different colour or clear in order for the stud to emit white light.

11.—(1) When the marking is used, studs must also be placed.

(2) The studs must incorporate—

- (a) white reflectors;
  - (b) white retroreflecting material; or
  - (c) a light source that emits, during the hours of darkness, a steady white light,
- or any combination.

(3) The studs must be fitted in opposite pairs within the width of each of the two lines that run longitudinally to the flow of traffic and the studs must be placed not less than 3 metres nor more than 4.5 metres apart.

*Status: This is the original version (as it was originally made). This item of legislation is currently only available in its original format.*

- (4) The external part of the stud that is visible when the stud is in place must be—
    - (a) white;
    - (b) of a natural metallic finish;
    - (c) of another neutral colour; or
    - (d) clear,or any combination (but see sub-paragraph (5) for an exception).
  - (5) The external part of a stud that is visible when the stud is in place temporarily during road works must be fluorescent green-yellow except to the extent—
    - (a) it consists of white reflectors or retroreflecting material; or
    - (b) it is necessary for it to be a different colour or clear in order for the stud to emit white light.
- 12.**—(1) When the marking is used, studs may also be placed.
- (2) The studs must incorporate—
    - (a) red reflectors;
    - (b) red retroreflecting material; or
    - (c) a light source that emits, during the hours of darkness, a steady red light,or any combination.
  - (3) The studs must be fitted at the side of, and adjacent to the solid line forming the boundary of the marking.
  - (4) The external part of the stud that is visible when the stud is in place must be—
    - (a) red
    - (b) white;
    - (c) of a natural metallic finish;
    - (d) of another neutral colour; or
    - (e) clear,or any combination (but see sub-paragraph (5) for an exception).
  - (5) The external part of a stud that is visible when the stud is in place temporarily during road works must be fluorescent green-yellow except to the extent—
    - (a) it consists of red reflectors or retroreflecting material; or
    - (b) it is necessary for it to be a different colour or clear in order for the stud to emit red light.
- 13.** The road marking must be reflectorised.
- 14.** The road marking may, except at a roundabout, be varied by replacing the boundary line with the marking at item 12 or 13 of the sign table in Part 4 of Schedule 11.
- 15.** The road marking may be varied as follows—
  - (a) the pattern of diagonal lines on each side of the level crossing may be extended longitudinally within the limit of the marking by increasing the number of diamond shapes on the approach side and the number of diagonal crosses on the leaving side; and
  - (b) parts of the marking may be omitted to accommodate the road markings at—
    - (i) diagram A of item 23 in the Part 6 sign table; or
    - (ii) item 2 or 3 of the sign table in Part 4 of Schedule 11.
- 16.** The road marking may be varied as follows—

*Status: This is the original version (as it was originally made). This item of legislation is currently only available in its original format.*

- (a) the pattern of diagonal lines on each side of the level crossing may be extended longitudinally within the limit of the marking by increasing the number of diamond shapes on the approach side and the number of diagonal crosses on the leaving side; and
- (b) parts of the marking may be omitted to accommodate the road markings at item 2 or 3 of the sign table in Part 4 of Schedule 11.

## PART 9

### The Schedule 9 General Directions

**1.**—(1) Subject to sub-paragraph (2), the sign must only be placed to indicate the effect of an Act, order, regulation, bylaw, resolution or notice which prohibits or restricts the use of the road by traffic.

(2) Sub-paragraph (1) does not apply to the sign provided for at item 7 of the Part 6 sign table where the sign is used to indicate the boundary of a mandatory with-flow cycle lane.

**2.** The sign must only be placed to indicate the effect of a statutory provision which restricts the use of the road carried by a bridge or other structure—

- (a) in the case of vehicles required to be marked with their maximum gross weight, to any vehicle with a maximum gross weight not exceeding that indicated on the sign; or
- (b) in the case of vehicles not required to be marked with their maximum gross weight but required to be marked with their unladen weight, to any vehicle with an unladen weight not exceeding the gross weight indicated on the sign.

**3.** The sign may only be placed at a junction with another road if the same sign has not been placed on the other road so as to control traffic passing through the junction on that other road.

**4.**—(1) The stop sign must only be placed in conjunction with the road markings at items 1 (“the diagram 1002.1 marking”) and 2 (“the diagram 1022 marking”) of the sign table in Part 6.

(2) The diagram 1002.1 marking must only be placed in conjunction with the stop sign and the diagram 1022 marking.

(3) The diagram 1022 marking must only be placed in conjunction with the stop sign and the diagram 1002.1 marking.

**5.** The sign provided for at item 2 of the sign table in Part 2 must only be placed in conjunction with the road markings at items 3 and 4 of the sign table in Part 6.

**6.**—(1) The sign provided for at item 6 in the sign table in Part 2 must only be placed in conjunction with—

- (a) the road markings provided for at item 5 and 6 of the sign table in Part 6; or
- (b) the road markings shown in that sign table at items 3, 4 and 5 where the sign is placed in conjunction with the sign at item 2 in the sign table in Part 2.

(2) The road marking provided for at item 5 of the sign table in Part 6 must only be placed in conjunction with the sign at item 6 of the sign table in Part 2.

**7.** The sign must only be placed in conjunction with a sign at item 28, 29, 30, 31 and 32 of the sign table in Part 2 of Schedule 2.

**8.**—(1) The requirement in paragraph 4, 5 or 6 to place a relevant upright sign in conjunction with a relevant marking does not apply during the execution of works if—

- (a) those works necessitate the temporary removal of the marking; or

**Status:** This is the original version (as it was originally made). This item of legislation is currently only available in its original format.

- (b) the sign is placed only temporarily in connection with the execution of works on a road.
- (2) For the purposes of sub-paragraph (1) “relevant upright sign” and “relevant marking” mean—
  - (a) in the case of paragraph 4, the sign and marking referred to in that paragraph;
  - (b) in the case of paragraph 5, the sign and marking referred to in that paragraph; and
  - (c) in the case of paragraph 6, the sign and marking referred to in that paragraph.
- 9. The road marking must not be placed on an area of carriageway at a gyratory system or roundabout unless entry of traffic into that area of carriageway is at all times controlled by traffic light signals.
- 10. The sign must only be placed in combination with the sign at item 1 or 2 of the sign table in Part 2.
- 11. The sign must only be placed in combination with the sign at item 2 of the sign table in Part 2.
- 12. The road marking must only be placed in conjunction with the road marking at item 3 or 6 of the sign table in Part 6.
- 13. The back of the sign may be of any colour.
- 14. The road marking may only be placed in conjunction with the road marking at item 9 of the sign table in Part 6.